



# Fresh air valves / overflow units





About Lindab	1
Comfort and Design	2
Product overview / symbols	3
Theory	4
Ceiling diffusers	5
Ceiling diffusers - visible	6
Plenum boxes	7
Wall diffusers	8
Nozzles	9
Ventiduct	10
Grilles	11
Displacement diffusers	12
VAV	13
Air flow regulators	14
Air valves	15
<b>Fresh air valves/overflow units</b>	<b>16</b>
Cleanroom diffusers	17
Contents	18

# Fresh air valves / overflow units

## Fresh air valves

	Product	Functions	Page
	<b>ULA</b>		<b>641</b>
	<b>ULV</b>		<b>644</b>

## Overflow units

	Product	Functions	Page
	<b>OLC</b>		<b>647</b>
	<b>OLR</b>		<b>649</b>

- 1
- 2
- 3
- 4
- 5
- 6
- 7
- 8
- 9
- 10
- 11
- 12
- 13
- 14
- 15
- 16**
- 17
- 18

# Fresh air valves / overflow units



*ULA, summerhouse, Dronningmoelle.*

## Lindab fresh air valves

Fresh air valves are usually used in residences where mechanical supply air is not available, but there is still a need to ensure an air-change in the room.

The fresh air valve usually functions with a mechanical exhaust unit, where the volume of the exhaust air is replaced through the fresh air valve.

## Lindab overflow units

Overflow units are usually used in connection with the transfer of air between rooms. The overflow unit is able to balance two rooms, in connection with the supply of air in one room and exhaust air in a connecting room.



*ULA*



# Fresh air valve

# ULA



## Description

ULA is a circular fresh air valve with telescopic wall sleeve for installation in an external wall close to the roof. ULA has an integral damper that can be operated using a pull-cord. The special telescopic wall sleeve makes it possible to install the valve in the wall without screws. The two telescopic parts are screwed together through the wall. ULA can be supplied with two types of external grille, and type 1 is also equipped with detachable insect netting. ULA is supplied with sound insulation inserts in two thicknesses. The material is fibre-free, washable and easy to remove. ULA is supplied with an EU-3 filter. The insect netting and sound insulation can be easily removed from inside.

- Easy to clean
- Fits wall thicknesses from 250 mm to 430 mm
- Can be supplied with sound insulation inserts in two thicknesses
- External casing in several colours and materials

## Maintenance

Front plate, filter and insulation can be removed to enable cleaning.

## Accessories

- ULZ-1: Extra sound insulation (wall thickness > 300 mm)
- ULZ-2: Cover flange Ø 241 mm, galvanised steel, white/grey
- ULZ-3: Filter
- ULZ-4: Insect netting
- ULAK: Type 1, with copper casing
- ULAK: Type 1, with aluminium casing
- ULAG: Type 1, with galvanised casing

## Order code

Product	ULA	a
Type		
Outside grille 1,2		

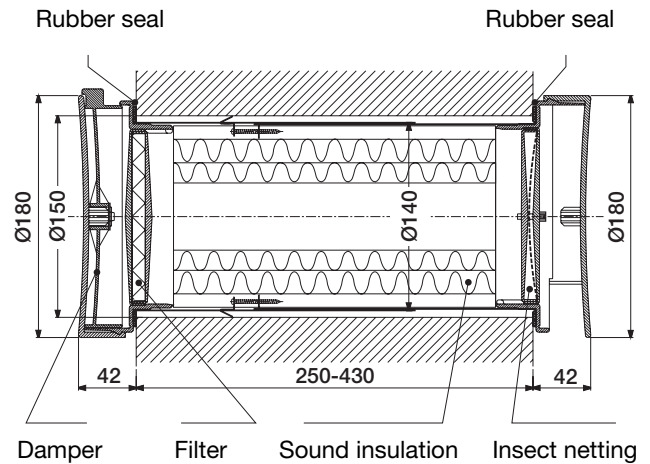

External grille type 1

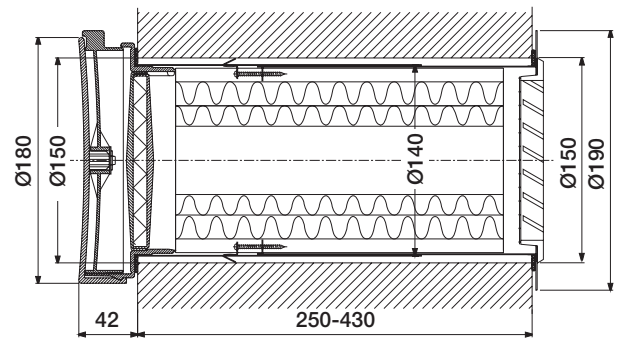
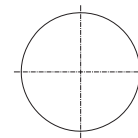

External grille type 2

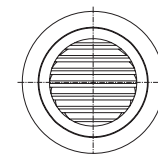

ULA is supplied with 2-part sound insulation insert Ø140/Ø50 mm. If greater capacity is required, remove the inner section of the insulation. Sound reduction will decrease by 3 dB (see tech. data). Valves with a shorter design for installation in lightweight structures can be supplied on request. However, this will result in reduced sound insulation.

## Materials and finish

Internal section:	Colourfast plastic
Standard colour:	White
External grille type 1:	Colourfast plastic, grey
External grille type 2:	Aluminium
Standard finish:	Powder-coated, Grey RAL 7040
Telescopic tube:	Galvanised steel
Sound insulation:	Foam plastic

# Fresh air valve

# ULA

## Technical data

### Capacity

Underpressure (Pa)

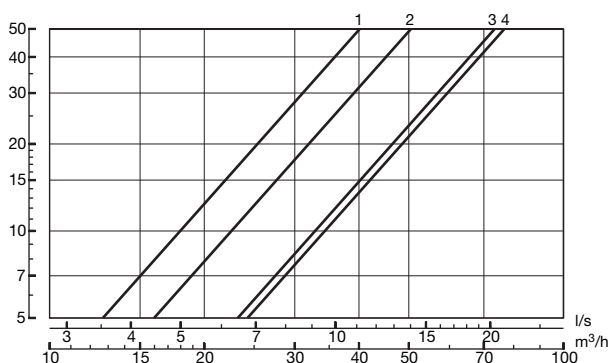

Dn,e (dB) Sound reduction

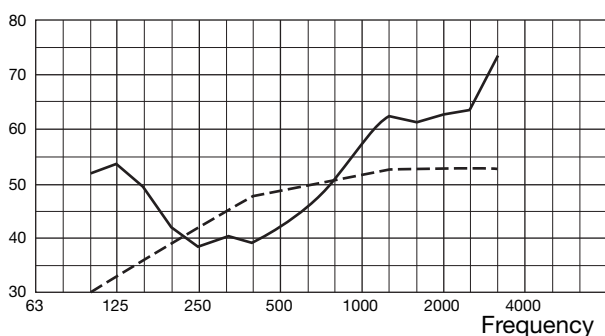

Dn,e (dB) Sound reduction

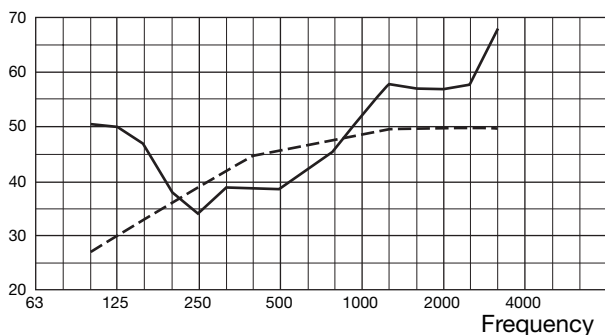

Dn,e (dB) Sound reduction

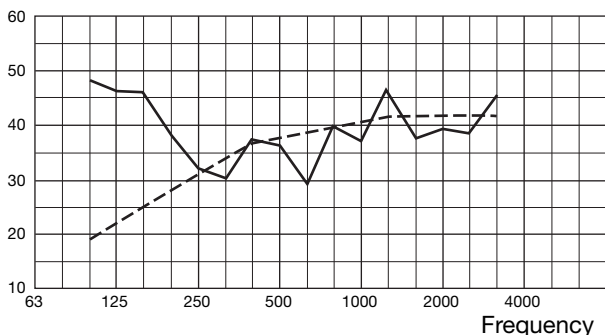

Curve	Filter	Sound-Insulation mm	free opening cm <sup>2</sup>	Equivalent area cm <sup>2</sup>
1	EU-3	Ø140 / Ø50	20	21
2	EU-3	Ø140 / Ø80	50	26
2	-	Ø140 / Ø50	20	26
3	-	Ø140 / Ø80	50	38
4	-	-	50	39

#### ULA with sound insulation Ø140/Ø50

**wall thickness: 300 mm**

Weighted element-normalised level difference  
Dn,e,w = 49 dB, Δmax = 8.3 dB

**49 (-1;-3) dB**

#### ULA with sound insulation Ø140/Ø80

**wall thickness: 300 mm**

Weighted element-normalised level difference  
Dn,e,w = 46 dB, Δmax = 7.6 dB

**46 (0;-3) dB**

#### ULA without sound insulation

**wall thickness: 300 mm**

Weighted element-normalised level difference  
Dn,e,w = 38 dB, Δmax = 10.2 dB

**38 (-1;-2) dB**

# Fresh air valve

# ULA

## Technical data

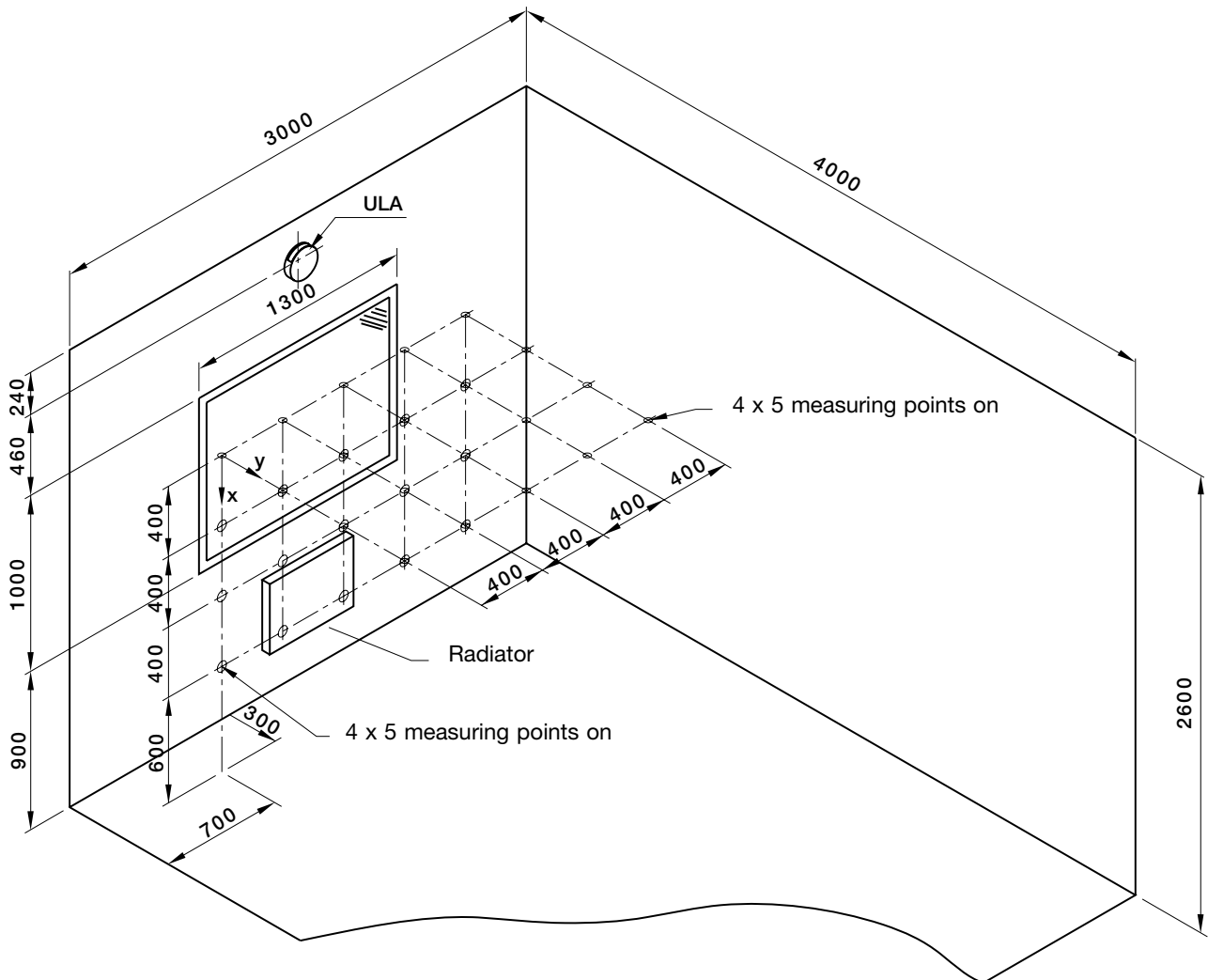

Air Flow		Without radiator (500W)			radiator (500W)	
m <sup>3</sup> /h	l/s	Δt (K)			Δt (K)	
		0	-20	-40	-20	-40
20	5,6	<0,10	0,15	0,21	<0,10	0,10
30	8,3	<0,10	0,15	0,22	<0,10	0,17
40	11,1	0,10	0,15	0,22	0,10	0,18
50	13,9	0,13	0,15	-	0,11	-
60	16,7	0,14	0,15	-	0,11	-
70	19,4	0,14	0,15	-	0,13	-
100	28,0	0,15	0,23	-	0,13	-

The drawing above shows a trial set-up for determination of speeds in the occupied zone for different volumes of air and temperature differences.

For trials with  $\Delta t = -40$  K, a window with  $U = 1.5$  W/m<sup>2</sup> was used. At  $-20$  K was  $U = 2.6$  W/m<sup>2</sup>.

- 1
- 2
- 3
- 4
- 5
- 6
- 7
- 8
- 9
- 10
- 11
- 12
- 13
- 14
- 15
- 16
- 17
- 18

# Fresh air valve

# ULV

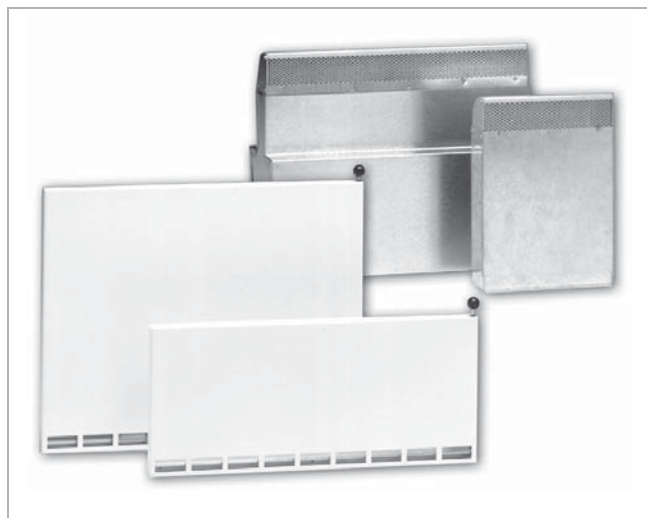

## Description

ULV is a rectangular fresh air valve for installation in external walls behind radiators. The valve is equipped with a damper that is opened and closed by means of a handle on the top. In order to achieve a good seal against the wall, the back of the valve is equipped with a sealing strip made of synthetic foam rubber. Three telescopic wall sleeve are available as accessories to the valves, including the sound-attenuated version. The valve can also be supplied with an extended damper arm. ULV is used for the intake of fresh air in connection with a mechanical exhaust system, whereby good utilisation of air jet and convection heat is achieved. ULV is typically used in homes and premises where there are requirements for a solution that is simple and economical to install. Valve type ULV2 should be selected where maximum heating is required.

- Excellent utilisation of air jet and convection heating
- Fits wall thicknesses from 230 mm to 440 mm
- Can be supplied with sound-insulated telescope
- Wall sleeve in brick dimensions

## Maintenance

The front panel can be removed from the wall rail to make cleaning possible. The visible parts of the diffuser can be wiped with a damp cloth.

## Order code

<b>Product</b>	<b>ULV</b>	<b>a</b>	<b>b</b>
Type			
Height			

### Accessories:

Without accessories	0
Telescopic wall sleeve 230 mm	1
Telescopic wall sleeve 470 mm	2
Sound-attenuated telescopic wall sleeve	3

## Dimensions

### ULV-1

Weight 1.9 kg

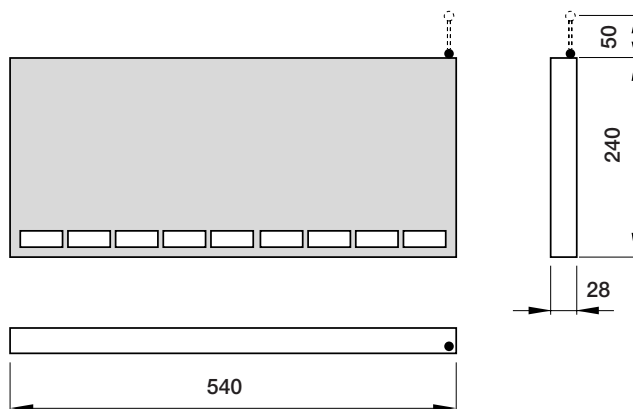

### ULV-2

Weight 3.2 kg

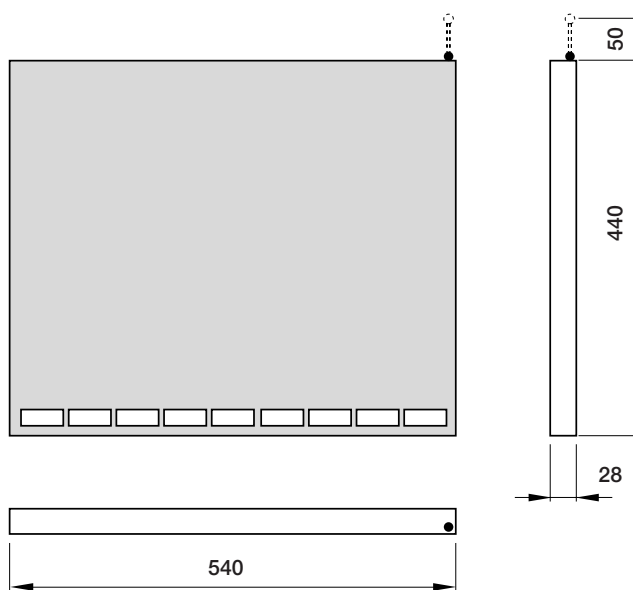

## Materials and finish:

Valve:	Galvanised steel plate with aluminium damper
Wall sleeve:	Galvanised steel plate with aluminium insert
Sound insulation:	Melamine foam plastic
Standard colour:	Powder-coated RAL 9010 white

The diffuser is available in other colours. Please contact Lindab's sales department for further information.



# Fresh air valve

# ULV

## Mounting

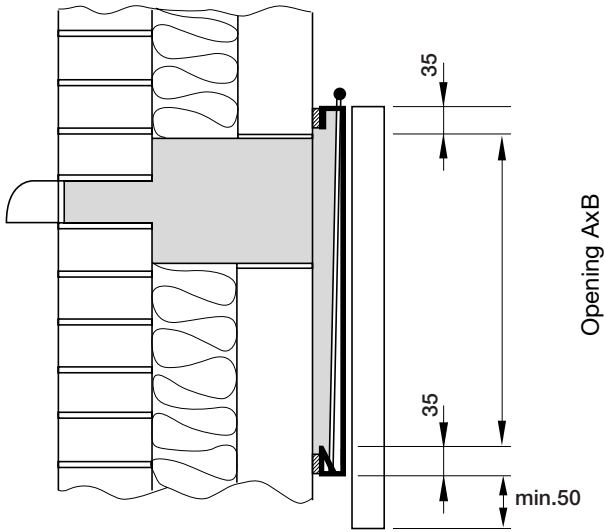

The accompanying installation rail should be fastened to the wall. The fresh air valve is suspended from the rail and fastened to it by means of screws through the lower edge of the front plate.

	A mm	B mm
ULV-1	170	510
ULV-2	370	510

### Width of wall sleeve:

230 mm corresponds to one brick  
470 mm corresponds to two bricks

## Accessories

- 1) Telescopic wall sleeve  
Width 230 mm. Weight 2.0 kg

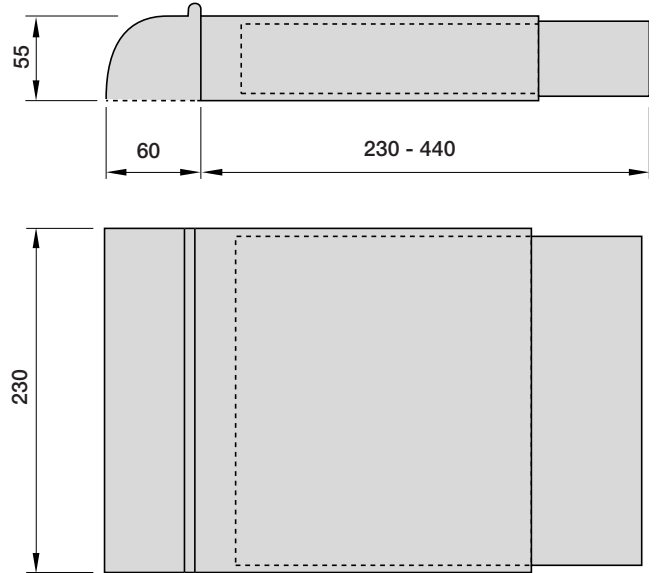

- 2) Telescopic wall sleeve  
Width 470 mm. Weight 3.8 kg

- 3) Sound-attenuated telescopic wall sleeve  
Weight: 4.7 kg

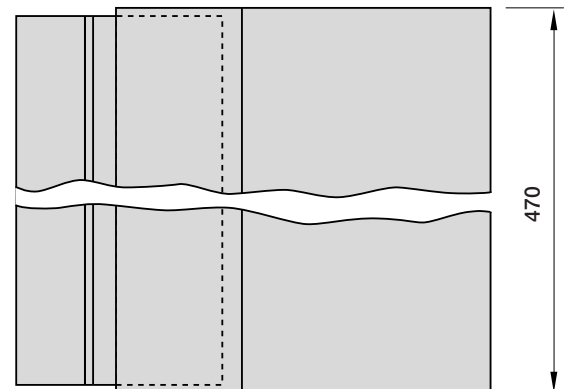
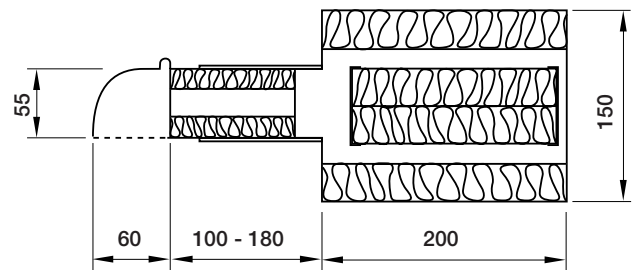

Extended damper arm.

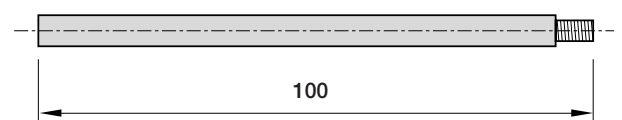

1

2

3

4

5

6

7

8

9

10

11

12

13

14

15

16

17

18

# Fresh air valve

# ULV

## Technical data

### Capacity

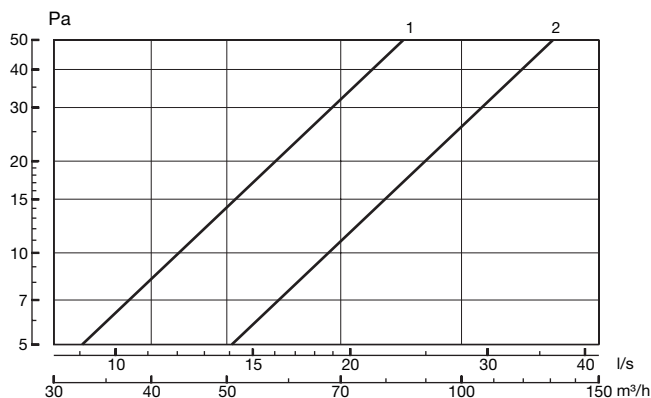

1. ULV with wall sleeve type 1.
2. ULV with wall sleeve types 2 and 3.

### Sound reduction

#### ULV with wall sleeve type 3

Weighted element-normalised level difference

$D_{n,e,w} = 48 \text{ dB}$ ,  $\Delta_{\text{max}} = 8.6 \text{ dB}$

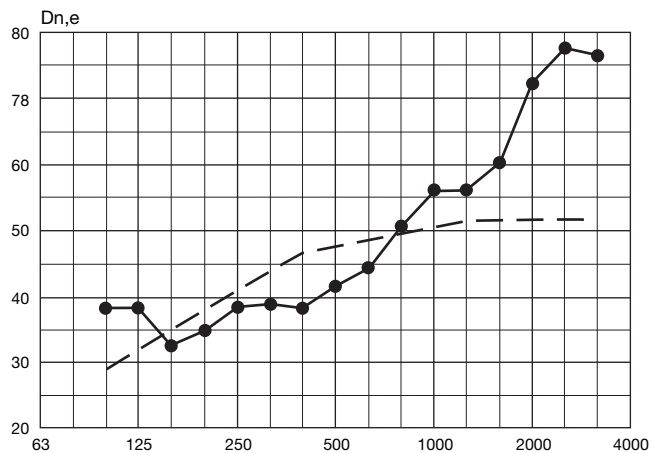

The sound insulation measurements were undertaken by DELTA & Vibration, in accordance with the testing instructions in DS/ISO 140-3:1978

# Pressure control valve

# OLC



## Description

OLC is a circular pressure control valve for installation directly onto a wall. OLC consists of two sound-attenuating baffles, which are mounted either side of the wall and are connected by means of the accompanying perforated wall sleeve, which ensures excellent noise reduction.

- Discrete design
- Sound-attenuating baffles
- Can be installed in wall thicknesses from 90-170 mm

## Maintenance

Front plate can be removed to enable cleaning of internal parts. The visible parts of the diffuser can be wiped with a damp cloth.

## Dimensions

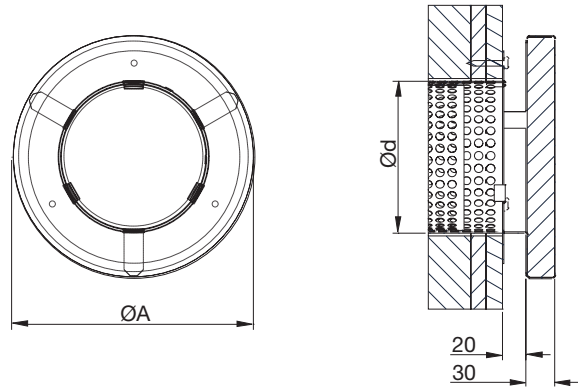

Size	ØA mm	Ød mm
100	160	100
125	200	125
160	250	160

Hole dimension =  $\text{Ød} + 10 \text{ mm}$

## Order code

<b>Product</b>	<b>OLC</b>	<b>aaa</b>	<b>A</b>
Type			
Size			
Version			

## Materials and finish

Installation bracket:	Galvanised steel
Front plate:	Galvanised steel
Standard finish:	Powder-coated
Standard colour:	RAL 9010, Gloss 30

The diffuser is available in other colours. Please contact Lindab's sales department for further information.



# Pressure control valve

OLC

## Technical data

### Sample calculation

When dimensioning an overflow diffuser, calculate the decrease in the wall's noise-reducing properties. For these calculations, the area of the wall and sound reduction figure R must be known. This is adjusted in relation to the diffuser's  $D_{n,e}$  value.  $D_{n,e}$  is the diffuser's R value given at a transmission area of 10 m<sup>2</sup>, as specified in ISO 140-10. The  $D_{n,e}$  value can be converted into the R value for other transmission areas using the table below.

area [m <sup>2</sup> ]	10	2	1
correction [dB]	0	-7	-10

The diagram below indicates the decrease in the wall's reduction figure, based on the diffuser, in a given octave band:

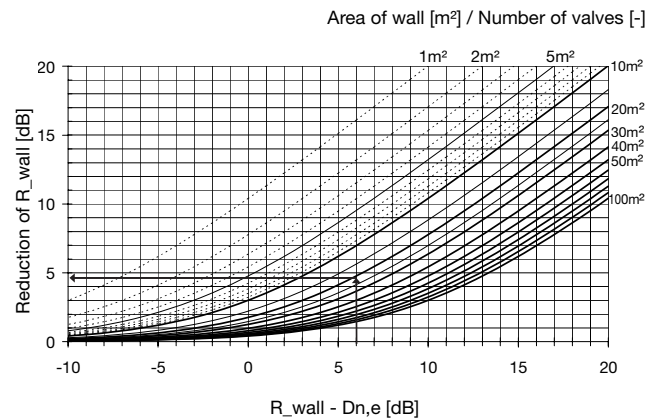

As a rough estimate the calculation can be performed directly using the wall's  $R_w$  value.

Example:  
 $R_w$  (wall) 50 dB  
 $D_{n,e,w}$  (diffuser) 44 dB       $R_w - D_{n,e,w} = 6$  dB  
 Area of wall 20 m<sup>2</sup>  
 Number of diffusers 1       $20 \text{ m}^2 / 1 = 20 \text{ m}^2$

Indicated reduction of  $R_w$  (wall): 5  
 $R_w$  value for wall with diffuser  $\sim 50 - 5 = 45$  dB

The calculation can also be performed using the following formula:

$$R_{res} = 10 \cdot \text{Log} \left( \frac{S}{(10 \text{ m}^2 \cdot 10^{-0,1 \cdot D_{n,e}}) + (S \cdot 10^{-0,1 \cdot R_{wall}})} \right)$$

where:

- $R_{res}$  is the resulting reduction figure for wall and diffuser.
- S is wall area.
- $D_{n,e}$  is the diffuser's  $D_{n,e}$  value.
- $R_{wall}$  is the wall's R value without diffuser.

## Technical data

### Capacity

Volume flow  $q$  [l/s] and [m<sup>3</sup>/h], total pressure drop  $p_t$  [Pa] and sound effect level  $L_{WA}$  [dB(A)] are specified for a diffuser on either side of the wall.

### Dimensioning diagram

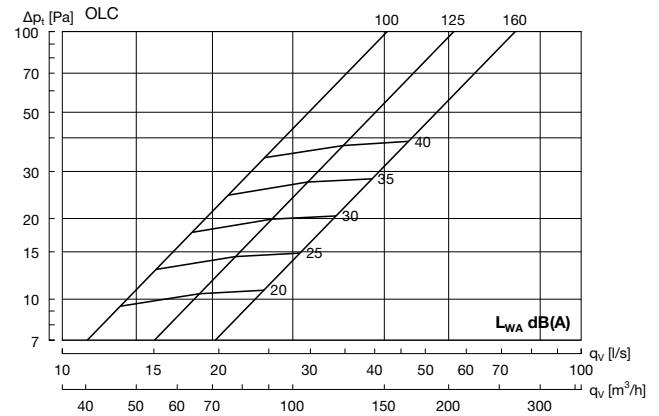

### Element-normalised reduction figure $D_{n,e}$

Table 1: Cavity wall with 120 mm insulation

Size	Centre frequency Hz					$D_{n,e,w}$
	125	250	500	1K	2K	
100	*29	*35	40	*44	*50	44
125	*29	*35	40	*43	*52	44
160	*29	*35	38	43	52	43

Table 2: Cavity wall with 35-70 mm insulation

Size	Centre frequency Hz					$D_{n,e,w}$
	125	250	500	1K	2K	
100	*29	*35	40	*40	*51	43
125	*29	*35	37	*40	*50	42
160	*29	*35	35	40	49	41

Table 3: Solid wall without insulation

Size	Centre frequency Hz					$D_{n,e,w}$
	125	250	500	1K	2K	
100	*29	*35	30	35	46	36
125	*29	*35	30	36	45	36
160	*29	*35	28	38	45	36

\* minimum values

# Pressure control valve

# OLR



## Description

OLR is a rectangular pressure control valve for installation directly onto a wall. OLR consists of two sound-attenuating baffles, which are mounted either side of the wall and connected by means of the accompanying perforated wall sleeve, which ensures excellent noise reduction.

- High capacity
- Sound-attenuating baffles
- Can be installed in wall thicknesses from 90-170 mm

## Maintenance

Front plate can be removed to enable cleaning of internal parts. The visible parts of the diffuser can be wiped with a damp cloth.

## Order code

<b>Product</b>	<b>OLR</b>	<b>aaa</b>	<b>A</b>
Type			
Size			
Version			

## Dimensions

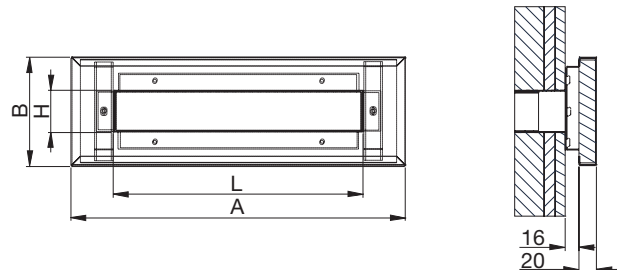

Size	A mm	B mm	L mm	H mm
400	400	130	300	50
600	600	130	500	50
800	800	130	700	50
1000	1000	130	900	50

Hole dimension = L + 5 mm x H + 5 mm

## Materials and finish

Installation bracket:	Galvanised steel
Front plate:	Galvanised steel
Standard finish:	Powder-coated
Standard colour:	RAL 9010, Gloss 30

The diffuser is available in other colours. Please contact Lindab's sales department for further information.

- 1
- 2
- 3
- 4
- 5
- 6
- 7
- 8
- 9
- 10
- 11
- 12
- 13
- 14
- 15
- 16
- 17
- 18

# Pressure control valve

OLR

## Technical data

### Sample calculation

When dimensioning an overflow diffuser, calculate the decrease in the wall's noise-reducing properties. For these calculations, the area of the wall and sound reduction figure R must be known. This is adjusted in relation to the diffuser's  $D_{n,e}$  value.  $D_{n,e}$  is the diffuser's R value given at a transmission area of 10 m<sup>2</sup>, as specified in ISO 140-10. The  $D_{n,e}$  value can be converted into the R value for other transmission areas using the table below.

area [m <sup>2</sup> ]	10	2	1
correction [dB]	0	-7	-10

The diagram below indicates the decrease in the wall's reduction figure, based on the diffuser, in a given octave band:

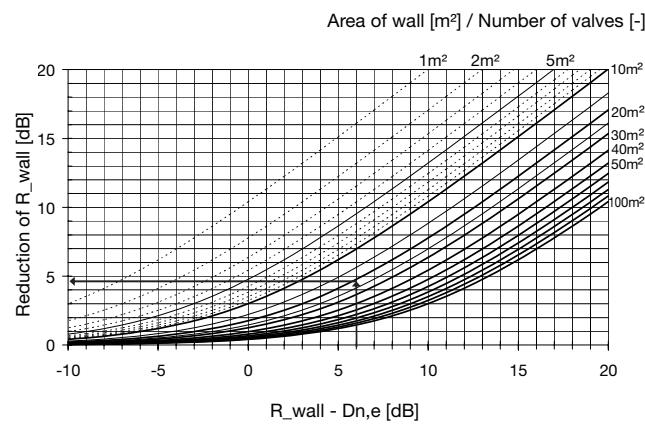

As a rough estimate the calculation can be performed directly using the wall's  $R_w$  value.

Example:  
 $R_w$  (wall) 50 dB  
 $D_{n,e,w}$  (diffuser) 44 dB       $R_w - D_{n,e,w} = 6$  dB  
 Area of wall 20 m<sup>2</sup>  
 Number of diffusers 1       $20 \text{ m}^2 / 1 = 20 \text{ m}^2$

Indicated reduction of  $R_w$  (wall): 5  
 $R_w$  value for wall with diffuser  $\sim 50 - 5 = 45$  dB

The calculation can also be performed using the following formula:

$$R_{res} = 10 \cdot \text{Log} \left( \frac{S}{(10 \text{ m}^2 \cdot 10^{-0,1 \cdot D_{n,e}}) + (S \cdot 10^{-0,1 \cdot R_{wall}})} \right)$$

where:

- $R_{res}$  is the resulting reduction figure for wall and diffuser.
- S is wall area.
- $D_{n,e}$  is the diffuser's  $D_{n,e}$  value.
- $R_{wall}$  is the wall's R value without diffuser.

## Technical data

### Capacity

Volume flow  $q$  [l/s] and [m<sup>3</sup>/h], total pressure drop  $p_t$  [Pa] and sound effect level  $L_{WA}$  [dB(A)] are specified for a diffuser on either side of the wall.

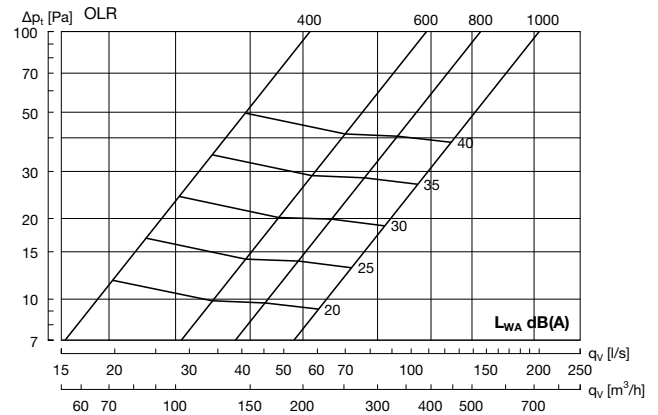

### Element-normalised reduction figure $D_{n,e}$

Table 1: Cavity wall with 120 mm insulation

Size	Centre frequency Hz					$D_{n,e,w}$
	125	250	500	1K	2K	
400	*31	37	41	46	55	46
600	*29	35	38	43	52	43
800	*28	34	37	42	51	42
1000	*26	33	36	41	50	41

Table 2: Cavity wall with 35-70 mm insulation

Size	Centre frequency Hz					$D_{n,e,w}$
	125	250	500	1K	2K	
400	*31	37	39	42	52	44
600	*29	35	37	40	49	42
800	*28	34	35	39	48	40
1000	*26	33	34	38	47	39

Table 3: Positioning over a frame in a cavity wall with 70 mm insulation

Size	Centre frequency Hz					$D_{n,e,w}$
	125	250	500	1K	2K	
400	*31	37	36	41	52	42
600	*29	35	33	39	49	39
800	*28	34	32	38	48	38
1000	*26	33	31	37	47	37

Table 4: Solid wall without insulation

Size	Centre frequency Hz					$D_{n,e,w}$
	125	250	500	1K	2K	
400	*31	37	32	37	45	38
600	*29	35	30	35	43	36
800	*28	34	28	33	42	34
1000	*26	33	27	32	41	33

\* minimum values