

LATERAL SOUND FLANKING TRANSMISSION AT CURTAIN WALL MULLIONS:
AN EMPIRICAL INVESTIGATION TO IDENTIFY CONTROLLING MECHANISMS

By

Elizabeth Valmont

Bachelor of Architecture

Master of Building Science

University of Southern California



A Dissertation Proposal Presented to the

FACULTY OF THE USC GRADUATE SCHOOL

In Partial Fulfillment of the Requirements for the Degree
DOCTOR OF PHILOSOPHY IN ARCHITECTURE

August 2015

Copyright 2015

Elizabeth Valmont

ACKNOWLEDGMENTS

The dissertation has brought about great learning and life challenges. Those who have been part of this journey have contributed to my life in ways that are beyond the expression of these acknowledgements.

I would like to firstly thank my dissertation committee who have steered my work to completion. Most especially Professor Douglas Noble, the committee chair, for his mentoring, guidance and persistent encouragement to achieve my best. Professor Marc Schiler, one my first mentors in the building sciences, academic teaching and profound thinking, always supported the direction of my work. Jerry Christoff, my first acoustic mentor, always advocated for me to pursue the PhD and this topic, and made time to see me succeed to the end. Professor James Moore provided mentoring to help me delineate the big picture of the research study and clarify.

Additionally I especially thank those at Enclos and WEAL who contributed to the research project. Mic Patterson kick started the process with his motivation and belief in me, and presented TJ Deganyar at Enclos. TJ Deganyar was responsible for realizing the laboratory test circuits and was also very passionate about this research, providing both supportive time and funding. Gary Mange, the former lab director at WEAL, provided technical counsel and research support during all the test phases. Raul Martinez, the laboratory technician at WEAL, labored with me and provided innovative ways to rig the full scale building test specimens.

Hooshang Khosrovani, from Veneklasen, provided considerable time and great mentorship and advice to help me think critically about the research structure and questions. My great appreciation goes to Karen Kensek who thoughtfully reviewed and critically edited the dissertation. Adam Foxwell from Arup took the time to review my work and gave me great inspiration. Rachid Abu Hassan, also from Arup, helpfully reviewed the initial idea with me.

The many laboratory measurements, documentation, photography, equipment, and moral support would not have been possible without the assistance of my fellow colleagues and friends. I owe an enormous thank you to the MBS and PhD colleagues (Eve Shih-Hsin Lin, Jae Yong Suk, Yara Masri, Andrea Martinez-Arias, and Ed Losch), Enclos colleagues (James Casper and Daniel Bettenhausen), and Veneklasen colleagues. I particularly appreciate Eve, generous with her knowledge and time. Rick Lasser from Arup helped with photography and Patrick Masson was the first to help me on the first day of testing.

I appreciate all financial grants, funding and awards from Enclos Corp, WEAL, Thornton Thomasetti, Arup, Newman Medal, and the Architectural Research Centers Consortium.

I would also like to acknowledge the Ph.D. program and the Chase L. Leavitt Graduate Building Science program at the University of Southern California. They provided a great scholarly community of professors and students conducting inspiring and outstanding research. I am honored to contribute to the seminal research of the Ph.D. program in Architecture at the University. Professor Douglas Noble is responsible for pioneering this unique program that targets the advancement of multidisciplinary research in façade tectonics and without whom I would have never entered this program.

Most importantly, I thank my parents and family. Their love and support helped me to persevere and strengthen my awareness.

TABLE OF CONTENTS

ACKNOWLEDGMENTS	2
LIST OF TABLES	8
LIST OF FIGURES	10
ABSTRACT	16
TERMS & ABBREVIATIONS	18
ACOUSTIC TERMS/TEST.....	18
ACOUSTIC ABBREVIATIONS	18
CHAPTER 1 INTRODUCTION TO CURTAIN WALL SOUND FLANKING TRANSMISSION	20
1.1 ACOUSTIC RELEVANCE TO GLASS CURTAIN WALL DESIGN	20
1.2 PROBLEM STATEMENT AND HYPOTHESIS	23
1.2.1 Building Sound Flanking Paths.....	25
1.2.2 Composite Transmission Loss.....	26
1.3 OVERVIEW OF RESEARCH.....	27
1.3.1 Research Objectives.....	28
1.3.2 Research Method.....	28
1.3.3 Approach to Measuring the Test Specimens	29
1.4 DISSERTATION OUTLINE	30
CHAPTER 2 FAÇADE BACKGROUND REVIEW AND PROFESSIONAL APPLICATIONS IN ACOUSTICS	32
2.1 ACOUSTIC DETAILING AT CURTAIN WALL MULLIONS	32
2.1.1 The Anatomy of the Glass Curtain Wall.....	32
2.1.2 Multidisciplinary Design Provisions.....	39
2.1.3 Acoustic Detail Considerations.....	41
2.2 ACOUSTIC MITIGATION PRACTICES AND PRODUCTS FOR MULLIONS	42
2.2.1 Practice-Based Mullion Modifications	42
2.2.2 Product-Based Mullion Modification	45
2.2.3 Summary of Practice and Product Solutions.....	48
2.3 SOUND ISOLATION METRICS AND MEASUREMENT METHODS	49
2.3.1 ASTM Standard Test Methods and Rating Procedures	49
2.3.2 ISO Standard Test Methods and Rating Procedures	52

2.3.3 Sound Isolation Criteria	55
2.4 ACOUSTIC PRECEDENT RESEARCH STUDIES.....	58
2.4.1 Laboratory Entities and Investigations of Façade Sound Isolation	58
2.4.2 Sound Flanking Prediction Methods	60
2.4.3 Precedent Acoustic Test Measurements of Curtain Wall Elements	61
2.5 SUMMARY OF PROFESSIONAL BACKGROUND AND PRECEDENT RESEARCH	66
CHAPTER 3 UNITIZED VERTICAL MULLION RESEARCH METHODOLOGY	67
3.1 INTRODUCTION	67
3.2 REVIEW OF ACOUSTIC PRACTICES AND PROCEDURES AT CURTAIN WALL FACADES.....	68
3.3 LABORATORY TEST PROCEDURE.....	68
3.3.1 Test Constants and Variables.....	70
3.3.2 Curtain Wall System Specimen.....	70
3.3.3 Test Specimen Components	73
3.3.4 Laboratory Test Chambers	75
3.3.5 Test Experiment Factors	82
3.4 LABORATORY RESULT ANALYSIS.....	82
3.4.1 Sound Transmission Correlations and Comparisons	82
3.4.2 Composite Transmission Loss Predictions.....	82
CHAPTER 4 TEST RESULTS AND ANALYSIS OF THE UNITIZED VERTICAL MULLION MEASUREMENT PHASES	84
4.1 INTRODUCTION	84
4.2 PHASE 1 – MULLION ELEMENT (ISOLATED)	85
4.2.1 Phase 1 Specimen and Test Chamber Description.....	85
4.2.2 Testing Classifications	88
4.2.3 Material descriptions.....	89
4.2.4 Phase 1 Class A Test Sequence	91
4.2.5 Phase 1 Class B Test Sequence	93
4.2.7 Phase 1 Class C1 Test Sequence	98
4.2.8 Phase 1 Class C2 Test Sequence	101
4.2.9 Phase 1 Class C3 Test Sequence	104
4.2.10 Phase 1 Class C4 Test Sequence	106
4.2.11 Phase 1 Summary	110
4.3 PHASE 2A – COMPOSITE SEAL AND CONNECTION ELEMENTS (WITH MULLION)	113
4.3.1 Phase 2A Test Specimen Description	114
4.3.2 Phase 2A Testing Classifications	116
4.3.3 Phase 2A Class A Test Sequence	119

4.3.4 Phase 2A Class B Test Sequence.....	121
4.3.5 Phase 2A Class C Test Sequence.....	124
4.3.6 Phase 2A Class D Test Sequence	128
4.3.7 Phase 2A Class E Test Sequence	131
4.3.8 Phase 2A Conclusion.....	132
4.4 PHASE 2B –CONNECTION ELEMENT (WITHOUT MULLION).....	136
4.4.1 Phase 2B Test Specimen Description.....	138
4.4.3 Phase 2B Testing Classifications	141
4.4.4 Phase 2B Class A Test Sequence.....	143
4.4.5 Phase 2B Class B Test Sequence.....	151
4.4.6 Phase 2B Class C Test Sequence.....	156
4.4.7 Phase 2B Observations and Conclusion	160
4.5 PHASE 3 – GLAZING ASSEMBLY ELEMENT	161
4.5.1 Phase 3 Test Specimen Description.....	162
4.5.2 Phase 3 Test Chamber Construction	163
4.5.3 Phase 3 Test Sequence	167
4.5.4 Phase 3 Summary	168
4.6 UVM MEASUREMENT SUMMARY	169
CHAPTER 5 ANALYSIS OF CONTROLLING MECHANISMS AND COMPOSITE TRANSMISSION LOSS	171
5.1 INTRODUCTION	171
5.2 CONNECTED VERSUS UNCONNECTED MULLION CONDITIONS.....	171
5.2.1 Comparison: Single Figure Rating	172
5.2.2 Noise Reduction Comparison: Phase 1 and Phase 3.....	174
5.2.3 Mechanisms Limiting Sound Isolation Performance	181
5.3 COMPOSITE TRANSMISSION LOSS PREDICTIONS.....	186
5.3.1 Calculation Variables and Descriptions	186
5.3.2 Composite TL with Low Performing UVM Elements (without glass)	189
5.3.3 Composite TL with Low Performing UVM Elements (with glass).....	191
5.3.4 Composite TL with High Performing UVM Elements (without glass)	192
5.3.5 Composite TL with High Performing UVM Elements (with glass).....	193
5.3.6 Summary of Composite TL Analysis	194
5.4 RANKING RELATIVE PERFORMANCE.....	196
5.5 ANALYSIS SUMMARY.....	199
CHAPTER 6 CONCLUSION	200
6.1 INTRODUCTION	200

6.2 PRACTICES AND PROCEDURES	201
6.3 TEST METHODOLOGY FOR UNITIZED MULLIONS	202
6.4 CONTROLLING ELEMENTS AT THE UNITIZED VERTICAL MULLION	204
6.4.1 <i>Improvements at the Unconnected Unitized Mullion</i>	206
6.4.2 <i>Improvements at the Connected Unitized Mullion</i>	207
6.5 COMPOSITE TRANSMISSION LOSS PERFORMANCE	207
6.6 LIMITATIONS.....	208
CHAPTER 7 FUTURE WORK	209
7.1 FUTURE TESTING AND DESIGN INVESTIGATIONS.....	209
7.1.1 <i>Future Laboratory Tests Measurements</i>	209
7.1.2 <i>Future Curtain Wall Design Concept Studies</i>	210
7.1.3 <i>Future Research Analytical Studies</i>	210
7.2 CONCLUSION	211
BIBLIOGRAPHY	212
APPENDIX A TERMINOLOGY	217
A.1 LABORATORY TEST STANDARDS.....	217
A.2 ACOUSTIC AND ARCHITECTURAL TERMS	218
APPENDIX B UVM LABORATORY TEST RESULTS	229
B.1 INTRODUCTION	229
B.1.1 <i>Test Measurement Standards</i>	229
B.2 PHASE 1 WEAL TEST RESULTS.....	230
B.3 PHASE 2A WEAL TEST RESULTS	252
B.4 PHASE 2B WEAL TEST RESULTS.....	276
B.5 PHASE 3 WEAL TEST RESULTS.....	307
APPENDIX C ANCILLARY SOUND ANALYSIS	313
C.1 INTRODUCTION	313
C.2 PHASE 1 MULLION CONTROLS	314
C.3 UVM TEST ELEMENT COMPARISON WITH A 4" AIRSPACE.....	315
C.4 UVM TEST ELEMENT COMPARISON WITH A 3" AIRSPACE.....	316
C.5 UVM TEST ELEMENT COMPARISON WITH A 3" AIRSPACE, BATT INFILL	317
C.6 UVM TEST ELEMENT COMPARISON WITH A 3" AIRSPACE, GYPSUM OVERCLAD.....	318
C.7 PHASE 2B CLASS A SUMMARY GRAPHS	319

C.8 PHASE 2B PARALLEL PLATE WITH VARIED AIR SPACE	320
C.9 COMPARISONS BETWEEN PHASE 1 AND PHASE 3	321
C.10 UNCONNECTED AND CONNECTED (HOLLOW AND FILLED)	324
APPENDIX D ANCILLARY VIBRATION ANALYSIS	326
D.1 INTRODUCTION	326
D.2 VIBRATION MEASUREMENT SET UP	327
<i>D.2.1 Measurement and Chamber Set Up</i>	327
<i>D.2.2 Equipment and Procedure</i>	329
D.3 VIBRATION MEASUREMENT RESULTS	330
<i>D.3.1 [A_v] Vibration Measurement Results</i>	331
<i>D.3.2 [B_v] Vibration Measurement Results</i>	332
<i>D.3.3 [C_v] Vibration Measurement Results</i>	333
<i>D.3.4 [D_v] Ph3 - Vibration Measurement Results</i>	334
D.4 VIBRATION ANALYSIS.....	335
<i>D.4.1 Measurement EV1 [A_v] and EV2 [B_v].</i>	335
<i>D.4.2 Calculation Procedure</i>	336
<i>D.4.2.1 Acceleration Level (dB) to Acceleration (m/s²)</i>	338
<i>D.4.3 Graphed Results of Conversions</i>	339
<i>D.4.4 Analysis Summary</i>	342
D.5 VIBRATION MEASUREMENT SUMMARY	343

LIST OF TABLES

TABLE 1-1:	DISSERTATION OUTLINE.....	31
TABLE 2-1:	MULLION PRODUCTS TO REDUCE SOUND FLANKING TRANSMISSION AT THE CURTAIN WALL	47
TABLE 2-2:	CORRELATION BETWEEN ASTM AND ISO SOUND ISOLATION INDICES	52
TABLE 2-3:	INTERNATIONAL STANDARDS FOR SOUND ISOLATION AND FLANKING TRANSMISSION	54
TABLE 2-4:	AMERICAN STANDARDS FOR SOUND ISOLATION AND FLANKING TRANSMISSION	54
TABLE 2-5:	APPROXIMATE COMPARISON OF SOUND ISOLATION CRITERIA FOR INTERNATIONAL RESIDENTIAL BUILDING CODE, STC.....	55
TABLE 3-1:	OVERVIEW OF APPROACH TO RESEARCH STUDY	67
TABLE 3-2:	UVM METHOD DESCRIPTION	69
TABLE 3-3:	FILLER WALL TESTS, PERFORMANCES AND DESCRIPTION S	77
TABLE 4-1:	TEST PHASE OUTLINE OF DATE, UVM, AND RESULTS	84
TABLE 4-2:	PHASE 1 CLASS A, STC RESULTS, AND SPECIMEN DESCRIPTION	91
TABLE 4-3:	PHASE 1 CLASS B, STC RESULTS, AND SPECIMEN DESCRIPTION	93
TABLE 4-4:	CLASS B STANDARD DEVIATION	96
TABLE 4-5:	PHASE 1 CLASS C1, STC TEST RESULTS AND SPECIMEN DESCRIPTION.....	98
TABLE 4-6:	CLASS C1 STANDARD DEVIATION	100
TABLE 4-7:	PHASE 1 CLASS C2, STC TEST RESULTS AND SPECIMEN DESCRIPTION.....	101
TABLE 4-8:	CLASS C2 STANDARD DEVIATION	102
TABLE 4-9:	PHASE 1 CLASS C3, STC TEST RESULTS, AND SPECIMEN DESCRIPTION	104
TABLE 4-10:	CLASS C3 STANDARD DEVIATION	105
TABLE 4-11:	PHASE 1 CLASS C4, STC TEST RESULTS AND SPECIMEN DESCRIPTION.....	106
TABLE 4-12:	CLASS C4 STANDARD DEVIATION	108
TABLE 4-13:	STANDARD DEVIATION BETWEEN ALL PHASE 1 TEST SPECIMENS	111
TABLE 4-14:	PHASE 1 COMPARISONS WITH MC-1 (TL13-311)	112
TABLE 4-15:	PHASE 2A CLASS A TEST CONFIGURATION DESCRIPTION, PLAN DRAWING	116
TABLE 4-16:	PHASE 2A CLASS B TEST CONFIGURATION DESCRIPTION, PLAN DRAWING	116
TABLE 4-17:	PHASE 2A CLASS C TEST CONFIGURATION DESCRIPTION, PLAN DRAWING	117
TABLE 4-18:	PHASE 2A CLASS D TEST CONFIGURATION DESCRIPTION, PLAN DRAWING.....	117
TABLE 4-19:	PHASE 2A CLASS E TEST CONFIGURATION DESCRIPTION, PLAN DRAWING	118
TABLE 4-20:	PHASE 2A CLASS A, STC RESULTS AND SPECIMEN DESCRIPTION.....	119
TABLE 4-21:	PHASE 2A CLASS B, STC RESULTS AND SPECIMEN DESCRIPTION.....	122
TABLE 4-22:	PHASE 2A CLASS C, STC RESULTS AND SPECIMEN DESCRIPTION.....	125
TABLE 4-23:	PHASE 2A CLASS D, STC RESULTS AND SPECIMEN DESCRIPTION	129
TABLE 4-24:	PHASE 2A CLASS E, STC RESULTS, AND SPECIMEN DESCRIPTION	131
TABLE 4-25:	RESULT SUMMARY OF STC RANGE FOR SMALL AND LARGE VEC	133
TABLE 4-26:	PHASE 2B CLASS A SOLID PLATE DESCRIPTION AND PLAN DRAWING.....	141

TABLE 4-27:	PHASE 2B CLASS A STAGGERED PLATE DESCRIPTION AND PLAN DRAWING	141
TABLE 4-28:	PHASE 2B CLASS C PRODUCT TEST DESCRIPTION AND PLAN DRAWING	142
TABLE 4-29:	PHASE 2B CLASS A, STC TEST RESULTS, AND SPECIMEN DESCRIPTION	145
TABLE 4-30:	PHASE 2B CLASS B, STC TEST RESULTS AND SPECIMEN DESCRIPTION	153
TABLE 4-31:	PHASE 2B CLASS C, STC TEST RESULTS AND SPECIMEN DESCRIPTION	156
TABLE 4-32:	PHASE 3 STC TEST RESULTS	167
TABLE 5-1:	STC AND NR RATING COMPARISON OF SELECT MULLION TESTS FROM PHASE 1 AND PHASE 3 ...	172
TABLE 5-2:	OBSERVATIONS OF THREE COMPARABLE TEST SPECIMENS FROM PHASE 1 AND PHASE 3	174
TABLE 5-3:	TL13-316 AND TL14-168	183
TABLE 5-4:	SUMMARY OF STC EXTRAPOLATION BETWEEN UNCONNECTED AND CONNECTED MULLIONS....	184
TABLE 5-5:	SUMMARY OF PREDICTED COMPOSITE TRANSMISSION LOSS	194
TABLE 5-6:	SUMMARY OF PREDICTED COMPOSITE TRANSMISSION LOSS	194
TABLE 6-1:	RELATIVE STC IMPROVEMENTS FOR VARIOUS MULLION RETROFIT OPTIONS	206
TABLE 6-2:	RELATIVE STC IMPROVEMENTS FOR VARIOUS MULLION RETROFIT OPTIONS	207
TABLE 6-3:	SUMMARY OF PREDICTED COMPOSITE TL PERFORMANCES	207
TABLE 7-1:	FUTURE WORK	209
TABLE A- 1:	DECIBELS	221
TABLE A- 2:	PHYSICAL DESCRIPTIONS AND AUDITIVE PERCEPTION	224
TABLE A- 3:	SUBJECTIVE EFFECT OF CHANGES IN SOUND PRESSURE LEVEL.....	224
TABLE D- 1:	PHASE 3 CONFIGURATION OF VIBRATION MEASUREMENT	327
TABLE D- 2:	PHASE 3 CONFIGURATION OF VIBRATION MEASUREMENT	329
TABLE D- 3:	VIBRATION MEASUREMENT EQUIPMENT	329
TABLE D- 4:	[A _v] SOURCE AND RECEIVER RESULTS, 5 SEC DB L,LEQ.....	331
TABLE D- 5:	[B _v] SOURCE AND RECEIVER RESULTS, 5 SEC DB L,LEQ	332
TABLE D- 6:	[C _v] SOURCE AND RECEIVER RESULTS, 5 SEC DB L,LEQ	333
TABLE D- 7:	[D _v] SOURCE AND RECEIVER RESULTS, 5 SEC DB L,LEQ.....	334
TABLE D- 8:	SELECTED VIBRATION MEASUREMENTS FROM TEST EV1 AND EV2.....	335
TABLE D- 9:	SELECTED VIBRATION MEASUREMENTS FROM TEST EV1 AND EV2	342

LIST OF FIGURES

FIGURE 1-1:	DIAGRAM OF SOUND TRANSMISSION PATHS AT THE CURTAIN WALL FACADE	20
FIGURE 1-2:	DESIGN CONSIDERATIONS REQUIRED AT THE CURTAIN WALL SYSTEM INCLUDING ACOUSTICS....	21
FIGURE 1-3:	L.A. LIVE TOWER AND RESIDENCES, LOS ANGELES, CA	22
FIGURE 1-4:	PLAN DIAGRAM, LATERAL SOUND FLANKING PATH AT THE INTERFACE BETWEEN A CURTAIN WALL SYSTEM AND INTERIOR DEMISING PARTITION	23
FIGURE 1-5:	PLAN DIAGRAM OF A UNITIZED MULLION SYSTEM CONNECTED TO AN INTERIOR WALL PARTITION; THREE SOUND PATHS IDENTIFIED.	24
FIGURE 1-6:	DIAGRAM SHOWING FOUR JUNCTIONS AT A DEMISING WALL	25
FIGURE 1-7:	DIAGRAM OF RESEARCH DESIGN	27
FIGURE 1-8:	PLAN DIAGRAM OF THE EXPERIMENT TEST PHASES DEFINED BY THREE CURTAIN WALL SPECIMENS.....	29
FIGURE 2-1:	SOUND TRANSMISSION PATHS ALONG A CURTAIN WALL FACADE.....	33
FIGURE 2-2:	UNITIZED VERTICAL MULLION EXTRUSION DISASSEMBLED FROM THE GLASS INFILL: THE CONNECTED MULLION (A) AND UNCONNECTED MULLION (D).....	34
FIGURE 2-3:	SECTION OF PLASTIC MULLION MOCKUP WITH ANTI-BUCKLING CLIPS-	34
FIGURE 2-4:	PLAN DIAGRAM OF FIVE INDICATIVE SOUND PATHS AT THE GLASS CURTAIN WALL.....	36
FIGURE 2-5:	INDICATIVE DIAGRAMS SHOWING THE COMPOSITE PERFORMANCE BETWEEN A HIGH STC WALL RATING AND LOW STC RATING OF A MULLION.	37
FIGURE 2-6:	SECTION THROUGH A CURTAIN WALL TRANSOM WHERE IT IS CONNECTED AT THE STRUCTURAL SLAB.....	39
FIGURE 2-7:	CATEGORIES OF MULLION DETAIL MODIFICATIONS CONSIDERED TO IMPROVE SOUND ISOLATION .	42
FIGURE 2-8:	STC REFERENCE CONTOUR AGAINST THE TRANSMISSION LOSS OF A TESTED SPECIMEN	50
FIGURE 2-9:	DEFINITION OF SOUND TRANSMISSION PATHS BETWEEN ROOMS PER ISO 12354	54
FIGURE 2-10:	PLAN DRAWING OF “SPLIT” MULLION (LEFT) AND DNF PERFORMANCE (RIGHT)	61
FIGURE 2-11:	SIMULATED FLOOR SLAB CONDITION AND TEST CHAMBER CONFIGURATION (LEFT) AND PHYSICAL TEST SETUP (RIGHT)	63
FIGURE 2-12:	TEST SPECIMEN OF AN OVERCLAD MULLION ELEMENT AND LOCATION IN THE FILLER WALL APERTURE	64
FIGURE 2-13:	TL OF THE MODIFIED MULLIONS	64
FIGURE 3-1:	PLAN DIAGRAM OF BUILDING ELEMENTS AND TEST PHASES ASSOCIATED WITH THE CURTAIN WALL ASSEMBLY	69
FIGURE 3-2:	UNITIZED CURTAIN WALL SYSTEM SHOP DRAWINGS, PLAN AND ELEVATION.....	71
FIGURE 3-3:	UNITIZED CURTAIN WALL SYSTEM SHOP DRAWINGS, DETAIL AT THE JOINT	72
FIGURE 3-4:	PLAN DIAGRAM OF THE MULLION USED IN PHASE 1.....	73
FIGURE 3-5:	PLAN DIAGRAM OF A CONCEPT CONNECTION USED PHASE 2.....	73
FIGURE 3-6:	PLAN DIAGRAM OF GLASS CURTAIN WALL USED IN PHASE 3.....	73
FIGURE 3-7:	BASIC SETUP OF THE TEST SPECIMEN LOCATED IN THE TEST CHAMBER FILLER WALL.	73

FIGURE 3-8: DIAGRAM PLAN DRAWINGS OF THE TRANSMISSION LOSS CHAMBER AT WEAL AND THE TEST ELEMENTS FROM THE CURTAIN WALL SYSTEM.....	75
FIGURE 3-9: CHAMBER FILLER WALL CONSTRUCTION (DETAIL COURTESY OF WEAL)	76
FIGURE 3-10: APERTURE IN CHAMBER FILLER WALL IS OPEN WITHOUT A TEST SPECIMEN	77
FIGURE 3-11: APERTURE IN CHAMBER FILLER WALL IS FILLED WITH A TEST SPECIMEN (SPECIFICALLY FILLED WITH A MULLION AND SILICONE CONNECTION USED IN PHASE 2A)	77
FIGURE 3-12: SOUND TRANSMISSION PLOTS OF FILLER WALL.....	78
FIGURE 3-13: PLAN DRAWING OF AUXILIARY SEMI-ANECHOIC CHAMBERS 3S AND 3R CUSTOM BUILT FOR THE PHASE 3 TEST MEASUREMENTS	79
FIGURE 3-14: INTERSECTION DETAIL AT THE WEAL FILLER WALL AND THE CURTAIN WALL BAY	80
FIGURE 3-15: SEMI-ANECHOIC CHAMBER 3S AT THE SOURCE SIDE FILLED WITH BATT INSULATION.....	80
FIGURE 3-16: SEMI-ANECHOIC CHAMBER 3S AT THE SOURCE SIDE.....	81
FIGURE 3-17: SEMI-ANECHOIC CHAMBER 3R AT THE SOURCE SIDE	81
FIGURE 4-1: PHASE 1: PLAN DIAGRAM OF UVM ELEMENTS AND ASSOCIATED TEST PHASES	85
FIGURE 4-2: PLAN DRAWING OF UNITIZED VERTICAL MULLION PROFILE	86
FIGURE 4-3: IMAGE OF HOLLOW EXPOSED MULLION PROFILE WITH ANTI-BUCKLING CLIPS, WOOD SPACES AND SILICONE GASKET	86
FIGURE 4-4: IMAGE OF HOLLOW EXPOSED MULLION PROFILE WITH ANTI-BUCKLING CLIPS, WOOD SPACES AND SILICONE GASKET	87
FIGURE 4-5: A ¼" GAP BETWEEN MULLION PERIMETER AND FILLER WALL.....	87
FIGURE 4-6: PUTTY APPLIED TO SPECIMEN PERIMETER EDGE TO SEAL ACOUSTIC LEAKS	87
FIGURE 4-7: ELEVATION OF THE MULLION IN THE FILLER WALL WITH SEALED PUTTY PERIMETER	88
FIGURE 4-8: CLASS A – MULLION (HOLLOW AND EXPOSED)	90
FIGURE 4-9: CLASS B – FILLED MULLIONS	90
FIGURE 4-10: CLASS C – OVERCLAD MULLIONS	90
FIGURE 4-11: PHASE 1-A TRANSMISSION LOSS CURVES	92
FIGURE 4-12: CLASS B FILLED MULLION (A) PEA GRAVEL (B) SAND (C) MINERAL WOOL (D) MLV PILLOWS	94
FIGURE 4-13: PHASE 1-B TRANSMISSION LOSS CURVES	95
FIGURE 4-14: CLASS C OVERCLAD MULLION IMAGES FROM TEST SERIES C1, C2, C3, AND C4	97
FIGURE 4-15: PHASE 1-B TRANSMISSION LOSS CURVES	99
FIGURE 4-16: PHASE 1-C2 TRANSMISSION LOSS CURVES	102
FIGURE 4-17: PHASE 1-C3 TRANSMISSION LOSS CURVES	105
FIGURE 4-18: PHASE 1-C4 TRANSMISSION LOSS	107
FIGURE 4-19: TRANSMISSION LOSS OVERLAY OF PHASE 1-C4 AND PAC INTERNATIONAL® RSIC SPECIMEN ...	108
FIGURE 4-20: WEAL TL13-329 STC 48, LAB FILLER WALL STC 74 FILLER WALL	108
FIGURE 4-21: RAL TL05-167, STC 58, COMPOSITE WALL PARTITION STC 64 © PAC INTERNATIONAL®	108
FIGURE 4-22: TRANSMISSION LOSS SPECTRA OF ALL PHASE 1 E90 LABORATORY TESTS	110
FIGURE 4-23: MULLION CONSTANT 1 (MC1) SHOWN IN PLAN (LEFT) AND SPECIMEN PHOTO (RIGHT)	111
FIGURE 4-24: MULLION CONSTANT 2 (MC2) SHOWN IN PLAN (LEFT) AND SPECIMEN PHOTO (RIGHT)	111
FIGURE 4-25: PHASE 2A: PLAN DIAGRAM OF UVM ELEMENTS AND ASSOCIATED TEST PHASES.....	113

FIGURE 4-26: HEAD OF NARROW APERTURE WIDTH OF 7-3/4"	114
FIGURE 4-27: HEAD OF WIDE APERTURE WIDTH OF 8-1/4"	114
FIGURE 4-28: IMAGE OF THE PCS-1 SILICONE COMPRESSION SEAL® PROFILE; UNCOMPRESSED PROFILE DIMENSION 2-1/2" x 7/8"	115
FIGURE 4-29: ISOMETRIC DRAWING OF THE PCS-1 SILICONE COMPRESSION SEAL® INSTALLATION.	115
FIGURE 4-30: PHASE 2A-A, TL OF MULLIONS WITH 1/2" VERTICAL SEAL	120
FIGURE 4-31: PHASE 2A-B, TL OF MULLIONS WITH 1/2" AND 3/4" SEALS	123
FIGURE 4-32: PHASE 2A-C, TL OF HIGHER PERFORMING MULLION WITH SILICONE PARTITION CLOSURE®	126
FIGURE 4-33: PLAN DRAWING OF TL13-413 (LEFT) AND TL 416 (RIGHT)	126
FIGURE 4-34: SOUND TRANSMISSION LOSS CURVES OF TL13-413 AND TL13-416	127
FIGURE 4-35: TL OF HOLLOW/EXPOSED MULLION CONNECTED TO RIZZA SILICONE PARTITION CLOSURE®	129
FIGURE 4-36: PLAN DRAWING OF TL13-418 (LEFT) AND TL 420 (RIGHT)	130
FIGURE 4-37: SOUND TRANSMISSION LOSS CURVES OF TL13-418 AND TL13-420	130
FIGURE 4-38: TL SPECTRA OF ALL PHASE 2A TESTS	132
FIGURE 4-39: PLAN DRAWING OF TL13-413 (LEFT), TL13-417 (MIDDLE) AND TL 422 (RIGHT)	133
FIGURE 4-40: PHASE 2A MC-1 COMPARED TO A COMPOSITE OF MC-1 + SMALL DEFLECTION CONNECTION...	134
FIGURE 4-41: PHASE 2A MC-2 COMPARED TO A COMPOSITE OF MC-2 + SMALL DEFLECTION CONNECTION...	134
FIGURE 4-42: PHASE 2A MC-1 COMPARED TO A COMPOSITE OF MC-1 + LARGE DEFLECTION CONNECTION...	135
FIGURE 4-43: PHASE 2A MC-2 COMPARED TO A COMPOSITE OF MC-2 + LARGE DEFLECTION CONNECTION...	135
FIGURE 4-44: PHASE 2B: PLAN DIAGRAM OF UVM ELEMENTS AND ASSOCIATED TEST PHASES.....	136
FIGURE 4-45: PLAN DIAGRAM OF ACOUSTIC CONCEPT CONNECTIONS MEASURED IN PHASE 2B	137
FIGURE 4-46: PLAN DIAGRAM OF STAGGERED PLATE SPECIMEN	137
FIGURE 4-47: ELEVATION VIEW OF PHASE 2B TEST SPECIMENS IN FILLER WALL (LEFT – PARALLEL, RIGHT – STAGGERED)	138
FIGURE 4-48: PHASE 2B CLASS A SPECIMEN CONSTRUCTION OF SOLID PLATE TESTS	139
FIGURE 4-49: PHASE 2B CLASS B SPECIMEN CONSTRUCTION OF SOLID PLATE TESTS	140
FIGURE 4-50: TL OF "PARALLEL PLATES" WITH 6" AND 4" AIR SPACES	146
FIGURE 4-51: PLAN DRAWING OF CONNECTION ELEMENT TL13-612 (LEFT) AND UNITIZED MULLION TL13-311 (RIGHT).....	146
FIGURE 4-52: PHASE 2B ALUMINUM AND GYPSUM BOARD PLATE RESULTS	147
FIGURE 4-53: PHASE 2B CLASS A: ALUMINUM OR GYPSUM BOARD PLATE WITH AN MLV DAMPING LAYER	149
FIGURE 4-54: PHASE 2B CLASS B, MLV COMPOSITE WITH ALUMINUM OR GYPSUM BOARD PLATE	154
FIGURE 4-55: PHASE 2B CLASS B: MLV COMPOSITE WITH ALUMINUM OR GYPSUM BOARD PLATE	155
FIGURE 4-56: MULLION MATE® (LEFT) AND MULL IT OVER® (RIGHT)	157
FIGURE 4-57: MULLION MATE (LEFT) AND MULL IT OVER (RIGHT)	157
FIGURE 4-58: MULLION MATE (LEFT) AND MULL IT OVER (RIGHT)	158
FIGURE 4-59: TRANSMISSION LOSS RESULTS OF THE MULL IT OVER PRODUCT FROM WEAL.....	159
FIGURE 4-60: PHASE 3: PLAN DIAGRAM OF UVM ELEMENTS AND ASSOCIATED TEST PHASES	161
FIGURE 4-61: PHASE 1 CONFIGURATIONS USED AS THE CENTER VERTICAL MULLION IN PHASE 3.....	162

FIGURE 4-62: COUPLED SEMI-ANECHOIC CHAMBERS 3S AND 3R SHOWN IN PLAN WITHIN THE MAIN WEAL CHAMBERS.....	163
FIGURE 4-63: CURTAIN WALL BAY INSERTED INTO THE APERTURE OF THE FILLER WALL	164
FIGURE 4-64: CURTAIN WALL PLACED AND CENTERED IN THE FILLER WALL.....	164
FIGURE 4-65: CHAMBER 3S (BUILT WITHIN THE WEAL SOURCE CHAMBER)	164
FIGURE 4-66: CHAMBER 3R (BUILT WITHIN THE WEAL RECEIVING CHAMBER)	164
FIGURE 4-67: CHAMBER 3S AND 3R PLAN DRAWINGS AND ACOUSTIC DETAILS	165
FIGURE 4-68: WEAL CHAMBER [SECTION]	166
FIGURE 4-69: WEAL CHAMBER [ELEVATION]	166
FIGURE 4-70: CHAMBER 3S AND 3R PLAN DRAWINGS AND ACOUSTIC DETAILS	168
FIGURE 4-71: SUMMARY OF STC RANGES AT EACH UVM TEST PHASE.....	169
FIGURE 5-1: DRAWING OF MULLION SECTION WITH IDENTIFIED FACE AREAS OF EACH CURTAIN WALL ELEMENT: TRANSOM (0.16 SF), GLASS (0.7 SF), MULLION (2.42 SF), AND SILL (0.16 SF).....	174
FIGURE 5-2: TL13-311 (UNCONNECTED MULLION)	175
FIGURE 5-3: TL14-170 (CONNECTED MULLION)	175
FIGURE 5-4: NOISE REDUCTION SPECTRA BETWEEN TL13-311 AND TL14-170	175
FIGURE 5-5: TL13-316 (UNCONNECTED)	177
FIGURE 5-6: TL14-168 (CONNECTED).....	177
FIGURE 5-7: NOISE REDUCTION SPECTRA BETWEEN TL13-316 AND TL14-168	177
FIGURE 5-8: TL13-323 (UNCONNECTED)	179
FIGURE 5-9: TL14-167 (CONNECTED).....	179
FIGURE 5-10: NOISE REDUCTION SPECTRA BETWEEN TL13-323 AND TL14-167	179
FIGURE 5-11: NOISE REDUCTION SPECTRA BETWEEN TL13-311 AND TL13-323	181
FIGURE 5-12: NOISE REDUCTION SPECTRA BETWEEN TL14-170 AND TL14-167	182
FIGURE 5-13: UNCONNECTED MULLION WITH GYPSUM BOARD OVERCLAD, TL13-325, STC 42 5/8"	184
FIGURE 5-14: TRANSMISSION LOSS EXTRAPOLATION OF TL13-325 IF TESTED WITH THE CURTAIN WALL SYSTEM	185
FIGURE 5-15: IDENTIFICATION OF ELEMENTS USED FOR THE COMPOSITE CALCULATIONS AND ASSOCIATED SURFACE AREAS.....	186
FIGURE 5-16: TL13-311, STC 36.....	187
FIGURE 5-17: TL13-323, STC 52.....	187
FIGURE 5-18: TL13-621, STC 37, STAGGERED PLATE WITHOUT SEALS	187
FIGURE 5-19: TL13-622, STC 51, STAGGERED PLATE WITHOUT SEALS.....	187
FIGURE 5-20: TL14-170, STC 37 PLAN DRAWING OF UVM HOLLOW AND EXPOSED	188
FIGURE 5-21: TL14-167, STC 42 PLAN DRAWING OF UVM FILLED AND OVERCLAD	188
FIGURE 5-22: NRC-CNRC LABORATORY TEST TL-93-302 PERFORMANCE IN OCTAVE BAND CENTER FREQUENCIES.....	189
FIGURE 5-23: COMPOSITE PREDICTION OF A LOW PERFORMING CURTAIN WALL JUNCTION.....	190
FIGURE 5-24: COMPOSITE PREDICTION OF A LOW PERFORMING CURTAIN WALL SYSTEM WITH GLASS.....	191
FIGURE 5-25: COMPOSITE PREDICTION OF A HIGH PERFORMING CURTAIN WALL JUNCTION	192

FIGURE 5-26: COMPOSITE PREDICTION OF A HIGH PERFORMING CURTAIN WALL SYSTEM WITH GLASS	193
FIGURE 5-27: STC SUMMARY ACROSS ALL LABORATORY TESTS	196
FIGURE 5-28: PRELIMINARY RANKING OF UVM TEST ELEMENTS	198
FIGURE 6-1: LIMITED SPECTRUM WITH CURTAIN WALL DESIGN	204
FIGURE 6-2: LIMITED SPECTRUM WITH CURTAIN WALL DESIGN	206
FIGURE A- 1: NON-UNITIZED (STICK) SYSTEM	219
FIGURE A- 2: UNITIZED SYSTEM	220
FIGURE A- 3: FLANKING PATH DIAGRAM (MOMMERTZ & MULLER, 2008)	222
FIGURE A- 4: APPROXIMATE SOUND SPECTRA OF MALE AND FEMALE SPEECH (LOG-TERM AVERAGE)	222
FIGURE A- 5: SECTION OF LABORATORY TRANSMISSION LOSS TESTING CHAMBER	227
FIGURE A- 6: FIELD CONDITION FOR IN-SITU TRANSMISSION LOSS TESTING	228
FIGURE A- 7: DIFFERENCE BETWEEN LABORATORY AND FIELD TRANSMISSION LOSS TESTS	228
FIGURE C- 1: PHASE 1-A TRANSMISSION LOSS CURVES	314
FIGURE C- 2: 4" AIRSPACE COMPARISON, MULLION AND PLATE CONNECTION	315
FIGURE C- 3: 3" AIRSPACE COMPARISON, MULLION AND PLATE CONNECTION	316
FIGURE C- 4: 3" AIRSPACE AND BATT INFILL COMPARISON, MULLION AND PLATE CONNECTION	317
FIGURE C- 5: 3" AIRSPACE AND GYPSUM OVERCLAD, MULLION AND PLATE CONNECTION	318
FIGURE C- 6: PHASE 2B PARALLEL PLATE TESTS WITH 3" AIR CAVITIES	319
FIGURE C- 7: SOUND TRANSMISSION LOSS OF ALUMINUM PLATES ONLY WITH 3", 4" OR 6" AIR CAVITY	320
FIGURE C- 8: TL SPECTRA OF PH3-MC1 WITH PH1-MC1 AND PH3-MC2 WITH PH1-MC2	321
FIGURE C- 9: TRANSMISSION LOSS COMPARISON BETWEEN CONTROL MULLIONS MC1 AND MC2	322
FIGURE C- 10: PHASE 1-MC1 (TL13-311) AND PHASE 3-MC1 (TL14-170)	322
FIGURE C- 11: PHASE 1-M1A (TL13-316) AND PHASE 3-MC1A (TL14-168)	323
FIGURE C- 12: PHASE 1-MC2 (TL13-323) AND PHASE 3-MC2 (TL14-167)	323
FIGURE C- 13: TL PLOTS OF PHASE 1 (MC1/1A) AND PHASE 3 (MC1/1A)	324
FIGURE C- 14: TL PLOTS OF COMPARISON MC1 AND MC1A	325
FIGURE D- 1: TYPICAL LOCATION OF THE ACCELEROMETERS AT THE SOURCE AND RECEIVING CHAMBERS	326
FIGURE D- 2: PLAN DRAWING OF WEAL TEST CHAMBERS AND PHASE 3 TEST RIG 3S/3R CHAMBERS	328
FIGURE D- 3: ELEVATION A: VIEW OF ACCELEROMETER LOCATIONS ON CHAMBERS 3S AND 3R FOR EV2	328
FIGURE D- 4: AXIS DESIGNATION FOR VIBRATION MEASUREMENTS	330
FIGURE D- 5: EV1 [Av] CURTAIN WALL ELEVATION WITH 3R CHAMBER ACCELEROMETER LOCATIONS 02, 08, 03	335
FIGURE D- 6: EV2 [Bv] CURTAIN WALL ELEVATION WITH 3R CHAMBER ACCELEROMETER LOCATIONS 02, 05, 03	336
FIGURE D- 7: EV1 – MEASURED ACCELERATION LEVELS (dB)	339
FIGURE D- 8: EV2 – MEASURED ACCELERATION LEVELS (dB)	339

FIGURE D- 9: EV1 – CALCULATED ACCELERATION (M/S²) 340

FIGURE D- 10: EV2 – CALCULATED ACCELERATION (M/S²) 340

FIGURE D- 11: EV1 – CALCULATED VELOCITY (M/S) 340

FIGURE D- 12: EV2 – CALCULATED VELOCITY (M/S) 340

FIGURE D- 13: EV1 – CALCULATED SOUND PRESSURE LEVEL (dB)..... 341

FIGURE D- 14: EV2 – CALCULATED SOUND PRESSURE LEVEL (dB)..... 341

FIGURE D- 15: EV1 – CALCULATED SOUND POWER LEVEL (dB) 341

FIGURE D- 16: EV2 – CALCULATED SOUND POWER LEVEL (dB) 341

FIGURE D- 17: EV1, PREDICTED AND MEASURED SOUND PRESSURE LEVELS 342

FIGURE D- 18: EV2, PREDICTED AND MEASURED SOUND PRESSURE LEVELS 343

FIGURE D- 19: SUMMARY OF SOUND POWER AT EACH UVM MEASURED DURING PHASE 3 343

ABSTRACT

“Cohesion is a measure of how well the parts of a component ‘belong together.’ Cohesion is strong if all parts are needed for the functioning of other parts. Strong cohesion promotes maintainability and adaptability by limiting the scope of changes to a small number of components.”¹

The glass curtain wall is a cohesive design of glazing, aluminum framing, structural silicone, and neoprene gasketing. These components for unitized and non-unitized systems are technologically sophisticated and work together as a complex dynamic system. The intricate design accounts for the architecture of structural deflections, thermal properties, acoustic performance, moisture control, fire and smoke protection, amongst others. Therefore, the design and installation of these of these components should work cohesively together to provide an effective building performance, including provisions for good sound isolation. The sound isolation between occupied adjacencies located at the façade is highly influenced by the architectural composite of the various elements. Additionally certain parts within the composite can transfer sound energy more efficiently than others via sound flanking transmission paths.

Sound flanking transmission that exists at the façade curtain wall and interconnecting partition presents a design challenge that reduces acoustic privacy and sound isolation design targets. This intersection can create an acoustic weakness within the curtain wall assembly and where it fastens to the building.

Three architectural elements commonly contributing to this weakness are the curtain wall infill glazing, the aluminum mullion extrusions, and the partition connection joining the mullion to an interconnecting partition. The behavior of sound flanking transmission paths across each of these curtain wall elements is currently not well understood for all systems. These architectural mechanisms can create lateral sound paths and degrade the overall sound isolation integrity of the composite architecture. This is especially an issue when a high sound isolation performance between adjacent spaces is expected from an acoustically rated partition.

Research on sound flanking paths in curtain wall systems has been carried out in theoretical statistical energy analysis (SEA) models, sound isolation prediction simulations, and with physical measurements on laboratory and field installations. However, most of these studies are composite and do not necessarily investigate the specific behavior of the separate system components. Typically the sound isolation performance of mullions measured in a laboratory or field may not clearly identify which curtain wall element most significantly contributes to overall performance. Acoustic products for curtain wall systems are emerging with the intent to improve overall sound isolation performance, which is an indication that this problem impacts the architectural practice.

In order to improve the acoustic performance of the curtain wall system, the critical components attributed to the sound flanking transmission paths must be better understood, particularly at the mullion. Three elements associated with the architecture of the curtain wall system were selected and studied through a series of laboratory test measurements and sound isolation prediction calculations to determine potential improvement: the partition connection, the vertical mullion, and the curtain wall glazing. The testing method proposed is in accordance with ASTM E90, an acoustic testing procedure that

¹ Man Lin, “Chapter 6 Architectural Design, Computer Science CSci485,” 2012, <http://cse.stfx.ca/~mlin/cs485/lectures/archdesign.ppt>.

measures the transmission loss (TL) of a building specimen between two reverberant test chambers. The single figure STC classification per ASTM E336 is obtained from these measurements. The STC is a commonly used amongst architects in practice to identify the sound level resistance of walls and floors. Approximately 80 acoustic laboratory tests were performed on select curtain wall elements and modified to identify the highest practicable acoustic performance that may be achieved. Additionally, an auxiliary set of vibration measurements were conducted at one of the test stages in order to examine the acoustic energy injection at mechanically connected elements of the curtain wall system.

Comparisons between the independent test elements were examined in order to understand construction and performance benefits associated with achievable performance. The sound transmission loss data obtained from the laboratory test procedure is analytically calculated with the performance of an interior partition assembly to understand composite effects. Results from this testing method indicate how the performance of individual components influences a composite system and identifies elements that limit the achievable sound isolation. Although global variations of curtain wall designs exist in practice, the conclusions developed from the proposed experiment method are relevant to the specific curtain wall specimen typology measured and have relevance to similar systems.

The research aims to enhance façade tectonic cohesion specific to acoustic design integration and to inform building engineering design and performance decisions.

TERMS & ABBREVIATIONS

ACOUSTIC TERMS/TEST

See Appendix A for acoustic definition of terms and test procedures.

ACOUSTIC ABBREVIATIONS

ATI	Architectural Testing, Inc. <i>Institute for testing and certifying building products and constructions</i>
ASTM	American Society for Testing & Materials
CW	Curtain Wall
UVM	Unitized Vertical Mullion <i>Refers to the UVM test methodology; the test method considers two associated mullion elements: glass and partition connection.</i>
CVM	Center Vertical Mullion <i>Used in reference to the curtain wall test specimens in Phase 3. Modifications in this phase were made to the center vertical mullion; vertical mullions were located at the outer edge of the bays.</i>
IGU	Insulated Glazing Unit
L_p	Sound Pressure Level (dB)
L_w	Sound Power Level (dB)
L_{eq}	Equivalent Sound Level, over a period of time
MC	Mullion Constant <i>Mullions defined in Chapter 4 as MC1 and MC2. MC1 defines the lowest performing baseline and MC2 defines the highest performing.</i>
MLV	Mass Limp Vinyl
NR	Noise Reduction
R	Acoustic Index - Sound Reduction Index, laboratory measurement
R_w	Acoustic Index - Sound Reduction Index, laboratory measurement, weighted
R'	Acoustic Index – Apparent Sound Reduction Index, field measurement
R'_w	Acoustic Index – Apparent Sound Reduction Index, field measurement, weighted
SEA	Statistical Energy Analysis
STC	Acoustic Index - Sound Transmission Class
TL	Sound Transmission Loss

VEC Vertical Edge Connection

The vertical edge connection (VEC) is referenced in Chapter 4 during Phase 2 to define the various test conditions at the vertical edge of a building specimen, i.e. resilient acoustic seal, partition connection.

WEAL Western Electro-Acoustic Laboratory

The laboratory in Santa Clarita, CA where all specimens of the UVM test were measured.

CHAPTER 1 INTRODUCTION TO CURTAIN WALL SOUND FLANKING TRANSMISSION

1.1 ACOUSTIC RELEVANCE TO GLASS CURTAIN WALL DESIGN

Lateral and vertical sound transmission across a façade limits the potential sound isolation between spaces and is rarely considered in the design of glass curtain wall construction. Acoustic concerns typically concentrate on sound transmission from environmental noise through the facade. However these sound flanking paths across the façade compromise the interior sound isolation and transmit acoustic energy by way of structural paths connected to the curtain wall, such as at the vertical mullion, horizontal mullion, glass infill, partition connection, floor slab connection, etc. Interior sound isolation is degraded as a result of these acoustic weaknesses. Flanking transmission paths can be both lateral and vertical (Figure 1-1).

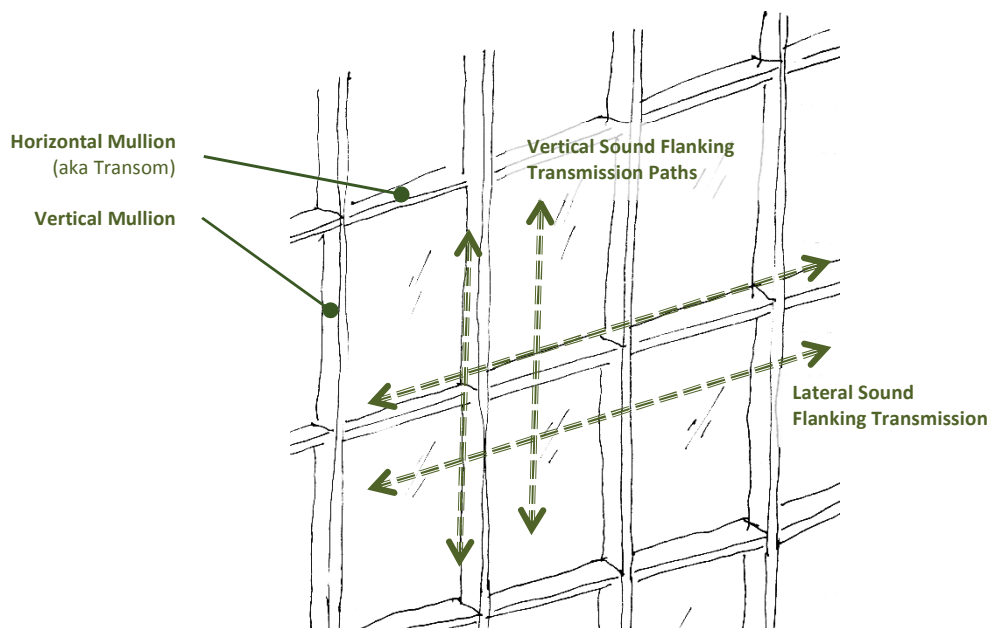

FIGURE 1-1: DIAGRAM OF SOUND TRANSMISSION PATHS AT THE CURTAIN WALL FACADE

Since structural paths at the curtain wall are numerous, the scope of this research is limited to the lateral sound transmission across three select façade elements to study limitations of their inherent structure: (1) the vertical mullion, (2) its connection condition to an interior partition, and (3) a composite of the curtain wall glazing and horizontal mullions. Sound transmission loss (TL) measurements from these component investigations are analytically studied to evaluate frequency regimes, trends, and correlations with respect to performance and material assemblies.

Although this acoustic relevance to the curtain wall system is important, its design is engineered to perform other multi-disciplinary functions that cohesively integrate tectonic interactions including structural deflection, thermal resistance, fire and smoke protection, and architectural detailing.

This integrated engineering has various design impacts relevant to the acoustic performance and specification of the curtain wall (Figure 1-2).

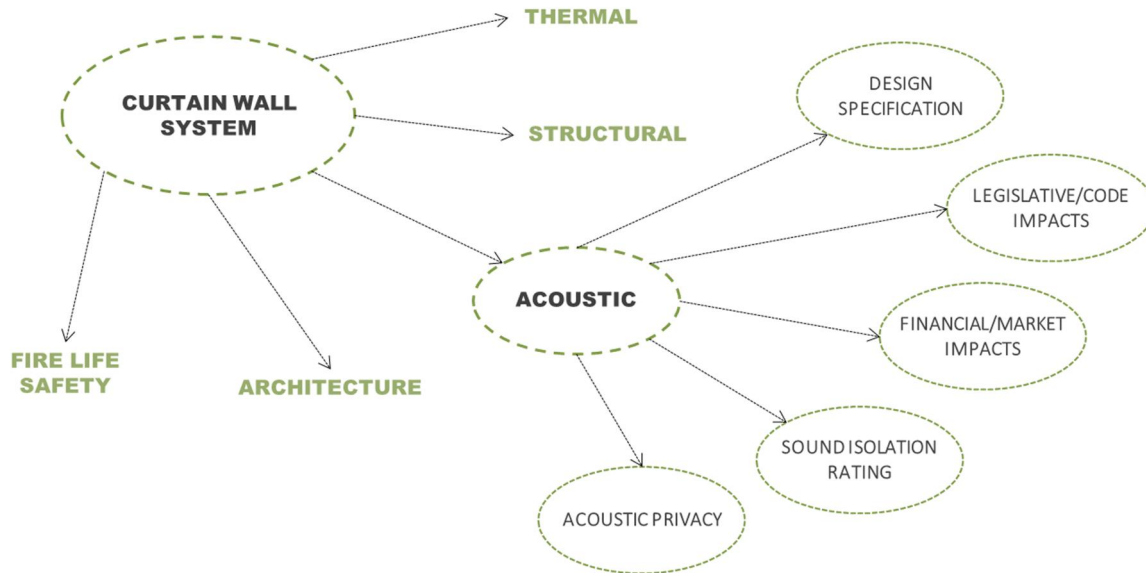

FIGURE 1-2: DESIGN CONSIDERATIONS REQUIRED AT THE CURTAIN WALL SYSTEM INCLUDING ACOUSTICS

Part of the quality assurance in architecture is meeting the acoustic performance targets as practically and cost effectively as possible. Therefore, methods to meet noise reduction criteria (e.g. STC, NIC, etc.) with the potentially limiting connections at the façade and building interior must be considered.

Sound isolation performance indices in the USA typically assign sound transmission class (STC) ratings between noise sensitive adjacencies. The STC is a single figure rating that defines how effectively a building element (e.g. wall or floor) resists airborne sound transmission. This type of performance criteria is commonly used to reduce disturbance between adjacent spaces during simultaneous activities and is an index regularly recognized by architects. The STC performance is evaluated in an acoustic laboratory where the building test specimen is mounted between source and receiving chambers and measured for transmission loss. The testing procedure required to obtain the STC rating takes into account the overall radiating surface area of the building specimen, which includes acoustic mechanisms influencing sound flanking transmission. The STC measurement and testing standard procedure is defined in Chapter 2 and Appendix A.

High-rise residential design requires demising partitions with high STC target ratings between dwellings. The interior partition plus its edge connections at the façade, floor, and ceiling will contribute to meeting this criteria to target good levels of acoustic privacy. Occupants expect robust sound isolation from adjacent neighbors in a multi-unit high-rise tower. “The design and construction of multifamily dwellings must include consideration of privacy, which in many cases is legally mandated, even if it is not controlled by a building code or property line ordinance, it nevertheless forms part of the basis of the home buyer’s or occupant’s reasonable expectation of quality.”²

Often the curtain wall design will require some form of acoustic intervention where high sound isolation is required. One example of this is at the hotel and residential tower at the LA Live development located in Los Angeles, CA (FIGURE 1-3). Concern for vertical sound flanking transmission at a double story height mullion system was brought to the attention of the curtain wall designers, Enclos Corp. This initiated a

² Marshall Long, *Architectural Acoustics* (Elsevier, 2006), 509.

series of unique acoustic amelioration tests by the design team. The inherent condition impacted the design process, building specification and detailing, and building material cost.



FIGURE 1-3: L.A. LIVE TOWER AND RESIDENCES, LOS ANGELES, CA (IMAGE COURTESY OF © 2015 ENCLOS CORP)

Acoustic performance implications associated with façade sound flanking at high-rise occupancies in the commercial, retail, healthcare, education, or residential sectors include

- Client expectation and criteria targets for the use and quality of the space.
- Speech privacy and confidentiality degraded between adjacent spaces laterally and vertically.
- Simultaneous activity between adjacencies is compromised.
- Issues relating to cost effectiveness. The sound isolation performance of robust partitions is devalued.
- Future building market forecast for an increased demand in residential buildings. Therefore design requirements and space planning issues will be more onerous.
- Healthcare, residential, and building code violations.
- Health risk including loss of sleep, reduced healing environment, stress, and loss of productivity.

These emphasize the importance of maintaining sound isolation that is consistent with various elements.

1.2 PROBLEM STATEMENT AND HYPOTHESIS

Sound flanking transmission paths reduce the achievable sound isolation between adjacent spaces located at the façade. A demising partition may be built to a STC 55 specification, however once attached to the glass curtain wall system, the composite of the all parts may reduce the performance in excess of 10 – 20 STC points (FIGURE 1-4). Much of the performance reduction is attributed to sound traveling across the path of least resistance, e.g. light-weight building components. A glass curtain wall is considered a light-weight building component as opposed to a concrete floor slab which is significantly heavier.

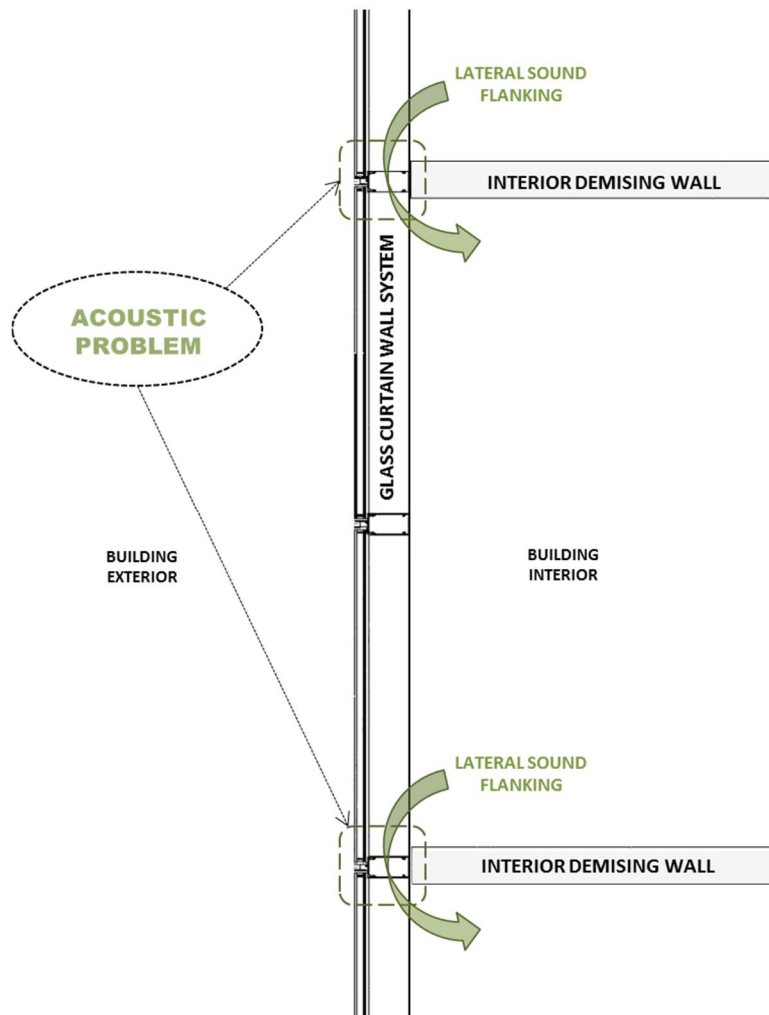

FIGURE 1-4: PLAN DIAGRAM, LATERAL SOUND FLANKING PATH AT THE INTERFACE BETWEEN A CURTAIN WALL SYSTEM AND INTERIOR DEMISING PARTITION

This limitation is well known to acoustical consultants. Recent publications identify the design and development of acoustic detailing at high-rise structures and discuss the common sound flanking issue at the intersection of demising partitions and the curtain wall (for example LoVerde and Dong, 2008).³

³ John LoVerde and Wayland Dong, "Methods for Reducing Flanking Airborne Noise Transmission through Mullions of Curtain Wall Systems," *The Journal of the Acoustical Society of America* 124, no. 4 (2008): 2463.

Industry manufacturers are also addressing the sound flanking issue. Products for curtain wall systems are being designed to mitigate sound transmission by applying appendages to the mullion. Manufactured product options are listed in Chapter 2.

Additionally, curtain wall specifications may include acoustic clauses to address sound flanking concerns, but the language used may be difficult to enforce or lack responsible entities, such as in this example: “Sound flanking transmission at demising walls and floors must be avoided through correct design and detailing.”

The acoustic weakness of this interface is attributed to lightweight building components that are designed to resiliently connect the curtain wall mullions to the building (FIGURE 1-4). Although design resolutions have been identified in architectural acoustic practice, it still remains unclear what components of the system are primarily impacting the overall STC performance, both individually and on the assemblage. These components become mechanisms for lateral sound paths and degrade the integrity of the overall sound isolation of the curtain wall and interconnecting partition.

Hypothesis:

Sound transmission loss testing of individual and composite architectural elements comprised of and associated with the intersection of the unitized vertical mullion reveals sound flanking path mechanisms controlling the overall sound isolation performance.

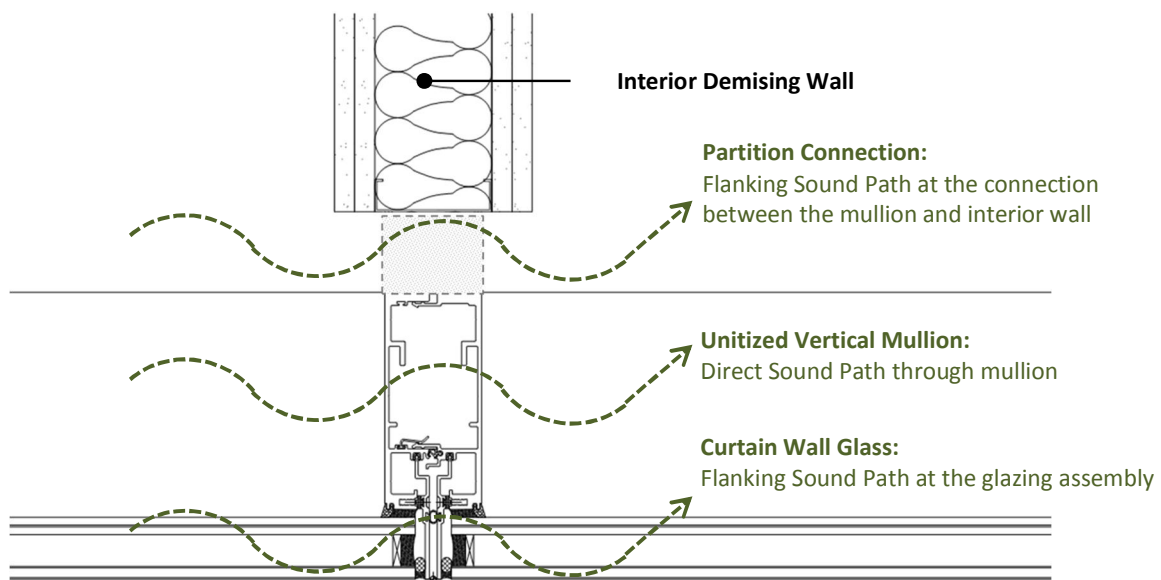

FIGURE 1-5: PLAN DIAGRAM OF A UNITIZED MULLION SYSTEM CONNECTED TO AN INTERIOR WALL PARTITION; THREE SOUND PATHS IDENTIFIED.

Although many sound paths occur at the unitized mullion, three lateral sound paths are under consideration. Each of these paths is associated with one of the following curtain wall elements: interior wall connection, curtain wall mullion, and curtain wall glass. These sound paths are typical at most unitized curtain wall mullion systems.

1. The sound path at the **partition connection** is located between the mullion and demising wall.

2. A direct sound path is located at the **curtain wall mullion** extrusion.
3. The sound flanking path located at the **curtain wall glass** occurs due to flexural waves from acoustic energy excited from a source room and transmitting to a receiving room.

Improvements to each building element should not be judged in isolation, and sound flanking at the curtain wall glazing is not typically accounted for as a target for mitigation. The commercial designs for mullion enhancements may show high TL values, but those may be reduced in a real installation by other flanking paths, including across the curtain wall glazing.

1.2.1 BUILDING SOUND FLANKING PATHS

Sound flanking transmission is inherent to building design, and their paths occur wherever building elements join. It is not exclusive to the curtain wall system. Sound flanking may be defined as the transmission of acoustic energy around a primary sound isolation barrier; this is also known as an indirect sound path. An acoustic intersection detail may indicate the vertical mullion as the primary barrier and the interior wall connection and curtain wall glazing are flanking paths (Figure 1-5). At a larger scale, the primary barrier may be the interior demising wall (Figure 1-6).

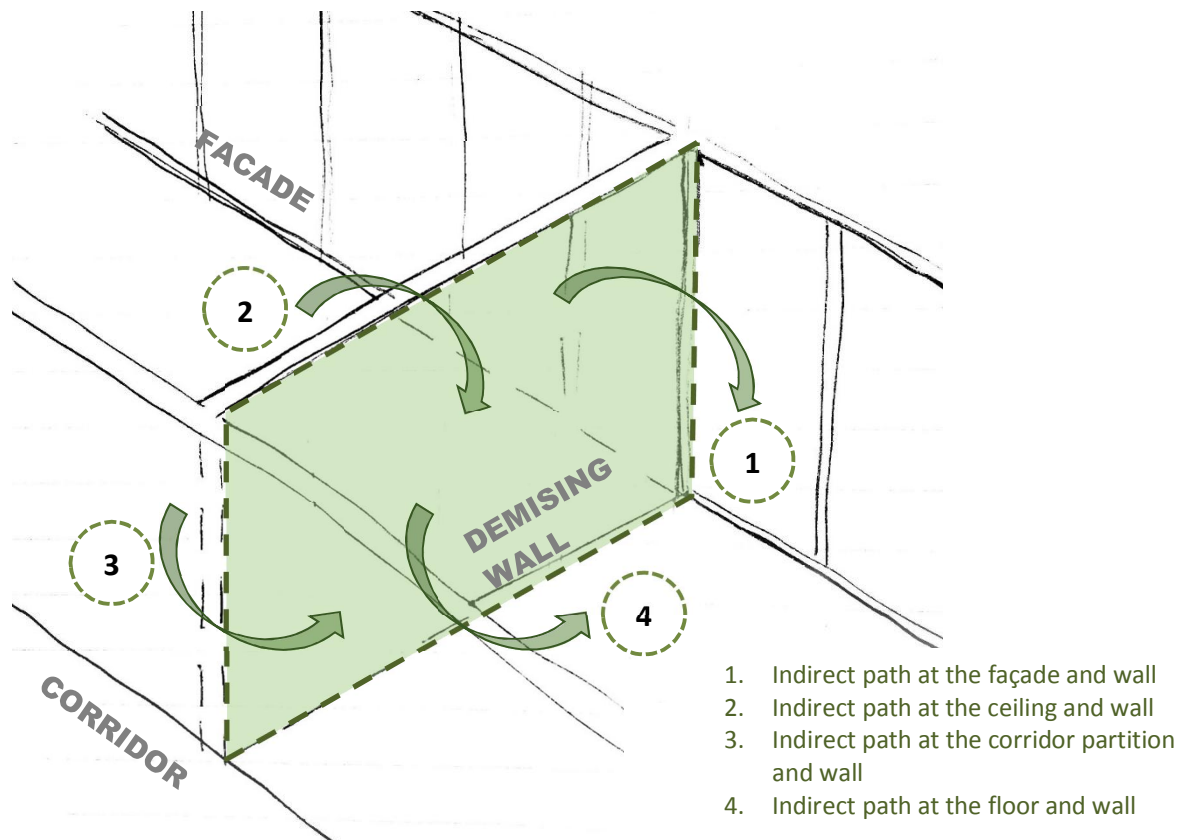

FIGURE 1-6: DIAGRAM SHOWING FOUR JUNCTIONS AT A DEMISING WALL

The overall sound isolation performance between the two spaces is dependent on the resistance of sound energy through the demising wall and its edge flanking. There are four edge flanking conditions at a

demising wall: at the facade, at the floor, at the adjacent interior wall (often at a corridor), and at the ceiling where sound flanking or acoustical leaks may occur (Figure 1-6). Sound flanking is defined as sound transmission through building components; an acoustic leak is defined as sound transmission through air gaps or holes where they occur in the building construction.

The sound paths at the façade and interior wall will vary based on the context of the building design, construction, and deflection requirements for wind and/or seismic loads. “The effect of flanking sound is to lower the achieved sound insulation between adjacent areas below that which would be expected from the known performance of the identified dividing barriers. Because flanking sound is always present (other than within the ideal confines of an acoustic laboratory) practical site performance between non-isolated’ constructions will be limited...”⁴

1.2.2 COMPOSITE TRANSMISSION LOSS

“The sound isolation between rooms is dependent mainly on the mass of the separating wall and composites like doors or windows and the degree to which they are sealed airtight.”⁵ The overall sound isolation performance between the two spaces will be the cumulative effect of the direct sound through the demising partition and the many indirect paths through the coupled intersection at its edges (Figure 1-6). The composite sound transmission loss performance will consist of the TL for each individual element and its relative area.

It can be challenging to identify the individual architectural element that most significantly controls the resultant TL rating. It has not yet been determined in practice which of the three elements identified in Figure 1-5 limits the overall sound isolation rating of the composite system shown.

A further discussion of composite TL is provided in Chapter 2.

⁴ Association of Interior Specialists, “Building Acoustics - Terminology,” *AIS Association of Interior Specialists*, accessed April 6, 2014, <http://www.bre.co.uk/page.jsp?id=1146>.

⁵ B. J. Smith, R. J. Peters, and S. Owen, *Acoustics and Noise Control*, 2 Sub (Addison Wesley Longman, 1996), 67.

1.3 OVERVIEW OF RESEARCH

This research investigates the lateral sound flanking at the connection between the demising partition and the façade at the curtain wall.

This is important to note especially in the review of sound transmission loss test reports for curtain wall mullions. A composite performance is typically shown with a demising partition but without the glass infill. Therefore it is difficult to determine what the composite TL will be in an actual project because one cannot identify the TL of the individual components or their interaction. The sound isolation behavior of a singular component is therefore difficult to identify.

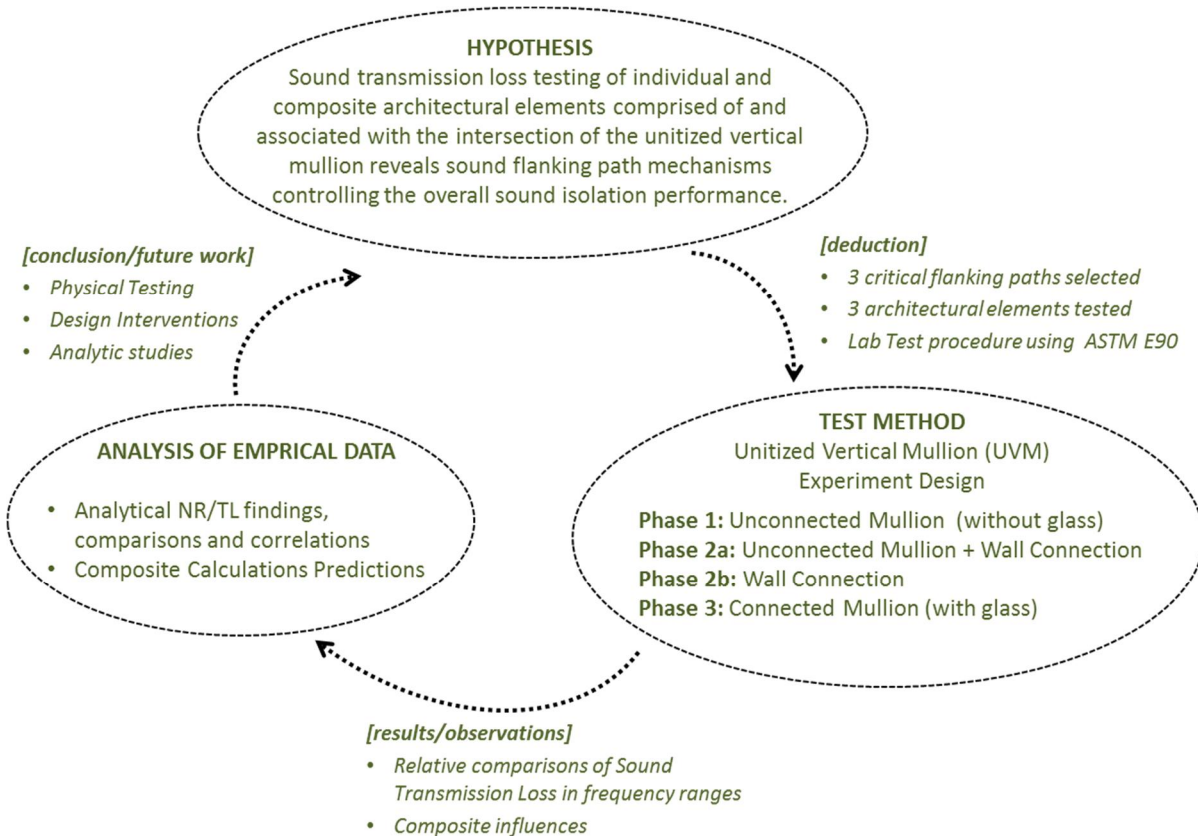

FIGURE 1-7: DIAGRAM OF RESEARCH DESIGN

The structure of the research and method will begin with the objectives which support the hypothesis, including a course to set up the proposed empirical test method used to support an analysis method (FIGURE 1-7). Vertical sound flanking transmission across curtain wall elements also occurs in practice but will not form part of this research study.

1.3.1 RESEARCH OBJECTIVES

There are four research objectives. Objective 1 reviews practices to modify curtain wall elements and procedures to measure them. Objective 2 develops the experiment design to measure unitized vertical mullions. The results from the empirical testing conducted in Objective 2 will be applied to two different analytical analysis methods to meet Objectives 3 and 4.

1. **Identify curtain wall mullion design practices and procedures.** Investigate methods used in practice to modify curtain wall elements and review current sound isolation metrics and measurement methods to identify uncertainties in current design and test procedures.
2. **Develop an experiment methodology for unitized vertical mullion measurements.** Develop a test method to measure the unitized vertical mullion and associated connections individually in accordance with ASTM E90 and without the influence of a composite demising wall. The approach will define *connected* versus *unconnected* mullion conditions. Objective 2 is applied to two different analytical analysis methods to meet Objectives 3 and 4.
3. **Identify controlling sound paths at the unitized vertical mullion.** Evaluate the sound transmission loss of *connected* and *unconnected* mullion conditions to identify controlling frequency regimes, trends and correlations between curtain wall elements.
4. **Determine the acoustic relationship between vertical mullion and interconnecting walls.** Determine impacts to the demising partition using the composite transmission loss prediction method. This will include the performance and areas of the curtain wall elements and demising wall partition to provide information where diminishing returns occur between acoustic performance and material construction.

1.3.2 RESEARCH METHOD

1. Identify existing methods of measuring transmission loss in curtain wall systems.
2. Identify current architectural interventions to improve the sound isolation performance.
3. Expand on precedent research to develop a test experiment to measure individual components of the curtain wall system.
4. Design a test experiment to measure the three elements identified in the scope of the research study and develop modifications to measure for each element. These elements include the vertical mullion, the partition connection and the curtain wall glazing.
5. Profile the one-third octave band transmission loss, frequency regimes, and acoustic ratings from the empirical measurements of each element.
6. Isolate the sound isolation performance of the connection between the mullion and the interior wall including tolerances required for structural and thermal façade performances, for example structural deflection and thermal expansions.
7. Measure the sound transmission loss of the unitized vertical mullion including the addition of the curtain wall glazing in a system that simulates an outdoor condition to measure only sound energy across the curtain wall and remove the influence of sound energy passing through the curtain wall.

8. Compare the composite sound transmission loss predictions with a higher performing demising wall to evaluate limitations.

1.3.3 APPROACH TO MEASURING THE TEST SPECIMENS

The curtain wall system used is detailed in Chapter 3 and consists of a unitized vertical mullion connected to a glass curtain wall bay on either side with glass-infill and horizontal mullions. The experiment is designed to acoustically test specimens of mullions both connected and unconnected to the curtain wall system. Additionally, concept partition connections are tested with and without the vertical mullion. All test measurements are in accordance with the ASTM E90 *Test Method for Laboratory Measurement of Airborne Sound Transmission Loss of Building Partitions and Elements*.

As a means for relative performance comparisons, each building specimen is measured with modifications typically seen in practice based on findings from Objective 1. Modifications to the building specimens are made with the intent to identify the highest practicable sound transmission loss achievable and as a means for relative comparison.

This experiment is divided into three test phases based on three lateral sound paths:

- Phase 1** Sound path through the unconnected aluminum mullion extrusion
- Phase 2** Sound path at the partition connection between the mullion and interior partition
 - A. Partition connection with the unconnected mullion
 - B. Partition connection without the unconnected mullion
- Phase 3** Sound Path through acoustic vibration transmission at the composite curtain wall glazing

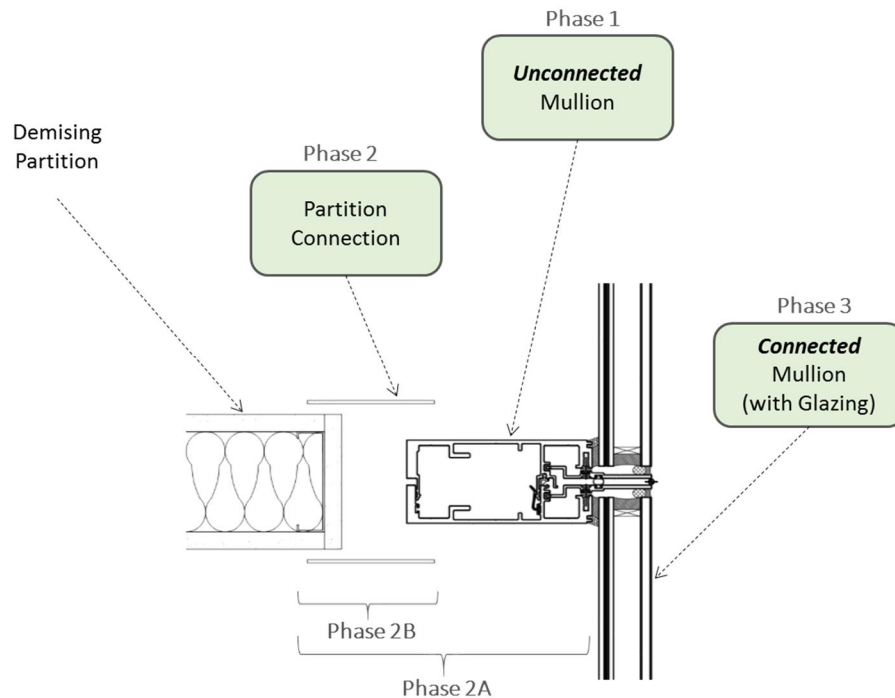

FIGURE 1-8: PLAN DIAGRAM OF THE EXPERIMENT TEST PHASES DEFINED BY THREE CURTAIN WALL SPECIMENS

The test method designed for measuring the lateral sound transmission of this curtain wall typology and its associated parts under relative laboratory setup conditions is unprecedented.

The data obtained from the empirical test data will be analytically analyzed in Chapter 5 to identify controlling architectural mechanisms and the influence these specimens may have on the demising wall system.

1.4 DISSERTATION OUTLINE

The research study is organized into 7 chapters.

Chapter 1 Introduction to Curtain Wall Sound Flanking Transmission	The sound flanking transmission at curtain wall systems is defined. The research objective and architectural acoustic test methods are described specifically for lateral sound flanking at unitized curtain wall mullions.
Chapter 2 Façade Background Review and Professional Applications in Acoustics	Background of the current testing and research approach to reduce sound flanking is explained. This includes global test methods, manufactured products, and precedent building measurements.
Chapter 3 Unitized Vertical Mullion Test Method	This describes the test experiment procedure and phases (1, 2A, 2B, 3) for the Unitized Vertical Mullion (UVM) test method. This includes the proposed specimens and required test chamber conditions.
Chapter 4 Test Results and Analysis of the Unitized Vertical Mullion Measurements	This includes the sound transmission class (STC) results of 80+ acoustic laboratory tests. These are organized by test phase. The details of the laboratory chamber conditions and final specimens tested at each phase are reported.
Chapter 5 Analysis of Controlling Mechanisms and Composite Transmission Loss	Sound transmission loss (TL) of frequency ranges are compared and analyzed between phases. Results from the UVM test method are applied to composite TL predictions.
Chapter 6 Conclusion	A summary of the objective conclusions and contributions is presented.
Chapter 7 Future Work	Test measurements and analytical studies based on findings from the UVM test method are proposed for future work.
Appendix A Terminology	Acoustic terminology relevant to the research work is defined.
Appendix B UVM Laboratory Test Results	One-third octave band results for all laboratory tests conducted at WEAL are given.

Appendix C Ancillary Sound Analysis	Additional WEAL test results comparison and correlations are shown.
Appendix D Ancillary Vibration Analysis	Vibration measurement test results conducted during the Phase 3 curtain wall bay test and analysis are provided.

TABLE 1-1: DISSERTATION OUTLINE

CHAPTER 2 FAÇADE BACKGROUND REVIEW AND PROFESSIONAL APPLICATIONS IN ACOUSTICS

This chapter provides background to the architecture of the glass curtain wall and acoustically relevant characteristics. The approach to acoustic design practices and procedures are also discussed specifically to sound isolation testing standards and current methods used in practice to improve acoustic performance. In addition, precedent research and case studies were investigated to provide an understanding of performance data analyzed in the design practice. The chapter is divided into four sections:

1. Acoustic Detailing at the Curtain Wall Mullion
2. Acoustic Mitigation Practices and Products for Mullions
3. Sound Isolation Test Measurement Metrics and Methods
4. Acoustic Precedent Research Studies of Curtain Wall Systems

2.1 ACOUSTIC DETAILING AT CURTAIN WALL MULLIONS

This section investigates the anatomy of the unitized curtain wall system and how the design leads to sound path weaknesses. The acoustic detailing of this architectural system is therefore important to reduce sound flanking transmission.

2.1.1 THE ANATOMY OF THE GLASS CURTAIN WALL

Studying the anatomy of the unitized glass curtain wall systems can help identify mechanisms where sound flanking paths occur. A glass curtain wall system is defined as an aluminum framed wall grid containing glass infill panels or opaque infill panels of metal or thin stone.⁶ Curtain wall system selection drives a large part of the design process, performance, construction administration, building aesthetic, and cost. Systems are supplied by manufacturers as off-the-shelf or custom designed solutions.

A unitized curtain wall system is modular, as opposed to a non-unitized or stick system. Unitized systems are the focus of this research study. They are built and prefabricated in a factory as modular units composed of a 4-sided perimeter of half mullions fastened to an insulated glazing unit (IGU) infill. The prefabricated units are shipped to site and connected directly to the building. An anchoring system is needed to connect the units to the floors and to wrap the units around the building as they interlock.

A stick system differs in that it requires that the framing and glass are pieced together *in situ*.⁷

The vertical mullions of a glass curtain wall system are defined as structural elements that divide adjacent infill glazing units.⁸ Their purpose in a curtain wall system is to provide a rigid support to the infill glazing of the window. When used to support glazing they are joined with horizontal mullions. Horizontal mullions

⁶ Nik Vigener and Mark Brown, "Building Envelope Design Guide - Curtain Walls," *Whole Building Design Guide: A Program of the National Institute of Building Sciences*, October 20, 2011, http://www.wbdg.org/design/env_fenestration_cw.php.

⁷ Ibid.

⁸ W. Müller and G. Vogel, *Atlante Di Architettura* (Milan: Hoepli, 1992), <http://en.wikipedia.org/wiki/Mullion>.

are also known as transoms; however the term horizontal mullion is more commonly used in practice today.

Sound paths are created both laterally and vertically at the glass curtain wall façade (Figure 2-1). These sound paths radiate acoustic energy inside a building where the vertical and horizontal mullions connect at interior walls and floors. These connection points can reduce the sound isolation performance between spaces, especially where no acoustic treatment has been considered.

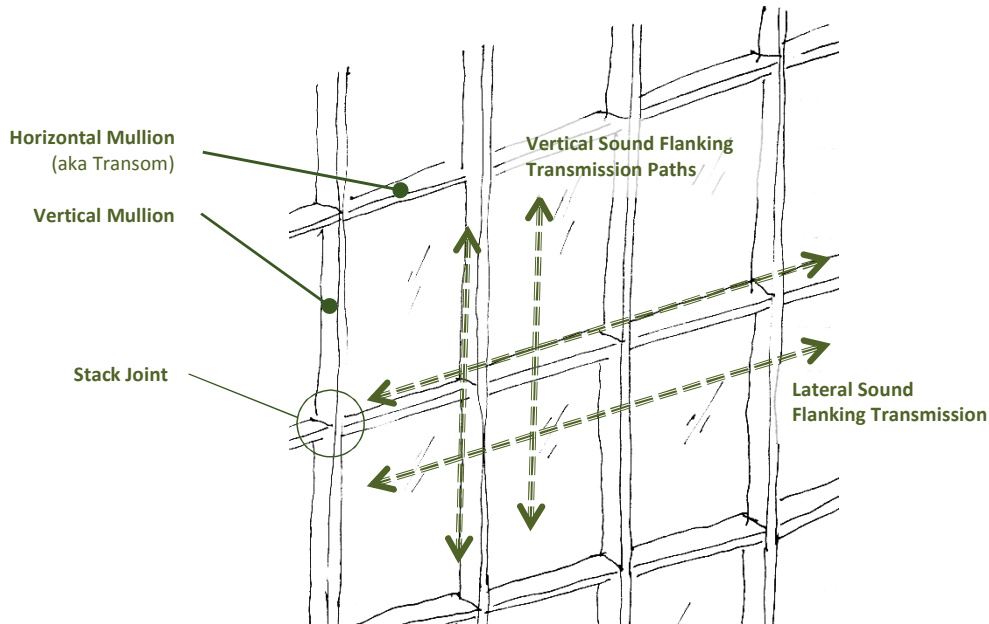

FIGURE 2-1: SOUND TRANSMISSION PATHS ALONG A CURTAIN WALL FACADE

The aluminum mullion extrusions are considered lightweight in acoustic terms when compared to the mass of other materials typically found in a building, such as concrete or steel.

A typical unitized curtain wall mullion section in plan has several points of connection (Figure 2-2). Labels (a) through (d) indicate transitions where the mullion is connected to the glass infill:

- (a) illustrates a mullion connected to the curtain wall glazing, this assembly condition defines the *connected mullion* in the UVM test method;
- (b) the mullion is shown without the glazing;
- (c) identifies connected extrusions components of the unitized aluminum mullion; and
- (d) illustrates the mullion independent from the curtain wall glazing and horizontal mullions, this assembly condition defines the *unconnected mullion* in the UVM test method.

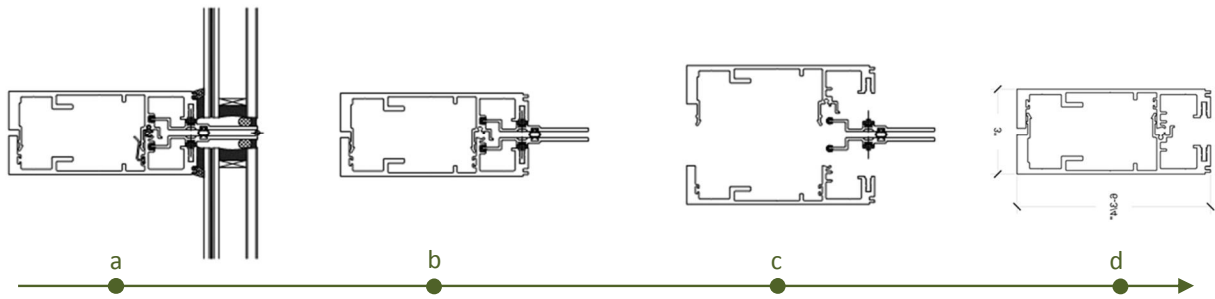

FIGURE 2-2: UNITIZED VERTICAL MULLION EXTRUSION DISASSEMBLED FROM THE GLASS INFILL: THE CONNECTED MULLION (A) AND UNCONNECTED MULLION (D)

The connected and unconnected vertical mullion assembly conditions are critical to understand for application to the laboratory test methodology described in Chapter 3 (Figure 2-2 a and d). The mullion at label (d) illustrates that the air cavity is divided in two by the interstitial “leg” extrusion, which joins at a neoprene gasket (Figure 2-2).

A plastic mockup version of a unitized mullion extrusion identifies two metal anti-buckling clips fastening both sides of the plastic mullion (Figure 2-3). Anti-buckling clips are used at all unitized systems to brace the two halves of the mullion together. These clips are necessary to provide lateral stability of the system and to maintain good weatherability by ensuring a positive pressure on the primary gasket.

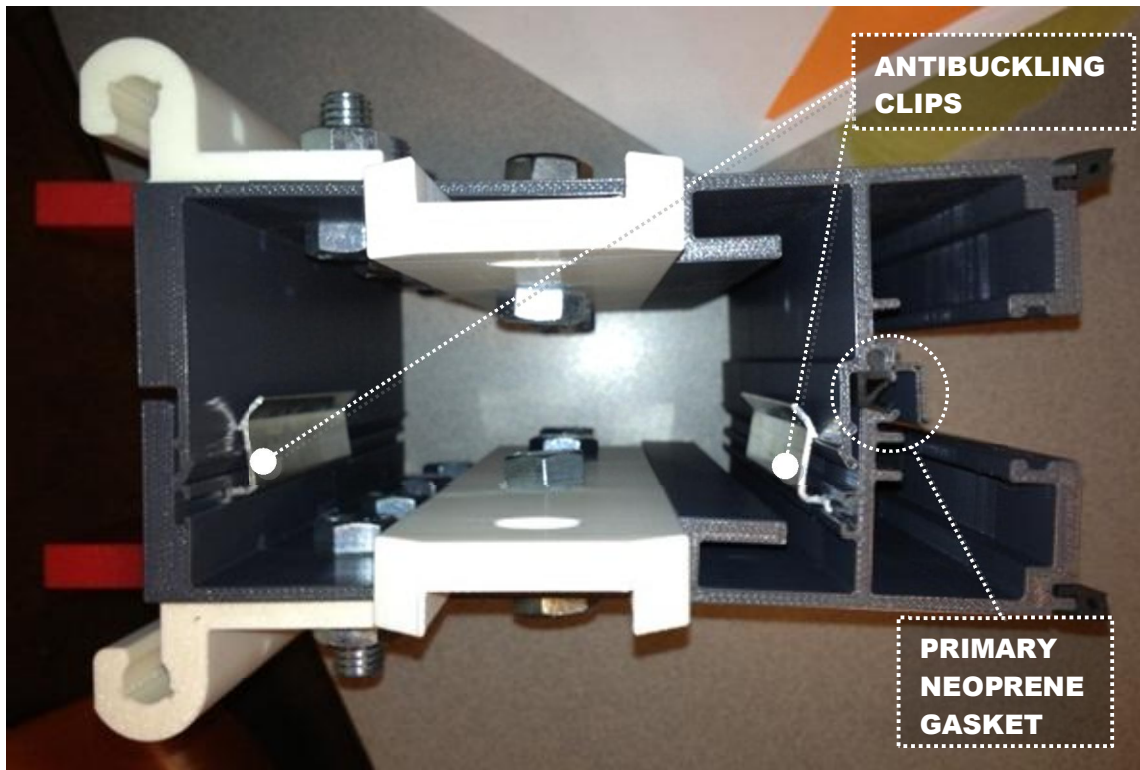

FIGURE 2-3: SECTION OF PLASTIC MULLION MOCKUP WITH ANTI-BUCKLING CLIPS- COURTESY ENCLOS CORP

The clips are typically 2" long, are placed every 24" on center, and adhered in place by silicone dots. Continuous clips may also be employed for other types of curtain wall systems. In the proposed laboratory tests described in Chapter 3, the specimen module used two antibuckling clips at either end of the 5-foot mullion specimen and was adhered by masking tape in the absence of a silicone dot. Images of this can be found in Chapter 4.

The stack joint of a unitized system is located where two vertical mullions intersect with the horizontal mullion. Normally the system is designed so that there is a continuous hollow cavity. The continuous air cavity and frame enables a path for airborne and structure-borne sound to travel.

Due to economic demands and the goal of reducing material costs, unitized curtain wall systems often span double story heights instead of traditional single story heights.⁹ The vertical mullion is therefore continuous between two floors and no stack joint occurs where a horizontal mullion intersects. This potentially means that activities can be heard in a space from floors above or below the receiver floor.

An example of a double-span glass curtain wall system is at the Marriott-Ritz Carleton tower at LA Live, designed by Enclos Corp. Acoustic studies were conducted to evaluate vertical sound flanking. This is discussed as a case study later in this chapter.

2.1.1.1 LOSS DUE TO SOUND FLANKING

The total amount of deterioration in sound blocking due to the junction detail of an interior wall or floor at the glass curtain wall can vary.

Acoustic consultants are familiar with dB loss estimates in the STC values due to sound flanking for typical heavyweight junctions, for example, at a gypsum wall and concrete floor slab. Sources such as British Gypsum¹⁰ publish estimates of 4 – 5 dB loss where normal wall head meets a slab due to poor sealed junction detailing.

Other sources such as from NRC-CNRC indicate up to a 15dB reduction from a continuous subfloor below a partition.¹¹

Laboratory tests were conducted to measure the amount of noise reduction at the curtain wall. These results are provided in Chapter 4.

⁹ Mic Patterson, "Structural Glass Facades," 2011.

¹⁰ British Gypsum, "Education Sector Guide - 7 - Flanking Sound Transmission" (British Gypsum, Saint-Gobain, March 2014), <http://www.british-gypsum.com/~media/Files/British-Gypsum/WHITE-BOOK-Sector-Guides/WBES/WBES-7-Flanking-Sound-Transmission-04.pdf>.

¹¹ A.C.C Wamock, T. R. T. Nightingale, and M.R. Atif, "Estimation of Sound Transmission Class and Impact Insulation Class Rating for Steel Framed Assemblies" (American Iron and Steel Institute / Steel Framing Alliance, 2008).

2.1.1.2 MULLION SOUND PATHS

Chapter 1 introduced the notion that sound can travel horizontally and laterally across a façade via paths through the glass, mullions, and associated connections. There are several additional paths where sound energy may transmit from one side of an internal wall to the other:

- a. **Glazing path** is created when sound energy from the source room strikes the curtain wall glass and transmits the sound energy as vibration to the lightweight mullion and subsequently to the curtain wall glass of the receiver room. The receiver glazing becomes a diaphragm for transmitting the structure-borne sound back into the air (Figure 2-4 Acoustic Key #1). This lateral path is typically not considered in practice for methods of sound mitigation as obviously as the mullions.
- b. **Mullion path** is when the structure-borne sound path is directly transmitted through the vertical lightweight mullion extrusion of the curtain wall system (Figure 2-4 Acoustic Key #2).
- c. **Horizontal mullion path** is the indirect sound transmission through the horizontal mullion (transom) of the curtain wall system (Figure 2-4 Acoustic Key #3).
- d. **Connection path** is the airborne sound path through air gaps/leaks where the mullion connects to the demising partition. (Figure 2-4 Acoustic Key #4).
- e. **Direct wall path** is the structure-borne sound path from direct transmission through the demising partition (Figure 2-4 Acoustic Key #5).

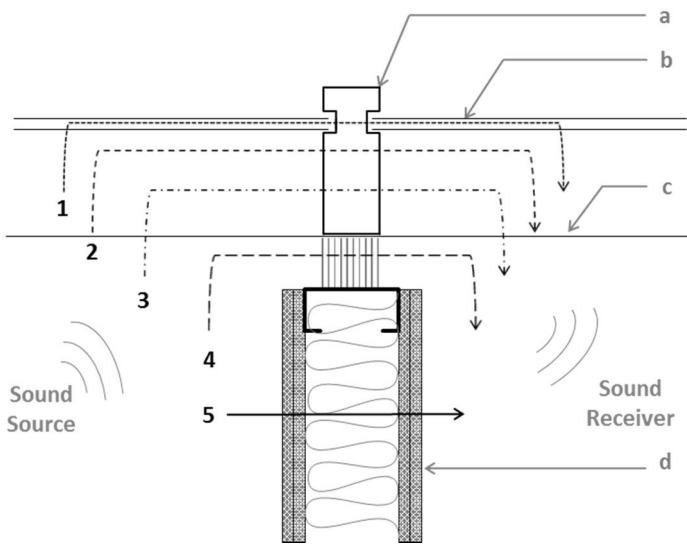

Architectural Key:

- a. Aluminum mullion extrusion
- b. Glass infill of curtain wall framing
- c. Aluminum horizontal mullion of the curtain wall system
- d. Indicative Internal wall partition

Acoustic Key:

1. Flanking sound transmission path across glass -mullion -glass elements
2. Direct sound transmission path through the vertical mullion extrusion
3. Flanking sound transmission path through the horizontal mullion element
4. Flanking sound transmission path at the resilient partition connection
5. Direct sound transmission path across the interior wall partition

FIGURE 2-4: PLAN DIAGRAM OF FIVE INDICATIVE SOUND PATHS AT THE GLASS CURTAIN WALL

2.1.1.3 COMPOSITE TRANSMISSION LOSS PERFORMANCE

Critical to understanding sound flanking transmission at the curtain wall is the significant influence to the composite sound isolation performance.

The interior wall partition has a high sound isolation performance rating (Figure 2-5). This wall construction is typically designed in buildings where high levels of acoustic privacy are required. The wall consists of a double row of steel studs, two layers of gypsum wallboard at both sides, and batt insulation in the air cavity.

The indicative STC rating for this double stud wall is degraded by 10 dB STC points due to the significantly lower performing mullion. This amount of loss is significant because 10dB is perceived by the human ear as twice the level of loudness, the doubling or halving of loudness level.¹²¹³

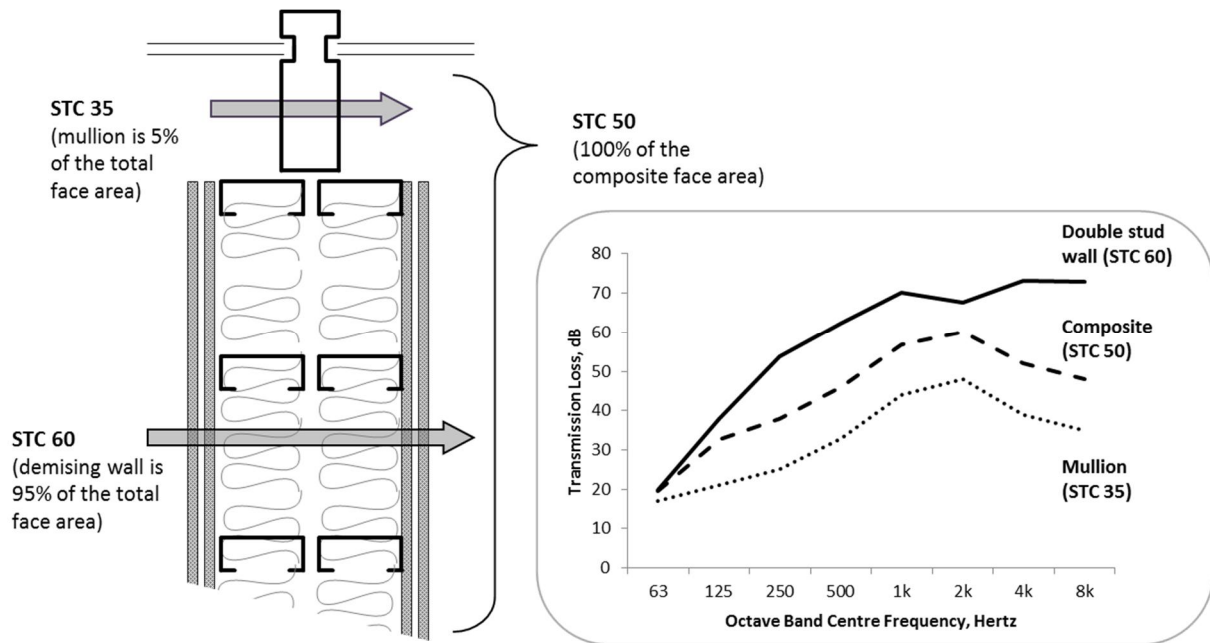

FIGURE 2-5: INDICATIVE DIAGRAMS SHOWING THE COMPOSITE PERFORMANCE BETWEEN A HIGH STC WALL RATING AND LOW STC RATING OF A MULLION.

“Where a [demising] partition has a low isolation value of 35dB or less, flanking transmission is of little consequence, but when partition values of 50 dB are reached, further improvement is limited by the indirect sound paths.”¹⁴ Good architectural detailing for coupling a heavyweight wall with a lightweight mullion opens opportunities to improve acoustic performance ratings and validate the cost of building materials.

Composite TL can be predicted with any element with an individually known STC rating.

¹² Eckard Mommertz, *Acoustics and Sound Insulation: Principles, Planning, Examples* (Birkhäuser, 2009).

¹³ David A. Bies and Colin H. Hansen, *Engineering Noise Control: Theory and Practice* (Spon Press, 2003).

¹⁴ Smith, Peters, and Owen, *Acoustics and Noise Control*, 67.

2.1.1.4 ACOUSTIC BEHAVIOR OF SLITS AND GAPS

Another common reason why sound flanking occurs at the curtain wall system is due to the small air leaks created by slits or gaps from the designed resiliency of the system or common field assembly conditions.

“When the gap size is larger than the wavelength, the wave passes through the gap and does not spread out much on the other side. When the gap size is equal to the wavelength, maximum diffraction occurs and the waves spread out greatly – the wave fronts are almost semicircular.”¹⁵

Slits and gaps generally radiate only high frequency sound. This condition can occur at path #4 shown in Figure 2-4 where the curtain wall mullion connects to the interior wall.

¹⁵ Trevor Cox, “Diffraction through a Single Slit,” *Wave Diffraction*, accessed July 18, 2014, <http://www.acoustics.salford.ac.uk/feschools/waves/diffract3.php>.

2.1.2 MULTIDISCIPLINARY DESIGN PROVISIONS

There are several multidisciplinary considerations driving the design of details for a cohesive curtain wall assemblage. These include resistance and control of fire, air and water infiltration, odor control, thermal resistance, structural strength, durability, and control of sound and vibration¹⁶ (Figure 2-6).

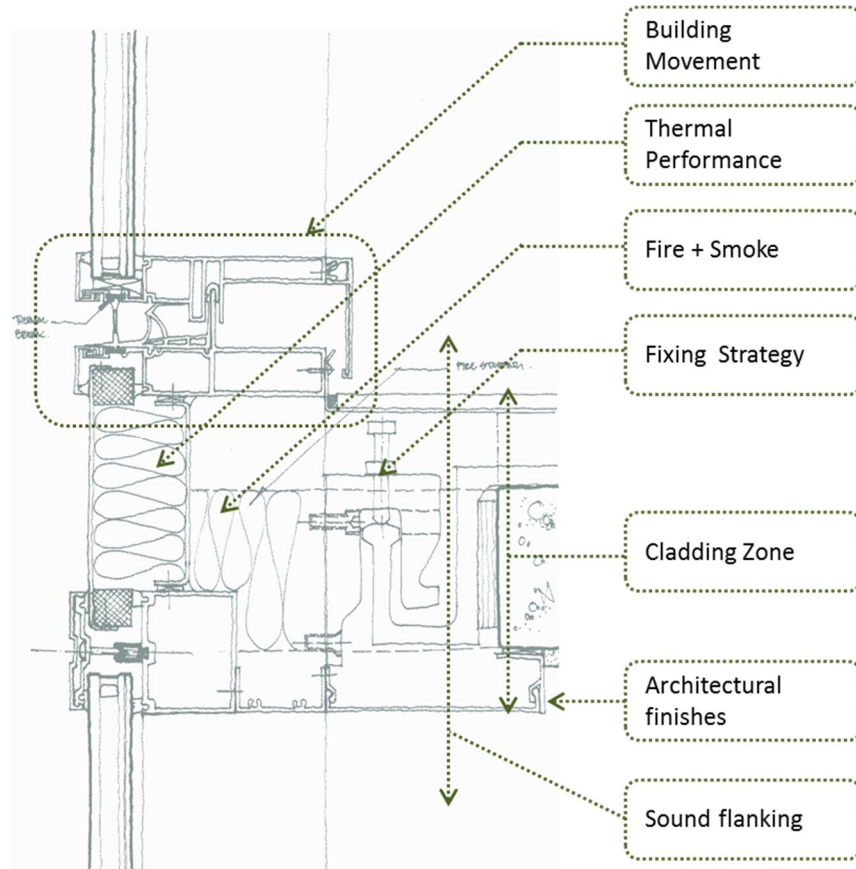

FIGURE 2-6: SECTION THROUGH A CURTAIN WALL TRANSOM WHERE IT IS CONNECTED AT THE STRUCTURAL SLAB. (MULLION SKETCH COURTESY OF MATT WILLIAMS, ARUP FACADES)

The mullion is resiliently fixed to the base building to tolerate façade deflections. Sound flanking paths occur at lightweight and resilient connections at the perimeter of the walls and floors slabs.

There are several challenges associated with modifying the connections to the curtain wall, such as adding mass to the system, maintaining resiliency, insisting on good workmanship, and improving code enforcement. The cross-disciplinary requirements have significant implications on the acoustic performance.

¹⁶ Chris Makepeace et al., *Glass and Metal Curtain Walls: Best Practice Guide Building Technology* (Public Works and Government Services Canada: Canada Mortgage and Housing Corporation, n.d.), <http://www.tboake.com/guides/curtain.pdf>.

1. Adding Mass to the Curtain Wall System

Acoustic Issue

Mass added to building materials generally improves the sound isolation performance. Sound flanking occurs at the edge condition where a slab or wall meets the curtain wall façade because the aluminum extrusions are lighter in mass.

Impact

Adding mass to the curtain wall system will add mass to the overall dead load of the façade and would need to be considered structurally.

2. Maintaining Resiliency at the Curtain Wall System

Acoustic Issue

Airtight seals are not necessarily required on the inboard side between the curtain wall and demising wall and can cause acoustic leaks. Acoustic improvements result from full seals and closure. Modifying/reducing the thermal and structural resiliency afforded in a mullion connection creates a challenge for acoustic improvements.

Impact

Curtain walls require movement to expand and contract as the building heats and cools, wind load conditions, or movements from seismic events. Modifications for acoustics can compromise the resiliency required of the mullion connection.

3. Curtain Wall System Construction Administration

Acoustic Issue

Poor workmanship of curtain wall system constructions may compromise the acoustic detail and degrade overall acoustic performance. The field performance of the acoustics is highly dependent on workmanship. High construction quality must be carefully implemented to avoid short circuiting or bridging of building components.

Impact

Unitized systems (pre-assembled) versus stick systems (field-assembled) can have significant differences between the construction and workmanship of the curtain wall system that can compromise acoustic detailing and overall acoustic performance. Some building construction trades are not typically trained with acoustic material techniques or installation process. Poor construction practice can lead to misplacement of sealants or even gaps between the elements. Field inspections by qualified individuals are necessary to insure good quality construction.

4. Sound Isolation Code Enforcement

Acoustic Issue

Dated legislative code standards and standardized US testing methods should be revisited to clearly enforce specific performances limits relevant to current building technology.

Impact

Many sound isolation regulation requirements in the United States are low compared to some international standards. This limits the impetus for design innovations to improve the acoustic performance of sound flanking (Table 2-5).

2.1.3 ACOUSTIC DETAIL CONSIDERATIONS

The architectural design of the curtain wall system, its connections to the building interior, and required provision for multidisciplinary design all contribute to possible sound flanking paths. The design's details and construction management should take into the consideration the following architectural conditions to reduce sound flanking transmission, as proposed by LoVerde (2008)¹⁷ with respect to primarily to concrete structures:

- Mullions/windows
- Curtain wall connections to the slab
- Floor conditions
- Ceiling (slab) conditions
- Interior intersection details
- Penetrations
- Curtain wall intersection at wall

In a forum discussion amongst acoustic colleagues in the industry, it is noted that detail resolutions at the curtain wall vary and can be challenging:

- Larry Tedford, an Associate Principal at Arup in San Francisco, says, "There is no elegant solution with the expectation of reasonably high acoustic separation performance at curtain wall mullions. Typically an airtight separation with mass and a resilient disconnect is acoustically optimal and aesthetically detrimental. So, the compromise point is what needs to be worked out."¹⁸
- Kym Burgemeister, an Associate Principal at Arup in Melbourne, states that the "detailing of the curtain wall is a challenge, because the façade is a living, breathing building element, that is designed to move and expand/contract as the building heats and cools. Every connection to the façade and mullion needs to be resilient and non-damaging and wrapped around the mullion but not fixed to or through it."¹⁹

No one singular element of the curtain wall design is solely responsible for influencing of sound isolation between two adjacent spaces. The dynamic façade system influences acoustic performance as a composite, although certain elements within the composite may transmit more sound energy than others.

The next section describes design considerations to improve the curtain wall systems.

¹⁷ LoVerde and Dong, "Methods for Reducing Flanking Airborne Noise Transmission through Mullions of Curtain Wall Systems."

¹⁸ Larry Tedford, "Sound Flanking at Curtain Wall Mullions," *Arup Acoustics General Forum: Glazing and Facades*, 2009.

¹⁹ Kym Burgemeister, "Sound Flanking at Curtain Wall Mullions," *Arup Acoustics General Forum: Glazing and Facades*, 2009.

2.2 ACOUSTIC MITIGATION PRACTICES AND PRODUCTS FOR MULLIONS

Methods for improving the sound isolation performance between spaces have been considered by acoustic consultants in the profession and by manufacturers in the industry. This often poses challenges due to the multidisciplinary design provisions associated with the holistic design.

Opportunities for modification are often focused at the vertical mullion. Although this element has a significant contribution to the performance and solutions offered in practice today tend to focus on it, other components at the façade system, for example glass infill and connections, should be examined as well.

2.2.1 PRACTICE-BASED MULLION MODIFICATIONS

Common practice resolutions to reduce sound flanking between adjacent spaces and to improve the acoustic integrity of demising barriers are illustrated in Figure 2-7.

These acoustic concepts, considered by acoustic engineers and architects, are typically categorized by adding mass and/or acoustic damping material in the mullion air cavity or as an overclad, i.e. enclosing the mullion.

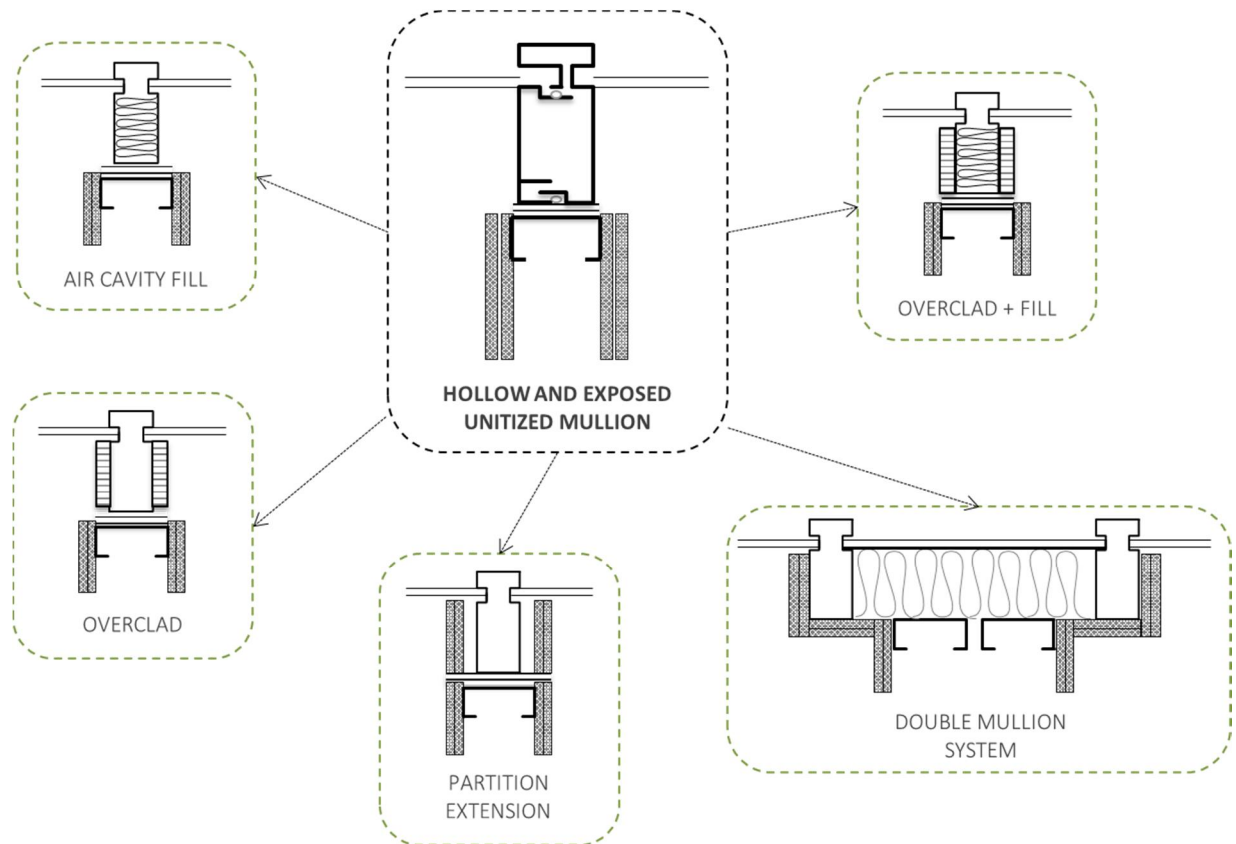

FIGURE 2-7: CATEGORIES OF MULLION DETAIL MODIFICATIONS CONSIDERED TO IMPROVE SOUND ISOLATION

Alternatively, gypsum board wall partitions extend the drywall layers to enclose the mullion. Double mullion systems with a center spandrel panel are used to entirely decouple acoustic paths between spaces. These acoustic details only convey conceptual resolutions and are described in five categories; window wall systems, air cavity fill inside the mullion, mullion overlaid, double mullion and spandrel, and unitized mullion without structural interstitial bridging. The compromise between cost and aesthetic interventions with the amount of acoustic benefits also needs to be considered.

Window Wall Systems

Extending internal walls and floors to penetrate through the façade diaphragm is the most effective way of reducing sound flanking transmission. This system is typically called a 'window wall' instead of a curtain wall. The vibrational sound energy transmitting through the glazing and lightweight mullion path terminates at the internal wall partition and does not pass through to the adjacent space. However, penetrating the exterior glazing at these demising walls has significant architectural design implications.

Air Cavity Fill within the Mullion Cavity

Packing the hollow metal cavity of the mullion extrusion can add mass and damping to the element and therefore improves the sound isolating performance. Materials seen in practice are cement board or steel plate lining glued inside and gravel, sand or fiberglass fill. This is more often implemented in European countries than in the U.S. Damping materials such as vinyl sheets are also an option to reduce structure borne vibration. Other solutions involve "insulating the mullions by filling them with expanding foam, sand, non-shrinking mortar, caulk or lightweight cement."²⁰

Mullion Overlaid

Encasing the mullions and sills both vertically and horizontally with layers of gypsum wallboard or sheathing will improve the sound isolation of the lightweight mullion construction because mass and damping are added. This modification to the mullion limits the sound across the mullion path, but only addresses one of many paths for sound to travel.

In practice, mullion overlaid can be a challenge to enforce *in situ* for the following reasons:

1. In the event that the demising partition is relocated (for example, in a retrofit), the overlaid attachment (screwed) or adherence (glued) will deface the mullion.
2. When MechoShades[®] (or similar product) are integrated as part of the architectural design, the fitted dimension can be compromised.
3. Gypsum board cladding may not allow sufficient mullion deflection movement for certain installations. Curtain wall mullions require allowable deflection movement $\pm 1"$ toward and/or away from the building at mid-span. This is dependent on the structural requirements custom to each project.)

Double Mullion and Spandrel

Using a double mullion plus spandrel where walls and floors meet will reduce the sound flanking transmission because this decouples the sound transmission paths. The double mullion arrangement

²⁰ Dave Barista, "Glass Curtain Wall: Plenty of Light, but Is It Soundtight?," *Building Design + Construction*, May 2, 2006, http://www.bdcnetwork.com/glass-curtain-wall-plenty-light-it-soundtight?page=1&quicktabs_1=1.

allows a resilient disconnection between the mullions, but would need to be carefully detailed for relevant design disciplines.

Unitized Mullion without Structural Interstitial Bridging

Isolating each structural member or “splitting” the mullion is a very effective way of reducing the sound flanking path, but has to be carefully detailed for acoustic, structural, moisture and thermal integrity. Assuming a design where the mullions running vertically and horizontally are seamless, this solution will break the continuity requiring elements to be tied back to the structure separately.

Even when acoustic concept details are properly specified for a building, acoustic performance can still be limited because installation is contingent on workmanship. Construction quality must be carefully implemented to avoid acoustically short circuiting, i.e. mechanical bridging of building components. Many building construction trades people are not trained properly with regard to acoustic material techniques or installation processes.

2.2.2 PRODUCT-BASED MULLION MODIFICATION

Sound flanking transmission at the curtain wall is becoming a known issue in the industry, and some manufacturers are patenting designs that aim to improve sound insulation performance between spaces. This includes techniques such as the use of isolation clips, infill materials, and others (Table 2-1).

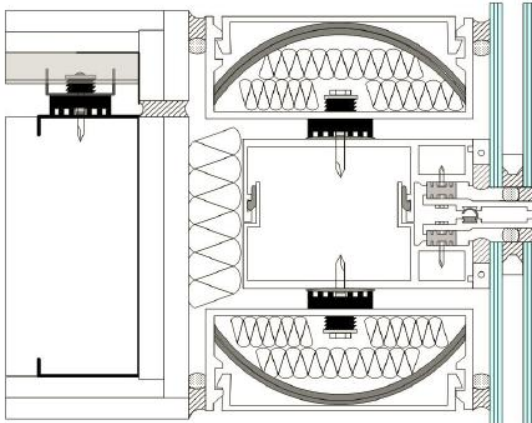
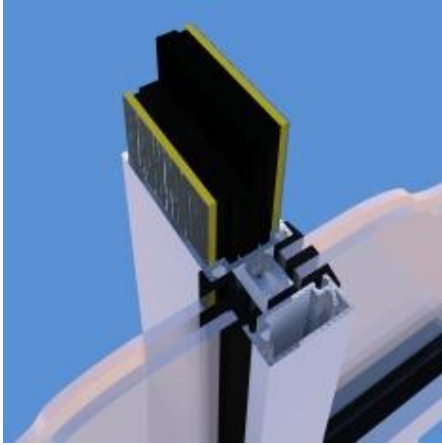
No.	Product	Description
1	 <p data-bbox="276 955 820 1039"><i>Image from ©2012 PAC International, Inc. RSIC®-AMI window mullion</i></p>	<p data-bbox="901 567 1429 745">This is a US based proprietary product called Resilient Sound Isolation Clip. It is a neoprene button that decouples both sides of the curtain wall mullion from the aluminum tube overclad.</p> <p data-bbox="901 766 1429 871">The figure shows that the overclad is filled with an MLV (mass limp vinyl) interlayer and fiberglass insulation.</p> <p data-bbox="901 892 1429 955">The composite performance per ©PAC International, Inc. achieves STC 58.</p>
2	 <p data-bbox="276 1501 820 1579"><i>Image from © Siderise Mullion / Transom Acoustic Inserts</i></p>	<p data-bbox="901 1155 1429 1333">Siderise Mullion & Transom Inserts is a UK based product. The mullion is filled with a proprietary infill material to reduce the vertical and horizontal sound transmission between adjacent spaces.</p> <p data-bbox="901 1354 1429 1459">The performance per © Siderise is “up to 41 dB R_w ‘through’ frame on a 50mm mullion.”</p>

No.	Product	Description
-----	---------	-------------

3



Image from © Siderise Acoustic Barrier Overlay

The Siderise Acoustic Barrier Overlay® is a UK based product. It consists of a flexible composite mass overlay to improve floor to floor sound isolation.

4



Image from © Siderise Acoustic Void Barrier

The Siderise Acoustic Void Barrier® is a UK based product.

The performance of the void barrier can achieve over 51dB R_w per the manufacturer.

5

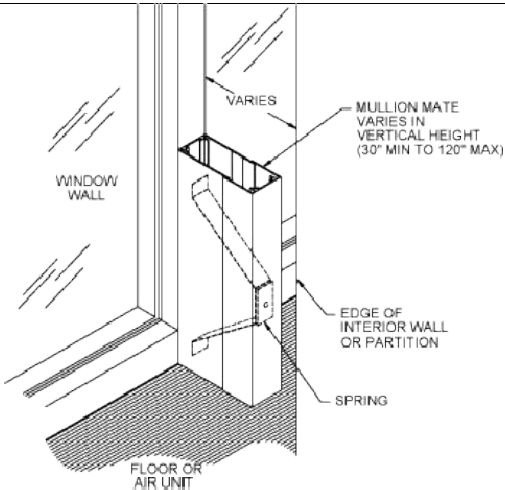

Image from © 2011 Gordon Incorporated, Mullion Mate

Mullion mate® is a product by Gordon Interior Specialties Division in the US. Its main function is to close the gap between a window mullion and partition wall with a spring loaded device that snaps into place.

© Gordon Incorporated indicates an attenuation performance of STC 38.

No.	Product	Description
6		<p>The Mull-It-Over Trim Cap is panel that is capped to either side of a curtain wall mullion. The panel leaf consists of a composite of aluminum, foam, and a damping interlayer.</p> <p>The mullion performance per © Mull-It-Over is an increase to STC 57.</p>
7		<p>The Partition Closure Seal® is a US product. It is a silicone face seal joint that provides a closure between glass or mullion and an interior wall.</p>
8		<p>EMSEAL® is a US based product consisting of a mass-loaded acoustic seal that it used to close the end of a partition to a glass window or mullion.</p> <p>The performance per © EMSEAL is STC 53 with one seal layer and STC 72 with two layers.</p>

Image from ©2014 Mull It Over Trim Cap

Image from Michael Rizza Company™, A Division of Balco Inc. PCS Partiton Closure Seal © 2014 Arcat, Inc.

Image from © 1998-2015 by EMSEAL Joint Systems, Ltd.

TABLE 2-1: MULLION PRODUCTS TO REDUCE SOUND FLANKING TRANSMISSION AT THE CURTAIN WALL

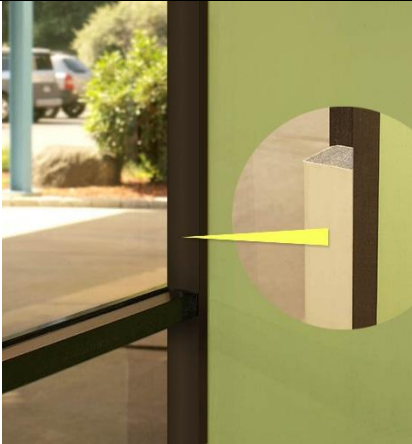
These products provide a mullion overclad, mullion infill, or mullion connection option to increase mass and improve resilience of the mullion, but they do not address the flanking transmission across the glass or necessarily at building connection components. Most of the acoustically tested products do not necessarily include the glass infill in the test procedure.

Additionally, most of these products also require drilling holes to attach the product to the mullion. This can be problematic especially if the partition is relocated or the building is repurposed.

In the proposed laboratory measurement procedure described in Chapter 3, three of the products described here will be tested within the following phases:

- Phase 2A: Partition Closure Seal®
- Phase 2B: Mull-it-Over® and Mullion Mate®

2.2.3 SUMMARY OF PRACTICE AND PRODUCT SOLUTIONS

Resolutions to improve the sound insulation performance of the mullion have been attempted by custom engineered design methods or by proprietary products. However, both methods often have significant impacts on the curtain wall systems design and construction including that they are

- Usually not being cost effective,
- Not aesthetically pleasing,
- May not be part of the owner's project requirements and criteria,
- Not practical to construct,
- Dependent on contractor's ability to build it,
- Not as acoustically effective as they should be,
- Not able to resolve the flanking path through the glass.

2.3 SOUND ISOLATION METRICS AND MEASUREMENT METHODS

The performance due to sound flanking transmission is obtained with laboratory or field test measurement for sound isolation. The US and Canada use test procedures based on ASTM standards and Europe, the UK, Australasia and other parts of the world are based on ISO standards. Background information for both standards will be referenced in this section.

Although the method for measuring and calculating the sound isolation performance of building elements is generally similar, the results can significantly vary based on the applied acoustic indices. The ASTM E90 standard for Sound Transmission Loss measurements in an acoustic laboratory will be used in the test methodology proposed in Chapter 3.

The following section describes ASTM standardized test methods, rating procedures, and broad relevant comparisons to ISO standards. A higher single number value indicates a higher sound isolating performance of a specimen.

2.3.1 ASTM STANDARD TEST METHODS AND RATING PROCEDURES

The common laboratory test procedure for sound isolation in the US is defined by the ASTM E90-09 standard called “Standard Method for Laboratory Measurement of Airborne Sound Transmission Loss of Building Partitions”²¹. Sound isolation performance is tested between two reverberant chambers in an acoustic laboratory where a sound source is emitted in the source chamber and measured in the adjacent receiving chamber. The difference between the sound emitted and sound received provides the overall sound transmission loss (TL) at one-third octave band center frequencies. The frequency range is defined from 125 Hz to 4000 Hz in this standard. Equation used to calculate **Transmission Loss (TL)** is shown below:

$$TL = (L_1 - L_2) + 10 \log\left(\frac{S}{A}\right), dB \quad \text{EQUATION 2-1}^{22}$$

Where

L_1 is the average sound pressure level in the source room, dB

L_2 is average sound pressure level in the receiving room, dB

S is the surface area of the partition (ft²)

A is the absorption in sabins in the receiving room.

The term $10 \log\left(\frac{S}{A}\right) \cdot dB$ is the normalizing factor. This needs to be adjusted or normalized so that the Transmission Loss values from different testing laboratories may be compared. It is used to adjust for the different size of test specimens tested in each laboratory and the amount of sabin absorption in each receiving room.

²¹ E33 Committee, *ASTM E90 - 09 Test Method for Laboratory Measurement of Airborne Sound Transmission Loss of Building Partitions and Elements* (ASTM International, 2009), <http://www.astm.org/Standards/E90.htm>.

²² E33 Committee, “ASTM E90 - 09 Test Method for Laboratory Measurement of Airborne Sound Transmission Loss of Building Partitions and Elements” (ASTM International, 2009), 90, <http://www.astm.org/Standards/E90.htm>.

A single-figure numerical rating may be classified from the laboratory transmission loss called sound transmission class (STC). The STC classification is based on the ASTM 413 standard and is one of the most common indices used in the US to rate the sound isolation performance of all types of architectural barriers (e.g. walls, floors, doors, windows).²³ This rating is only assigned to laboratory tested specimens.

It is possible that two different barrier assemblies perform with identical STC ratings, but may have significantly divergent frequency regimes. Therefore the TL per octave band frequency is currently the best way to understand the acoustic characteristics of a barrier than solely relying on the single figure STC rating.

The STC rating is derived by weighing a reference contour based on the ASTM E413 standard to the laboratory (standard noise reduction curve) measured one-third octave band TL values. The standard was created to provide a single number rating for interior building partitions that are subjected to noises from speech, television, radio, office equipment, and other mid to high frequency noise sources²⁴.

An example of a STC reference contour adjustment to a TL performance is shown in FIGURE 2-8. The final STC rating of the given test specimen is defined where the value at 500 Hz intersects at the defined reference contour, in this example the TL is 32 dB at 500Hz, thus the specimen is rated STC 32.

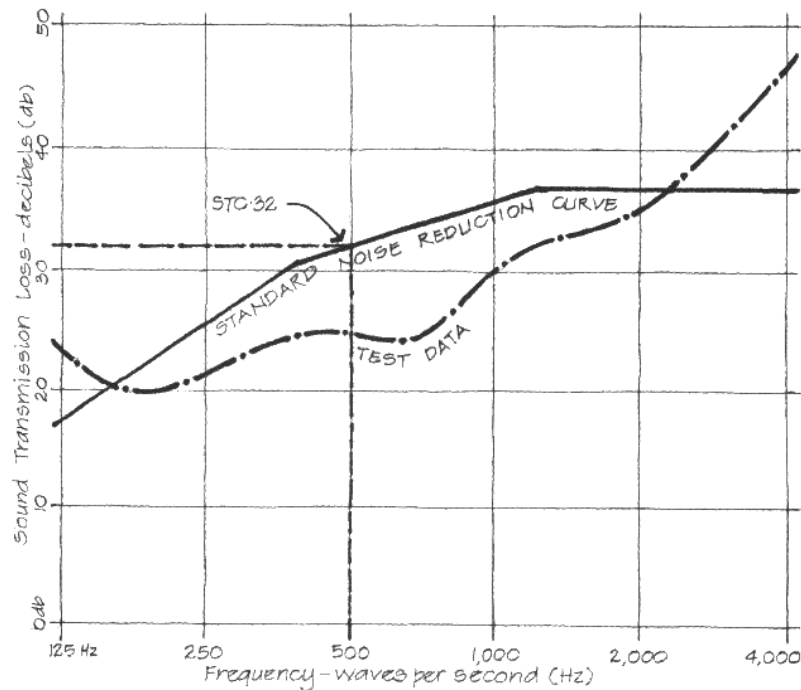

FIGURE 2-8: STC REFERENCE CONTOUR AGAINST THE TRANSMISSION LOSS OF A TESTED SPECIMEN²⁵

²³ E33 Committee, *ASTM E413 -10 Classification for Rating Sound Insulation* (ASTM International, 2010), <http://www.astm.org/Standards/E413.htm>.

²⁴ Architectural Testing, "Architectural Testing - Acoustical Performance Testing", n.d., <http://www.archtest.com/testing>.

²⁵ James E. Ambrose and Jeffrey Ollswang, *Simplified Design for Building Sound Control* (John Wiley & Sons, 1995).

The acoustic index that corresponds with a sound transmission measurement tested in the field is called the field sound transmission class (FSTC). FSTC ratings can typically range 5– 10 dB less than the STC rating for the same specimen. This is because building specimens tested in the laboratory are devoid of sound flanking paths that reduce the achievable acoustic performance. The standardized procedure to measure the transmission loss of a building element in the field is defined by ASTM E336²⁶ and rated per ASTM E413.

Noise Isolation Class (NIC) is another valuable rating used to classify the sound isolation performance of building specimens in the field. The rating is derived from Noise Reduction (NR) performance at one-third octave band center frequencies. The NR is simply the arithmetic difference between the sound pressure levels in the source and receiving rooms.

$$\Delta NR = (L_1 - L_2)$$

Where

L_1 is the average sound pressure level in the source room, dB

L_2 is average sound pressure level in the receiving room, dB

EQUATION 2-2²⁷

Similar to the STC rating procedure, the single-figure NIC rating can be defined from NR values by comparing the measured data to the standard reference contour per the ASTM E413 standard. The NIC rating cannot be used in place of FSTC since it is only specific to the context in which it was measured: the partition type, partition area, and amount of absorption present in the receiving room at the time of the measurement²⁸.

The NIC rating is different that the ASTM procedure for STC and FSTC because “no correction to the measured [NR] data is made to account for partition size, receiving room absorption or sound flanking. There are no widely used standards using the NIC rating, however the NIC rating is often used *in lieu* of STC and FSTC ratings. NIC is used to assess the sound isolation performance of *in situ* partition constructions, especially complicated ones that involve multiple sound transmission paths that are not suited for laboratory testing.”²⁹

The ASTM standards corresponding to the sound isolation test rating are AST E90, ASM E336, and ASTM E413.³⁰

- **ASTM E90** provides the measurement procedure to obtain transmission loss (TL) per one-third octave band frequencies in an acoustic laboratory.
- **ASTM E336** provides the measurement procedure to obtain noise reduction (NR) and field transmission loss (FTL) per one-third octave band frequencies in the field.
- **ASTM E413** provides the classification procedure to define the single number rating for sound transmission class (STC), field sound transmission class (FSTC), and noise isolation class (NIC).

²⁶ E33 Committee, “ASTM E336 - 11 Standard Test Method for Measurement of Airborne Sound Attenuation between Rooms in Buildings” (ASTM International, 2011), <http://www.astm.org/Standards/E336.htm>.

²⁷ Ibid., 33.

²⁸ Marshall Long, *Architectural Acoustics* (Elsevier, 2006).

²⁹ Malcolm J. Crocker, *Handbook of Acoustics* (John Wiley & Sons, 1998).

³⁰ E33 Committee, “ASTM E413 -10 Classification for Rating Sound Insulation” (ASTM International, 2010), 413, <http://www.astm.org/Standards/E413.htm>.

2.3.2 ISO STANDARD TEST METHODS AND RATING PROCEDURES

The ISO standards for sound isolation measurements range from 100- 3150 Hz. This differs slightly from the ASTM standards that range from 125 – 4000 Hz. There are many ISO standards for testing the sound isolation performance of specimens with and without flanking for various surface areas and beyond the scope of this work. However relevant corresponding ISO indices that may be used as a comparison to the ASTM standards are described in this section to inform case study comparisons later in this chapter.

The ISO single figure index R_w is approximately comparable to the ASTM value STC. Similarly, the single figure number D_w is comparable to the ASTM value NIC. The final value of the comparable ISO and ASTM indices will vary slightly. General equivalent performance descriptions between standards are summarized from ASTM E90, ASTM E339, ASTM E413, ISO 10848, ISO EN 12354 and ISO EN 140 (Table 2-2).

ASTM ¹ Index	ISO ² Index	Measurement Type	Value (dB)	Description
TL	R	Laboratory (one-third octave)	$TL = L_1 - L_2 + 10 \log (S/A_2)$ $R = L_1 - L_2 + 10 \log (S/A_2)$	[TL] Transmission Loss [R] Sound Reduction Index
STC	R_w	Laboratory (single figure)	Classified per TL (ASTM) or R (ISO)	[STC] Sound Isolation Class [R_w] Weighted Sound Reduction Index
NR	D	Field (one-third octave)	$NR = L_1 - L_2$ $D = L_1 - L_2$	[NR] Noise Reduction [D] Level Difference
NIC	D_w	Field (single figure)	Classified per NR (ASTM) or D (ISO)	[NIC] Noise Isolation Class [D_w] Weighted Level Difference
--	D_n	Field (one-third octave)	$D_n = D - 10 \log (A/A_0)$	[D_n] Normalized Level Difference
NNR	D_{nT}	Field (one-third octave)	$NNR = L_1 - L_2 + 10 \log (T/T_0)$ $D_{nT} = L_1 - L_2 + 10 \log (T/T_0)$	[NNR] Normalized Noise Reduction [D_{nT}] Standardized Level Difference
NNIC	D_{nTw}	Field (single figure)	NIC $D_{nTw} = D + 10 \log (T/T_0)$	[NNIC] Normalized Noise Isolation Class [D_{nTw}] Weighted Standardized Level Difference

TABLE 2-2: CORRELATION BETWEEN ASTM AND ISO SOUND ISOLATION INDICES

¹ The Transmission Loss frequency range in the ISO standard is from 100 – 3150 Hz.

² The Transmission Loss frequency range in the ASTM standards is from 125 – 4000Hz.

Legend:

- S** Testing area of the specimen (ft², m²)
- A** equivalent absorption area (ft², m²)
- A₀** reference absorption area (10m²)
- T** Reverberation Time (seconds)
- T₀** Reverberation Time (0.5 seconds)
- V** Volume of receiving room (ft³, m³)
- L₁** Average sound pressure level in the source room (dB)

L₂ Average sound pressure level in the receiving room (dB)

Sound isolation indices may be characterized as normalized, standardized, or weighted. This is a function of the measurement conditions including sound flanking, room volumes, and sound absorption. The indices are defined below:

- **Weighted:** to establish a single figure rating descriptor, normalized or standardized levels are compared to the Reference Curves published in BS EN ISO 717 or ASTM 413 for airborne noise transmission.
- **Normalized:** adding the Sabine equation ($10 \log (S/A)$) (metric) to the receiving room so that room to room variation in the field will not influence the results. This is due to the variation of sound absorbing materials encountered in the field.
- **Standardized:** standardizing the sound pressure levels to a reverberation time of $T = 0.5$ sec is equivalent to standardizing the equivalent area absorption of $A_0 = 0.32$ V (metric) if the reverberation times differ.

There are many relevant ISO standards that are currently used to predict and test flanking sound transmission (Table 2-3).

International Organization for Standardization

ISO 140-1	Acoustics -- Measurement of sound insulation in buildings and of building elements -- Part 1: Requirements for laboratory test facilities with suppressed flanking transmission
ISO 140-2	Acoustics -- Measurement of sound insulation in buildings and of building elements -- Part 2: Determination, verification and application of precision data
ISO 140-3	Acoustics -- Measurement of sound insulation in buildings and of building elements -- Part 3: Laboratory measurements of airborne sound insulation of building elements
ISO 140-4	Acoustics -- Measurement of sound insulation in buildings and of building elements -- Part 4: Field measurements of airborne sound insulation between rooms
ISO 140-5	Acoustics -- Measurement of sound insulation in buildings and of building elements -- Part 5: Field measurements of airborne sound insulation of façade elements and façades
ISO 10848-1	Acoustics; Laboratory measurement of the flanking transmission of airborne and impact sound between adjoining rooms - Part 1: Frame Document
ISO 10848-2	Acoustics; Laboratory measurement of the flanking transmission of airborne and impact sound between adjoining rooms - Part 2: Application to light elements when the junction has a small influence
ISO 10848-3	Acoustics -- Laboratory measurement of the flanking transmission of airborne and impact sound between adjoining rooms -- Part 3: Application to light elements when the junction has a substantial influence
ISO 10848-4	Acoustics -- Laboratory measurement of the flanking transmission of airborne and impact sound between adjoining rooms -- Part 4: Application to junctions with at least one heavy element
ISO 717-1: A1:2006	Acoustics; Rating of sound insulation in building and of building elements - Part 1: Airborne sound insulation.

International Organization for Standardization

ISO 12354-1 Building Acoustics – Estimation of acoustic performance of building from the performance of elements – Part 1: Airborne sound insulation between rooms

TABLE 2-3: INTERNATIONAL STANDARDS FOR SOUND ISOLATION AND FLANKING TRANSMISSION

There are several relevant ASTM standards that address sound isolation and measure flanking sound transmission (Table 2-4).

American Society for Testing and Materials

ASTM E90	Test Method for Laboratory Measurement of Airborne Sound Transmission Loss of Building Partitions and Elements
ASTM E336 Annex A1 and Annex A2	Standard Test Method for Measurement of Airborne Sound Attenuation between Rooms in Buildings
ASTM E413	Classification for Rating Sound Insulation

TABLE 2-4: AMERICAN STANDARDS FOR SOUND ISOLATION AND FLANKING TRANSMISSION

The ISO 12354 standard provides a prediction methodology for sound flanking transmission. Four paths identified in the standard used for analytical calculation are defined (FIGURE 2-9). Designations for the flanking paths and separating elements are identified between the source and receiving chambers. The F is designated for the flanking element and D for a separating element in the source room and f and d for respective flanking and separating elements at the receiving room.

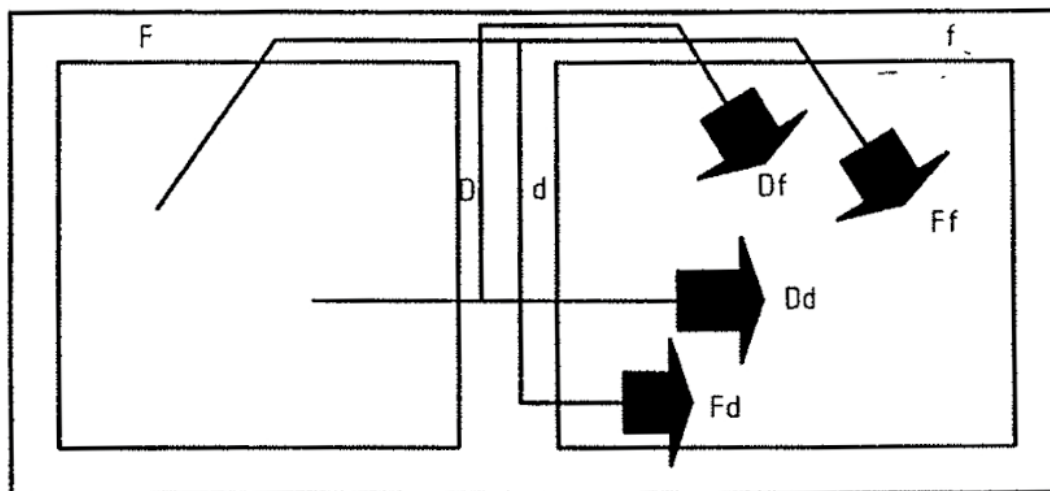

FIGURE 2-9: DEFINITION OF SOUND TRANSMISSION PATHS BETWEEN ROOMS PER ISO 12354 (IMAGE: ISO 12354)

There are currently no ASTM standards for prediction methodologies.

³¹ ISO 12354-1:2000 Building Acoustics. Estimation of Acoustic Performance in Buildings from the Performance of Elements. Airborne Sound Insulation between Rooms (BSI, July 15, 2000).

2.3.3 SOUND ISOLATION CRITERIA

The minimum sound isolation criteria regulated by building legislation varies between countries, both in performance and acoustic index, i.e. ASTM and ISO. A summary of select international building legislation primarily for residential building code is normalized to the same acoustic metric, sound transmission class (STC) (Antonio, 2008) (Table 2-5). This is an indicator of what building code dictates as the absolute minimum performance that can be built to meet acoustic privacy needs for health, safety, and disturbance.

STC	Building Legislation
69	¹ Draft Nordic Standard ‘very good sound conditions’
65	² German Standard (Highest Class Acoustical Comfort)
64	¹ Draft Nordic Standard ‘satisfactory sound conditions’
61	¹ Draft Nordic Standard ‘acceptable sound conditions’
61	³ UK ‘Quiet Homes’ minimum recommendation
60	⁴ Minimum Australian requirement: Bathrooms and Kitchens to habitable rooms
59	² Minimum German Standard ‘lowest class acoustical comfort’
56	⁵ Minimum UK requirement
55	¹ Draft Nordic Standard ‘less satisfactory sound conditions’
55	⁴ Minimum Australian requirement: Sole occupancy units
50	⁶ Minimum 2013 California Building Code (CBC), Residential
40	⁶ Minimum 2013 California Building Code (CBC), Non-residential

Note: The STC comparisons include assumptions and broad estimates of equivalence between different acoustic indices. Accordingly, the table should not be used as an absolute justification of criteria, but an indicator of approximate comparisons.³²

1. Draft Nordic Standard INSTA 122:1997 Sound Classification of Buildings
2. German Standard DIN 4109: Sound Insulation in Buildings
3. Quiet Homes: a guide to good practice and reducing the risk of poor sound insulation between dwellings, Building Research Establishment
4. City of Sydney DCP, 1996
5. Building Regulations, Approved Document E, 2002
6. Minimum requirement 2013 California Building Code Section 1208

TABLE 2-5: APPROXIMATE COMPARISON OF SOUND ISOLATION CRITERIA FOR INTERNATIONAL RESIDENTIAL BUILDING CODE, STC

Sound isolation regulation requirements of the United States have not been developed to the same extent as the international standards. This is due to the history of the federal noise legislation in the United

³² Nick Antonio, “Residential Sound Insulation and Building Code” (Acoustic Society of America, LA Chapter Meeting, Los Angeles, January 15, 2008).

States. After federal noise regulation responsibilities transferred from national to state and local governments, further research in building acoustics (e.g. sound flanking transmission) was curtailed.

Congress ended funding of the federal noise control program ONAC (Office of Noise Abatement and Control) in 1981. The ONAC was originally established by the EPA (Environmental Protection Agency). Before funding ended, the EPA established regulations and programs which were salient to the development of many state and local government noise control laws across the United States³³. However, after ONAC closed, the responsibility of noise and abatement was transferred to State and local governments, which truncated the development of further national regulations.

It is assumed that this may be an indication of the status of United States building research in acoustics trailing those of other countries. For example, there are no testing standards or acoustic laboratories in the United States which test sound flanking conditions like the Building Research Establishment in the UK³⁴, the NRC-IRC Flanking Sound Transmission Facility in Canada³⁵ or the Sound Flanking Transmission Lab at the ift Rosenheim³⁶ in Germany.

In the United States, the EPA retains authority to conduct research and publish information on noise and its effects on the public³⁷.

Since building science research can often be driven by regulations, this is potentially why sound isolation is at a minimum in certain state jurisdictions. The California Building Code (CBC) requirements are lower than most international standards. CBC requires a minimum STC 40 interior sound transmission performance between separating non-residential spaces and STC 50 at separating residential spaces.³⁸

Design incentives to improve the sound isolation performance in the USA may be limited because an increase in code requirements can translate to added cost of construction.

The American measurement standard, which includes sound flanking transmission, is ASTM E336, but this standard does not necessarily target the sound flanking weaknesses and instead is aimed at an overall composite demising assembly performance. In the context of a demising wall joined at a curtain wall, it would be difficult to extract the specific transmission loss contributions from the curtain wall.

Although ISO Standards have both a calculation prediction method (ISO 12354-1) and a testing method (ISO 140-4) specific to sound flanking transmission, they do not apply to lightweight elements like a curtain wall mullion. The computation developed in the ISO EN 12354 methodology for the apparent sound insulation of building assemblies is for wall and floor elements that are assumed to be heavy, monolithic, homogeneous and moderately damped³⁹.

³³ US EPA, "Noise Pollution | Air and Radiation | US EPA", 1981, <http://www.epa.gov/air/noise.html>.

³⁴ "BRE Group: Acoustics Laboratory", n.d., <http://www.bre.co.uk/page.jsp?id=1146>.

³⁵ F. King T. Estabrooks, "NRC-IRC Flanking Sound Transmission Facility," *National Research Council Canada*, no. NRCC-51390 (October 2009): 3.

³⁶ ift Rosenheim, "Laboratory Building Acoustics," accessed May 14, 2015, <https://www.ift-rosenheim.de/en/labor-bauakustik>.

³⁷ US EPA, "Noise Pollution | Air and Radiation | US EPA."

³⁸ *2013 California Green Building Standards Code California Code of Regulations, Title 24, Part 11 (CALGreen)* (International Code Council, ICC, 2013).

³⁹ T. R. T. Nightingale, "On Using Multiple Kij's in the EN12354 Acoustics Prediction Model to Represent Excess Attenuation in Flanking Surfaces" (presented at the Proceedings of the 17th International Congress on Acoustics, Rome, Italy, 2001).

The standardization of prediction and measurement methodologies of sound flanking transmission at glass curtain wall remains under development for both ASTM and ISO standards.

Another consideration that standardized tests do not take into account is the potential room modes that can be excited due to the location of the vertical mullion element at the corner of the room. A corner location can amplify the sound level in the receiving room by exciting modes, emulating how a loudspeaker at the corner of a room can provide this acoustic excitation. This acoustic effect should be noted but is generally assimilated with the overall sound isolation rating.

The modal theory of sound indicates that by “aiming the loudspeaker into a corner of the room (especially in smaller rooms), all resonant modes are excited, because all modes terminate in the corners.”⁴⁰ Modes can excite and amplify frequencies based on room dimension and room shape. The aluminum mullion, sill, and transom of a curtain wall are located at the corners of the room and sound that leaks through these elements may be amplified based on their corner location in a room.

⁴⁰ F. Alton Everest and Ken C. Pohlmann, *Master Handbook of Acoustics* (McGraw-Hill Professional, 2009).

2.4 ACOUSTIC PRECEDENT RESEARCH STUDIES

The following section describes academic and professional entities that have conducted research and development in the field of sound flanking transmission relevant to facades.

Acoustic test laboratories that investigate façade sound isolation for acoustic consulting or design fabrication are also identified, including test methods to evaluate lightweight building elements.

Although outside the scope of this research study, models for predicting sound flanking mechanism are described based on the ISO 12354-1 method. These research studies conducted by others on predictive models inform methods to compare physical experiment transmission loss (or sound reduction) data.

In addition, physical testing case studies specific to glass curtain wall elements are described. These test experiments conducted by others inform the development of the UVM test procedure described in Chapter 3.

2.4.1 LABORATORY ENTITIES AND INVESTIGATIONS OF FAÇADE SOUND ISOLATION

A proposal for a sound flanking laboratory to conduct research on lightweight construction was published as early as 1974 by Nagy at the Technical University in Budapest.⁴¹ The intent of the laboratory was for students to conduct simultaneous airborne sound reduction measurements within a multi-room room facility, which included decoupled volumes to measure curtain wall sound flanking transmission. At this time, very few multi-chamber laboratories existed, except for those that investigated sound flanking transmission across ceiling plenums. The research conducted by Nagy confirmed the complexity of paths influencing sound flanking sound transmission for lightweight versus heavy weight specimens and the variation of responses dependent upon partition quality.

Flanking transmission along a façade became a concern in countries where construction technology connected lightweight aluminum façade assemblies to heavy weight concrete floor slabs. Experiments and prediction of potential flanking at the junction was examined by Martin with an apartment building in the Netherlands.⁴² Later the *in situ* measurements were reported once the apartment building was complete.⁴³ The result of the *in situ* measurements validated the prior laboratory and prediction study conducted by the team. It was noted that the resilient coupling between the façade and the floor slab was a challenge to predict using methods per ISO 12354 and measured vibration reduction index were required to support the calculation. Once the *in situ* measurements were conducted the team validated that the prediction results showed a dominant sound transmission via the façade, further validating the importance of sound paths at façade connections.

Another example of experimental testing to investigate sound flanking at the façade was conducted by Ando and Koga at the Technical Research Institute of Okumura Corp. and the Kajima Technical Research

⁴¹ J.P. Nagy, "Laboratory for Flanking Sound Transmission of Lightweight Constructions," *Civil Engineering* 18, no. 3 (1974): 169–78.

⁴² H.J. Martin, M.A.E. Schoffelen, and W.M. Siebesma, "Flanking Transmission along an Aluminium Façade – Experiments vs Prediction-," in *Proceedings 17th International Congress on Acoustics Rome*, vol. 3 (ICA, Rome, Italy, 2001).

⁴³ H.J. Martin, M.A.E. Schoffelen, and W.M. Siebesma, "Flanking Transmission along an Aluminium Façade – Experiments vs Prediction-," in *18th Proceedings International Congress on Acoustics* (ICA, Kyoto, 2004).

Institute.⁴⁴ In this case, the façade specimen consisted of lightweight concrete connected to a double stud gypsum demising wall. The test setup used a semi-anechoic chamber to represent the exterior of the façade. The experiment measurements were based on methods from EN 12354-1 2000. Vibration measurements were also conducted. The test setup provided data for sound and vibration characteristics of the flanking path of various excited and radiating areas.

In 2009 the National Research Council Canada (NRC-IRC) introduced an unprecedented flanking sound transmission facility consisting of eight-rooms.⁴⁵ The facility would be used to characterize airborne and impact sound transmission paths between rooms both laterally and vertically and support the development of designs in accordance with building code requirements. The facility is most predominately used for wood framed constructions. The NRC-IRC has extensive publications relevant to sound flanking transmission prediction models using semi-empirical, statistical, and analytic methods, involving collaborators from different countries.

The Building Research Establishment (BRE) in the UK provides UKAS accredited sound testing at their sound flanking laboratory. The facility is used to compare sound isolation performance data with building regulations in accordance with ISO measurement standards.⁴⁶

Curtain wall manufacturers, such as Permasteelisa Group and Schüco have also built research laboratories to conduct acoustic test measurements in order to improve design and installation. Permasteelisa has a *Laboratory for Acoustic Research on Glass and Large Envelopes* (L.A.R.G.E) located in Italy. Schüco has a research facility called the *Technology Center* that includes a four room laboratory independent from one another to conduct various acoustic testing.⁴⁷

Schüco has conducted sound flanking research studies on glass curtain wall facades in accordance with DIN 52210 Part 7: Airborne and impact sound insulation, calculation of insulation against noise transmission” at the ift Rosenheim laboratory in Germany. One research study was conducted in 2000 on a non-unitized system where modifications were made to the mullion and transom profiles. Information in this test report is proprietary.⁴⁸

In 2004 Schüco conducted another study on sound flanking transmission at the ift Rosenheim lab on the currently known ‘USC 65’⁴⁹ mullion, which at the time was called the ‘Skyline S 65F’. This research study tested the sound flanking transmission of a full scale ‘Skyline S’ curtain wall rig in accordance with ISO 10848. The frame profiles were modified with mass and damping materials to measure the flanking transmission with reduced influence at certain areas of the curtain wall assembly.⁵⁰ Additionally, predictive calculations were used per ISO 12354 to estimate normalized flanking level differences, $D_{n,f,w}$ (reference Table 2-2).

⁴⁴ Kei Andow and Takashi Koga, “Experimental Study on Effect of Lining for Flanking Transmission of Building Facade,” in *RBA-04 - SOUND INSULATION OF MULTI-FAMILY DWELLINGS*, RBA-04 - SOUND INSULATION OF MULTI-FAMILY DWELLINGS (Forum Acusticum Sevilla 2002, Sevilla, Spain, 2002), 6, <http://www.sea-acustica.es/Sevilla02/rba04002.pdf>.

⁴⁵ F. King T. Estabrooks, “NRC-IRC Flanking Sound Transmission Facility,” *National Research Council Canada*, no. NRCC-51390 (October 2009): 3, doi:irc_id:20490.

⁴⁶ “BRE Group: Acoustics Laboratory,” accessed March 24, 2012, <http://www.bre.co.uk/page.jsp?id=1146>.

⁴⁷ “Sound Insulation of the Original Component” (Schüco, n.d.), http://www.schueco.com/web2/de-en/investors/technology_center/specialist_areas.

⁴⁸ Laing, “Systems for Facades, aluminum/PVC-U Windows and Doors - Fittings,” Acoustic Laboratory Test, Insulation against Noise Transmission for Facades (Germany: Institute for Window Technology (ift) Rosenheim, November 13, 2000).

⁴⁹ Schüco, “Overview of Profiles for Schüco Facade USC 65,” accessed May 19, 2014, http://schilloh.2netmedia.de/pdf/produkte/fassaden_daecher/172256.pdf.

⁵⁰ Bernd SaB and Ulrich Sieberath, “Classification Report, Sound Reduction and Flanking Transmission Loss of Building Elements,” Acoustic Laboratory Test, Schuco Skyline S 65 F (Germany: ift Rosenheim, August 25, 2004).

Research studies and testing conducted by curtain wall manufacturers such as Schüco is often proprietary and therefore may routinely conduct these type of laboratory measurements for a designated client entities.

2.4.2 SOUND FLANKING PREDICTION METHODS

Although the prediction of sound flanking transmission is outside the scope of this research study, it is noted that there continues to be research investigations to predict sound flanking paths at lightweight building elements. Further development in this field of research may be applied to the results of the proposed UVM test measurements described in Chapter 3.

The only method to analytically predict sound flanking in building elements is found in the international standard ISO 12354-1. The method is typically applied to heavyweight homogeneous building elements and therefore is not entirely applicable to lightweight elements such as curtain wall mullions. The apparent sound reduction index of building elements relies in comparing the results of the measurements obtained according to ISO 140-6.⁵¹

An experimental study was conducted by researchers at Lund University in Sweden that studied flanking transmission in lightweight buildings that used the EN 12354-1 calculation prediction standard. They found that the standard used in lightweight applications predicted the transmission loss to be lower than other tested methods. “The EN 12354-1 standard overestimates the transmission in lightweight buildings by 1 to 8 dB. The orientation of the floor beams is important for transmission in the low frequency range. Continuous floor plate as connector transmits the same amount of energy at high frequency independent of floor beams orientation. This connector transmits the same amount of energy at high frequency independent of floor beams orientation. This connector also has the best agreement with the EN 12354-1 standard.”⁵²

The ISO standard EN 12354 for predicting flanking transmission, it is understood that bending waves are primarily considered because this wave type has an out-of-plane displacement normal to the surface of the building element, typically the dominant motion for acceptance and radiation of sound by a surface. Further, building elements are usually weakly coupled at the junction and only the resonant wave component, due to free bending waves, is transmitted structurally from one element to the other.⁵³ The prediction method in EN 12354 is intended for homogeneous heavyweight monolithic structures and is therefore not valid for lightweight hybrid curtain wall mullion assemblies.

Carl Hopkins, who is currently a professor at the University of Liverpool and previously with the Building Research Establishment published a book which comprehensively discusses the theory of sound and vibration in buildings called *Sound Insulation*.⁵⁴ The book includes sound isolation measurement and prediction methods for application to the design and construction of buildings. Sound flanking prediction methods are discussed with respect to statistical energy analysis.

⁵¹ B. Szudrowicz and A. Izewska, “Empirical Verification of the Prediction Model Designed to Estimate the Flanking Transmission in Buildings,” in *Proceedings 17th International Congress on Acoustics Rome*, vol. 3 (ICA, Rome, Italy, 2001).

⁵² Lars-Göran Sjökvist, “Flanking Transmission in Lightweight Buildings” (Lund University, Sweden: Department of Engineering Acoustics, 2004), <http://lup.lub.lu.se/record/929711>.

⁵³ T. R. T. Nightingale, “On Using Multiple Kij’s in the EN12354 Acoustics Prediction Model to Represent Excess Attenuation in Flanking Surfaces” (Proceedings of the 17th International Congress on Acoustics, Rome, Italy, 2001).

⁵⁴ Carl Hopkins, *Sound Insulation* (Elsevier / Butterworth-Heinemann, 2007).

Currently there are various software prediction programs understood to estimate sound transmission including BASTIAN®, ENC®, WinFLAG®, Sound of Numbers®, Insul®, COMSOL® and Abaqus®. Based on research conducted at Chalmers University of Technology, BASTIAN® can provide a reliable prediction of sound flanking; however it is necessary for the user to have a theoretical understanding of the calculation factors in order to make appropriate adjustments.⁵⁵ The research also states that BASTIAN® is a reliable prediction program with the exception of low frequency discrepancies, which can be expected since measurement uncertainties typically occur in this range.

2.4.3 PRECEDENT ACOUSTIC TEST MEASUREMENTS OF CURTAIN WALL ELEMENTS

Lateral sound transmission measurements across glass curtain wall elements has been studied and tested by acoustic consultants and façade engineers for projects in the US and abroad. Available information from the measurement reports can be limited since commissions are often proprietary and arranged by client or owner entities for performance based designs.

A case study consisting of *in situ* lateral sound transmission measurements at a curtain wall mullion was presented by Louwers⁵⁶ in 2012 at the Inter-Noise conference. The intent of the measurement study was to reduce sound flanking transmission at the vertical curtain wall mullion by modifying the profile (filling the façade stud or applying panel damping). The results indicated significant improvement with fill and cladding additions to the mullion. However the best performance was achieved with a split mullion (Figure 2-10).

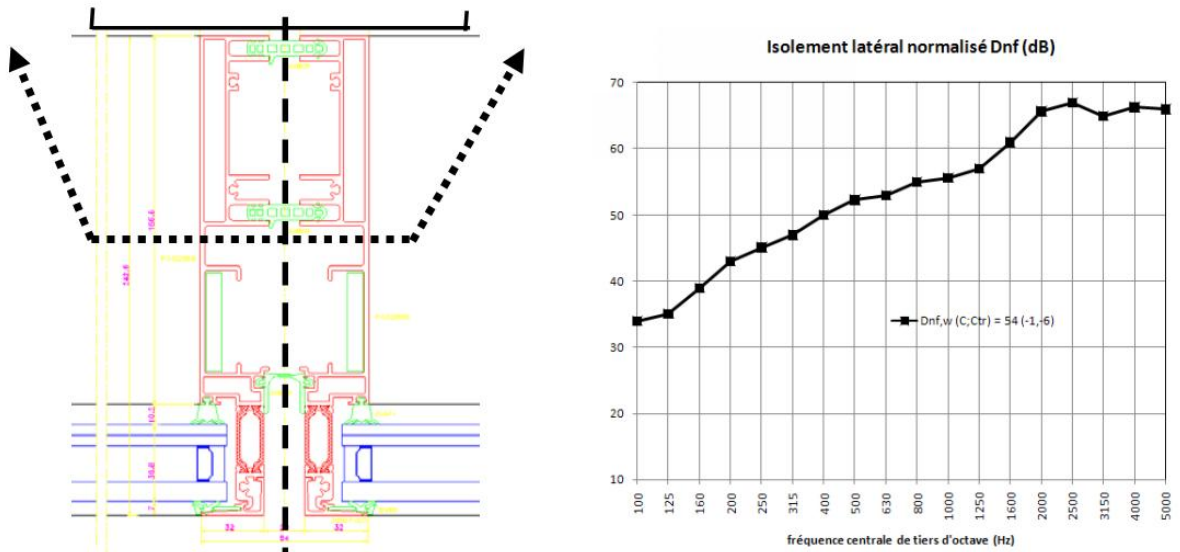

FIGURE 2-10: PLAN DRAWING OF “SPLIT” MULLION (LEFT) AND D_{NF} PERFORMANCE (RIGHT) (IMAGE: LOUWERS, 2012)⁵⁷

⁵⁵ Jason Esan Cambridge, “An Evaluation of Various Sound Insulation Programs and Their Use in the Design of Silent Rooms” (Chalmers University of Technology, 2006).

⁵⁶ Marc Louwers, “Improvement of Acoustical Flanking Transmission through Light-Weight Façades,” in *INTER-NOISE and NOISE-CON Congress and Conference Proceedings*, vol. 2012, 10 (Institute of Noise Control Engineering, 2012), 1998–2003.

⁵⁷ Ibid.

A split mullion is one where the stiffening connections on either side of the internal mullion cavity do not mechanically connect. Instead they are joined by a resilient rubber gasketing connection.

The mullions measured in the study were of a different type where the internal cavity did not have interstitial stiffening connections. This mullion was modified and measured on site, initially with a mineral wool fill and then an overclad with a damping material and 2mm steel plate. The single figure rating difference between the filled mullion and the overclad mullion with fill was 3dB $D_{nf,w}$.

All field tests in the Louwer study included a higher performing demising wall, therefore it was noted that the Df and Fd paths would be dominated by the Ff path (see FIGURE 2-9 for reference acronyms).

It was also noted in the Louwer study that limited data was available to compare the mullion profile modified with and without mineral wool fill. Chapter 4 includes this type of comparison as well as other modifications to the same mullion profile.

Professional consulting firms such as Veneklasen Associates (VA) in the US have conducted an extensive amount of field testing to better understand inter-spatial sound flanking transmission. Associates from the firm John LoVerde and Wayland Dong presented historical detailing and modification to intersection at curtain systems in 2008 and correlated the test data with various constructions.⁵⁸ This work identified the extent of architectural interventions required in order to create robust sound isolation commensurate with the demising partitions. It provided an indication of mullion modifications required to improve the NIC rating. The performances ranged from approximately 30dB to 65dB where the higher performing façade assemblies included two mullions separated by a wide spandrel pane. All field tests included a high performing demising partition that varied per test.

The research and development team at Enclos Corporation, a leading firm of façade engineering and curtain wall designers, has investigated various sound isolation issues associated with curtain wall building facades, including sound flanking transmission vertically and horizontally. They collaborated on an acoustic study with Veneklasen Associates on the *LA Live* project in Los Angeles, CA. The Enclos Corp team summarized their work in a report titled *Inter-Story Acoustical Evaluation of Unitized Curtain Wall Systems*⁵⁹ in 2008 that set a precedent for the proposed work in this research study. The focus of the Enclos work was on sound transmission between vertical adjacencies at residential and hotel dwellings of the LA Live Ritz Marriott building. This acoustic issue is especially important where the hollow internal cavity of the vertical mullions spanned double-story heights between dwellings.

They evaluated, “the effect of [the] continuous pathway for airborne sound through the vertical mullion on inter-story acoustical performance.” They proposed, “If found to be significant, identify strategies that can be employed to mitigate the effect.”⁶⁰ The vertical transmission path was tested with a test rig that included vertical mullion members. Two issues were investigated: the continuity of the aluminum members without a stack joint across the double height and the void in the center of the mullion as continuous to allow a conduit for sound. The study enabled the team to improve the sound transmission performance of the vertical mullion and identify modifications providing the most value acoustically and economically.

⁵⁸ LoVerde and Dong, “Methods for Reducing Flanking Airborne Noise Transmission through Mullions of Curtain Wall Systems.”

⁵⁹ TJ Dehghanyar et al., “Inter-Story Acoustical Evaluation of Unitized Curtain Wall Systems” (Culver City, CA: Enclos Corp, July 2008).

⁶⁰ Ibid.

The tests were conducted at the Western Electro-Acoustic Laboratory (WEAL) in Valencia, CA. An image of the lab test setup is shown where the aluminum curtain wall element has been separated from the curtain wall system and located in an aperture in the filler wall. Testing was conducted per ASTM E90.

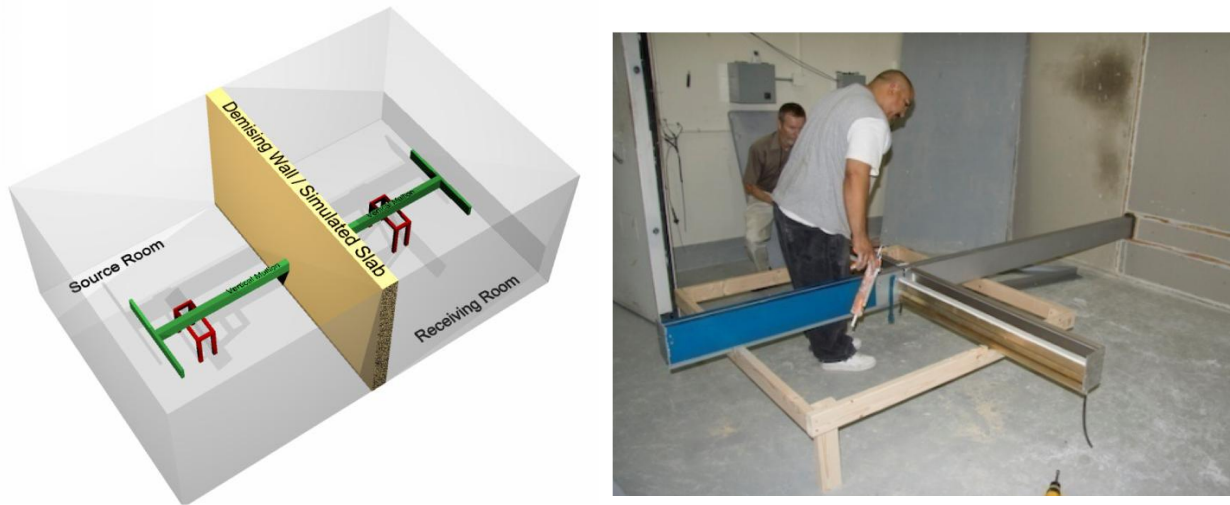

FIGURE 2-11: SIMULATED FLOOR SLAB CONDITION AND TEST CHAMBER CONFIGURATION (LEFT) AND PHYSICAL TEST SETUP (RIGHT), (IMAGES: ©ENCLOS CORP)⁶¹

The conclusions from these tests indicated that significant acoustic improvements can be made to the mullion condition by either capping the ends where the mullion discontinues, using interior finishes to close the air path at the mullion termination, or by adding an insulation plug at either end of the vertical mullion length. It was noted that structure sound transmission significantly contributed to the overall sound levels.

Subsequent to the inter-story investigation, Enclos continued to do conduct studies at WEAL on horizontal mullion acoustic performance and summarized findings the following year in a presentation titled *Partition Mullions: Curtain Wall Acoustical Enhancements*.⁶² Two mullion systems were studied and compared to an unmodified mullion condition (System A) an overclad consisting of an MLV layer and aluminum plate and (System B) an aluminum tube overclad filled with MLV pillows and attached to the mullion with Pac-International RSIC® clips.

Images of the latter modification and test rig set up are shown in FIGURE 2-12.

⁶¹ Ibid.

⁶² TJ Dehghanyar, "Partition Mullions: Curtain Wall Acoustical Enhancements" (Enclos Studio, January 29, 2009).



FIGURE 2-12: TEST SPECIMEN OF AN OVERCLAD MULLION ELEMENT AND LOCATION IN THE FILLER WALL APERTURE (IMAGES: © ENCLOS CORP)

Laboratory Sound Transmission Loss results from the test are plotted (FIGURE 2-13).

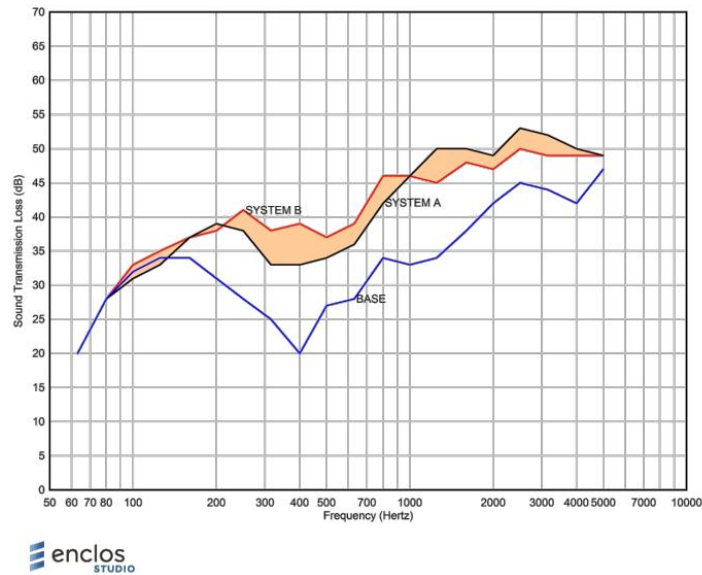

FIGURE 2-13: TL OF THE MODIFIED MULLIONS (IMAGES: © ENCLOS CORP)

Modifications in both System A and B significantly improved the base mullion performance and it is noted that a dominant resonance frequency occurs at 400 Hz at the base condition.

2.5 SUMMARY OF PROFESSIONAL BACKGROUND AND PRECEDENT RESEARCH

This chapter provided background research about acoustic conditions and performance evaluation of the curtain wall mullions to support Objective 1. The architecture of the vertical mullion was acoustically evaluated for architectural mechanisms that enable sound flanking transmission paths. Methods for improving sound isolation performance by modifying the curtain wall design was identified by methods conducted by design consultants and by manufactured products. The proposed architectural interventions are typically applied to vertical mullions and do not necessarily take into account other architectural connections or sound flanking across the glass infill.

New building design projects are required to comply with codes and standards respective to project location. Code dictates the absolute minimum requirements for health, safety, and/or disturbance limitations. Legislative requirements for residential sound isolation in the United States are low compared to certain international regulations. Therefore incentives for improvement are limited in the US, making it difficult to convince owner or developer entities to approve a higher performance standards, especially when the acoustic testing and enhanced design adds cost to a project.

Acoustic test methods per ASTM and ISO standards for façade sound transmission were identified and broadly compared. Field and laboratory performance specific to flanking sound transmission is generally limited with ASTM standards, whereas ISO standards provide more developed procedures. There is no existing sound flanking prediction method within ASTM standards and predictive sound flanking methods provided by ISO standards are limited since typically applied to heavyweight monolithic homogenous barriers. Currently, techniques to improve the prediction of sound flanking methods for lightweight systems are in development.

Precedent research on sound flanking transmission was reviewed for known laboratories conducting measurements on curtain walls as well as analytical prediction methods to calculate sound flanking. Laboratory and field test methodologies for lateral sound transmission at the curtain wall are often limited since the elements are part of a composite, making it a challenge to identify which component contributes to the dominating sound flanking path. Lateral sound transmission measurements for curtain wall systems are more often tested as a composite and not necessarily per their individual parts. Although there are a few investigations conducted by professional curtain wall manufacturers who are testing individual elements disassociated from the curtain wall glazing.

There are various calculation and physical measurement techniques to evaluate and rate sound flanking elements, such as with ISO 10848 and ISO EN 12354 methods. In addition to this, acoustic software has been developed using statistical energy analysis and finite element analysis models to predict transmission loss.

Additionally curtain wall case studies were evaluated to inform the test procedures and methods proposed in this research study. Specifically the acoustic studies conducted by Enclos Corp⁶³ provided valuable results to spearhead the test experiment proposed in Chapter 3. Beyond the precedent research described in this chapter, it is not currently known if curtain wall test measurements have been conducted by others in the US on elements associated with the curtain wall façade both independently and as a composite to identify and compare acoustic characteristics of the architectural elements, in the absence of an interconnecting partition.

⁶³ Dehghanyar et al., "Inter-Story Acoustical Evaluation of Unitized Curtain Wall Systems."

CHAPTER 3 UNITIZED VERTICAL MULLION RESEARCH METHODOLOGY

3.1 INTRODUCTION

This chapter describes the methodology of the proposed research experiment and analytical analysis procedure. An overview of the methodology to support the research objectives is outlined below.

1. Review of Mullion Practice and Procedures

- Identify sound flanking paths in a unitized curtain wall system
- Identify existing methods of measuring transmission loss for curtain wall systems
- Identify current architectural interventions to improve the sound isolation performance at mullions

—————→ Chapter 2

2. Mullion Test Experiment

- Create a test method to measure the transmission loss of individual and composite parts of a unitized glass curtain wall specimen

—————→ Chapter 4

3. Performance Evaluation and Composite TL Analysis

- Profile the STC performance of each test specimens
- Compare/correlate noise reduction (NR) and transmission loss (TL) levels and frequency regimes
- Apply transmission loss levels to predictions using the composite TL equation

—————→ Chapter 5

TABLE 3-1: OVERVIEW OF APPROACH TO RESEARCH STUDY

As part of the first research objective, the background review revealed the anatomy of the unitized curtain wall system and how its design inherently leads to sound flanking path weaknesses. Mitigation of these weaknesses has been studied and measured by others in the industry. The investigation reveals limitations with these approaches and that individual parts of the curtain wall system have not been evaluated in a uniformly systemic method.

The background review supports the experimental test proposed to support Objective 2. This involves measuring the transmission loss performances of individual and composite components of the curtain wall specimen in a laboratory setting.

Results from test experiment will be applied to two different analytical analysis methods to meet research Objectives 3 and Objective 4. An evaluation of the performance results will be compared between and within test phases and the applied to a Composite TL calculation method.

3.2 REVIEW OF ACOUSTIC PRACTICES AND PROCEDURES AT CURTAIN WALL FACADES

The background review in Chapter 2 broadly identified laboratory test procedures for sound isolation and current methods of design interventions for curtain wall mullions. Standards for measuring and predicting lightweight systems, eg. glass curtain walls, are under further development for ISO and ASTM methodologies. The common US standards for airborne sound isolation testing of building specimens in a laboratory is the ASTM E90 method.

Sound transmission tests for curtain wall systems have been conducted by laboratory institutions in the past; some known studies for sound flanking were conducted per Schüco. The review of the laboratory test results demonstrated a challenge to distinguish which building element of the system contributes most significantly to the overall sound transmission loss performance.

The empirical test method proposed in this research study is unique in a laboratory that conducts sound transmission measurements per the ASTM E90 procedure. The method obtains the sound isolation performance of individual elements that comprise the curtain wall system and provides a relative means for comparison between modified elements. All boundary conditions are uniform by maintaining a structural break between the test element and laboratory.

3.3 LABORATORY TEST PROCEDURE

The test method will be designated the UVM (Unitized Vertical Mullion) Method. The UVM experiment will measure individual and composite parts of a curtain wall specimen. The approach consists of physical laboratory tests so that the acoustic limitations of architectural interventions used in practice can be quantified and relative comparisons between tests may be made.

The method primarily investigates the acoustic performance of three specific elements associated with construction mechanisms supporting sound paths across the curtain wall system:

1. the vertical mullion extrusion,
2. the building connection element between the mullion and interior partition, and
3. the glass infill and aluminum framing.

In order to measure the independent transmission loss of the first two building specimens, they must be decoupled from the curtain wall system.

Components of the glass curtain wall system to be measured are identified, each component or specimen defines a test phase, and an approach to measure the lateral sound transmission loss (TL) across the specimens is also described (Table 3-2).

TEST PHASE	MEASURED SPECIMENS (ISOLATED AND COMPOSITE)			MEASUREMENT APPROACH
	Mullion	Connection	Glass Curtain Wall	
PHASE 1	●			Individual unitized mullion measured with and without architectural modifications at the external face and/or internal air cavity
PHASE 2A	●	●		Individual mullion measured with various resilient demising wall connections
PHASE 2B		●		Resilient demising wall connections measured in the absence of a mullion
PHASE 3	●		●	Center mullion between two glass curtain wall bays measured as a whole

TABLE 3-2: UVM METHOD DESCRIPTION

The three phases in the UVM method are directly associated with the three sound flanking transmission paths (Figure 3-1).

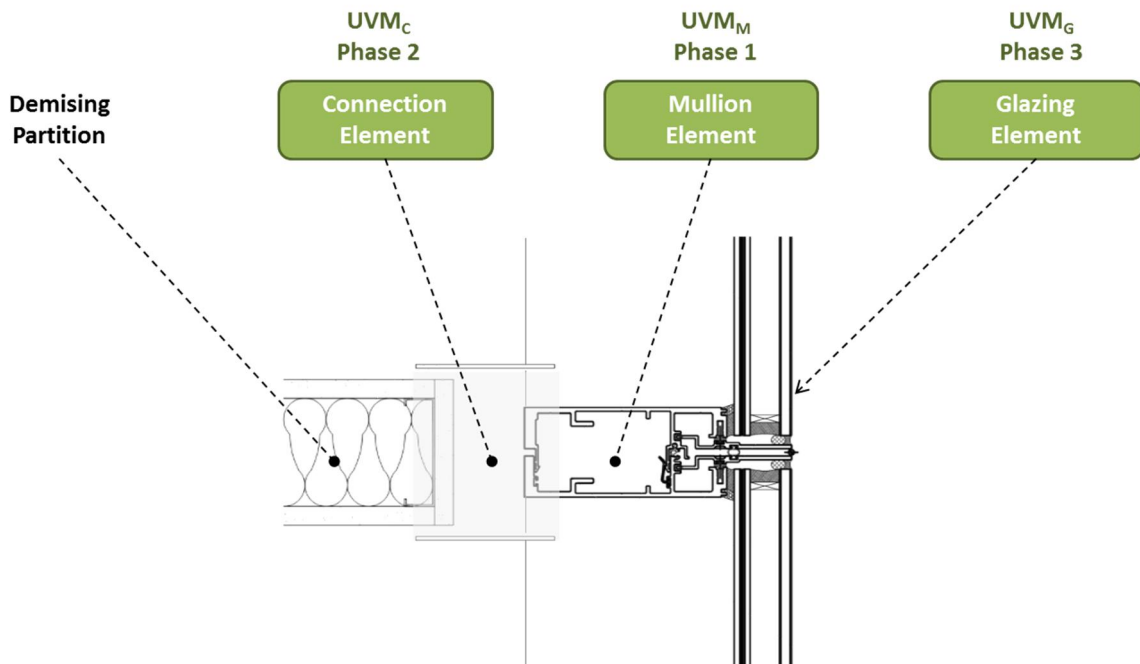

FIGURE 3-1: PLAN DIAGRAM OF BUILDING ELEMENTS AND TEST PHASES ASSOCIATED WITH THE CURTAIN WALL ASSEMBLY

All measurements will be conducted at the Western Electro-Acoustic Laboratory (WEAL), an acoustic laboratory in Santa Clarita, California. The testing will be in accordance with ASTM E90-09 Standard Method for Laboratory Measurement of Airborne Sound Transmission Loss of Building Partitions.

The laboratory tests will be limited to lateral sound transmission loss. Vertical sound transmission loss at curtain wall systems is not conducted as part of the laboratory set-up although many mechanisms influencing sound flanking are not mutually exclusive vertically or laterally.

Phase 1 UVM_M

Modifications to these building elements will also be tested during each phase to identify the highest practicable STC that may be achieved and acoustic findings relevant to performance. These will create subcategories in each phase, for example in Phase 1 there are three main subcategories:

Class A – Unmodified mullion constant tests

Class B – Filled mullion tests

Class C – Overclad mullion tests with cladding and/or a combination of fill material

Phase 2 UVM_C

During Phase 2, the connection tests are measured with and without a mullion present. This will be separated into Phase 2a and 2b respectively.

Phase 2 UVM_G

The third phase of the UVM lab tests focuses on the curtain wall glazing. The glass infill will be supported by the perimeter aluminum extrusions of the transom, sill, and vertical mullion. The transmission loss of this system will be compared with the initial Phase 1 UVM_M Transmission Loss. All transmission loss results will be analyzed for critical sound level and frequency correlations as well as composite calculations to understand the influence to holistic system design.

3.3.1 TEST CONSTANTS AND VARIABLES

The physical elemental constant used in the experiment is the unmodified unitized vertical mullion, i.e. hollow and exposed. The TL value in dB of this physical element is compared with mullions that were modified with variable construction materials.

The variable materials are applied to the inside and/or outside of the physical mullion which remains constant throughout most test phases.

3.3.2 CURTAIN WALL SYSTEM SPECIMEN

The curtain wall system was provided by Enclos Corp and decoupled to independently test the vertical mullion separately. Shop drawings of the specimen created by Enclos are shown (FIGURE 3-2 and FIGURE 3-3).

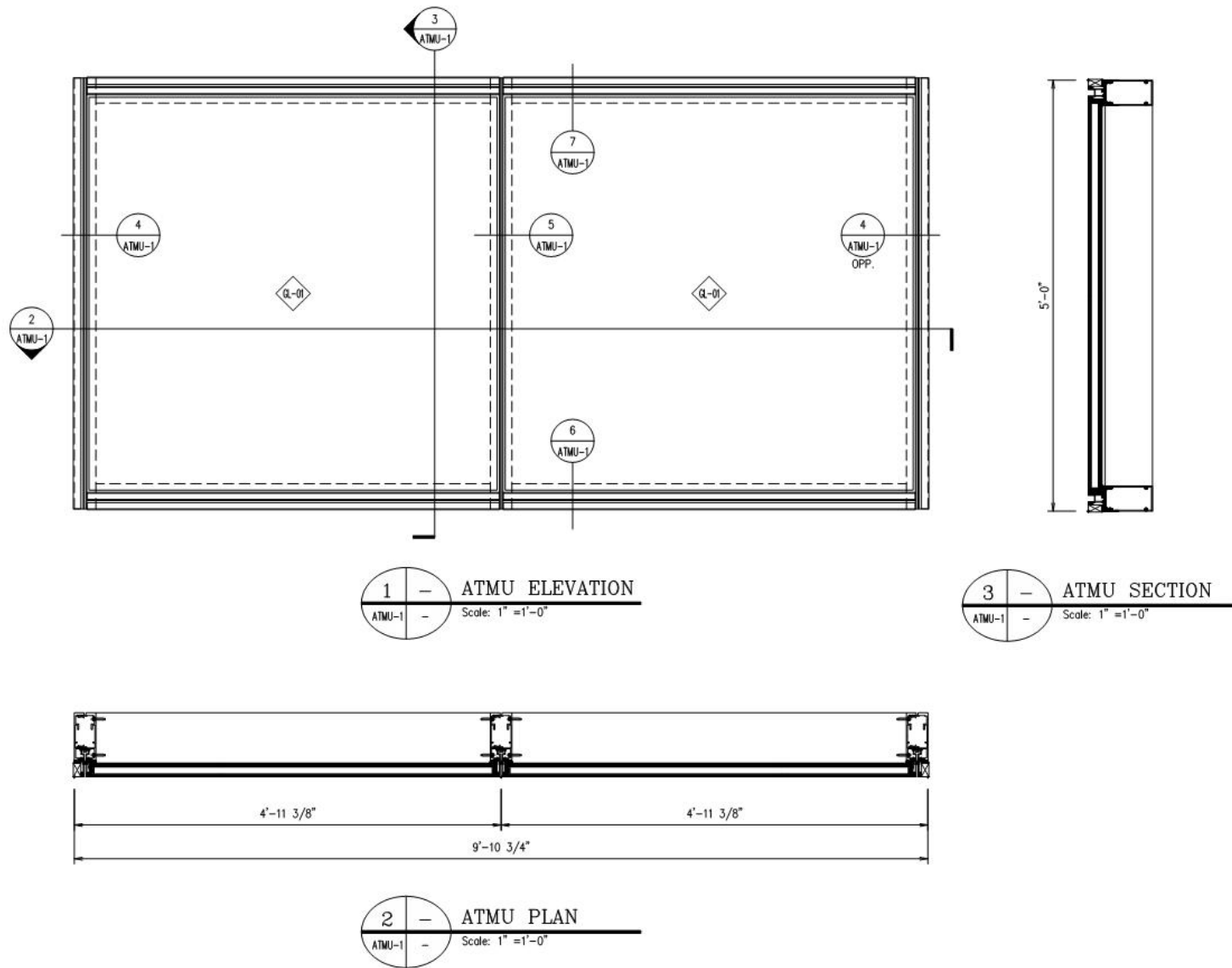

FIGURE 3-2: UNITIZED CURTAIN WALL SYSTEM SHOP DRAWINGS (COURTESY OF ENCLOS CORP), PLAN AND ELEVATION

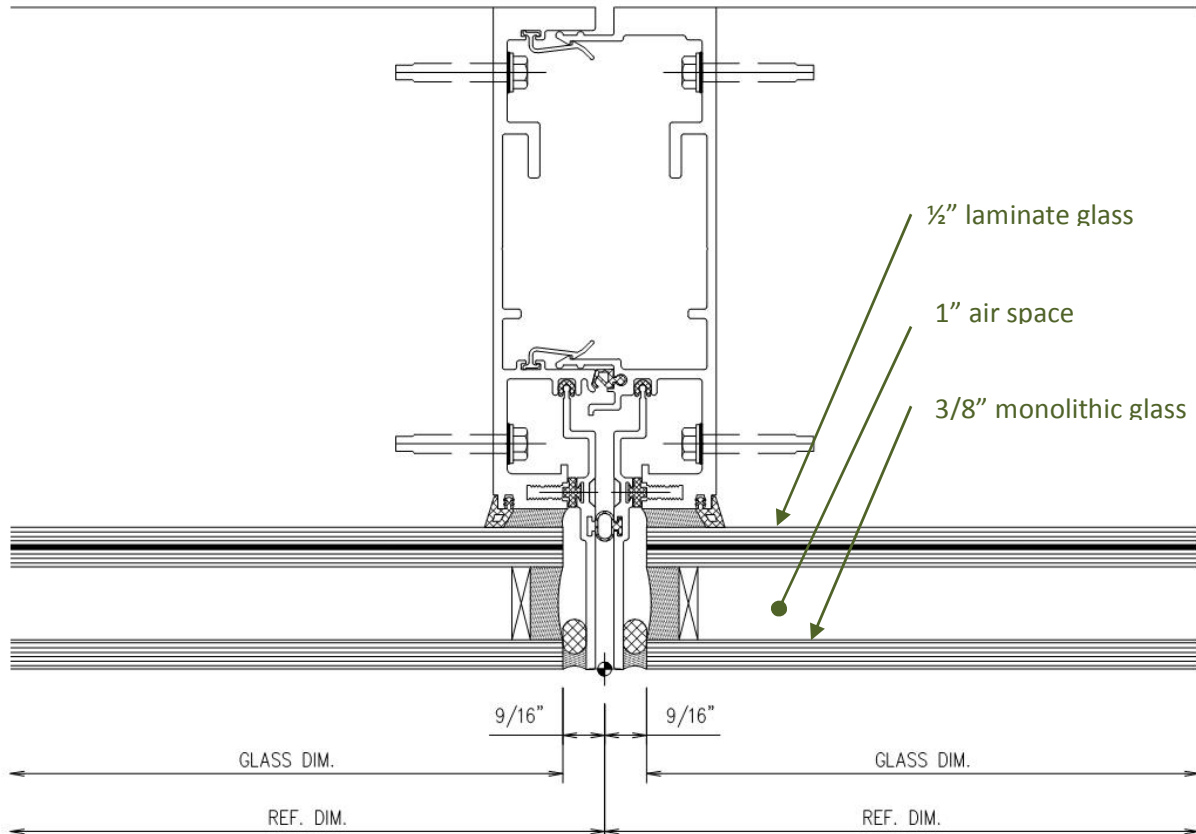

FIGURE 3-3: UNITIZED CURTAIN WALL SYSTEM SHOP DRAWINGS (COURTESY OF ENCLOS CORP), DETAIL AT THE JOINT (DIM. IS DIMENSION, REF. IS REFERENCE)

This curtain wall specimen is a unitized system composed of an aluminum perimeter frame extrusion and insulating glazing unit (IGU) infill (FIGURE 3-2 and FIGURE 3-3).

Two bays of the unitized curtain wall specimen are shown in plan and elevation (FIGURE 3-2). The weight of a single bay weighs approximately 335 pounds. The total height of the curtain wall system is 5'-0" and total length of both bays when connected is 9'-10 3/4". The total surface area of the glass infill is 21.5 ft² at each bay.

The vertical mullion connected to the glass infill is shown in plan (FIGURE 3-3). Its dimensions are 3" wide x 6-3/4" deep x 60" high. The IGU assembly consists of 1/2" laminated glass - 1" air space - 3/8" monolithic glass.

Notes regarding the specimen per phase:

- **UVM Phases 1 and 2** employed the vertical mullion only. Destructive and non-destructive tests were designed to modify the performance of the mullion (Phase 1) and connection (Phase 2A and 2B).
- **UVM Phase 3** included the entire assembly including both glass bays (FIGURE 3-2). The center vertical mullion was modified in this phase only. No connection component was used.

3.3.3 TEST SPECIMEN COMPONENTS

The curtain wall elements used for in the UVM test procedure are individually described below for each phase.

**UVM Phase 1
(Mullion Element)**

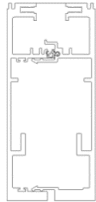

FIGURE 3-4: PLAN DIAGRAM OF THE MULLION USED IN PHASE 1.

The vertical mullion extrusion is shown decoupled from the curtain wall glass, transom and sill system.

The weight of the aluminum mullion element is 26 lbs (11.8 kg) for a 5'0" length.

**UVM Phase 2a and 2B
(Connection Element)**

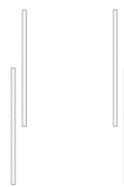

FIGURE 3-5: PLAN DIAGRAM OF A CONCEPT CONNECTION USED PHASE 2.

The connection consists of two parallel aluminum plates which would join a mullion at one end, and an interior wall at the other. Various other acoustic concept connections are measured.

Phase 2a measured concept connections with a mullion. Phase 2b measured concept connections without a mullion.

**UVM Phase 3
(Glass System)**

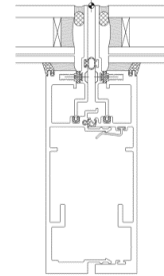

FIGURE 3-6: PLAN DIAGRAM OF GLASS CURTAIN WALL USED IN PHASE 3.

The largest specimen will be used in Phase 3 where the center vertical mullion is coupled between the two curtain wall bays. This includes the glass infill.

All test specimens were placed in an aperture at the filler wall located between two reverberant test chambers (FIGURE 3-7).

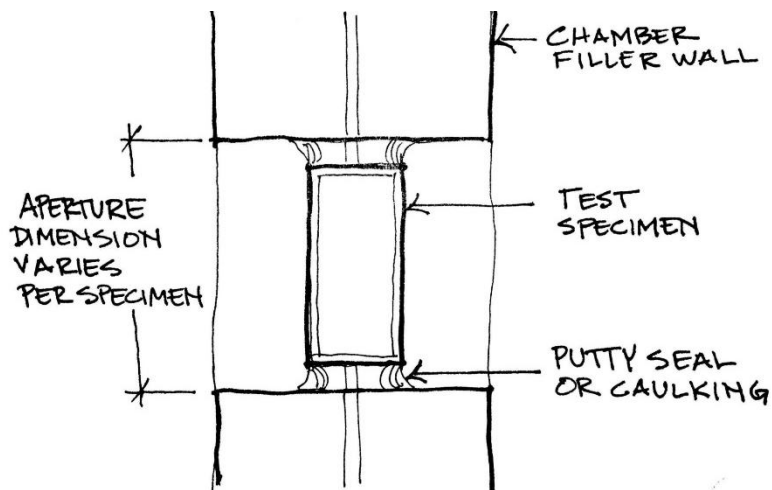

FIGURE 3-7: BASIC SETUP OF THE TEST SPECIMEN LOCATED IN THE TEST CHAMBER FILLER WALL.

3.3.3.1 TEST BASE CASE, CONTROLS AND VARIABLES

The laboratory experiment includes the following conditions so that the results of the test specimens may be analogously compared between phases.

Test Base Case

Two base case performances were obtained with the physical mullion element that remained constant throughout the testing experiment. The base cases are identified in Test Phase 1 and described in Chapter 4.

The lowest performance base case is defined as Mullion Constant 1 (MC1) and the highest performance base case is defined as Mullion Constant 2 (MC2). These base cases are compared to curtain wall building elements tested in Phases 2 and 3. The physical mullion shape and dimension remained constant at all test phases although building mass and damping infill, overclad and connections materials varied.

Test Controls

The boundary condition was controlled at each test phase. This generally required all test specimens to be placed in the filler wall aperture with a minimum ¼" perimeter air gap. The edge condition created by the gap was sealed with an acoustically resilient material, putty or caulking.

The acoustic influence of this boundary conditions is potentially changed by the length of the linear perimeter of a test specimen.

Test Variables

Test specimens were modified with the following variables depending on the test phase.

- Test mullion infill materials: sand, ¼" diameter pea-gravel, damping materials, mineral wool
- Test mullion overclad materials: gypsum board, steel sheet metal, damping materials
- Test specimen edge condition: foam, silicone, rubber gasketing
- Test specimen structural supports: wood battens

3.3.4 LABORATORY TEST CHAMBERS

The laboratory transmission loss test chambers at WEAL include a reverberant sound source chamber decoupled from the reverberant receiving chamber (FIGURE 3-8). A high sound isolating filler wall separates the two chambers. The loudspeaker in the source chamber excites acoustic energy in the room. The resistance to this acoustic energy incident on the test specimen was measured in the receiving chamber. The microphone located in the receiving chamber measured the residual acoustic energy transmitted through the test specimen.

Greater detail for customized test rig preparation and setups are shown in Chapter 4 at each phase.

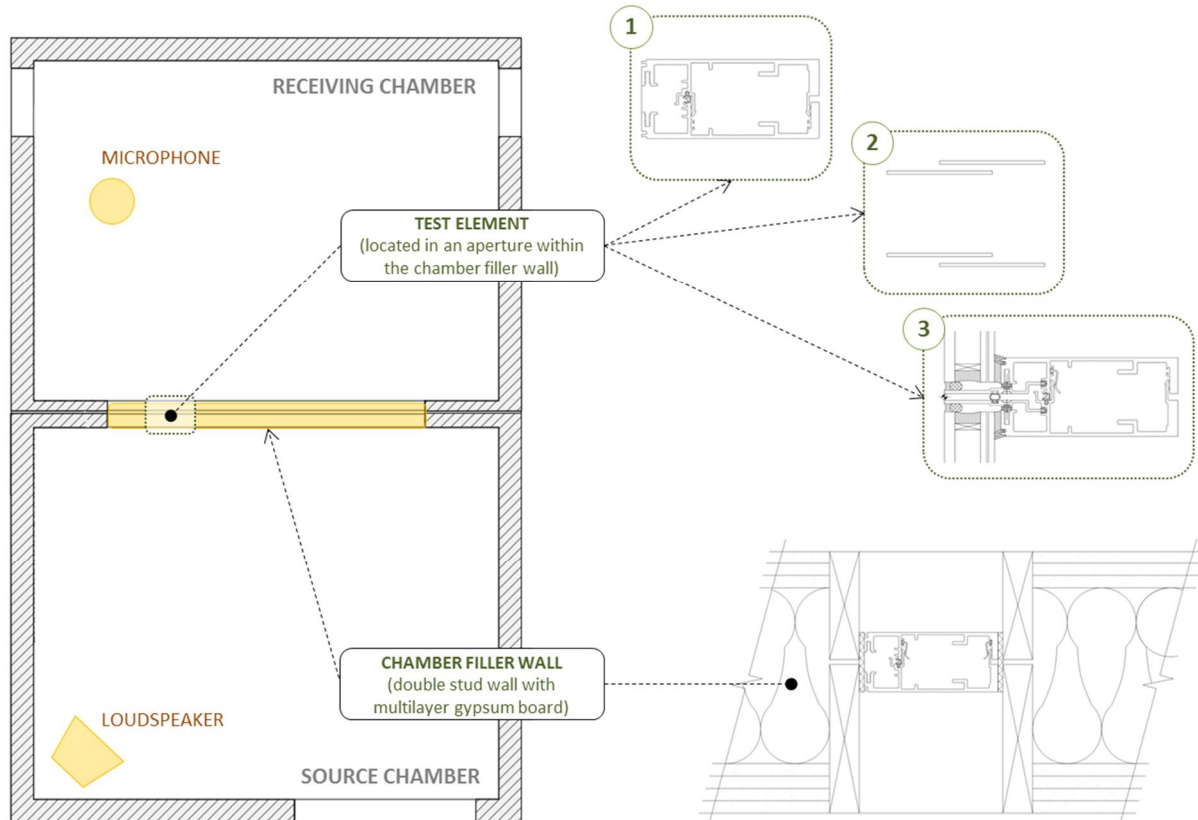

FIGURE 3-8: DIAGRAM PLAN DRAWINGS OF THE TRANSMISSION LOSS CHAMBER AT WEAL AND THE TEST ELEMENTS FROM THE CURTAIN WALL SYSTEM.

The **Receiving Chamber** dimensions are 6.30 m (20.67 ft) x 4.53 m (14.88 ft) x 5.18 m (17.00 ft), and the volume is 148.0 m³ (5226.1 ft³).

The **Source Chamber** dimensions are 6.55 m (21.50 ft) x 5.09 m (16.71 ft) x 6.10 m (20.00 ft), and the volume is 203.4 m³ (7184.6 ft³).

3.3.4.1 FILLER WALL AND TEST SPECIMEN APERTURE

The highlighted wall (chamber filler wall) between the source and receiving chambers represents the extents of the laboratory filler wall at WEAL (FIGURE 3-8). This is the designated wall area typically used

to insert specimen modules for doors, wall, and façade assemblies. The filler wall fills-out the remaining area around a given specimen module size. The sound isolation performance of the filler wall must be high in order to obtain the correct transmission loss value of the test specimen. The filler wall assembly consists of a double stud wall with four layers of 5/8" type 'X' gypsum wall board on the source side and three layers at the receiving side. The wall air cavity is filled with 9" R-30 batt insulation, and the overall width of the wall is approximately 13-1/2". The aperture within the filler wall will be sized to fit the specimens with a perimeter air gap of 1/4" so there is no contact between specimen and filler wall. The single figure transmission loss rating performance for chamber filler wall is STC 74 in accordance ASTM E90.

The total face area of the test specimens varies for every phase.

The test aperture is framed with a set of wood studs consisting of 2"x 6" stud at the receiving side and 2"x 8" stud at the source side. The double wood studs are separated by a 1/4" to 1/2" air space (FIGURE 3-9).

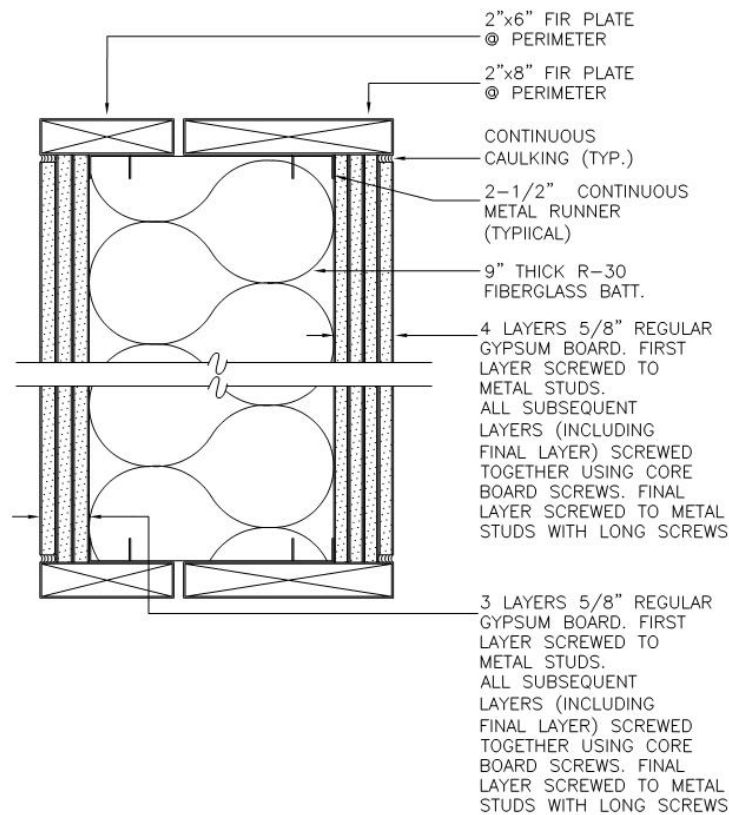

FIGURE 3-9: CHAMBER FILLER WALL CONSTRUCTION (DETAIL COURTESY OF WEAL)

Test specimen was consistently centered unless otherwise noted in the detail descriptions in this section.

Standardized location of the mullion is centered in the chamber.

Comparison examples of a hollow and filled aperture are shown (Figure 3-10 and Figure 3-11).

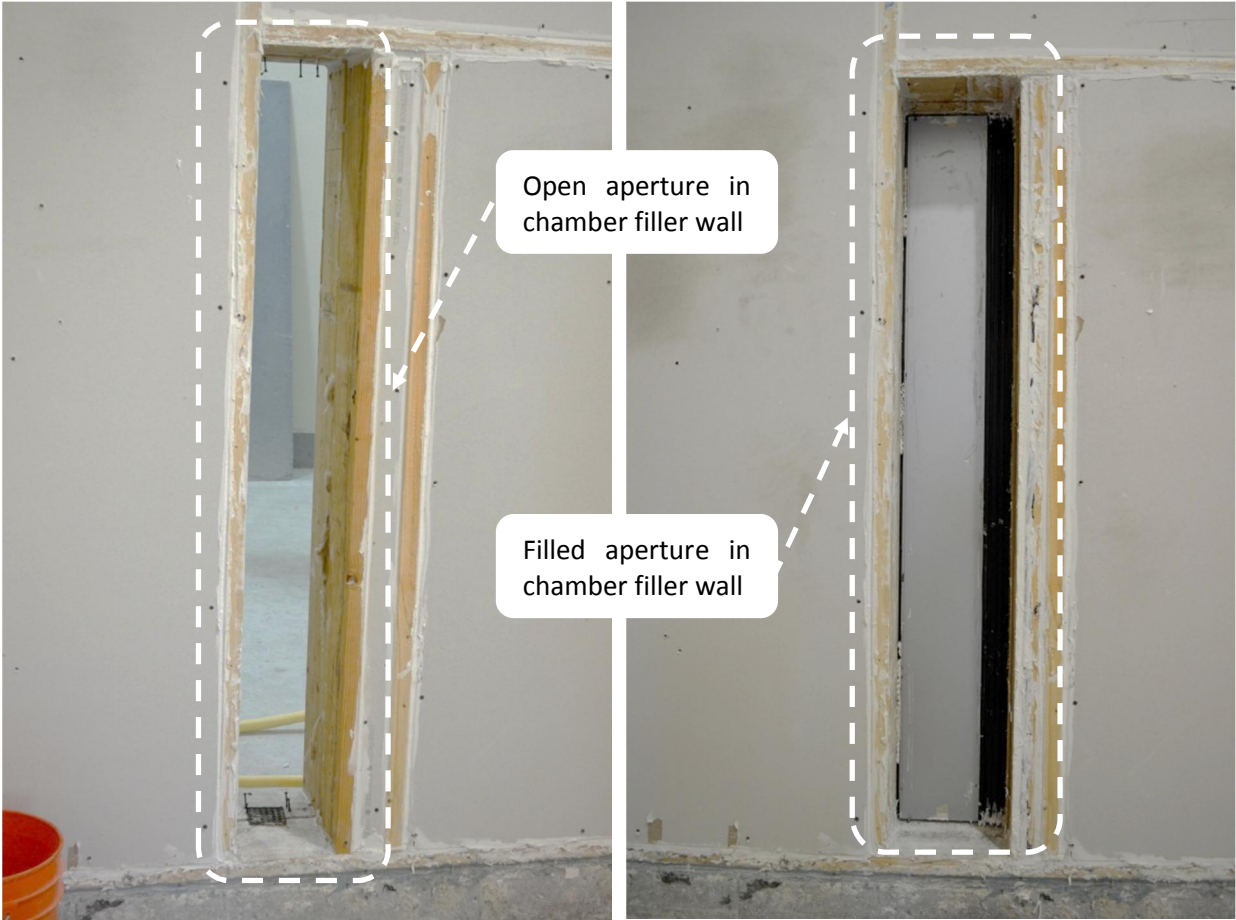

FIGURE 3-10: APERTURE IN CHAMBER FILLER WALL IS OPEN WITHOUT A TEST SPECIMEN

FIGURE 3-11: APERTURE IN CHAMBER FILLER WALL IS FILLED WITH A TEST SPECIMEN (SPECIFICALLY FILLED WITH A MULLION AND SILICONE CONNECTION USED IN PHASE 2A)

3.3.4.2 FILLER WALL TL PERFORMANCE

The transmission loss performance of the filler wall with no aperture is measurement TL13-232 and an open aperture is measurement TL13-331.

Weal Test	STC	Description
TL13-331	0	Filler wall with an aperture (opening of 7-1/4" x 60-1/2")
TL13-232	74	Filler Wall Data (with no aperture)

TABLE 3-3: FILLER WALL TESTS, PERFORMANCES AND DESCRIPTION S

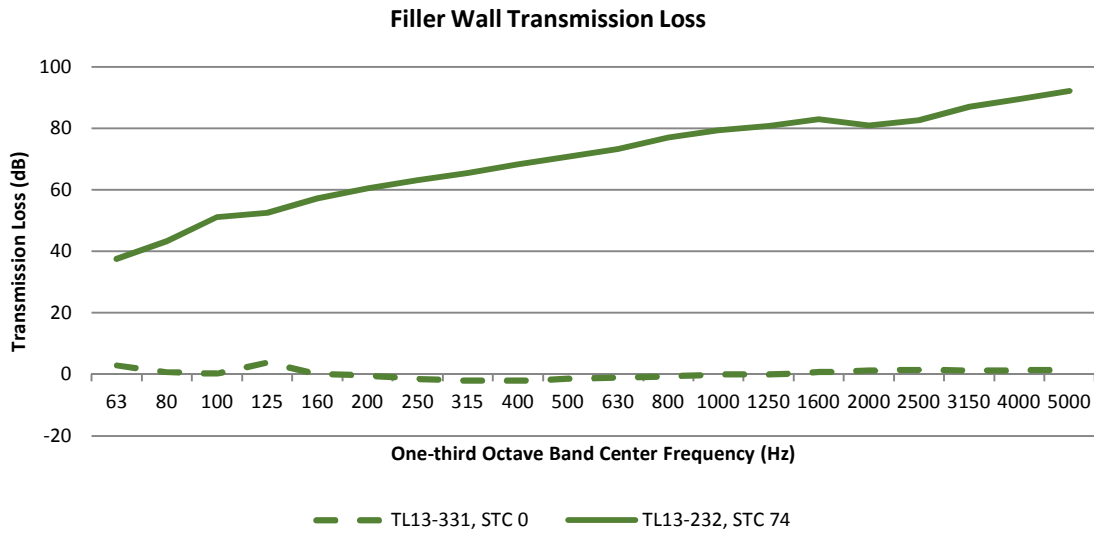

FIGURE 3-12: SOUND TRANSMISSION PLOTS OF FILLER WALL

3.3.4.3 PHASE 3 TEST CHAMBER RIG

A special test rig setup is required for Phase 3. Measuring transmission loss laterally across the curtain wall bay will require the specimen to sit perpendicular to the filler wall. The vertical center mullion between the bays would sit in the filler wall aperture.

Structural reinforcements are required to hold the curtain wall bays on either side of the filler wall. Acoustic detailing to limit the passage of sound at the exterior face of the curtain wall system will be detailed to simulate an outdoor condition. This will limit the sound transmission through the glass that somehow re-enters the area on the other side of demising partitions in practice. This sound transfer will be limited by creating auxiliary semi-anechoic chambers at the outboard side of the curtain wall bay and at either side of the filler wall (FIGURE 3-13). These smaller chambers will be filled with batt insulation and named Chamber 3R at the receiving room and Chamber 3S at the source room.

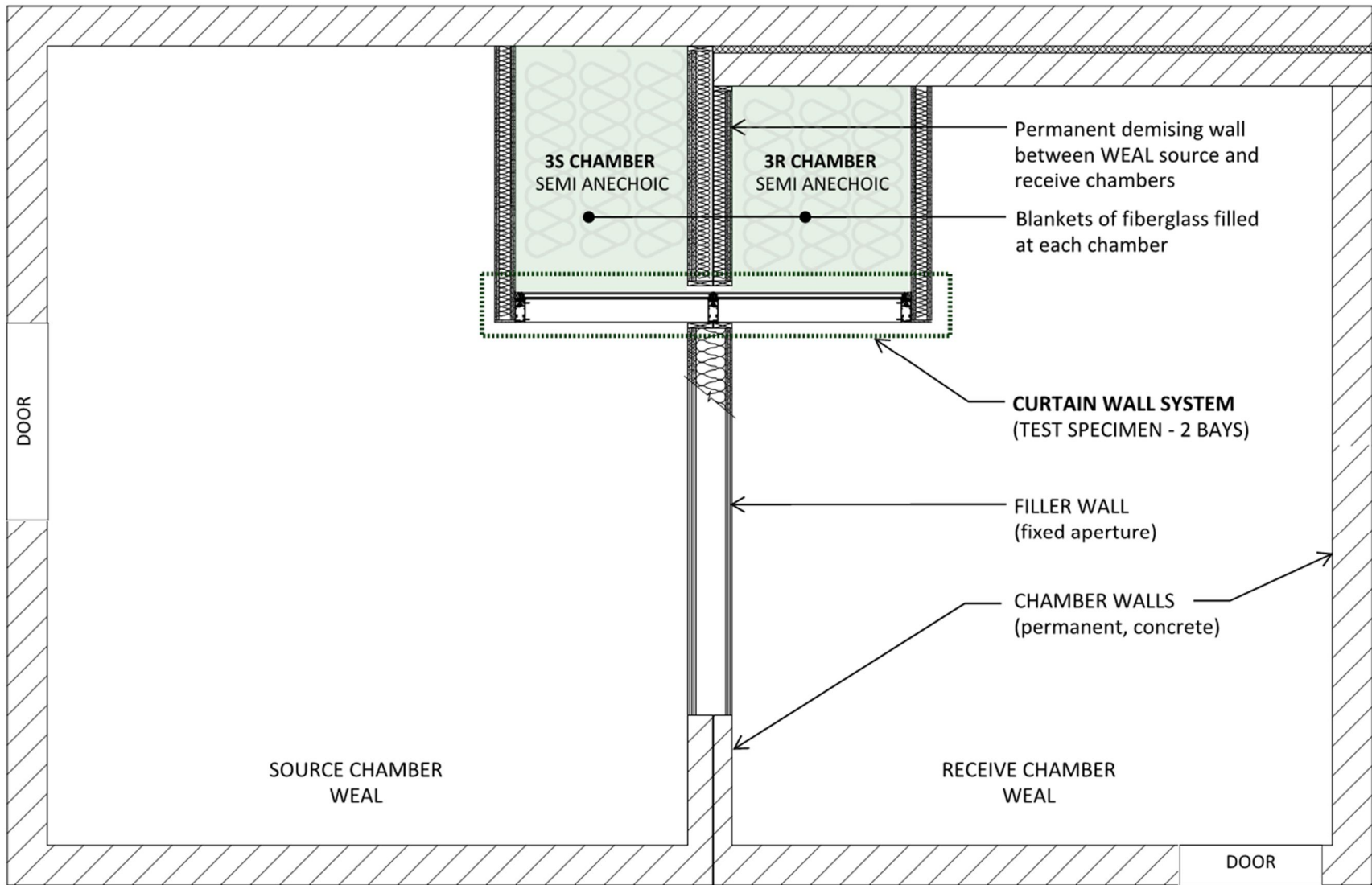

FIGURE 3-13: PLAN DRAWING OF AUXILIARY SEMI-ANECHOIC CHAMBERS 3S AND 3R CUSTOM BUILT FOR THE PHASE 3 TEST MEASUREMENTS

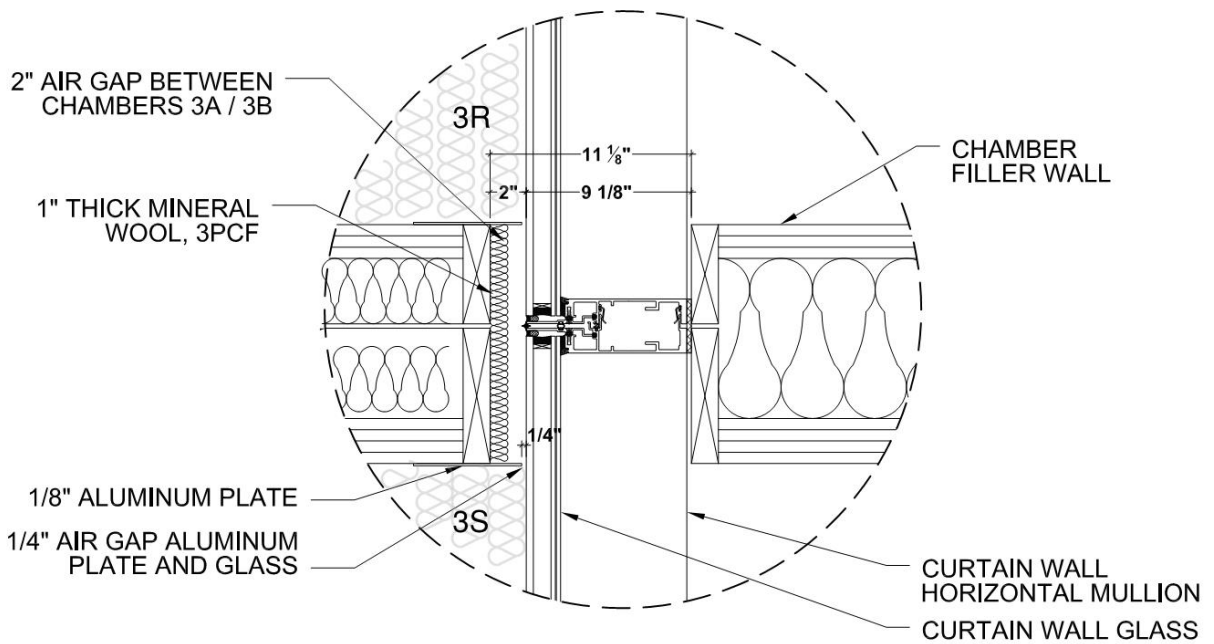

FIGURE 3-14: INTERSECTION DETAIL AT THE WEAL FILLER WALL AND THE CURTAIN WALL BAY

Chamber 3S represents the semi-anechoic enclosure inside the WEAL Source Chamber (FIGURE 3-15 and FIGURE 3-16).

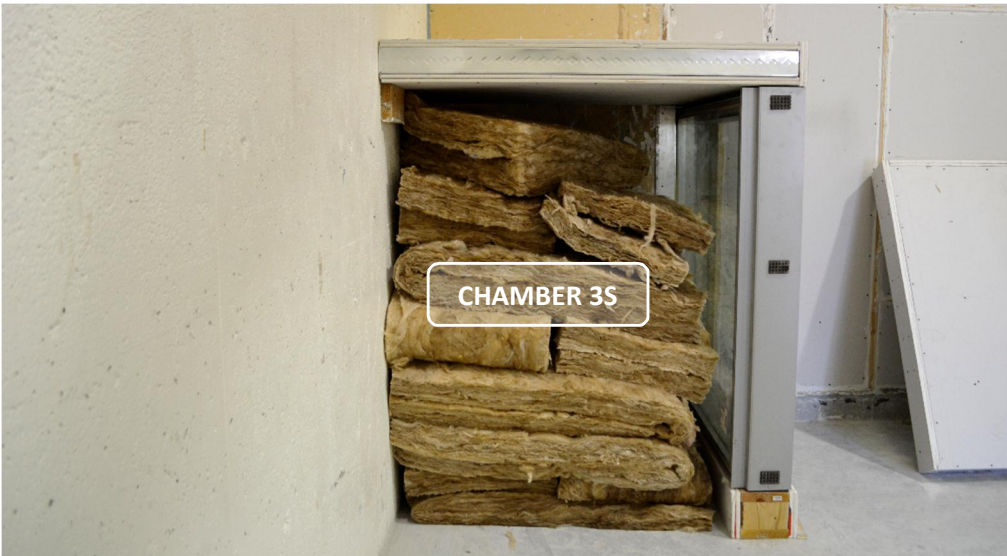

FIGURE 3-15: SEMI-ANECHOIC CHAMBER 3S AT THE SOURCE SIDE FILLED WITH BATT INSULATION



FIGURE 3-16: SEMI-ANECHOIC CHAMBER 3S AT THE SOURCE SIDE

Chamber 3R represents the semi-anechoic enclosure inside the WEAL Receiving Chamber (FIGURE 3-17).

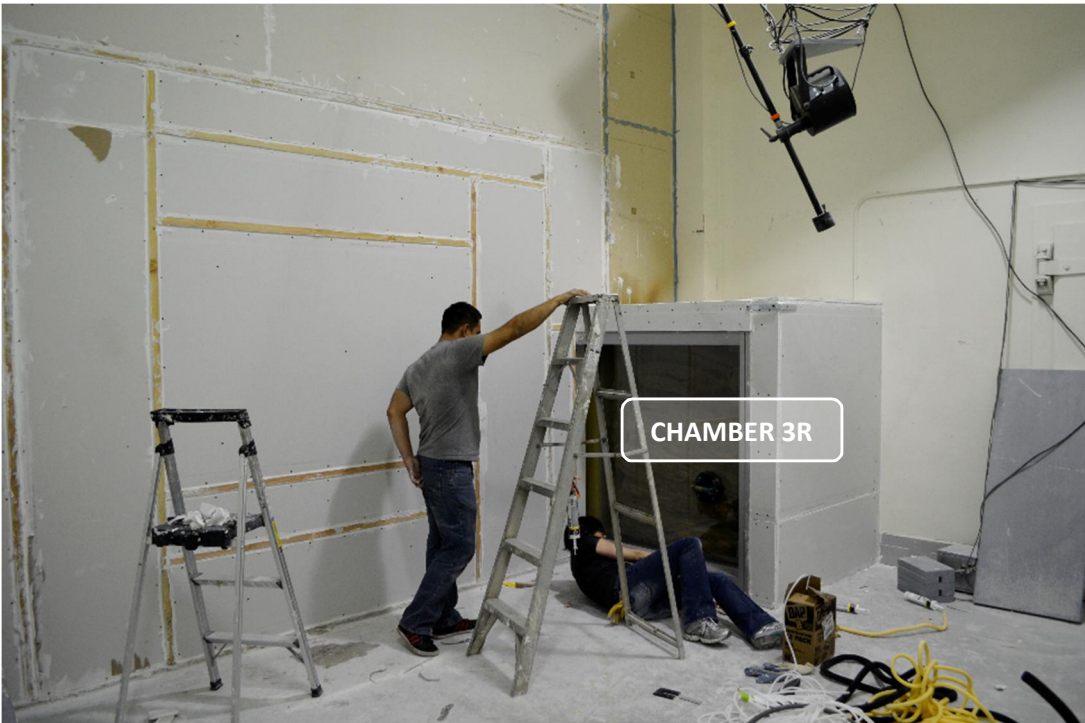

FIGURE 3-17: SEMI-ANECHOIC CHAMBER 3R AT THE SOURCE SIDE

3.3.5 TEST EXPERIMENT FACTORS

1. Flanking paths at the sill and transom have intentionally been removed from the primary testing phases 1 and 2 in order to focus on the behavior of the vertical mullion and connection elements. In practice, all parts of the composite assembly are important; however the measurement results from the separated elements are to be compared with the composite glass curtain wall system in Phase 3.
2. Vertical flanking paths are not analyzed. Although similar principles regarding the acoustic treatment of the junction between the slab and curtain wall apply, no laboratory tests or analysis are conducted.
3. Materials used in these test measurements are selected based on standard assemblies used in practice today, i.e. material used at the mullion infill or overclad.
4. The IGU assembly in Phase 3 includes a laminated pane; the PVB interlayer is between surface #3 and #4. Flexural vibration through the laminated pane may differ to a monolithic pane and influence the transmission loss performance.
5. Choices available to set the specimen flush with one side of filler wall or at the center were considered. It was decided to set the mullions at the center of the filler wall for two reasons: to continue from the Enclos Corp precedent testing as discussed in Chapter 2 and to simulate a field condition where the mullion is typically centered at a demising wall.
6. Putty and/or wet seal caulking are used to seal the perimeter edges of the specimens during all phases.
7. Pink noise is used at the source chamber.

3.4 LABORATORY RESULT ANALYSIS

Test measurement results obtained through Objective 2 will be used to support Objectives 3 and 4. The laboratory performances will be analytically compared for significant finding between phases and applied to transmission loss predictions for composite conditions with an interconnecting wall.

3.4.1 SOUND TRANSMISSION CORRELATIONS AND COMPARISONS

The test data acquired from the UVM test phases will be analyzed in one-third octave bands to extract significant contributions related the noise reduction (NR) and/or transmission loss. (TL). Sound transmission class (STC) ratings will be identified to categorize the highest and lowest performing assemblies.

3.4.2 COMPOSITE TRANSMISSION LOSS PREDICTIONS

The test data acquired from the UVM test procedure will be applied to composite TL calculation predictions. This composite will include an interior demising wall assembly.

The transmission loss for select curtain wall elements (e.g. mullion, partition connection, glass) will be acquired from testing the specimens at WEAL.

The laboratory transmission loss data for the high performing demising wall partition is obtained from the National Research Council Canada⁶⁴, one of the independent acoustical laboratories that catalog the TL of building materials. As a note, there are other acoustic laboratory institutions around the world that catalogue all types of partition constructions.

The composite transmission loss for the overall building system may be analytically predicted once all Transmission Loss performances are collected.

Composite TL Equation

The composite transmission loss of a non-homogeneous wall may be estimated with the following equation.

$$TL_{Ave} = 10 \log \left(\frac{\sum S_i}{\sum S_i 10^{-\frac{T_i}{10}}} \right)$$

T = transmission coefficient

S = Surface Area

Equation 3-1: Composite
Transmission Loss ⁶⁵⁶⁶

⁶⁴ R.E. Halliwell et al., "NRC-CNRC Gypsum Board Walls: Transmission Loss Data," Internal Report (Canada: Institute for Research in Construction, March 1998), <http://archive.nrc-cnrc.gc.ca/obj/irc/doc/pubs/ir/ir761/ir761.pdf>.

⁶⁵ David A. Bies and Colin H. Hansen, *Engineering Noise Control: Theory and Practice* (Taylor & Francis, 2009).

⁶⁶ Peter Hubert Parkin, Henry Robert Humphreys, and J.R. Cowell, *Acoustics, Noise, and Buildings*, Fourth Edition (Faber and Faber, Boston MA, 1979).

CHAPTER 4 TEST RESULTS AND ANALYSIS OF THE UNITIZED VERTICAL MULLION MEASUREMENT PHASES

4.1 INTRODUCTION

This chapter provides the laboratory measurement results of the unitized vertical mullion (UVM) test method conducted between May 2013 and March 2014 at four different stages:

1. UVM test phase 1: May 2013
2. UVM test phase 2:
 - A. July 2013
 - B. October 2013
3. UVM test phase 3: March 2014

The outline of each section will include the following information (Table 4-1):

1. Phase specific laboratory test set up description
2. Test specimen description, acoustic modifications of materials, and configuration
3. Tabulated STC results for each test specimen per phase (one-third octave band sound transmission loss spectrum results can be found in *Appendix B UVM Laboratory Test*)
4. Transmission loss overlays of significant test specimen comparisons
5. Summaries of notable observations at each test phase, field notes and considerations for future explorations

TEST PHASE	CHAPTER SECTION	MEASURED SPECIMENS (CONNECTED AND UNCONNECTED)			ACOUSTIC METRIC
		Mullion	Connection	Glass Infill	
PHASE 1	Ch 4: 4.2	●			Sound transmission class (STC) ratings One-third octave band sound transmission loss (per center at frequency range 63 Hz –5000 Hz)
PHASE 2A	Ch 4: 4.3	●	●		
PHASE 2B	Ch 4: 4.4		●		
PHASE 3	Ch 4: 4.5	●		●	Vibration acceleration level (dB re 10 ⁻⁶ G) measurements
PHASE 3	Ch 6	●		●	

TABLE 4-1: TEST PHASE OUTLINE OF DATE, UVM, AND RESULTS

4.2 PHASE 1 – MULLION ELEMENT (ISOLATED)

This laboratory test phase measures the TL performance of the vertical mullion (Figure 4-1). The mullion is modified with test variables including infill and overclad materials and measured in the absence of a partition connection or glazing element. Specific configuration descriptions are provided in the following sections. A total of 22 laboratory measurements were conducted.

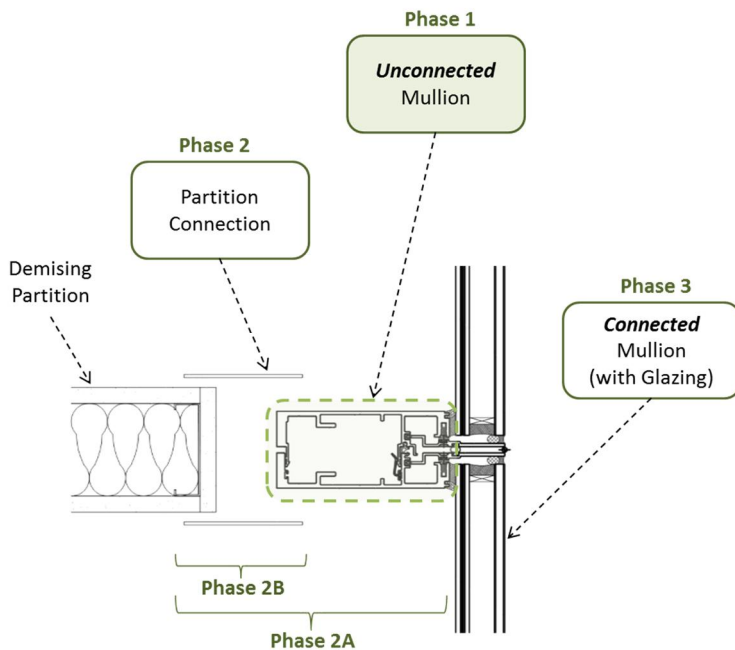

Date May 28, 30, 31, 2013

Laboratory: WEAL

Specimen: Vertical unitized mullion element; connection and glazing element not included

Dimensions: 3" x 6-3/4" x 60" (76 mm x 171mm x 152mm)

Surface Area: 2.71 ft² (0.25m²)

Transmission: Horizontal

Procedure: ASTM E90-09

Total Tests: 22

FIGURE 4-1: PHASE 1: PLAN DIAGRAM OF UVM ELEMENTS AND ASSOCIATED TEST PHASES

4.2.1 PHASE 1 SPECIMEN AND TEST CHAMBER DESCRIPTION

The aluminum mullion profile illustrates how the hollow air cavity is divided in plan by the interstitial leg stiffener connections (Figure 4-2). The various fill materials used for mullion modifications were placed in the larger air cavity. The fill materials of various densities included sand, mineral wool, pea gravel, and damping materials. The materials used to overclad the mullion also consisted of various densities such as gypsum wall board, steel plates, and vinyl damping materials. These were adhered or appended to the 6-3/4" face of the mullion.

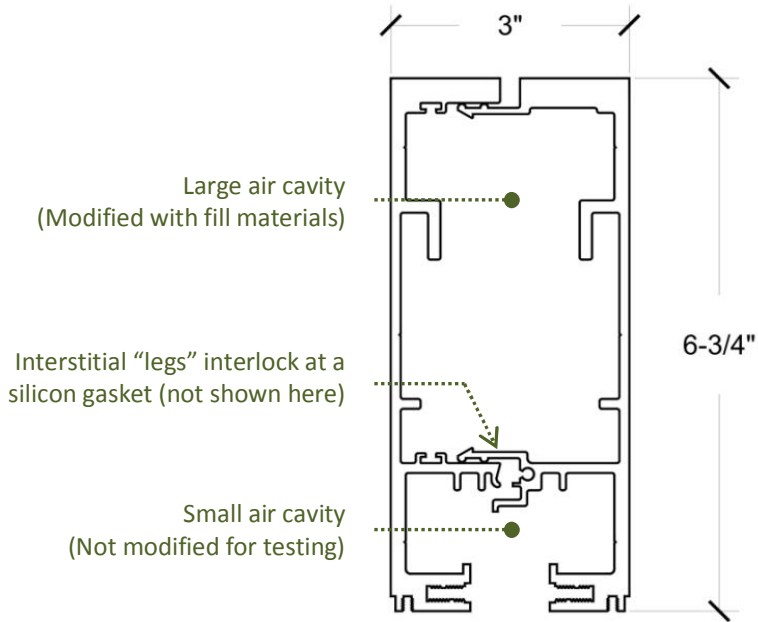

FIGURE 4-2: PLAN DRAWING OF UNITIZED VERTICAL MULLION PROFILE

A photograph of the vertical mullion profile taken at the laboratory is shown (Figure 4-3).

The silicone gasket is present between the interstitial mullion leg stiffeners. A wooden spacer was placed at either end of the mullion cavity to maintain an overall width of 3" as would be the case *in situ*.

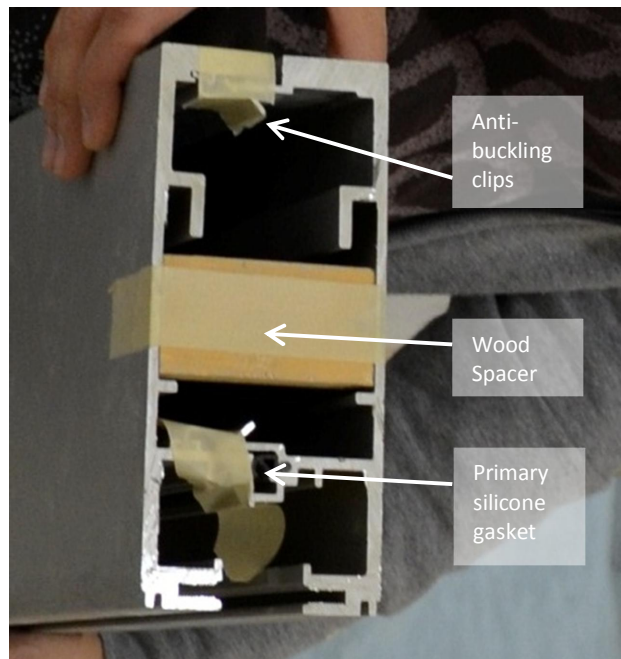

FIGURE 4-3: IMAGE OF HOLLOW EXPOSED MULLION PROFILE WITH ANTI-BUCKLING CLIPS, WOOD SPACES AND SILICONE GASKET

All specimens sat on a neoprene spacer and the perimeter edge gap was sealed with backer rod and putty (Figure 4-4, FIGURE 4-5, and FIGURE 4-6).



FIGURE 4-4: IMAGE OF HOLLOW EXPOSED MULLION PROFILE WITH ANTI-BUCKLING CLIPS, WOOD SPACES AND SILICONE GASKET



FIGURE 4-5: A 1/4" GAP BETWEEN MULLION PERIMETER AND FILLER WALL



FIGURE 4-6: PUTTY APPLIED TO SPECIMEN PERIMETER EDGE TO SEAL ACOUSTIC LEAKS

The test specimen was placed into an aperture in the chamber filler wall with a face area dimension of 60-1/2" x 6-1/2" (Figure 4-7). This allowed a 1/4" perimeter airspace between the specimen and the filler wall to avoid direct contact with each other.



FIGURE 4-7: ELEVATION OF THE MULLION IN THE FILLER WALL WITH SEALED PUTTY PERIMETER

4.2.2 TESTING CLASSIFICATIONS

The modifications to the unitized vertical mullion were categorized into three measurement classes:

Mullion Class A – Exposed and hollow mullion (test constant)

Mullion Class B – Cavity filled mullion tests

Mullion Class C – Overclad mullion tests (with a combination of fill material) The Class C test series was further subdivided based on the overclad material type:

- **C1** aluminum + MLV layer,
- **C2** gypsum board + MLV layer,
- **C3** gypsum board, and
- **C4** aluminum tubes.

All the overclad materials were screwed to the mullion, not glued.

4.2.3 MATERIAL DESCRIPTIONS

Mullion Cavity Fill Materials

Material	Description
mineral wool	2 pcf
sand	Filled in small plastic bags and laid in the mullion cavity
pea gravel	Approximately ¼" diameter, small plastic bags were filled with pea gravel and laid in the mullion cavity
Mass-loaded vinyl (MLV) pillows	2 layers of MLV material (3/16") thick, arched side to side in the mullion cavity, with mineral wool packed in the remaining air gap

Overclad Materials:

Material	Description
Aluminum tube	1-1/2" (16 mm) aluminum tube (1/8" thick with 1-1/4" airspace) ¼" RSIC isolator
Gypsum Wall Board	5/8" thick
Steel Plate	1/8" thick
MLV	3/16" layer

No tests were conducted where a damping compound was attached to the inboard walls of the mullion. Compounds were attached only to the outboard walls.

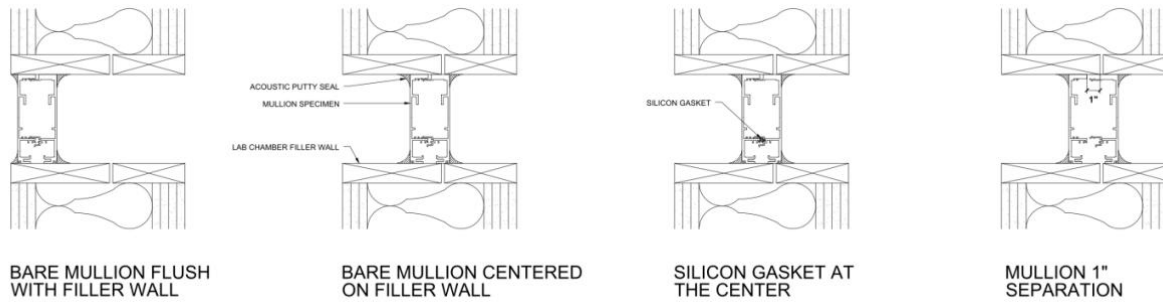

FIGURE 4-8: CLASS A – MULLION (HOLLOW AND EXPOSED)

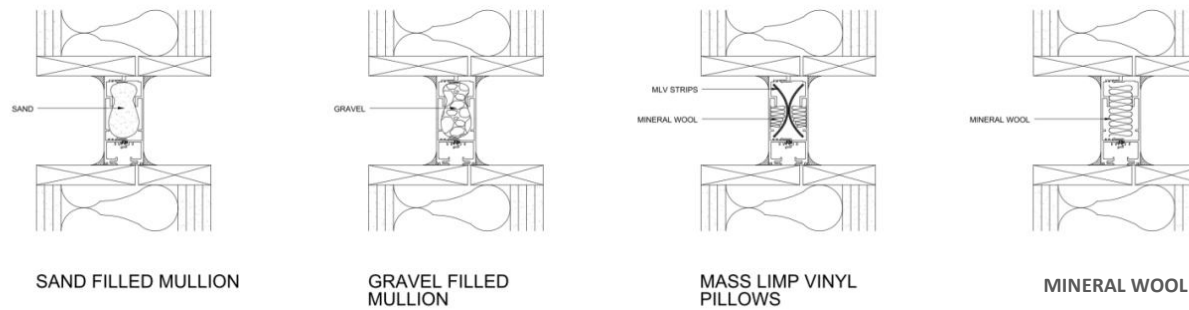

FIGURE 4-9: CLASS B – FILLED MULLIONS

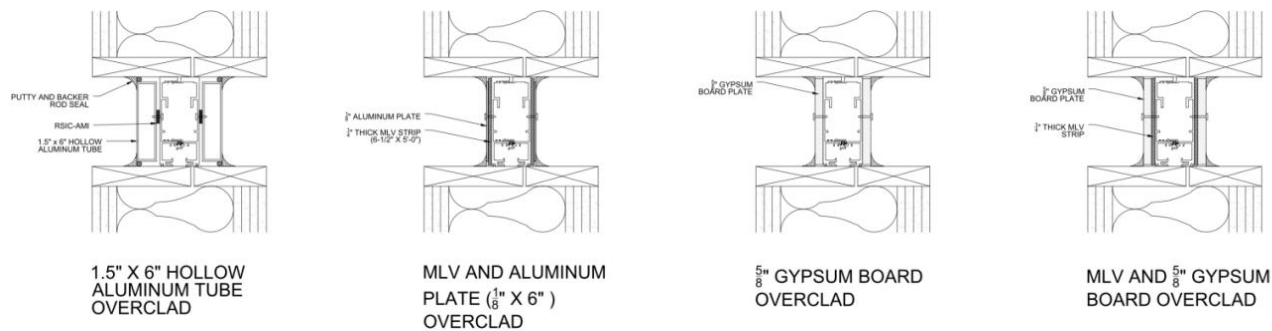

FIGURE 4-10: CLASS C – OVERCLAD MULLIONS

4.2.4 PHASE 1 CLASS A TEST SEQUENCE

Class A mullion test results (HOLLOW AND EXPOSED MULLION) (Table 4-2).

WEAL Test No.	STC	Material Layers [description]	Element Drawing [Plan]
(1) TL13-309	37	[1] 1/8" (3mm) aluminum mullion [2] 2-3/4" (70mm) air space [3] 1/8" (3mm) aluminum mullion [mullion is flush with source room side] [silicone gasket is not included]	
(2) TL13-310	34	[1] 1/8" (3mm) aluminum mullion [2] 2-3/4" (70mm) air space [3] 1/8" (3mm) aluminum mullion [mullion is centered in the filler wall] [silicone gasket is not included]	
(3) TL13-311	36	[1] 1/8" (3mm) aluminum mullion [2] 2-3/4" (70mm) air space [3] 1/8" (3mm) aluminum mullion [silicone gasket is included] [mullion test constant]	
(4) TL13-312	47	[1] 1/8" (3mm) aluminum mullion [2] 3-3/4" (95 mm) air space [3] 1/8" (3mm) aluminum mullion [mullion leaves disconnected by 1" (25mm)]	

TABLE 4-2: PHASE 1 CLASS A, STC RESULTS, AND SPECIMEN DESCRIPTION

The goal of this mullion test series was to determine the effect of the position on the transmission loss. It was decided that all mullion positions should be located at the center of the filler wall to simulate a centered condition *in situ* with a demising wall. Other laboratories test specimens that are flush to one side of the chamber wall, but that was not the choice for this case.

4.2.4.1 PHASE 1-A DEDUCTIONS AND OBSERVATIONS

Test specimen TL13-311 is identified as one of the base cases and applied to variable conditions in subsequent test measurements. It is considered the minimum base case performance and used for measurement comparisons in other phases.

TL13-312 was conducted to understand the acoustic impact of a 2-leaf system without interconnections. This mullion does not have a practical use when completely separated in this way because the stability of the system is compromised. Further development of this is conducted in Phase 2B.

The TL spectra of the mullions in Phase 1 Class A include

- Lowest STC: (2) TL13-310, STC 34
- Highest STC: (4) TL13-312, STC 47

Mullion specimen TL13-309 is located in the filler wall flush against the source side of the room and has a resonance at 160 Hz. TL13-311 (test constant) is centered in the filler wall and has a resonance at 400 Hz (Figure 4-11).

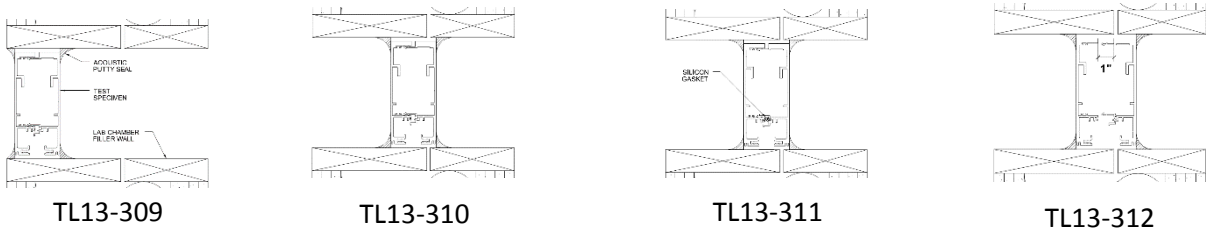
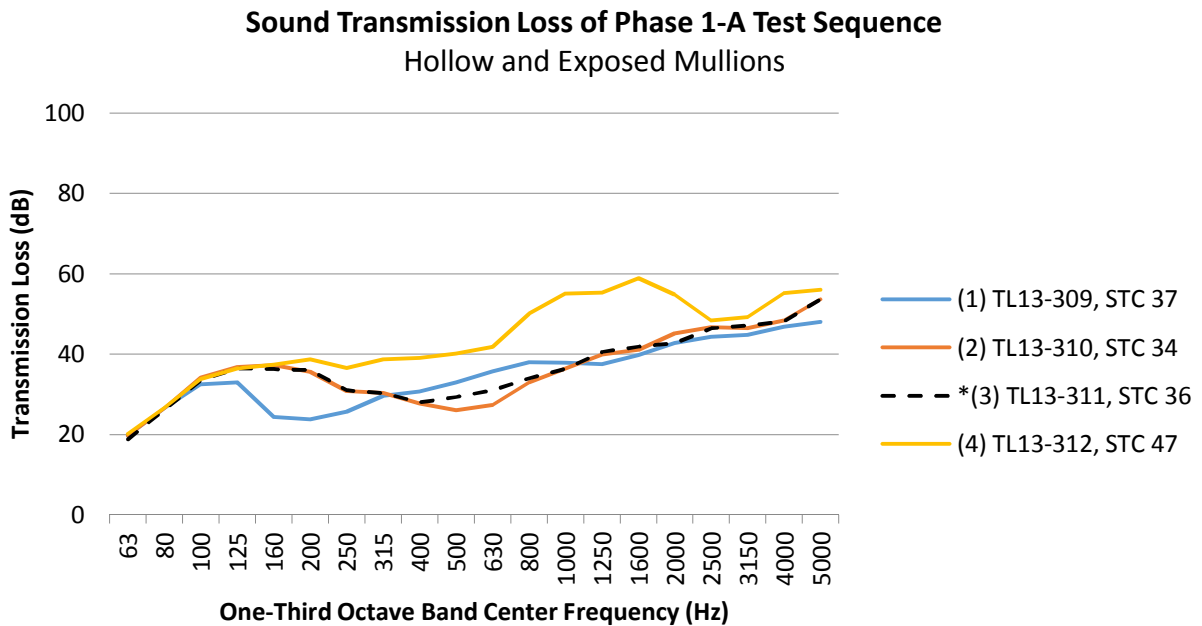

FIGURE 4-11: PHASE 1-A TRANSMISSION LOSS CURVES

*UNTREATED MULLION BASE CASE, MC1

4.2.5 PHASE 1 CLASS B TEST SEQUENCE

Class B mullion test results (MULLION CAVITY FILLED) (Table 4-3).

WEAL Test No.	STC	Material Layers [description]	Element Drawing [Plan]
(5) TL13-313	39	<p>[1] 1/8" (3mm) aluminum mullion [2] 2-3/4" (70mm) pea gravel [3] 1/8" (3mm) aluminum mullion</p> <p>[specimen weight is 49.5 lbs (22.5 kg)]</p>	
(6) TL13-314	38	<p>[1] 1/8" (3mm) aluminum mullion [2] 2-3/4" (70mm) sand [3] 1/8" (3mm) aluminum mullion</p> <p>[specimen weight is 45.5 lbs (20.6 kg)]</p>	
(7) TL13-315	36	<p>[1] 1/8" (3mm) aluminum mullion [2] 2-3/4" (70mm) mineral fiber 2.5 pcf [3] 1/8" (3mm) aluminum mullion</p> <p>[mineral fiber 2.5 pcf (40 kg/m³)] [mineral fiber laid in, not ram packed]</p>	
(8) TL13-316	38	<p>[1] 1/8" (3mm) aluminum mullion [2] 2-3/4" (70mm) MLV pillow [3] 1/8" (3mm) aluminum mullion</p> <p>[specimen weight is 34.5 lbs (20.6 kg)]</p>	

TABLE 4-3: PHASE 1 CLASS B, STC RESULTS, AND SPECIMEN DESCRIPTION

(5) TL13-313	(6) TL13-314	(7) TL13-315	(8) TL13-316
39	38	36	38
			



FIGURE 4-12: CLASS B FILLED MULLION (A) PEA GRAVEL (B) SAND (C) MINERAL WOOL (D) MLV PILLOWS

4.2.6.1 PHASE 1-B DEDUCTIONS AND OBSERVATIONS

The highest performing mullions in Class B is TL13-313, filled with pea gravel and TL13-316, filled with MLV pillows. These fill materials are used for measurements in the next sequence of measurements, Class C. Additionally these fill configurations are understood to be cost effective and practical.

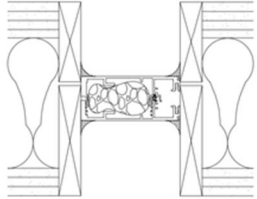
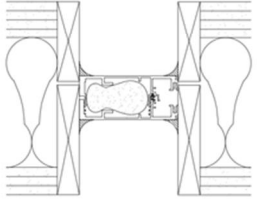
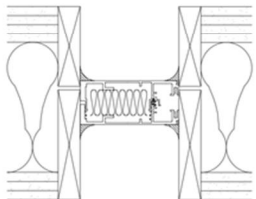
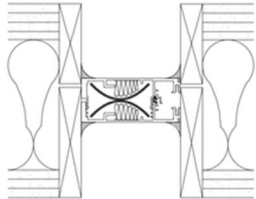
The TL spectra of mullions in Phase 1 Class B are shown include (Figure 4-13):

- Lowest STC: (7) TL13-315, STC 36
- Highest STC: (5) TL13-313, STC 39

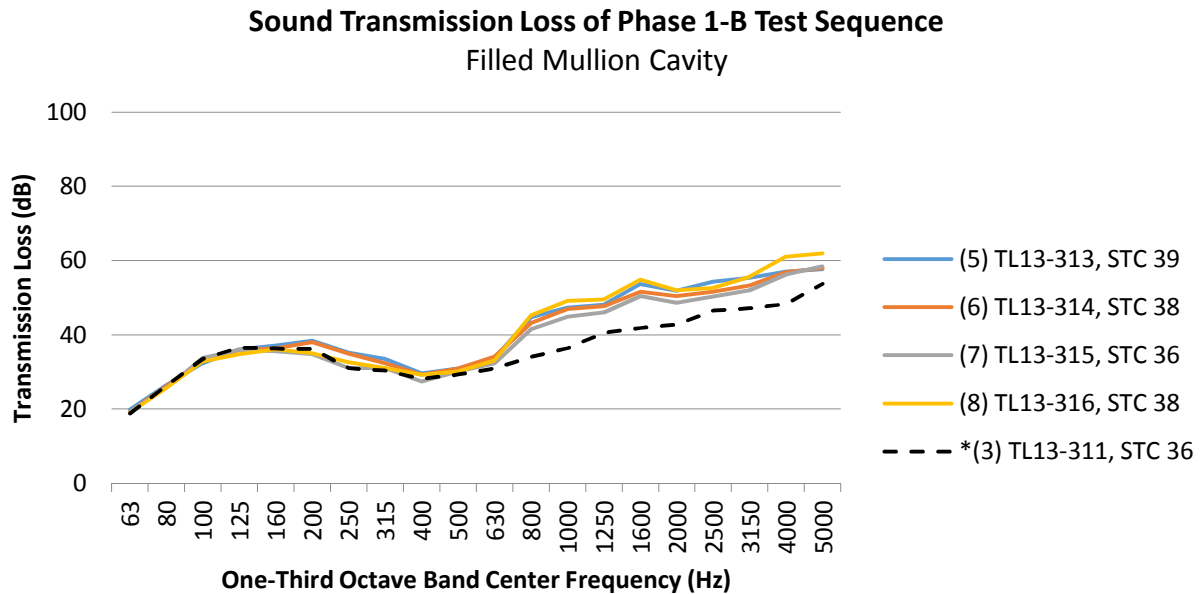

FIGURE 4-13: PHASE 1-B TRANSMISSION LOSS CURVES

*UNTREATED MULLION BASE CASE, MC1

There are several observations that can be drawn with reference to Figure 4-13 and Table 4-4:

- Mullion infill provides up to a +6 STC dB point average increase compared to TL13-311.
- There is a +3dB variation between material fill variations when comparing the maximum and minimum TL values.
- The standard deviation between Class B tests #5 - #8 indicate a 1 – 2 STC dB point change depending on the mullion fill.
- There is a 3 to 5 STC dB standard deviation between Class B tests #5 - # 8 and TL13-311 between the 800 Hz to 5 kHz frequency range.
- The mullion cavity infill provides significant TL improvement above 800Hz when compared to TL13-311.
- The transmission loss results of Class B show a significant improvement at 630 Hz to 5000 Hz in comparison to the MC-1 frequency spectrum.

	Class B Standard Deviation																			
	One-third Octave Band Center Frequency (Hz)																			
	63	80	100	125	160	200	250	315	400	500	630	800	1k	1.25k	1.6k	2000	2.5k	3.15k	4k	5k
Class B tests	0.4	0.5	0.6	0.6	0.6	1.9	2.0	1.2	1.0	0.5	0.8	1.7	1.8	1.5	2.0	1.6	1.7	1.8	2.2	2.0
Class B tests and TL13-311	0.4	0.4	0.6	0.7	0.5	1.7	2.0	1.3	0.9	0.6	1.2	4.5	5.0	3.5	5.1	3.8	2.9	3.4	4.6	2.9

TABLE 4-4: CLASS B STANDARD DEVIATION

The following images are indicative of the overlaid typologies used at each Class C variation:

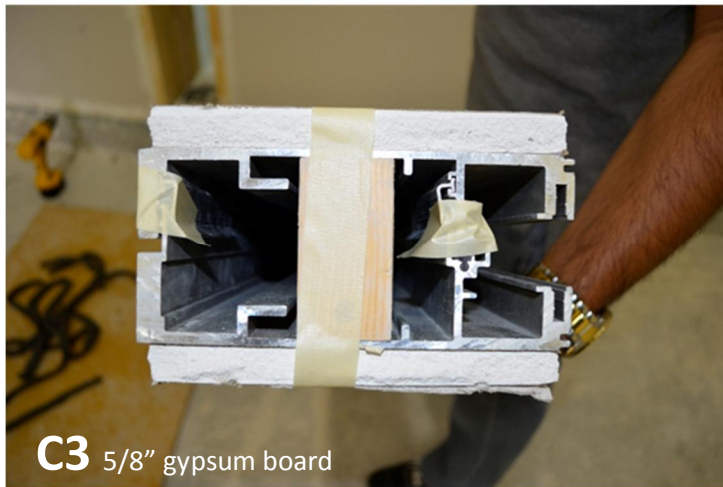
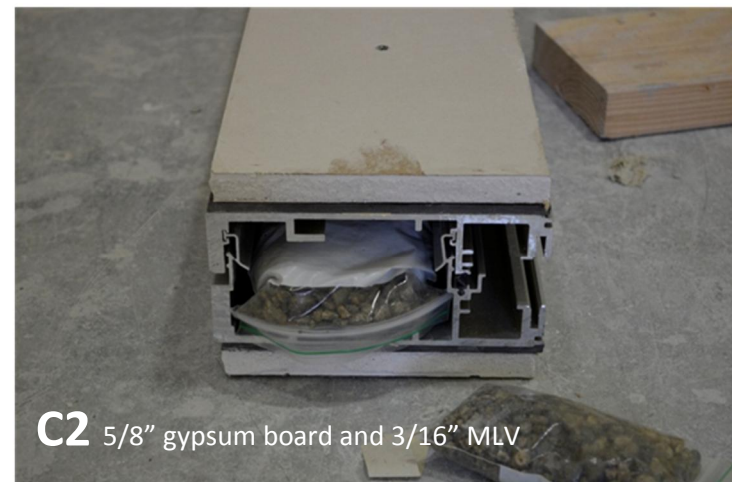

FIGURE 4-14: CLASS C OVERCLAD MULLION IMAGES FROM TEST SERIES C1, C2, C3, AND C4

4.2.7 PHASE 1 CLASS C1 TEST SEQUENCE

Class C1 mullion test results [1/8" ALUMINUM PLATE PLUS 3/16" MASS LIMP VINYL LAYER OVERCLAD] (Table 4-5).

WEAL Test No.	STC	Material Layers [description]	Element Drawing [Plan]
(9) TL13-317	46	<ol style="list-style-type: none"> [1] 1/8" (3mm) aluminum plate [2] 3/16" (5 mm) MLV layer [3] 1/8" (3mm) aluminum mullion [4] 2-3/4" (70mm) MLV pillow [5] 1/8" (3mm) aluminum mullion [6] 3/16" (5 mm) MLV layer [7] 1/8" (3mm) aluminum plate <p>[specimen weight is 54 lbs (24.5 kg)]</p>	
(10) TL13-318	48	<ol style="list-style-type: none"> [1] 1/8" (3mm) aluminum plate [2] 3/16" (5 mm) MLV layer [3] 1/8" (3mm) aluminum mullion [4] 2-3/4" (70mm) air space [5] 1/8" (3mm) aluminum mullion [6] 3/16" (5 mm) MLV layer [7] 1/8" (3mm) aluminum plate <p>[specimen weight is 45.25 lbs (20.5 kg)]</p>	
(12) TL13-320	46	<ol style="list-style-type: none"> [1] 1/8" (3mm) aluminum plate [2] 3/16" (5 mm) MLV layer [3] 1/8" (3mm) aluminum mullion [4] 2-3/4" (70mm) pea gravel [5] 1/8" (3mm) aluminum mullion [6] 3/16" (5 mm) MLV layer [7] 1/8" (3mm) aluminum plate <p>[specimen weight is 69 lbs (31 kg)]</p>	

TABLE 4-5: PHASE 1 CLASS C1, STC TEST RESULTS AND SPECIMEN DESCRIPTION

4.2.7.1 PHASE 1-C1 DEDUCTIONS AND OBSERVATIONS

The TL spectra of mullions in Phase 1 Class C1 (Figure 4-15) include

- Lowest performing STC: (9) TL13-317, STC 46
(12) TL13-320, STC 46
- Highest performing STC: (10) TL13-318, STC 48
(11) TL13-319, STC 48

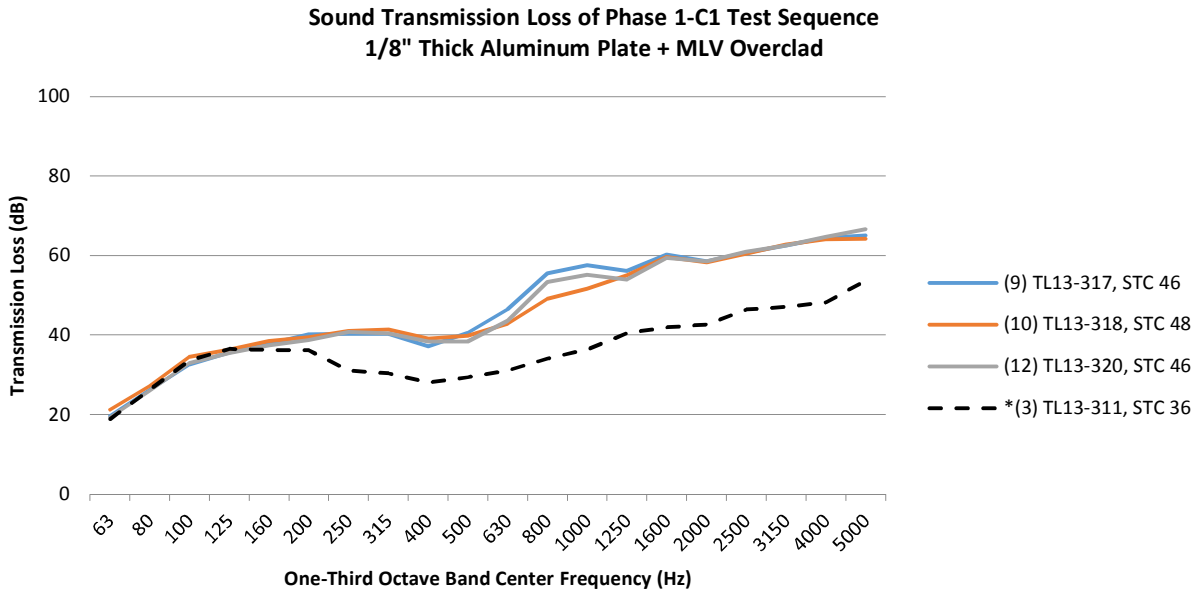

FIGURE 4-15: PHASE 1-B TRANSMISSION LOSS CURVES

*UNTREATED MULLION BASE CASE, MC1

There are several observations that can be drawn with reference to Figure 4-15 and Table 4-6:

- TL13-318 performed 2dB STC points higher than TL13-317 although the mullion cavity is hollow, which reduced the overall mass of the specimen.
- The overclad in this series (aluminum and MLV) provides up to a 14dB STC increase compared to a hollow exposed mullion.
- Composite variations of mullion cavity infill with the overclad provide a 2dB STC improvement
- The overclad provides significant improvement above 250 Hz.
- TL13-318 (hollow cavity) has more than a 5 dB TL reduction at 800Hz and 1 kHz compared to TL13-317 and TL13-320 which have filled mullion cavities.
- Class C1 test measurements improved over 10dB TL across the frequency ranges above 250 Hz compared to TL13-311 mullion constant.
- The standard deviation within the Class C1 measurement tests 9-12 is 1 dB – 3 dB across all frequencies.
- The standard deviation between Class C1 (tests 9-12) and TL13-311 is 4 dB -8 dB at the 250 Hz to 5 kHz frequency range.

	Class C1 Standard Deviation																			
	One-third Octave Band Center Frequency (Hz)																			
	63	80	100	125	160	200	250	315	400	500	630	800	1k	1.25k	1.6k	2000	2.5k	3.15k	4k	5k
Class C1 tests	0.9	0.5	0.8	0.4	0.5	0.6	0.3	0.5	0.9	0.9	1.7	3.2	2.8	0.9	0.4	0.2	0.2	0.1	0.4	1.3
Class C1 tests and TL13-311	0.9	0.4	0.7	0.5	0.8	1.5	4.3	4.7	4.7	4.7	5.9	8.4	8.3	6.5	7.9	7.0	6.3	6.9	7.1	5.1

TABLE 4-6: CLASS C1 STANDARD DEVIATION

4.2.8 PHASE 1 CLASS C2 TEST SEQUENCE

Class C2 mullion test results [5/8" GYPSUM BOARD PLATE PLUS 3/16" MASS LIMP VINYL PLATE OVERCLAD] (Table 4-7).

WEAL Test No.	STC	Material Layers [description]	Element Drawing (Plan)
(13) TL13-321	50	<ol style="list-style-type: none"> [1] 5/8" (16 mm) gypsum board plate [2] 3/16" (5 mm) MLV layer [3] 1/8" (3mm) aluminum mullion [4] 2-3/4" (70mm) air space [5] 1/8" (3mm) aluminum mullion [6] 3/16" (5 mm) MLV layer [7] 5/8" (16 mm) gypsum board plate <p>[specimen weight is 49.5 lbs (22.5 kg)]</p>	
(14) TL13-322	47	<ol style="list-style-type: none"> [1] 5/8" (16 mm) gypsum board plate [2] 3/16" (5 mm) MLV layer [3] 1/8" (3mm) aluminum mullion [4] 2-3/4" (70mm) pea gravel [5] 1/8" (3mm) aluminum mullion [6] 3/16" (5 mm) MLV layer [7] 5/8" (16 mm) gypsum board plate <p>[specimen weight is 72.5 lbs (33 kg)]</p>	
(15) TL13-323	52	<ol style="list-style-type: none"> [1] 5/8" (16 mm) gypsum board plate [2] 3/16" (5 mm) MLV layer [3] 1/8" (3mm) aluminum mullion [4] 2-3/4" (70mm) MLV pillows [5] 1/8" (3mm) aluminum mullion [6] 3/16" (5 mm) MLV layer [7] 5/8" (16 mm) gypsum board plate <p>[specimen weight is 57.5 lbs (26 kg)]</p>	

TABLE 4-7: PHASE 1 CLASS C2, STC TEST RESULTS AND SPECIMEN DESCRIPTION

4.2.8.1 PHASE 1-C2 DEDUCTIONS AND OBSERVATIONS

The TL spectra of mullions in Phase 1 Class C2 (Figure 4-16) include

- Lowest performing STC: (14) TL13-322, STC 47
- Highest performing STC: (15) TL13-323, STC 52

TL13-323 is the highest performing test in the Phase 1 series and is used as the second test constant for subsequent testing Phases.

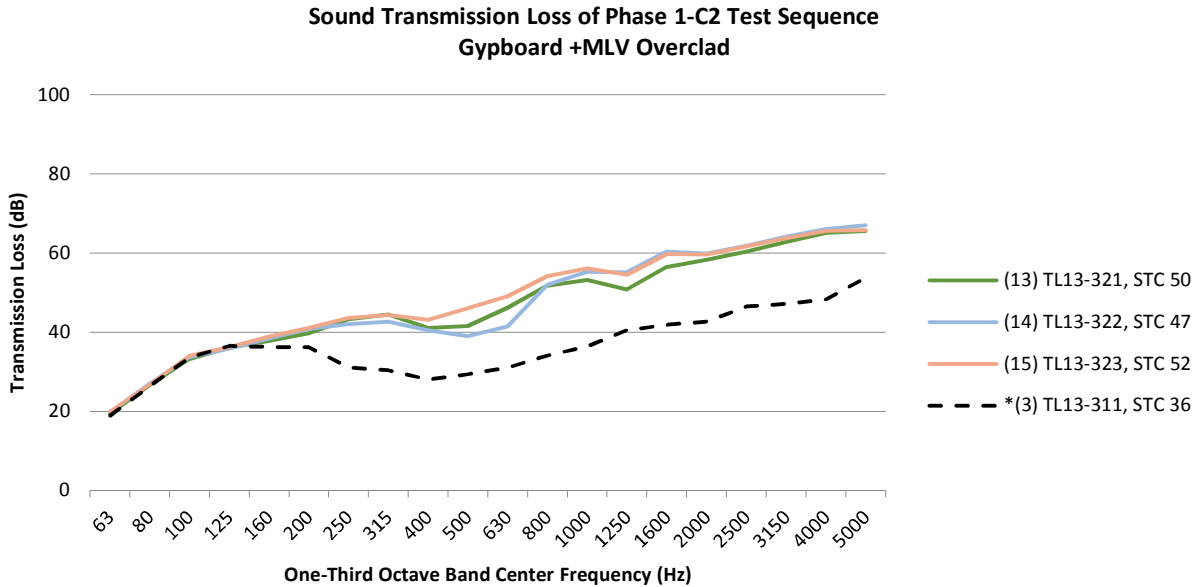

FIGURE 4-16: PHASE 1-C2 TRANSMISSION LOSS CURVES

*UNTREATED MULLION BASE CASE, MC1

There are several observations that can be drawn with reference to Figure 4-16 and Table 4-8:

- It is unclear why TL13-322 (including a pea gravel mullion fill) performs lower than TL13-321 (hollow mullion cavity) even though the former includes additional mass.
- TL13-321 in this test series performs 2 dB STC points higher than TL13-318 from the last test series C1. The difference may be attributed to the difference in overclad mass as both mullion have hollow cavities. The mass of the gypsum board overclad is heavier than the aluminum plate overclad in the last series.
- In general, the overclad of gypsum board + MLV provides up to a 15dB STC increase when compared to TL13-311 (hollow and exposed mullion).
- Class C2 tests provide a 10 dB improvement across the 250 Hz to 5 kHz frequency region.

	Class C2 Standard Deviation																			
	One-third Octave Band Center Frequency (Hz)																			
	63	80	100	125	160	200	250	315	400	500	630	800	1k	1.25k	1.6k	2000	2.5k	3.15k	4k	5k
Class C2 tests	0.3	0.3	0.4	0.2	0.5	0.7	0.8	1.0	1.4	3.6	3.9	1.3	1.5	2.4	2.1	0.9	0.8	0.7	0.5	0.8
Class C2 tests and TL13-311	0.5	0.3	0.3	0.3	1.1	2.3	6.0	6.8	6.8	7.0	7.9	9.3	9.3	6.7	8.6	8.3	7.4	8.2	8.6	6.2

TABLE 4-8: CLASS C2 STANDARD DEVIATION

- The standard deviation within the Class C2 tests 13-15 is 1 dB - 3dB across one-third octave band center frequencies, with the exception of 500 Hz and 630 Hz.

- The standard deviation between Class C2 tests 13-15 and TL13-311 is 6 dB – 9 dB from the 250 Hz to 5 kHz frequency region.

4.2.9 PHASE 1 CLASS C3 TEST SEQUENCE

Class C3 mullion test results [5/8" GYPSUM BOARD PLATE OVERCLAD] (Table 4-9).

WEAL Test No.	STC	Material Layers [description]	Element Drawing (Plan)
(16) TL13-324	47	[1] 5/8" (16 mm) gypsum board plate [2] 1/8" (3mm) aluminum mullion [3] 2-3/4" (70mm) MLV pillows [4] 1/8" (3mm) aluminum mullion [5] 5/8" (16 mm) gypsum board plate [specimen weight is 47 lbs (21 kg)]	 <p>The drawing shows a cross-section of a mullion assembly. It features two 5/8" gypsum board plates on either side of a central mullion. The mullion consists of two 1/8" aluminum mullions with 2-3/4" MLV pillows in between. Labels include 'MLV PILLOWS' and '5/8" GYPSUM BD'.</p>
(17) TL13-325	42	[1] 5/8" (16 mm) gypsum board plate [2] 1/8" (3mm) aluminum mullion [3] 2-3/4" (70mm) air space [4] 1/8" (3mm) aluminum mullion [5] 5/8" (16 mm) gypsum board plate	 <p>The drawing shows a cross-section of a mullion assembly. It features two 5/8" gypsum board plates on either side of a central mullion. The mullion consists of two 1/8" aluminum mullions with 2-3/4" air space in between. A label indicates '5/8" GYPSUM BD'.</p>
(18) TL13-326	45	[1] 5/8" (16 mm) gypsum board plate [2] 1/8" (3mm) aluminum mullion [3] 2-3/4" (70mm) pea gravel [4] 1/8" (3mm) aluminum mullion [5] 5/8" (16 mm) gypsum board plate [specimen weight is 61.5 lbs (28 kg)]	 <p>The drawing shows a cross-section of a mullion assembly. It features two 5/8" gypsum board plates on either side of a central mullion. The mullion consists of two 1/8" aluminum mullions with 2-3/4" pea gravel in between. Labels include 'PEA GRAVEL' and '5/8" GYPSUM BD'.</p>

TABLE 4-9: PHASE 1 CLASS C3, STC TEST RESULTS, AND SPECIMEN DESCRIPTION

4.2.9.1 PHASE 1-C3 DEDUCTIONS AND OBSERVATIONS

The TL spectra of mullions in Phase 1 Class C3 (Figure 4-17) include

- Lowest performing STC: (17) TL13-325, STC 42
- Highest performing STC: (16) TL13-324, STC 47

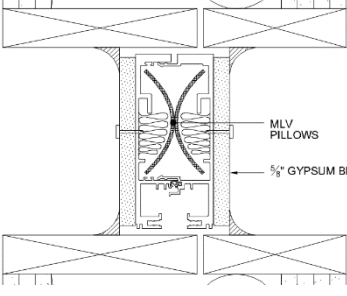
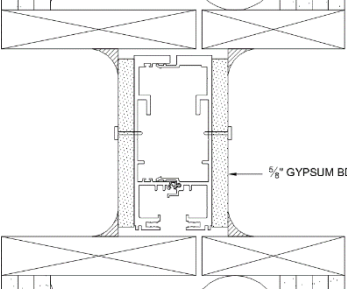
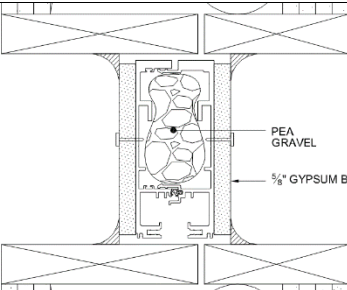
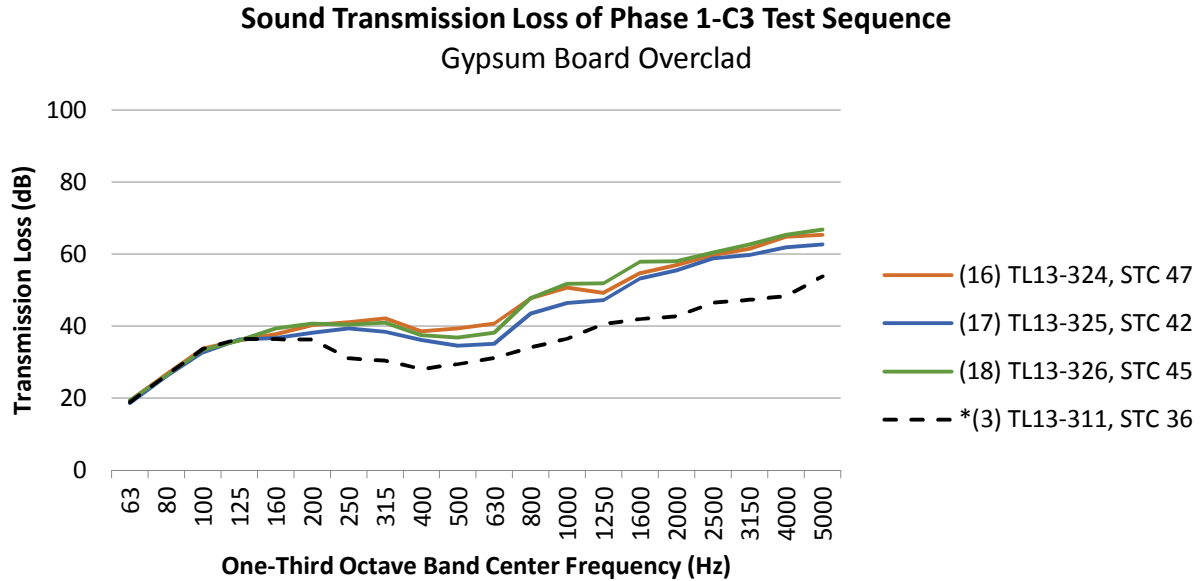

FIGURE 4-17: PHASE 1-C3 TRANSMISSION LOSS CURVES

*UNTREATED MULLION BASE CASE, MC1

There are several observations that can be drawn with reference to Figure 4-17 and Table 4-10:

- The gypsum board overclad provides up to an 11dB STC increase compared to a hollow exposed mullion, TL13-311.
- There is 3dB STC between material variations in the mullion cavity
- The performance of the Class C3 test sequence is greater than 5 dB compared to TL13-311 from the 250 Hz – 5 kHz frequency region.
- The standard deviation within Class C3 tests 16-18 is 1 dB - 3dB across all frequencies.
- The standard deviation within Class C3 tests 16-18 and TL13-311 is 5 dB – 8 dB from the 250 Hz to 5 kHz frequency region.

	Class C3 Standard Deviation																			
	One-third Octave Band Center Frequency (Hz)																			
	63	80	100	125	160	200	250	315	400	500	630	800	1k	1.25k	1.6k	2000	2.5k	3.15k	4k	5k
Class C3 tests (16-18)	0.4	0.4	0.5	0.1	1.3	1.4	0.8	1.9	1.2	2.4	2.8	2.5	2.8	2.3	2.4	1.2	0.8	1.5	1.9	2.1
Class C3 tests and TL13-311	0.3	0.3	0.5	0.3	1.3	2.1	4.6	5.3	4.7	4.2	4.1	6.4	7.0	4.8	6.9	7.1	6.6	7.1	7.9	5.8

TABLE 4-10: CLASS C3 STANDARD DEVIATION

4.2.10 PHASE 1 CLASS C4 TEST SEQUENCE

Class C4 mullion test results (1-1/2" HOLLOW ALUMINUM TUBE OVERCLAD WITH RESILIENT CONNECTION] (Table 4-11).

WEAL Test No.	STC	Material Layers [description]	Element Drawing (Plan)
(19) TL13-327	31	<ol style="list-style-type: none"> [1] 1-1/2" (16 mm) hollow aluminum tube [2] 1/4" (6mm) airspace RSIC isolator [3] 1/8" (3mm) aluminum mullion [4] 2-3/4" (70mm) air space [5] 1/8" (3mm) aluminum mullion [6] 1/4" (6mm) airspace RSIC isolator [7] 1-1/2" (16 mm) hollow aluminum tube <p>[specimen weight is approximately 47 lbs]</p>	
(20) TL13-328	38	<ol style="list-style-type: none"> [1] 1-1/2" (16 mm) MLV + aluminum tube [2] 1/4" (6mm) airspace RSIC isolator [3] 1/8" (3mm) aluminum mullion [4] 2-3/4" (70mm) air space [5] 1/8" (3mm) aluminum mullion [6] 1/4" (6mm) airspace RSIC isolator [7] 1-1/2" (16 mm) MLV+ aluminum tube <p>[specimen weight is 56.75 lbs (21 kg)]</p>	
(21) TL13-329	48	<ol style="list-style-type: none"> [1] 1-1/2" (16 mm) MLV pillow+ alum tube [2] 1/4" (6mm) airspace RSIC isolator [3] 1/8" (3mm) aluminum mullion [4] 2-3/4" (70mm) air space [5] 1/8" (3mm) aluminum mullion [6] 1/4" (6mm) airspace RSIC isolator [7] 1-1/2" (16 mm) MLV pillow+ alum tube <p>[specimen weight is 58 lbs (26 kg)]</p>	
(22) TL13-330	48	<ol style="list-style-type: none"> [1] 1-1/2" (16 mm) MLV pillow+ alum tube [2] 1/4" (6mm) airspace MLV buttons [3] 1/8" (3mm) aluminum mullion [4] 2-3/4" (70mm) air space [5] 1/8" (3mm) aluminum mullion [6] 1/4" (6mm) airspace MLV buttons [7] 1-1/2" (16 mm) MLV pillow+ alum tube <p>[specimen weight is 58.5 lbs (26.5 kg)]</p>	

TABLE 4-11: PHASE 1 CLASS C4, STC TEST RESULTS AND SPECIMEN DESCRIPTION

4.2.10.1 PHASE 1-C4 DEDUCTIONS AND OBSERVATIONS

The TL spectra of mullions in Phase 1 Class C4 (Figure 4-18) include:

- Lowest performing STC: (19) TL13-327, STC 31
- Highest performing STC: (21) TL13-329, STC 48
(22) TL13-330, STC 48

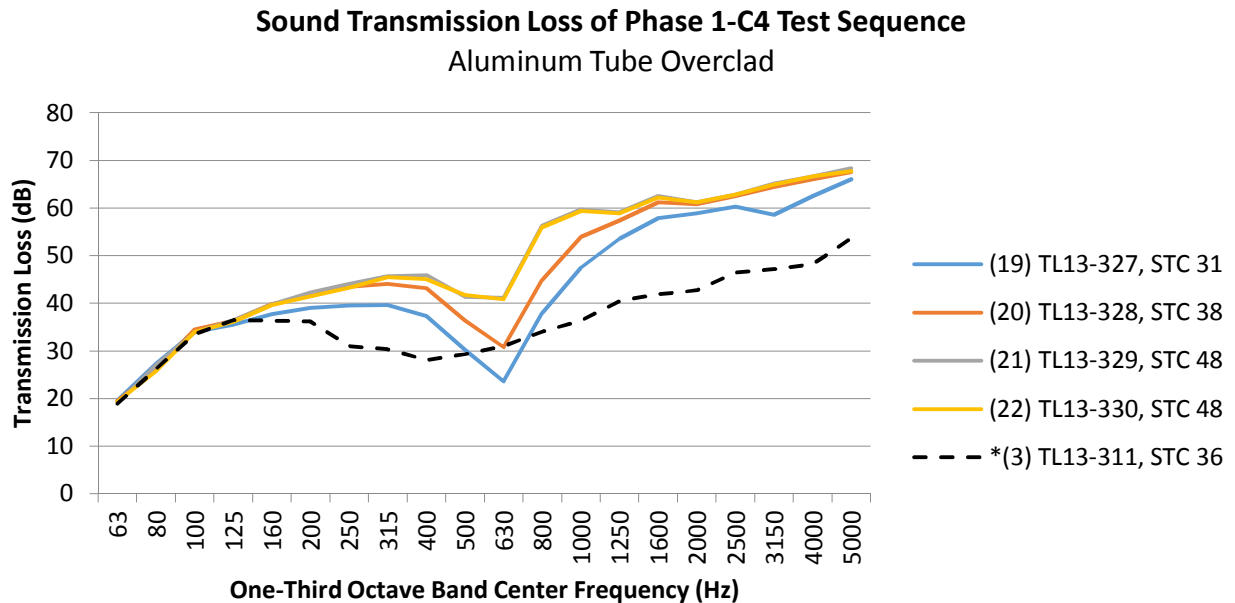

FIGURE 4-18: PHASE 1-C4 TRANSMISSION LOSS

*UNTREATED MULLION BASE CASE, MC1

There are several observations that can be drawn with reference to Figure 4-20 and Table 4-12:

- A significant resonance at 630 Hz is present in all measurements of this C4 test sequence. The acoustic excitation frequency may be the same as the natural frequency of aluminum tube.
- With the exception of 630 Hz, class C4 tests, there is a general TL improvement to the TL13-311 mullion from 250 Hz – 5 kHz.
- The difference between test specimens TL13-327 and TL13-330 is the resilient isolation connection to the aluminum tube overclad, the Pac-International RSIC isolators and MLV buttons respectively. The performance difference between the two tests is negligible.
- The aluminum tube overclad provides up to a 9dB STC increase compared to the TL13-311 hollow exposed mullion. This is a significant improvement, however not as high as previous overclad systems due to the resonance seen at 630Hz that lowers the overall STC rating.
- Infill variations within mullion cavity provide a 3dB STC improvement.
- There is 3dB STC between material variations Class C4 Investigation.
- Standard deviation between Class C4 tests 19-22 is up to 9dB across the frequency spectrum.
- Standard deviation between Class C4 tests 19-22 and TL13-311 is 5 dB – 10 dB at 250 Hz to 5 kHz.

Standard Deviation	Class C4 Standard Deviation																			
	One-third Octave Band Center Frequency (Hz)																			
	63	80	100	125	160	200	250	315	400	500	630	800	1k	1.25k	1.6k	2000	2.5k	3.15k	4k	5k
Class C4 tests (19-22)	0.2	0.8	0.3	0.4	1.0	1.4	2.1	2.8	3.8	5.4	8.5	9.0	5.8	2.6	2.1	1.1	1.2	3.1	2.0	1.0
Class C4 tests and baseline (19-22 & 3)	0.3	0.7	0.3	0.4	1.5	2.5	5.4	6.4	7.4	5.9	7.5	10.1	9.7	7.8	8.7	8.0	7.1	7.7	7.9	6.2

TABLE 4-12: CLASS C4 STANDARD DEVIATION

PAC International® RSIC Clips are compared to C4 tests 19 – 22 (FIGURE 4-19).

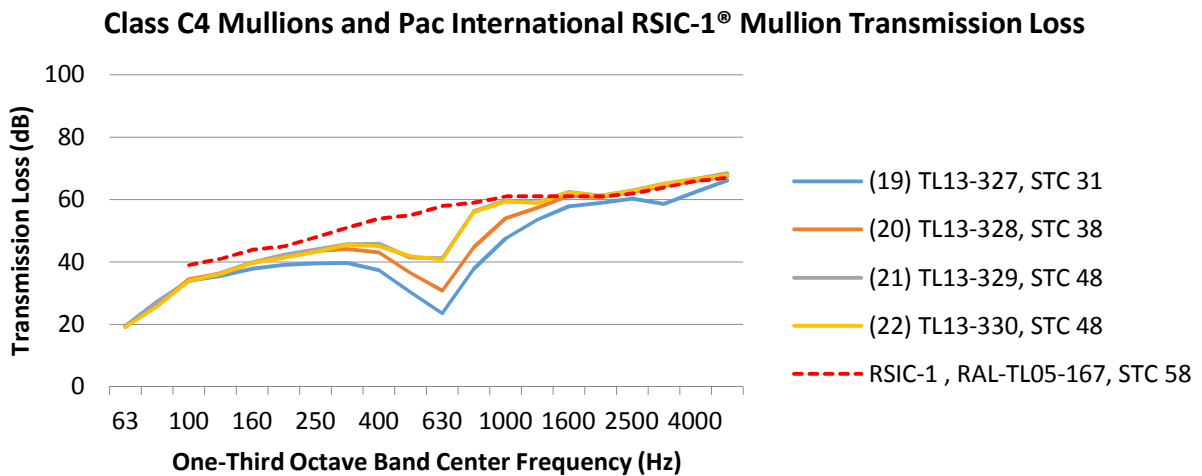

FIGURE 4-19: TRANSMISSION LOSS OVERLAY OF PHASE 1-C4 AND PAC INTERNATIONAL® RSIC SPECIMEN

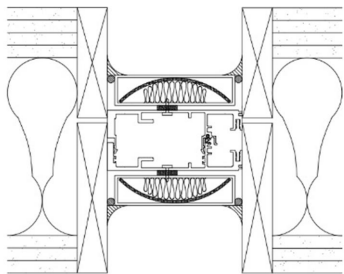

FIGURE 4-20: WEAL TL13-329 STC 48, LAB FILLER WALL STC 74 FILLER WALL

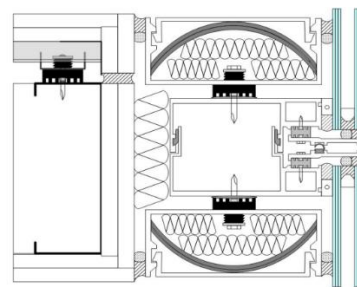

FIGURE 4-21: RAL TL05-167, STC 58, COMPOSITE WALL PARTITION STC 64 © PAC INTERNATIONAL®

Results from the PAC International® test specimen does not indicate the same resonance as the Class C4 specimens. It should be noted that the test specimens are not measured under the same laboratory

conditions. The Phase 1 C4 tests are measured in the absence of a composite partition, and the PAC International® includes an STC 64 wall partition.

4.2.11 PHASE 1 SUMMARY

The transmission loss of all Phase 1 mullions are plotted (FIGURE 4-22).

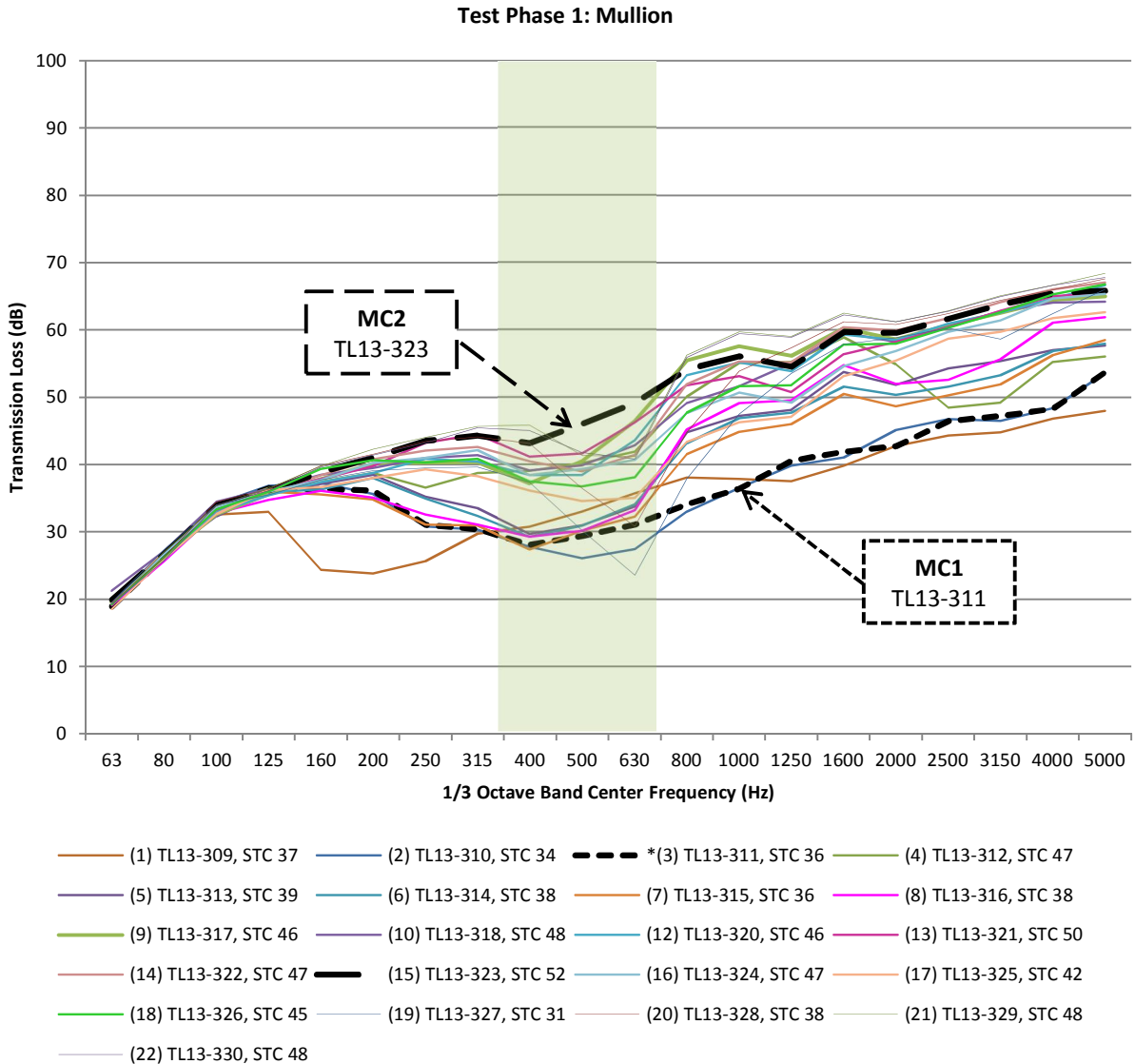

FIGURE 4-22: TRANSMISSION LOSS SPECTRA OF ALL PHASE 1 E90 LABORATORY TESTS

*UNTREATED MULLION BASE CASE, MC1

There is a trend of resonant frequencies between 400 – 630 Hz, common in all Phase 1 test measurements (FIGURE 4-22). Mullion specimens MC 1 (mullion control 1, TL13-311, Figure 4-23) and MC 2 (mullion control 2, TL13-323, Figure 4-24) are identified as the lowest and highest performing mullions to be applied to subsequent phases as a means of comparison.

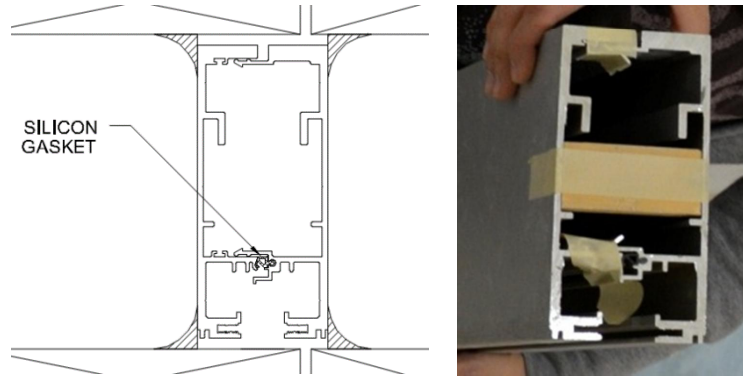

FIGURE 4-23: MULLION CONSTANT 1 (MC1) SHOWN IN PLAN (LEFT) AND SPECIMEN PHOTO (RIGHT)

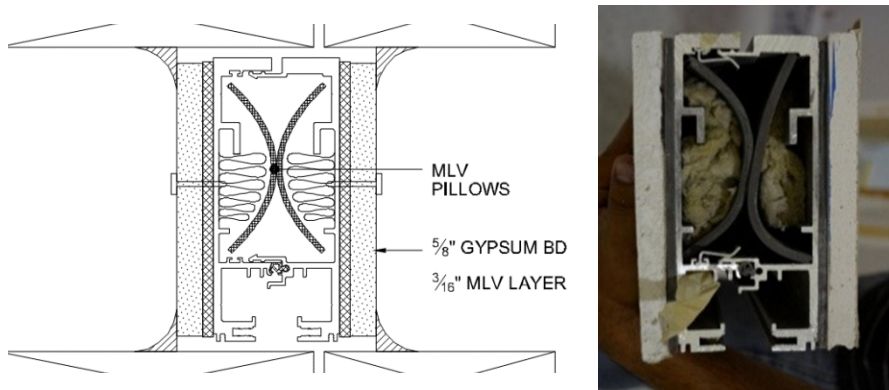

FIGURE 4-24: MULLION CONSTANT 2 (MC2) SHOWN IN PLAN (LEFT) AND SPECIMEN PHOTO (RIGHT)

The lowest performing mullion in Phase 1 was the TL13-327 (STC 31) test specimen. This is not selected as the mullion constant since it includes an atypical modification (aluminum tube overlaid) with an irregular spectrum. The standard deviation between Test #3, and #5 through #22 ranges from 0.4 to 6.6 (Table 4-13).

The table below provides the standard deviation between Test #3, and #5 through #22.

Tests	Phase 1 Standard deviation																			
	One-third Octave Band Center Frequency (Hz)																			
3,	63	80	100	125	160	200	250	315	400	500	630	800	1k	1.25k	1.6k	2k	2.5k	3.15k	4k	5k
5 - 22	0.6	0.5	0.6	0.4	1.3	2.1	4.3	5.2	5.8	5.1	6.6	6.2	5.7	4.9	5.0	4.9	4.8	5.1	4.7	4.1

TABLE 4-13: STANDARD DEVIATION BETWEEN ALL PHASE 1 TEST SPECIMENS

The dB improvements ranged from 6 to 15 dB above the TL13-311 mullion constant (Table 4-14).

Phase	Mullion Specimen Description	dB Improvement
Ph1-A	Infill: none Overclad: none	(TL13-311, STC 36 is used to compare other phases)
Ph1-B	Infill: Varied Overclad: None	6 dB improvement at frequencies above 800 Hz
Ph1-C1	Infill: Pea Gravel or MLV Pillows Overclad: 1/8" Alum + 3/16" Mass Limp Vinyl	14 dB improvement at frequencies above 250 Hz
Ph1-C2	Infill: Pea Gravel or MLV Pillows Overclad: 5/8" Gypsum + 3/16" Mass Limp Vinyl	15 dB improvement at frequencies above 250 Hz
Ph1-C3	Infill: Pea Gravel or MLV Pillows Overclad: 5/8" Gypsum	11 dB improvement at frequencies above 250 Hz
Ph1-C4	Infill: Pea Gravel or MLV Pillows Overclad: Aluminum Tube with Resilient Connection	9 dB improvement at frequencies above 250 Hz

TABLE 4-14: PHASE 1 COMPARISONS WITH MC-1 (TL13-311)

Overall observations:

- The greatest improvement influence with filled mullions occurred at mid to high frequencies.
- Overclad generally outperformed filling the mullion cavity.
- Modifying a mullion with both an overclad and mullion cavity infill is significantly effective to improve a hollow and bare mullion.

4.3 PHASE 2A – COMPOSITE SEAL AND CONNECTION ELEMENTS (WITH MULLION)

This laboratory test phase measures the TL performance of the vertical mullion and a partition connection or partition seal, therefore specimens in this phase consist of a composite of both elements. The selected vertical mullions used in this phase are the MC-1 (TL13-311) mullion and the MC-2 (TL13-323) mullion. The glazing element is not included in this phase of testing. Specific configuration descriptions are provided in the following sections. A total of 25 laboratory measurements were conducted in this phase (Figure 4-25).

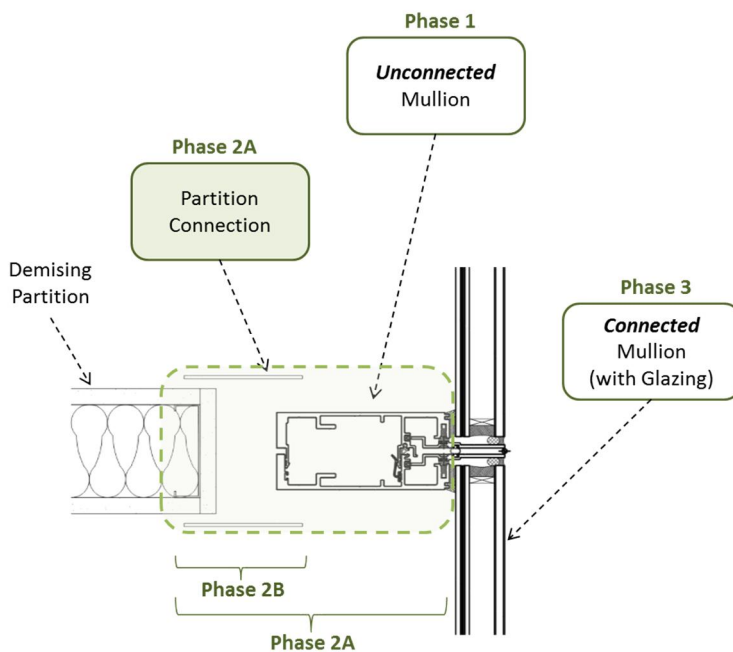

Date July 17 – 20, 2013

Laboratory: WEAL

Specimen: Connection Element with mullion, no glazing

Dimensions: Connection depth varies

Surface Area: varies, 2.81 ft² to 3.75 ft²

Transmission: Horizontal

Procedure: ASTM E90-09

Total Tests: 25

FIGURE 4-25: PHASE 2A: PLAN DIAGRAM OF UVM ELEMENTS AND ASSOCIATED TEST PHASES

Mullion partition connections and seals often vary in material and width and are dependent on the *in situ* condition. They are often used to seal the deflection gap required between partition and the curtain wall to accommodate wind, seismic or thermal loads. These connection products typically consists of a material capable of static deflections that accommodate these requirements, such as foam, rubber, silicone, etc.

Some of the tests in this phase do not necessarily target sound flanking performance but potential acoustic leaks instead, so that standard approaches seen in practice may be compared.

4.3.1 PHASE 2A TEST SPECIMEN DESCRIPTION

In this phase, the filler wall was modified for a two aperture sizes to accommodate various test specimens. The **narrow aperture dimension** is 3.26 ft² (7-3/4" x 60-1/2"), 0.3 m² (Figure 4-26). The dimension allows measurements with the vertical mullion and an edge seal condition of 1/2" to 3/4" gaps.

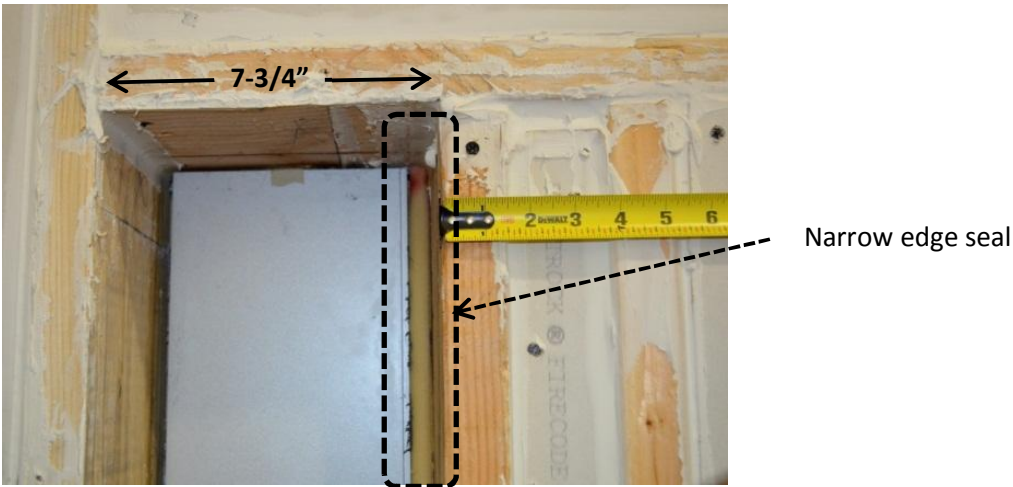

FIGURE 4-26: HEAD OF NARROW APERTURE WIDTH OF 7-3/4"
SHOWN WITH A MULLION AND 1/2" BACKER ROD (ALSO SHOWN IS 4" REMOVABLE SECTION OF THE FILLER WALL)

The **wide aperture dimension** is 3.89 ft² (9-1/4" width x 60-1/2" height), 0.36 m² (FIGURE 4-27).

This allowed mullions to be tested with a 2-1/2" deep connection element. However, the typical depth was 8-3/4" to provide 1/4" compression at the silicone element between the mullion and filler wall. The 1/4" compression is per the Silicone Compression Seal® product specification.

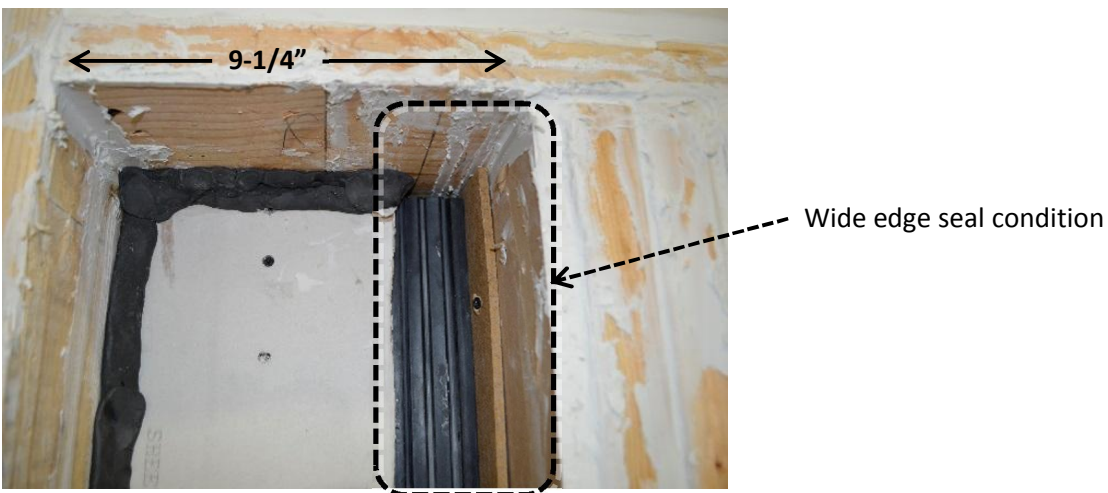

FIGURE 4-27: HEAD OF WIDE APERTURE WIDTH OF 8-1/4"
MULLION AND SILICONE CLOSURE SHOWN WITH PUTTY AT PERIMETER (4" SECTION IS REMOVED)

All mullions were inserted into the aperture first followed by the fitting of the vertical edge seal or partition connector element. Similar to phase 1, the vertical mullion had no direct contact with the filler wall. However the proposed resilient connection typically was compressed between the mullion and filler wall.

The resilient connection materials and dimensions tested for the Phase 2A series (TABLE 4-17 and TABLE 4-18) including the following:

- $\frac{1}{4}$ " – $\frac{3}{4}$ " backer rod and wet seal
- $\frac{1}{2}$ " Armacell® foam
- PCS-1 Silicone Compression Seal® product by Michael Rizza Company™: (2) 10' strips, width 2" min to 2-1/2" width
- PCS-1 Silicone Compression Seal® product and modified with an overlaid of aluminum or gypsum board plates

Also tested in Phase 2A was the Mull-it-Over™ (see TABLE 4-19) product, which is not defined in this research as a "connection element" but will be included in the evaluation for transmission loss performance of products.

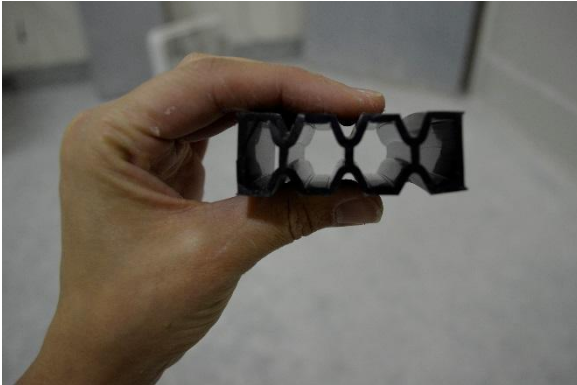

FIGURE 4-28: IMAGE OF THE PCS-1 SILICONE COMPRESSION SEAL® PROFILE; UNCOMPRESSED PROFILE DIMENSION 2-1/2" x 7/8"

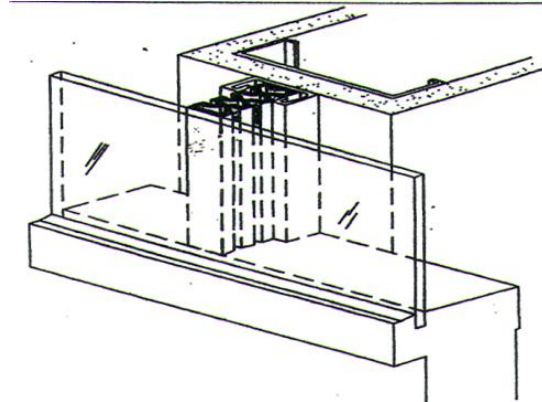

FIGURE 4-29: ISOMETRIC DRAWING OF THE PCS-1 SILICONE COMPRESSION SEAL® INSTALLATION (©2011 BALCO USA, INC.)

(Note: Image shows the compression seal terminating at glass, not the mullion.)

This product has been selected to simulate a resilient seal connection between a demising wall and mullion. It should be noted that there are other means and providing this type of resilient in practice.

4.3.2 PHASE 2A TESTING CLASSIFICATIONS

Tested configurations are categorized and tabulated (TABLE 4-15 TO TABLE 4-19).

TESTED SPECIMENS	Phase 2A Class A: 1/2" Vertical gap both sides of mullion
TL13-398, STC 42 TL13-399, STC 36 TL13-400, STC 42 TL13-401, STC 46 TL13-402, STC 49 TL13-404, STC 35	<p>A 1/2" vertical edge gap is at all vertical edges. Vertical gaps in Phase 1 were 1/4" and used acoustic putty for sealing.</p> <p>Class A configurations follow from Phase 1 (isolated mullion tests) to assess the influence of the open area of the test aperture. The horizontal width of the filler wall aperture was 7-1/4" during Phase 1. The width is 7-3/4" in this Phase 2A. This allows a 1/2" gap on either side of the mullion instead of 1/4" when the mullion specimen is centered in the aperture.</p>

TABLE 4-15: PHASE 2A CLASS A TEST CONFIGURATION DESCRIPTION, PLAN DRAWING

TESTED SPECIMENS	Phase 2A Class B: 1/2" - 3/4" Foam or Backer Rod Tests with Mullion
TL13-405, STC 44 TL13-406, STC 52 TL13-407, STC 34 TL13-408, STC 38 TL13-409, STC 49 TL13-410, STC 49 TL13-411, STC 49	<p>A 3/4" vertical edge gap with a resilient connection and wet seal is at one side of the mullion.</p> <p>A 1/4" vertical edge gap is at opposite side and sealed with acoustic putty.</p> <p>The width of these connections are the smallest tested in Phase 2A and are considered the minimum allowable façade deflection in practice. The 3/4" gap is filled with backer rod and caulking wet seal. The connection for Test TL13-405 consists of 1/2" compressed Armacell® in lieu of EMSEAL.</p>

TABLE 4-16: PHASE 2A CLASS B TEST CONFIGURATION DESCRIPTION, PLAN DRAWING

TESTED SPECIMENS	Phase 2A Class C: 2-1/4" Silicone Product Tests with Heavy Mullion
TL13-412, 31/29 TL13-413, 40One-third7 TL13-414, 32/30 TL13-415, 36/31 TL13-416, 34/32	<p>Mullion configuration from TL13-323 is connected to a 2-1/4" Rizza Silicone partition enclosure product. A 1/4" gap is at the opposite vertical edge.</p> <p>The intent of these tests is to assess the influence of the Michael Rizza Silicone Partition Closure® product on the best performing mullion specimen, MC-2 (TL13-323).</p> 

TABLE 4-17: PHASE 2A CLASS C TEST CONFIGURATION DESCRIPTION, PLAN DRAWING

TESTED SPECIMENS	Phase 2A Class D 2-1/4" Silicone Product Tests with Hollow/ Exposed mullion
TL13-417, STC 30 TL13-418, STC 35 TL13-419, STC 28 TL13-420, STC 31 TL13-421, STC 34 TL13-422, STC 22	<p>Mullion configuration from TL13-311 is connected to a 2-1/4" Rizza Silicone partition enclosure product. A 1/4" gap is at the opposite vertical edge.</p> <p>The intent of these tests is to assess the influence of the Michael Rizza Silicone Partition Closure on the MC1 (TL13-311) the hollow and exposed mullion.</p> 

TABLE 4-18: PHASE 2A CLASS D TEST CONFIGURATION DESCRIPTION, PLAN DRAWING

TESTED SPECIMENS	Phase 2A Class E Product Test (Mull-it-Over™)
TL13-423, STC 46	<p data-bbox="516 300 1451 365">A single test using the Mull-It-Over product and hollow mullion was measured. Chapter 2 contains further description of the Mull-it-Over™ product.</p>  <p data-bbox="1101 436 1356 464">2X8 AND 1X8 WOOD SHIM</p> <p data-bbox="1101 533 1356 560">COMPRESSIBLE GASKET</p> <p data-bbox="1101 588 1356 615">SOUND DEADENING COMPOSITE</p> <p data-bbox="1101 705 1356 732">ALUMINUM COVERPLATE</p>

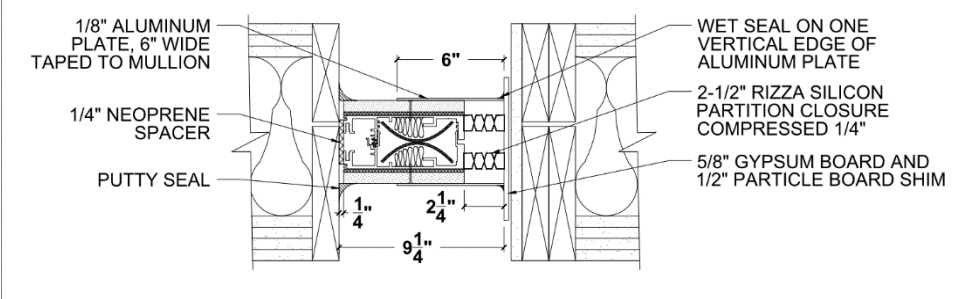
TABLE 4-19: PHASE 2A CLASS E TEST CONFIGURATION DESCRIPTION, PLAN DRAWING

Results in test configurations [A] through [D] tabulated below specifically call out the **vertical edge condition (VEC)** for each test assembly.

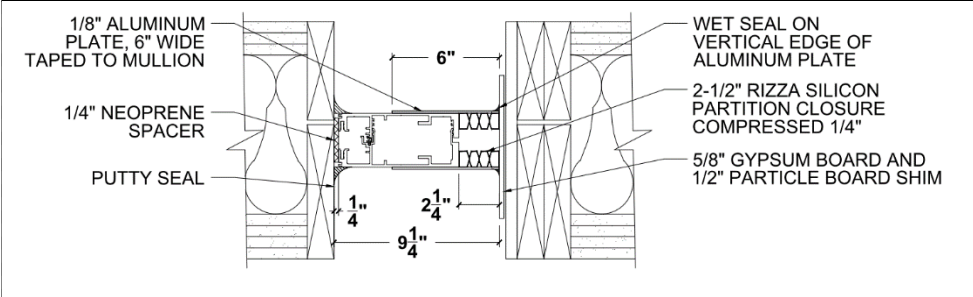
In all cases the PCS-1 Silicone Compression Seal® is compressed at least ¼" in all installations between the mullion and filler wall.

4.3.3 PHASE 2A CLASS A TEST SEQUENCE

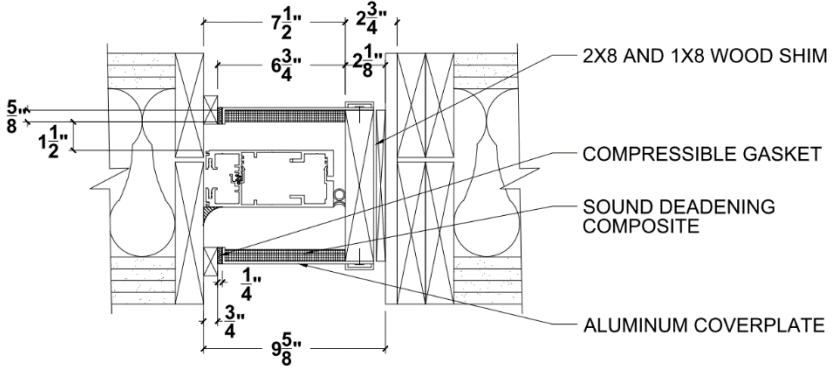
Results from the Class A testing sequence are summarized (Table 4-20).

WEAL Test No.	STC	Material Layers [description]	Element Drawing [Plan]
(25) TL13-398	42	<ol style="list-style-type: none"> [1] 1-1/2" (16 mm) MLV pillow+ alum tube [2] 1/4" (6mm) airspace MLV buttons [3] 1/8" (3mm) aluminum mullion [4] 2-3/4" (70mm) air space [5] 1/8" (3mm) aluminum mullion [6] 1/4" (6mm) airspace MLV buttons [7] 1-1/2" (16 mm) MLV pillow+ alum tube <p>[7/8" edge gap sealed with putty] [TL13-329, 48 / 42]</p>	<p>The drawing shows a cross-section of a window assembly. It features two glass panes held together by a central mullion. On either side of the mullion, there are MLV pillows and buttons. The assembly is sealed with putty at the edges. Dimensions of 7/8" are indicated for the edge gaps.</p>
(26) TL13-399	36	<ol style="list-style-type: none"> [1] 1/8" (3mm) aluminum mullion [2] 2-3/4" (70mm) air space [3] 1/8" (3mm) aluminum mullion <p>[1/2" edge gap sealed with putty] [TL13-311, 36 / 33]</p>	<p>The drawing shows a cross-section of a window assembly with two glass panes and a central air space. The panes are held together by a central mullion. The assembly is sealed with putty at the edges. Dimensions of 1/2" are indicated for the edge gaps.</p>
(27) TL13-402	49	<ol style="list-style-type: none"> [1] 5/8" (16 mm) gypsum board plate [2] 3/16" (5 mm) MLV layer [3] 1/8" (3mm) aluminum mullion [4] 2-3/4" (70mm) MLV pillows [5] 1/8" (3mm) aluminum mullion [6] 3/16" (5 mm) MLV layer [7] 5/8" (16 mm) gypsum board plate <p>[1/2" edge gap sealed with putty] [TL13-323, 52 / 43]</p>	<p>The drawing shows a cross-section of a window assembly with two glass panes and a central mullion. The assembly is surrounded by gypsum board plates and MLV layers. MLV pillows are placed around the mullion. The assembly is sealed with putty at the edges. Dimensions of 1/2" are indicated for the edge gaps.</p>
(28) TL13-404	35	<ol style="list-style-type: none"> [1] 1/8" (3mm) aluminum mullion [2] 2-3/4" (70mm) air space [3] 1/8" (3mm) aluminum mullion <p>[1/2" edge gap sealed with putty] [TL13-315, 36 / 34]</p>	<p>The drawing shows a cross-section of a window assembly with two glass panes and a central mullion. The assembly is filled with ram-packed mineral wool. The assembly is sealed with putty at the edges. Dimensions of 1/2" are indicated for the edge gaps.</p>

TABLE 4-20: PHASE 2A CLASS A, STC RESULTS AND SPECIMEN DESCRIPTION

4.3.3.1 PHASE 2A-A DEDUCTIONS AND OBSERVATIONS

The following Class A observations are compared with similar mullion composition in Phase 1:

- TL13-398 (STC 42) compared to Phase 1 TL13-329 (STC 48)
The test performance in Phase 2a is significantly lower than the previous Phase 1 and not as tonal however shares a similar coincidence dip and overall reduction.
- TL13-399 (STC 36) compared to Phase 1 TL13-311 (STC 36)
The test in this phase has a similar performance as the previous Phase 1 but has a reduced TL at low frequencies. This may be attributed to the increased perimeter gap, i.e. from ¼" to ½" on each side.
- TL13-402 (STC 49) is compared to Phase 1 TL13-323 (STC 52)
The test performance is less than the test in Phase 1. This may be due to the increased perimeter gap.
- TL13-404 (STC 35) is compared to TL13-315 (STC 36)
The test performance is almost identical. This indicates that ram-packing mineral wool versus laying in the fill material does not make a significant difference.

In general, all the retested mullions performed lower than the similar Phase 1 mullions. The air slot created between the mullion and the chamber filler wall may be adversely influencing the lower TL performance. The gap dimension is typically ½" wide x 60-1/2" tall x 3" deep.

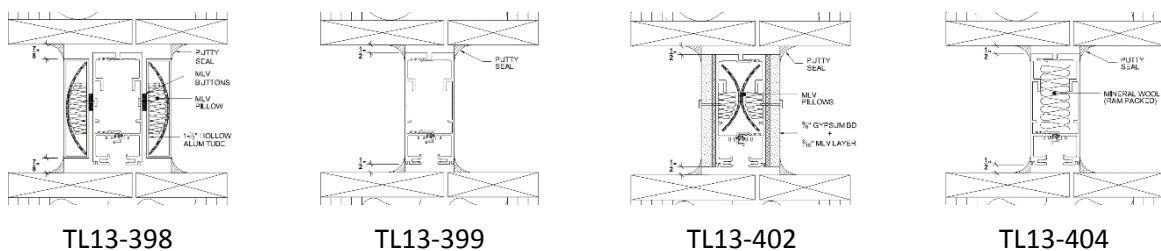
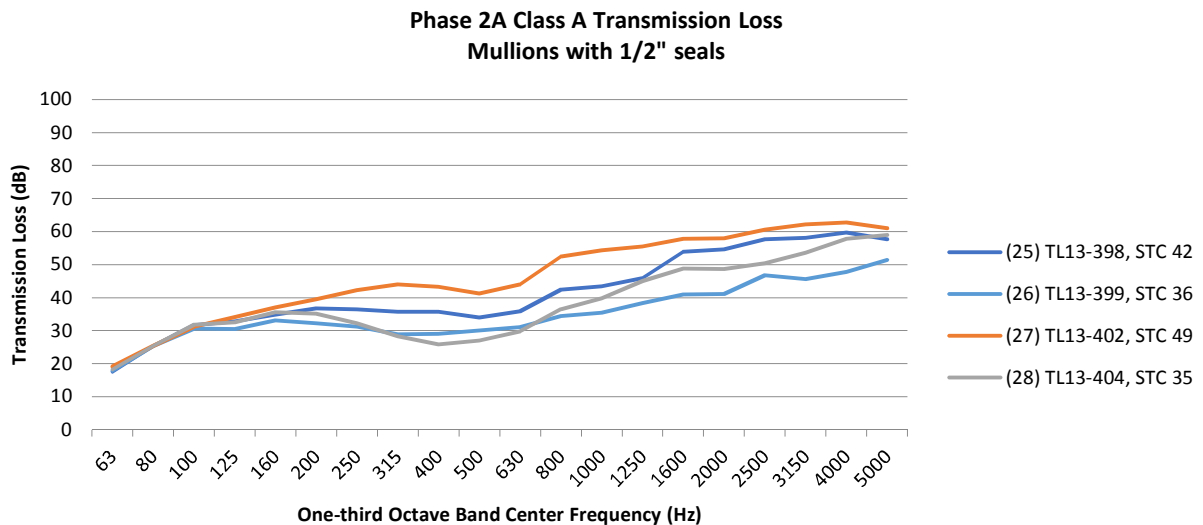

FIGURE 4-30: PHASE 2A-A, TL OF MULLIONS WITH ½" VERTICAL SEAL

4.3.4 PHASE 2A CLASS B TEST SEQUENCE

Results from the Class B testing sequence are summarized (Table 4-21).

WEAL Test No.	STC	Material Layers [description]	Element Drawing [Plan]
(29) TL13-405	44	<p>[1] 5/8" (16 mm) gypsum board plate [2] 3/16" (5 mm) MLV layer [3] 1/8" (3mm) aluminum mullion [4] 2-3/4" (70mm) MLV pillows [5] 1/8" (3mm) aluminum mullion [6] 3/16" (5 mm) MLV layer [7] 5/8" (16 mm) gypsum board plate</p> <p>VEC: 1/2" Armacell® [3 edges 1/4" putty, 1/4" wood shim for compression on 1/2" Armacell®] [TL13-323, 52 / 43]</p>	
(30) TL13-406	52	<p>[1] 5/8" (16 mm) gypsum board plate [2] 3/16" (5 mm) MLV layer [3] 1/8" (3mm) aluminum mullion [4] 2-3/4" (70mm) MLV pillows [5] 1/8" (3mm) aluminum mullion [6] 3/16" (5 mm) MLV layer [7] 5/8" (16 mm) gypsum board plate</p> <p>VEC: 3/4" foam backer rod +wet seal [3 edges 1/4" putty, 1/4" neoprene shim] [TL13-323, 52 / 43]</p>	
(31) TL13-407	34	<p>[1] 1/8" (3mm) aluminum mullion [2] 2-3/4" (70mm) air space [3] 1/8" (3mm) aluminum mullion</p> <p>VEC: 3/4" foam backer rod +wet seal [3 edges 1/4" wet seal, 1/4" neoprene shim] [TL13-311, 36 / 33; TL13-399, 36 / 33]</p>	
(32) TL13-408	38	<p>[1] 1/8" (3mm) aluminum mullion [2] 2-3/4" (70mm) air space [3] 1/8" (3mm) aluminum mullion</p> <p>VEC: 3/4" foam backer rod +wet seal [3 edges wet seal + masking tape + putty, neoprene shim] [TL13-311, 36 / 33; TL13-399, 36 / 33; TL13-407, 34/32]</p>	

WEAL Test No.	STC	Material Layers [description]	Element Drawing [Plan]
(33) TL13-411	49	[1] 1-1/2" (16 mm) MLV pillow+ alum tube [2] 1/4" (6mm) airspace MLV buttons [3] 1/8" (3mm) aluminum mullion [4] 2-3/4" (70mm) air space [5] 1/8" (3mm) aluminum mullion [6] 1/4" (6mm) airspace MLV buttons [7] 1-1/2" (16 mm) MLV pillow+ alum tube VEC: 3/4" foam backer rod +wet seal [3 edges 1/4" wet seal, 1/4" neoprene shim] [TL13-329/30, 48 / 42; TL13-398, 42 / 37]	

TABLE 4-21: PHASE 2A CLASS B, STC RESULTS AND SPECIMEN DESCRIPTION

4.3.4.1 PHASE 2A-B DEDUCTIONS AND OBSERVATIONS

The following Class B observations are compared with similar mullion composition in Phase 1:

- TL13-406 has the same rating as the same mullion tested in Phase 1, TL13-323, despite the wider edge condition. This may imply opportunities for design and/or savings.
- Putty did not perform as well at wet seal for the hollow aluminum tube overlaid tests
- TL13-405 (STC 44) compared to Phase 1 TL13-323 (STC 52) and Phase 2A TL13-402 (STC 49):
The test performance of TL13-405 is significantly lower than the previous 323 and 402. The Armacell® foam material is porous and may indicate the acoustic leak occurring above 500 Hz.
- TL13-406 (STC 52) compared to Phase 1 TL13-323 (STC 52) and Phase 2A TL13-402 (STC 49):
The test performances between conditions are similar – the seal condition of TL13-406 includes a 3/4" gap at one edge with wet seal + backer rod, whereas the seal condition for TL13-323 and TL14-402 were applied with a dense putty on a narrower edge gap.
This may indicate that a "connection" gap of 3/4" for lateral facades deflection may not adversely influence the overall Transmission Loss performance.
- TL13-407 (STC 34) compared to TL13-399 (STC 36) and Phase 1 TL13-311 (STC 36):
Generally, the performance is similar. The greater gap of 3/4" in test 407 dips at 400Hz.
- TL13-408 (STC 38) compared to -399, -311, -407
This test is identical to TL13– 407 with the exception of adding masking tape and putty to 3 sides of the mullion to isolate the 3/4" wet seal edge. There is a noted improvement where the entire curve shifts up 4dB. The improvement may be attributed to the improved edge seal condition further reducing sound leaks and the increased damping from the putty impeding additional vibration.
- TL13-411 (STC 49) is compared to TL13-330 (STC 48), TL 13-398 (STC 42)
The mullion in Phase 1 test -330 was filled with MLV pillows and had a 1/4" air space on either side. The configuration in test -411 used had a 1-1/4" wet seal edge on one side and 1/2" edge seal on the other.

- Test TL13-398 performed significantly poorer than TL13-411. The main difference between the two setups was the edge seal condition. Putty covered the 7/8" edge gap in test TL13-398 and a wet seal caulk was used in test TL13-411. This seems to imply there is no significant difference between using wet seal versus putty and that the wider edge condition (i.e. 1-1/4" versus 3/4") does not adversely impact the overall performance as long as the seal is airtight. Further there are diminishing returns with adding mass to the mullion in the form of fill and overclad material. In this test, there was no significant difference between a filled mullion and non-filled mullion. The hollow tube overclad filled with a damping layer was identical for both tests.
- No significant difference between putty and wet seal.
- The air slot created on either side of the mullions and the chamber filler wall varies: one side is generally 1/4" wide x 60-1/2" tall x 3" deep and the other side is general 3/4" wide and filled with to strips of backer rod and wet sealed. These gaps are not adversely influencing the performance of the mullion and are performing similar to the Phase 1 tests.
- Transmission loss plots TL13-408 -399, -311, -407 should be compared in more detail for trends based on the different sealed conditions. This analysis is not included as part of the research study.
- Possible resonant frequency for mullion is at 400Hz. Mullion resonant frequency should be tested.

Phase 2 Class B Transmission Loss
1/2" foam and 3/4" backer rod + caulking

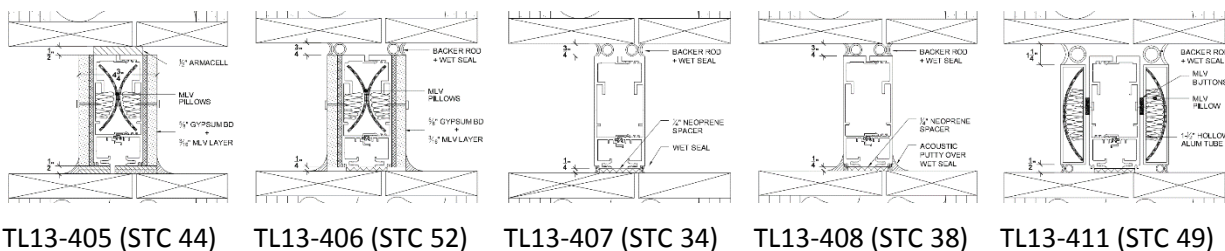
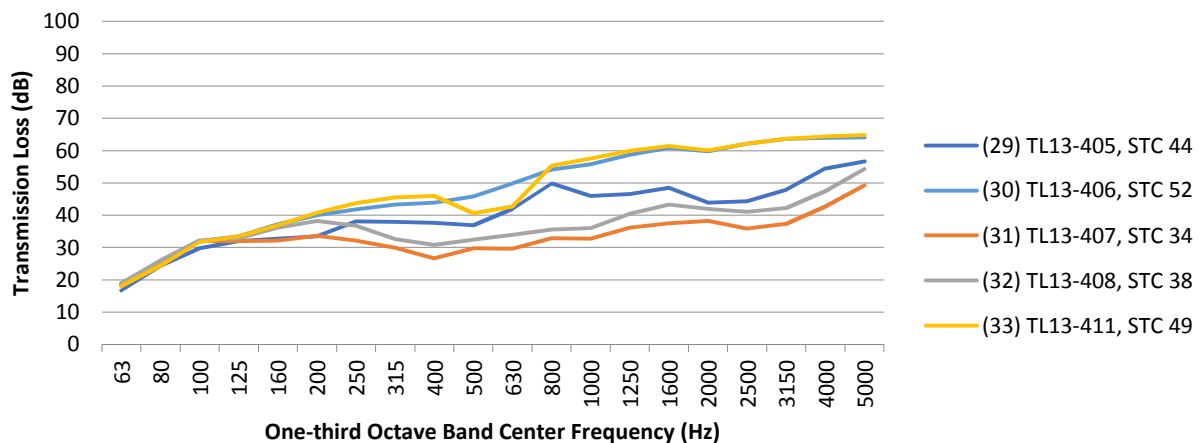
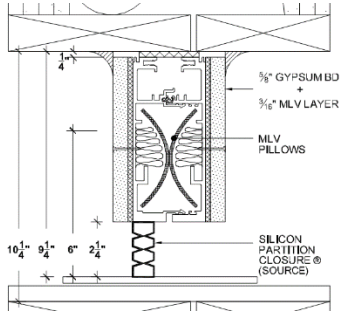
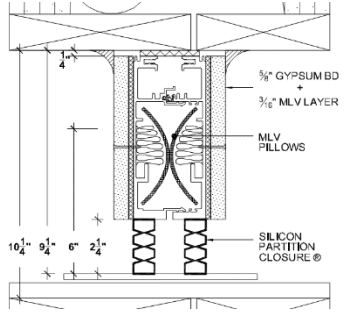
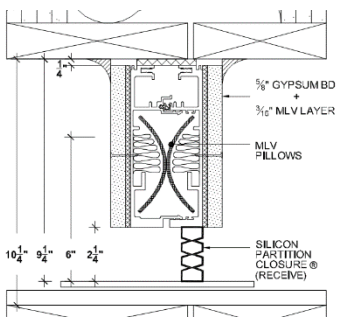

FIGURE 4-31: PHASE 2A-B, TL OF MULLIONS WITH 1/2" AND 3/4" SEALS

4.3.5 PHASE 2A CLASS C TEST SEQUENCE

Results from the Class C testing sequence are summarized (Table 4-22):

WEAL Test No.	STC	Material Layers [description]	Element Drawing [Plan]
(34) TL13-412	31	<p>[1] 5/8" (16 mm) gypsum board plate [2] 3/16" (5 mm) MLV layer [3] 1/8" (3mm) aluminum mullion [4] 2-3/4" (70mm) MLV pillows [5] 1/8" (3mm) aluminum mullion [6] 3/16" (5 mm) MLV layer [7] 5/8" (16 mm) gypsum board plate</p> <p>VEC: (1) 2-1/2" Silicone Partition Closure® at source side [wet seal top and bottom of silicone, 3 edges 1/4" putty, 1/4" neoprene shim]</p>	
(35) TL13-413	41	<p>[1] 5/8" (16 mm) gypsum board plate [2] 3/16" (5 mm) MLV layer [3] 1/8" (3mm) aluminum mullion [4] 2-3/4" (70mm) MLV pillows [5] 1/8" (3mm) aluminum mullion [6] 3/16" (5 mm) MLV layer [7] 5/8" (16 mm) gypsum board plate</p> <p>VEC: (2) 2-1/2" Silicone Partition Closure® at both source and receiver sides [wet seal top and bottom of silicone, 3 edges 1/4" putty, 1/4" neoprene shim]</p>	
(36) TL13-414	32	<p>[1] 5/8" (16 mm) gypsum board plate [2] 3/16" (5 mm) MLV layer [3] 1/8" (3mm) aluminum mullion [4] 2-3/4" (70mm) MLV pillows [5] 1/8" (3mm) aluminum mullion [6] 3/16" (5 mm) MLV layer [7] 5/8" (16 mm) gypsum board plate</p> <p>VEC: (1) 2-1/2" Silicone Partition Closure® at receiver side [wet seal top and bottom of silicone, 3 edges 1/4" putty, 1/4" neoprene shim]</p>	

WEAL Test No.	STC	Material Layers [description]	Element Drawing [Plan]
(37) TL13-415	36	<p>[1] 5/8" (16 mm) gypsum board plate [2] 3/16" (5 mm) MLV layer [3] 1/8" (3mm) aluminum mullion [4] 2-3/4" (70mm) MLV pillows [5] 1/8" (3mm) aluminum mullion [6] 3/16" (5 mm) MLV layer [7] 5/8" (16 mm) gypsum board plate</p> <p>VEC: (1) 2-1/2" Silicone Partition Closure® at source side + 1/8" aluminum overlaid [wet seal top and bottom of silicone, 3 edges 1/4" putty, 1/4" neoprene shim, aluminum plate is wet sealed at vertical filler wall edge and adhered to mullion with masking tape]</p>	
(38) TL13-416	34	<p>[1] 5/8" (16 mm) gypsum board plate [2] 3/16" (5 mm) MLV layer [3] 1/8" (3mm) aluminum mullion [4] 2-3/4" (70mm) MLV pillows [5] 1/8" (3mm) aluminum mullion [6] 3/16" (5 mm) MLV layer [7] 5/8" (16 mm) gypsum board plate</p> <p>VEC: (2) 2-1/2" Silicone Partition Closure® at both sides + 1/8" aluminum overlaid [wet seal top and bottom of silicone, 3 edges 1/4" putty, 1/4" neoprene shim, aluminum plate is wet sealed at vertical filler wall edge and adhered to mullion with masking tape]</p>	

TABLE 4-22: PHASE 2A CLASS C, STC RESULTS AND SPECIMEN DESCRIPTION

*VEC (vertical edge condition)

4.3.5.1 PHASE 2A-C OBSERVATIONS

The following are based on the results from Phase 2A Class C test specimens:

- TL13-412 (STC 31) – one silicone connection, obvious tone 2 kHz, leaks at the top of the silicone connection.
- TL13-413 (STC 41) – two silicone connections; tone is not audible.
- TL13-414 (STC 32) – subjectively heard the same tone at 2 kHz, similar to TL13 -412. No difference in silicone placement at source or receiver side.
- TL13-415 (STC 36) – one silicone connection covered by a 1/8" metal plate; significant improvement at the mid to high frequencies (no 2 kHz tone), but reduced performance below 315 Hz.
- TL13-416 (STC 34) - same configuration as TL13-415 but with 2 silicone connections; improvement over entire spectrum at low and high frequencies with the exception of 400Hz. STC is irrelevant here since discriminating at 400Hz.

The transmission loss of MC-2 is plotted against versions of the composite MC-2 with a silicone connection (FIGURE 4-32).

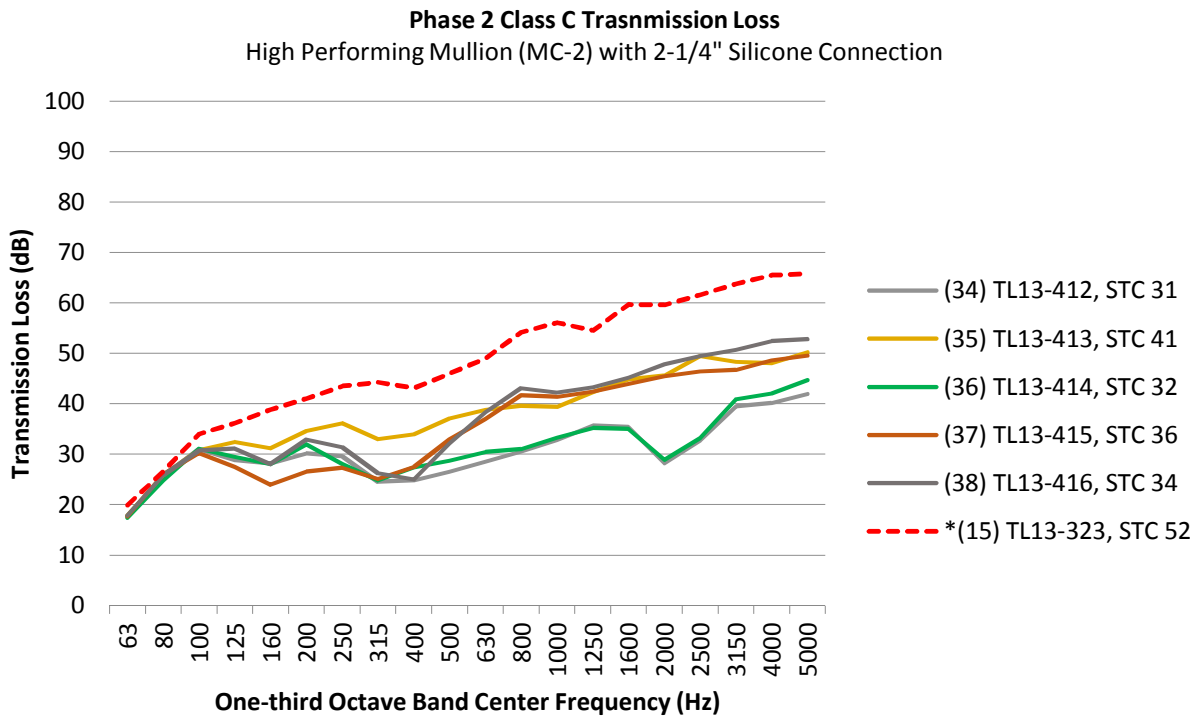

FIGURE 4-32: PHASE 2A-C, TL OF HIGHER PERFORMING MULLION WITH SILICONE PARTITION CLOSURE®

*TREATED MULLION BASE CASE, MC2

The following two specimens are set up identically in the filler wall with the exception of 1/8" aluminum plates enclosing the silicone partition connection at TL13-416 (FIGURE 4-33):

- TL13-413 STC 41 (No overlaid)
- TL13-416 STC 34 (Added 1/8" aluminum overlaid)

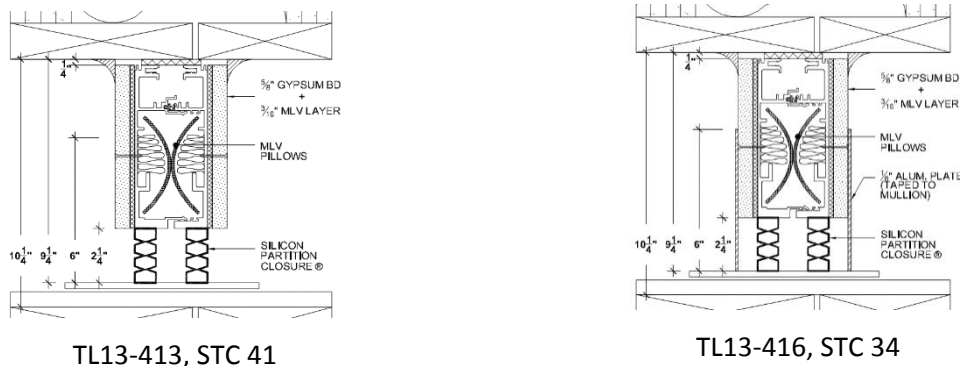

FIGURE 4-33: PLAN DRAWING OF TL13-413 (LEFT) AND TL 416 (RIGHT)

The TL13-416 configuration performs 7dB lower than the TL13-413 specimen without the aluminum enclosure. This is due to a resonance created by the aluminum plate at 400 Hz (FIGURE 4-34).

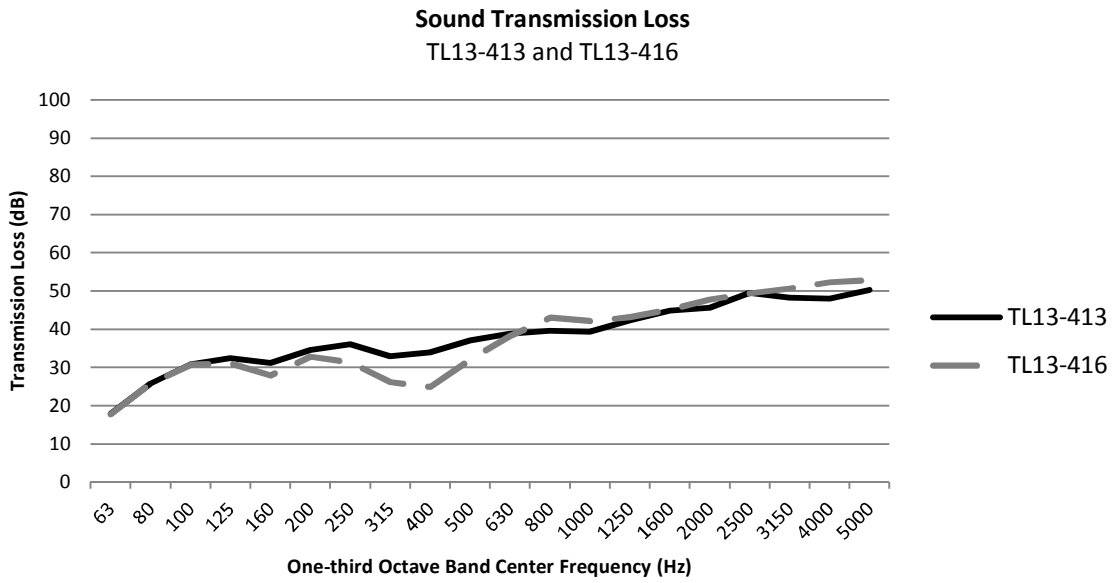

FIGURE 4-34: SOUND TRANSMISSION LOSS CURVES OF TL13-413 AND TL13-416

4.3.6 PHASE 2A CLASS D TEST SEQUENCE

Results from the Class C testing sequence are summarized (Table 4-31).

WEAL Test No.	STC	Material Layers [description]	Element Drawing [Plan]
(39) TL13-417	30	<p>[1] 1/8" (3mm) aluminum mullion [2] 2-3/4" (70mm) air space [3] 1/8" (3mm) aluminum mullion</p> <p>VEC: (1) 2-1/2" Silicone Partition Closure[®] at source side [wet seal top and bottom of silicone, 3 edges 1/4" putty, 1/4" neoprene shim]</p>	
(40) TL13-418	35	<p>[1] 1/8" (3mm) aluminum mullion [2] 2-3/4" (70mm) air space [3] 1/8" (3mm) aluminum mullion</p> <p>VEC: (2) 2-1/2" Silicone Partition Closure[®] at both source and receiver sides [wet seal top and bottom of silicone, 3 edges 1/4" putty, 1/4" neoprene shim]</p>	
(41) TL13-419	28	Data not used, incorrect surface area	TL13-420
(42) TL13-420	31	<p>[1] 1/8" (3mm) aluminum mullion [2] 2-3/4" (70mm) air space [3] 1/8" (3mm) aluminum mullion</p> <p>VEC: (2) 2-1/2" Silicone Partition Closure[®] at both sides + 1/8" aluminum overlaid [wet seal top and bottom of silicone, 3 edges 1/4" putty, 1/4" neoprene shim; wet seal at vertical edge of aluminum plate and filler wall; adhered plate to mullion with masking tape]</p>	
(43) TL13-421	34	<p>[1] 1/8" (3mm) aluminum mullion [2] 2-3/4" (70mm) air space [3] 1/8" (3mm) aluminum mullion</p> <p>VEC: (1) 2-1/2" Silicone Partition Closure[®] at source side + 1/8" aluminum overlaid [wet seal top and bottom of silicone, 3 edges 1/4" putty, 1/4" neoprene shim; wet seal at vertical edge of aluminum plate and filler wall; adhered plate to mullion with masking tape]</p>	

WEAL Test No.	STC	Material Layers [description]	Element Drawing [Plan]
(44) TL13-422	22	[1] 1/8" (3mm) aluminum mullion [2] 2-3/4" (70mm) air space [3] 1/8" (3mm) aluminum mullion VEC: 1/8" aluminum plate overlaid [3 edges 1/4" putty, 1/4" neoprene shim; wet seal at vertical edge of aluminum plate and filler wall; adhered plate to mullion with masking tape]	

TABLE 4-23: PHASE 2A CLASS D, STC RESULTS AND SPECIMEN DESCRIPTION

4.3.6.1 PHASE 2A-D OBSERVATIONS

The following are based on the results from Phase 2A Class D test specimens:

- TL13-417 (STC 30) – performs lower than TL13-311 and performs similarly to TL13-412
- 10dB improvement between TL13-412 and TL13-413
- 5dB improvement between TL13-417 and TL13-418

The TL of MC-1 is plotted against versions of the composite MC-1 with a silicone connection (FIGURE 4-35).

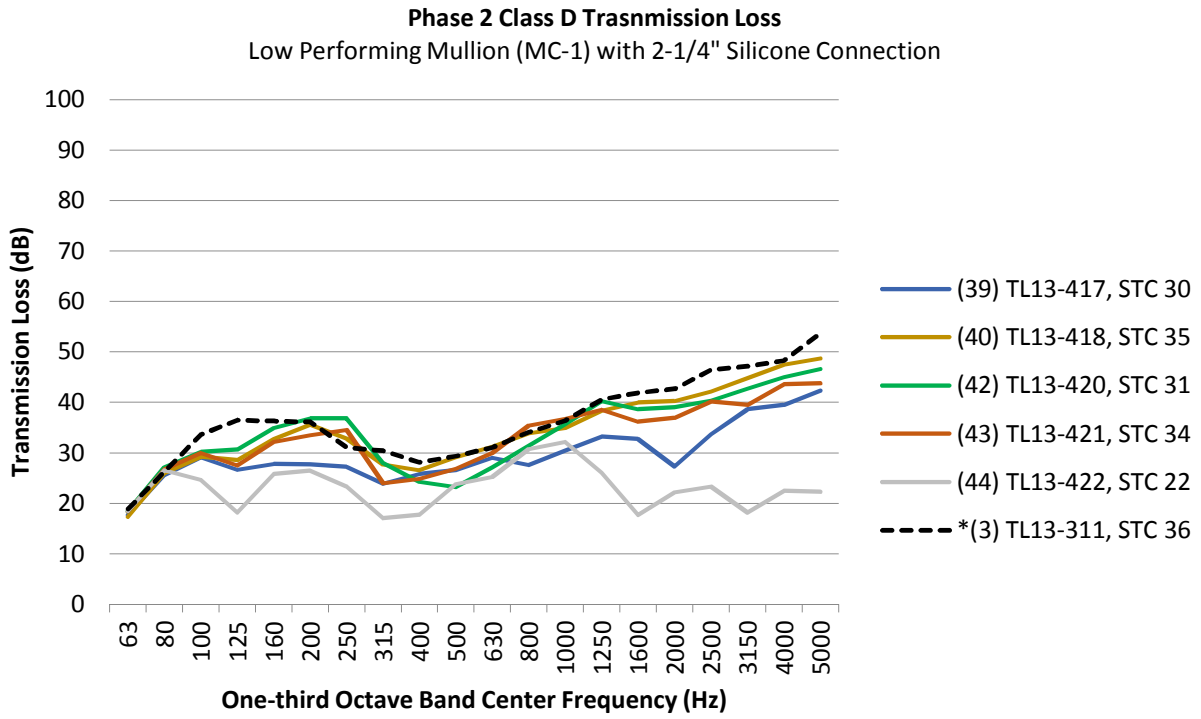

FIGURE 4-35: TL OF HOLLOW/EXPOSED MULLION CONNECTED TO RIZZA SILICONE PARTITION CLOSURE®

*UNTREATED MULLION BASE CASE, MC1

The following two specimens are set up identically in the filler wall with the exception of 1/8" aluminum plates enclosing the silicone partition connection at TL13-420 (FIGURE 4-36):

- TL13-418 STC 35 (No overclad)
- TL13-420 STC 31 (Added 1/8" aluminum overclad)

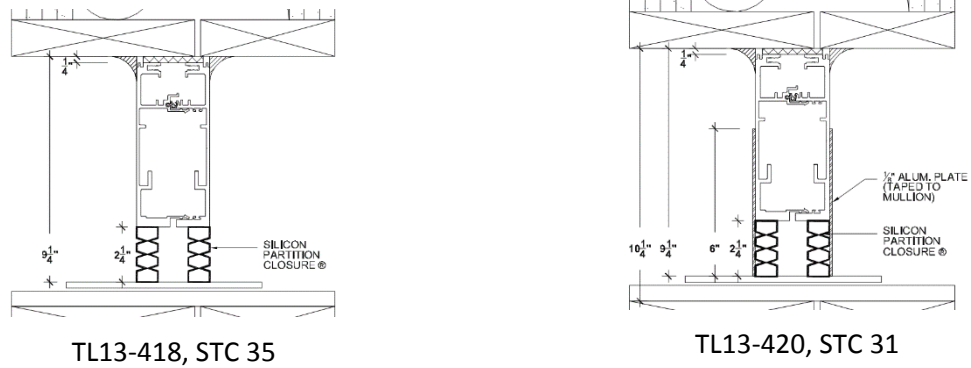

FIGURE 4-36: PLAN DRAWING OF TL13-418 (LEFT) AND TL 420 (RIGHT)

The TL13-420 configuration performs 4dB lower than the TL13-418 specimen without the aluminum enclosure. This is due to a resonance at 500 Hz attributed to the aluminum plates (FIGURE 4-37). This is not an outstanding difference; however it indicates that a wider partition connection has less of an influence on a low performing mullion.

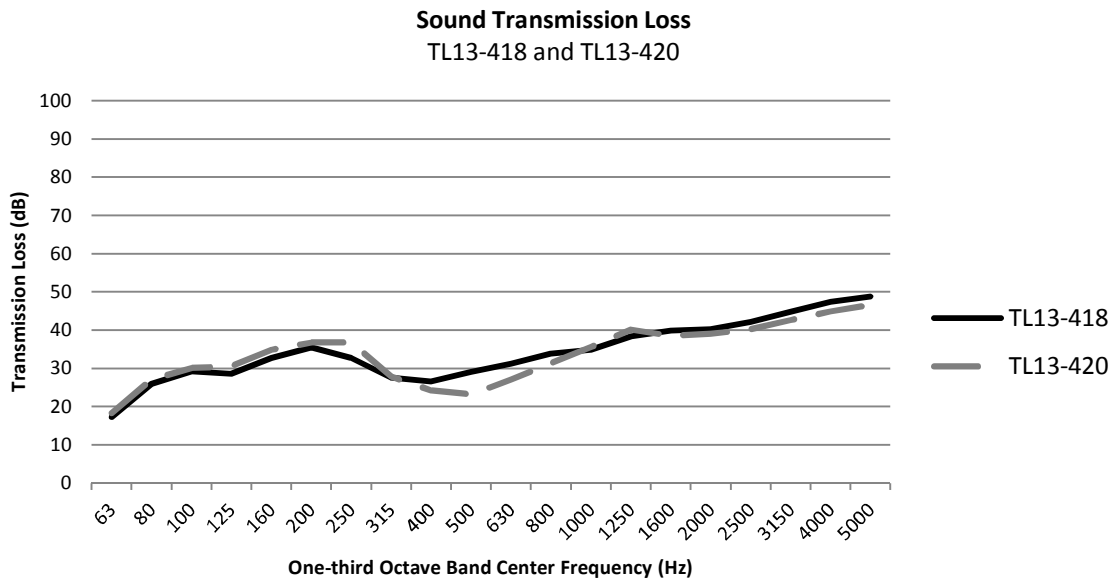

FIGURE 4-37: SOUND TRANSMISSION LOSS CURVES OF TL13-418 AND TL13-420

4.3.7 PHASE 2A CLASS E TEST SEQUENCE

The Class E sequence was limited to one test shown (TABLE 4-24).

WEAL Test No.	STC	Material Layers [description]	Element Drawing [Plan]
(45) TL13-423	46	<p>[1] Mull-It-Over[®] (alum+vinyl+foam) [2] 2-1/4" (57mm) air space [3] 1/8" (3mm) aluminum mullion [4] 2-3/4" (70mm) air space [5] 1/8" (3mm) aluminum mullion [6] 1-1/2" (38mm) air space [7] Mull-It-Over[®] (alum+vinyl+foam)</p> <p>[overall width 8-1/4" (210mm)] [mullion: putty on 3 sides, 1/2" backer rod +wet seal on one side; mull-it-over[®]: putty on top and bottom, wet seal on screws, compression seal at the 3/4" vertical continuous wood spacer]</p>	

TABLE 4-24: PHASE 2A CLASS E, STC RESULTS, AND SPECIMEN DESCRIPTION

4.3.8 PHASE 2A CONCLUSION

The mullions tested in Phase 2A contained vertical edge conditions (VEC) including either a narrow seal or wide connection (FIGURE 4-38).

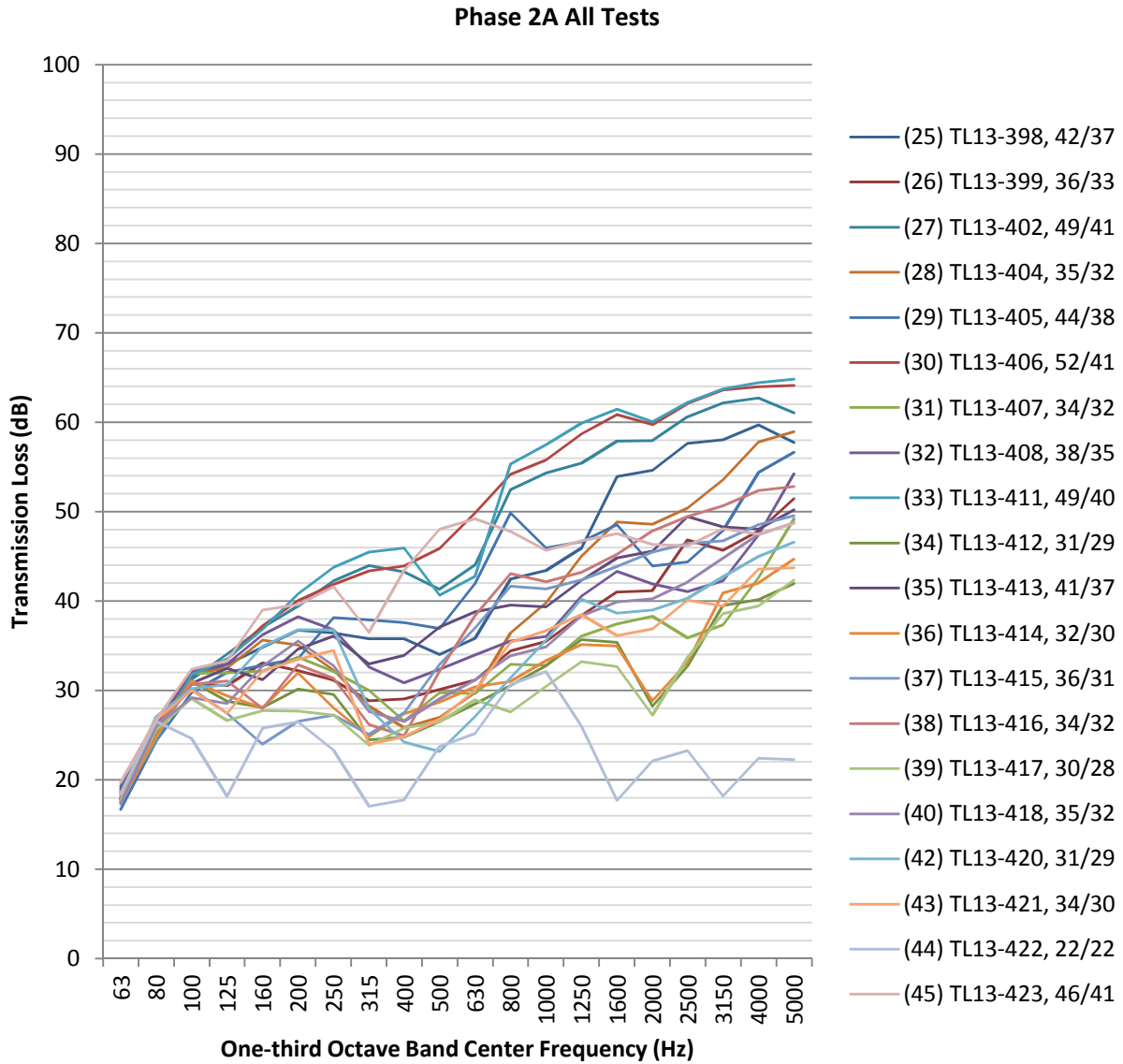

FIGURE 4-38: TL SPECTRA OF ALL PHASE 2A TESTS

There are no obvious trends in this test series as the specimen modifications varied significantly.

The lowest performing test in Phase 2A is TL13-422 (STC 22). The highest performing is TL13-406 (STC 52), which is nearly identical to TL13-323 (MC-2) in Phase 1. The lowest performing with a silicone closure connection is TL13-417 (STC 30). The highest performing with a silicone closure connection is TL 413 (STC 41).

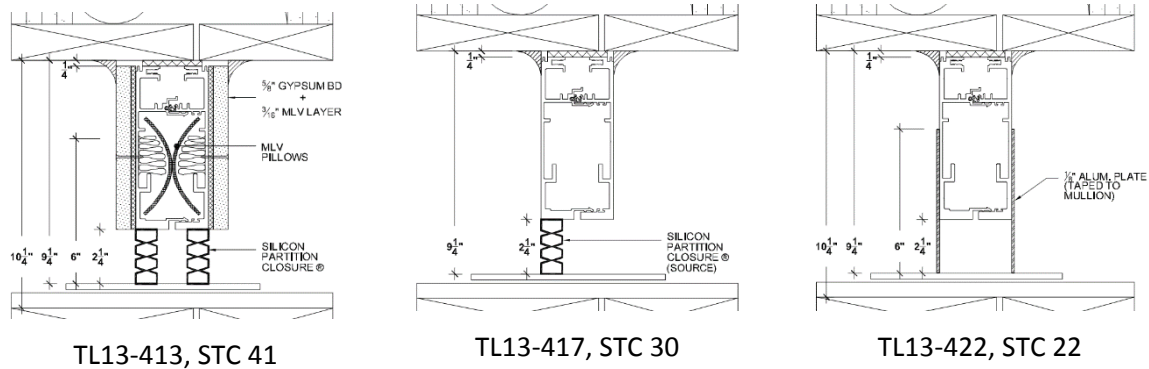

FIGURE 4-39: PLAN DRAWING OF TL13-413 (LEFT), TL13-417 (MIDDLE) AND TL 422 (RIGHT)

Table 4-25 summarizes the single figure STC range of the mullions with narrow or vertical edge condition (VEC).

	NARROW VEC (SEAL)	WIDE VEC (CONNECTION)
PHASE 2A	Range of STC results	Range of STC results
Mullion Constant 1 (TL13-311 STC36)	34 - 38	22 - 35
Mullion Constant 2 (TL13-323 STC 52)	49 - 52	31 - 41

TABLE 4-25: RESULT SUMMARY OF STC RANGE FOR SMALL AND LARGE VEC

*The Armacell® foam connection test with a heavy mullion is STC 44 and was not included in the summary table above since it was only measured with MC-2 and not MC-1.

As would be expected, a narrow connection does not significantly reduce the performance of the respective mullion constants (e.g. TL13-311 and TL13-323) tested in Phase 1. Whereas a wider connection significantly impacts the mullion performance as seen with specimen TL13-413, STC 41. This is an 11dB STC reduction from the mullion constant TL13-323, STC 52 tested in Phase 1.

This confirms the importance of potential acoustic leaks that can occur in practice and provides a standard for comparison against the mullions in Phase 1.

4.3.8.1 TL SUMMARY GRAPHS

The following transmission loss tables (FIGURE 4-40 AND Figure 4-44) are shown below for archival purposes. They include the transmission loss test results in this phase with overlays of the mullion constants as means for comparison.

MC-1 with a Narrow Vertical Edge Seal

The measurement condition in this configuration considers a representative deflection less than $\frac{3}{4}$ " in one axis with Mullion Constant 1 (non-modified unitized mullion). Standard deviation of the transmission loss curves shown indicate that a small edge condition ($< \frac{3}{4}$ ") has a greater influence on a lighter mullion (FIGURE 4-40).

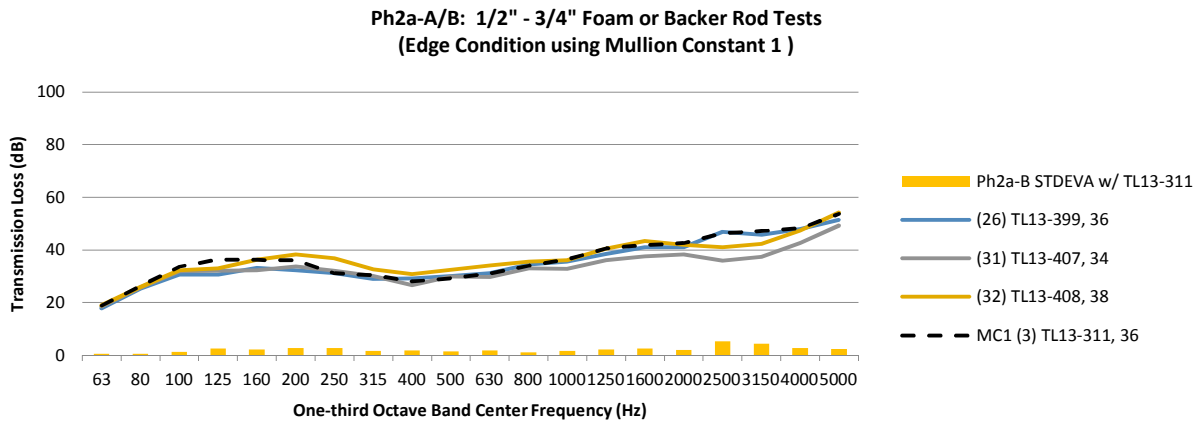

FIGURE 4-40: PHASE 2A MC-1 COMPARED TO A COMPOSITE OF MC-1 + SMALL DEFLECTION CONNECTION

*UNTREATED MULLION BASE CASE, MC1

MC-2 with a Narrow Vertical Edge Seal

The measurement condition in this configuration considers a representative deflection less than $\frac{3}{4}$ " in one axis with Mullion Constant 2 (modified unitized mullion, high performing). Standard deviation of the transmission loss curves shown indicate that a small edge condition ($< \frac{3}{4}$ ") has less influence on a heavier mullion (FIGURE 4-41).

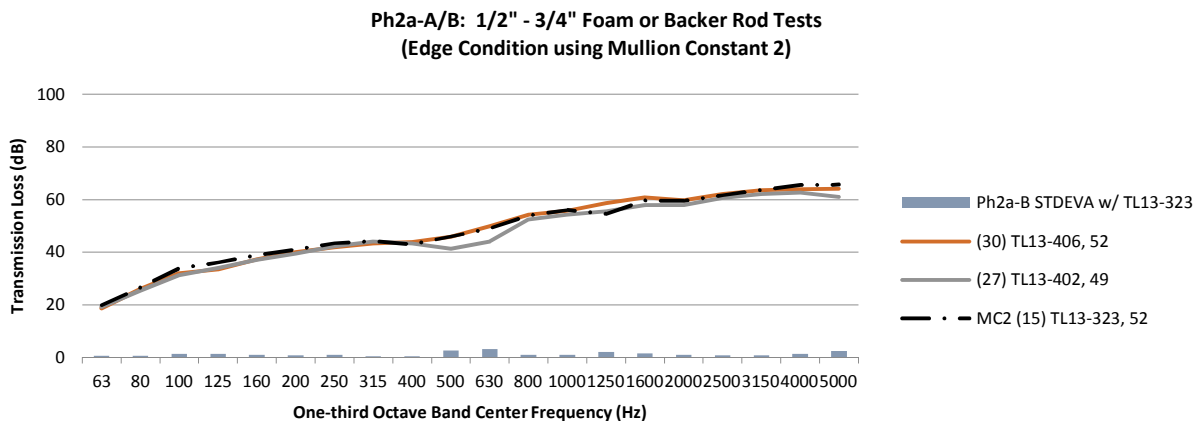

FIGURE 4-41: PHASE 2A MC-2 COMPARED TO A COMPOSITE OF MC-2 + SMALL DEFLECTION CONNECTION

MC-1 with a Wide Vertical Edge Seal

The measurement condition in this configuration considers a representative deflection greater than $\frac{3}{4}$ " in one axis with Mullion Constant 1. Standard deviation of the transmission loss curves indicate that a large edge condition (1" - 2") has a smaller influence on a lighter mullion (FIGURE 4-42).

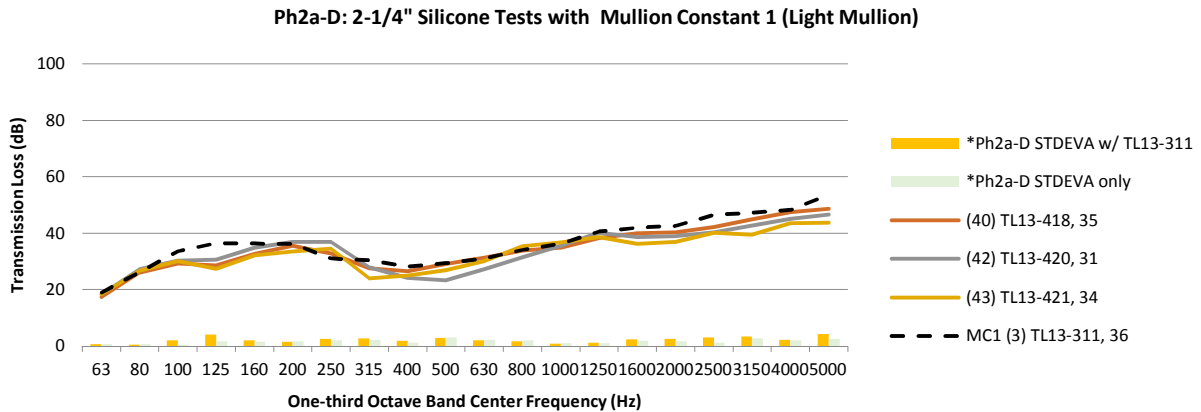

FIGURE 4-42: PHASE 2A MC-1 COMPARED TO A COMPOSITE OF MC-1 + LARGE DEFLECTION CONNECTION
*UNTREATED MULLION BASE CASE, MC1

MC-2 with a Wide Vertical Edge Seal

The measurement condition in this configuration considers a representative deflection greater than $\frac{3}{4}$ " in one axis with Mullion Constant 2 (modified unitized mullion, high performing). Standard deviation of the transmission loss curves shown indicate that a large edge condition (1" - 2") has a greater influence on a heavier mullion (FIGURE 4-43).

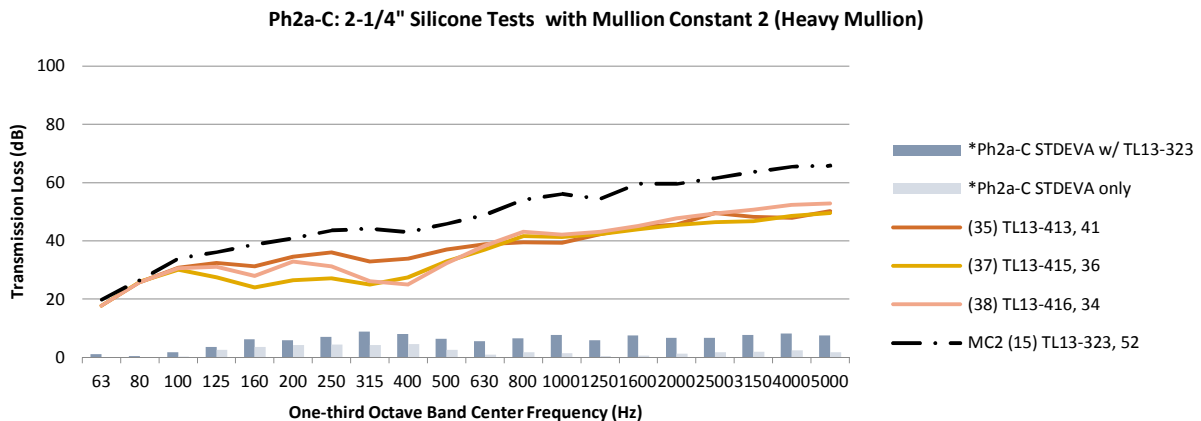
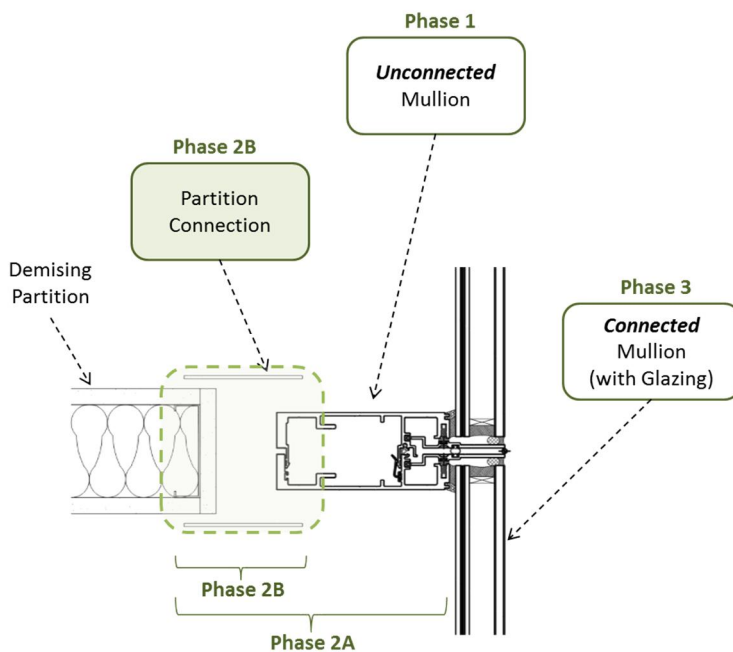

FIGURE 4-43: PHASE 2A MC-2 COMPARED TO A COMPOSITE OF MC-2 + LARGE DEFLECTION CONNECTION

4.4 PHASE 2B –CONNECTION ELEMENT (WITHOUT MULLION)

The following laboratory test phase measures the TL performance of acoustic concept connections used between a demising partition and a mullion. All partition connections are measured in the absence of the unitized vertical mullion and glazing elements. The intent of these measurements is to assess the influence of varying mass, airspace cavity and acoustic seal conditions. The TL results will be applied to composite TL predictions to support objective 4. Detail configuration descriptions are provided in the following sections. A total of 29 laboratory measurements were conducted in this phase (Figure 4-44).



Date October 8 – 11, 2013

Laboratory: WEAL

Specimen: Connection Element (no mullion)

Dimensions: Connection depth varies

Surface Area: 2.73 ft² (0.25m²), varies for product tests.

Transmission: Horizontal

Procedure: ASTM E90-09

Total Tests: 29

FIGURE 4-44: PHASE 2B: PLAN DIAGRAM OF UVM ELEMENTS AND ASSOCIATED TEST PHASES

The acoustic concepts connections designed for this test sequence consider either a parallel plate or staggered plate configuration (Figure 4-45). These diagram concepts were developed subsequent to discussions with curtain wall designers and architects.

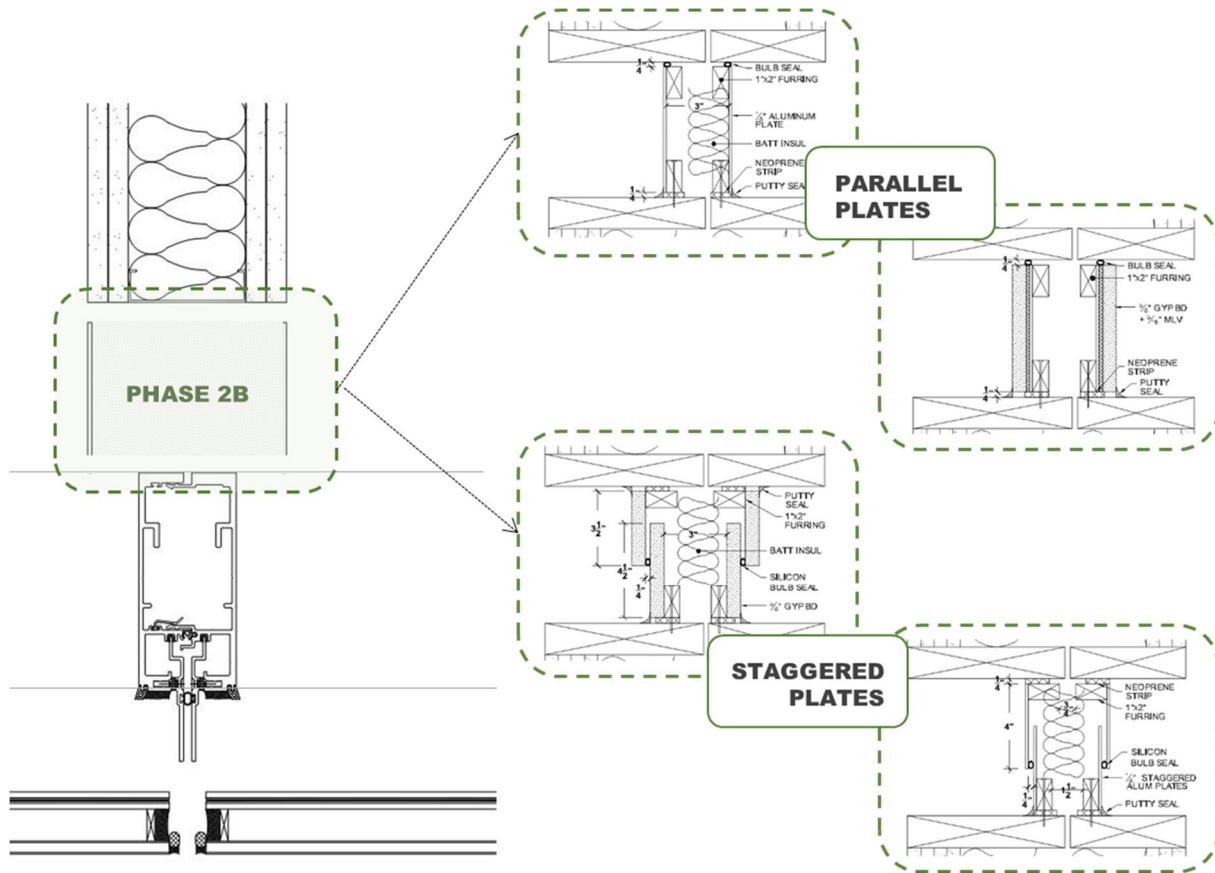

FIGURE 4-45: PLAN DIAGRAM OF ACOUSTIC CONCEPT CONNECTIONS MEASURED IN PHASE 2B

The acoustic concept details are representative of building materials used in practice to either conceal gaps between a partition and a mullion (i.e. parallel plates) or to create a configuration that enables façade deflections (i.e. staggered plates) (Figure 4-45).

The staggered plates are specifically indicative of resilient male-female connections which occur in practice to satisfy deflection conditions in at least 2-axis: Horizontal deflections normal to the façade (See A in Figure 4-46) and minimal off axis deflections accommodated by the 1/4" airspace between plates (See B in Figure 4-46).

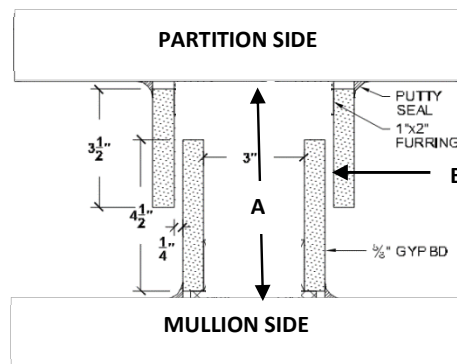

FIGURE 4-46: PLAN DIAGRAM OF STAGGERED PLATE SPECIMEN

4.4.1 PHASE 2B TEST SPECIMEN DESCRIPTION

The primary connection elements used during this test phase were placed into a 6-1/2" x 60-1/2" aperture in the chamber filler wall. Figure 4-47 shows an elevation view of the test specimen inserted into the filler wall.

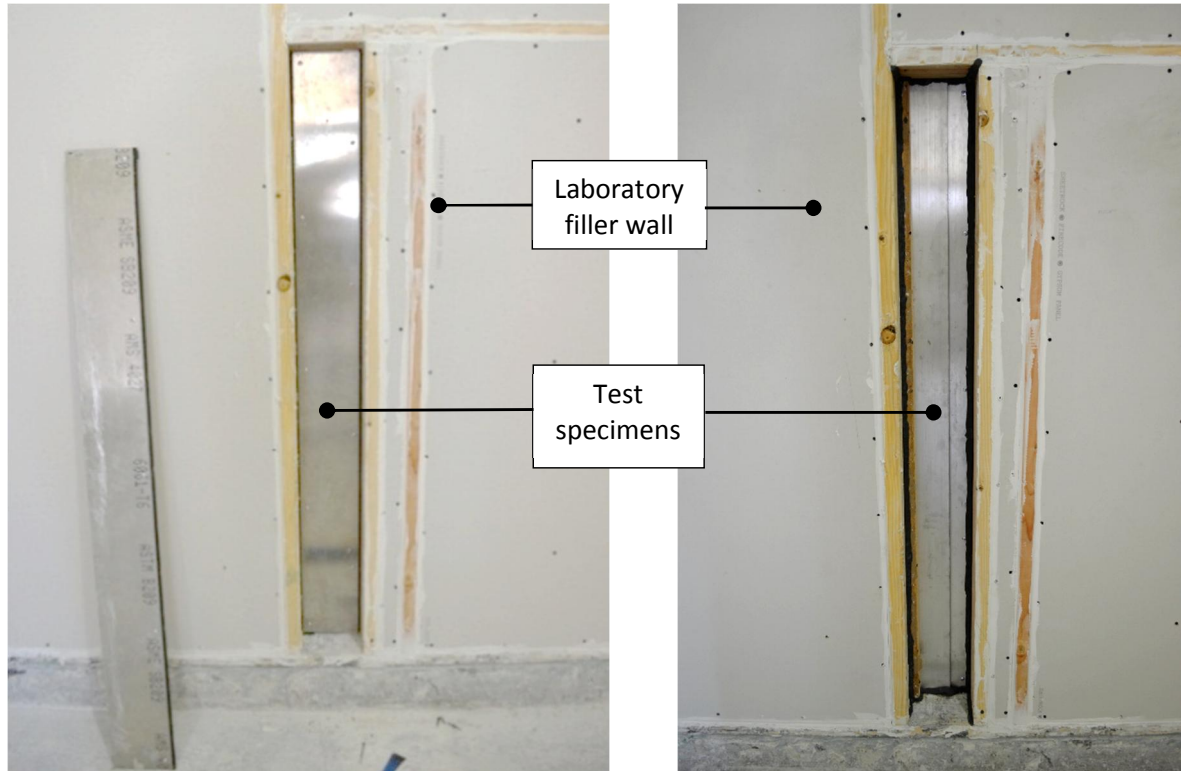

FIGURE 4-47: ELEVATION VIEW OF PHASE 2B TEST SPECIMENS IN FILLER WALL (LEFT – PARALLEL, RIGHT – STAGGERED)

Both test specimens in the figures above show configurations with 1/8" thick aluminum plates (60" x 6") materials. Other materials and seal elements used in this test phase are listed below and are shown in Figure 4-48 and Figure 4-49.

- 1/8" aluminum plates – 60" x 6" and 60"x4"
- 5/8" gypsum wall board – 60" x 6", 60"x4.5" and 60"x3.5"
- 3/16" Mass Loaded Vinyl (MLV) – 60" x 6"
- Mullion Mate Product: (60" height, width 2-7/8" minimum to 3-15/16" maximum opening)
- Mull-it-Over Product: (2) 5' height, 4-1/2" wide
- Neoprene bulb seals
- 3/4" x 1" wood furring strips

Bulb seals were used on the plate conditions to simulate a resilient seal to the glass or mullion. The furring strips were used, especially with the staggered plate condition to structurally attach the strips to the filler wall with neoprene pads. As with all UVM test phases, the horizontal perimeter gap is maintained at 1/4" around all test elements so that no mechanical connection occurs between the specimen and the chamber filler wall. The dimensions of the filler wall aperture were modified for select mullion products tested at the end of the phase.

“Solid Plate” specimen construction



FIGURE 4-48: PHASE 2B CLASS A SPECIMEN CONSTRUCTION OF SOLID PLATE TESTS

“Staggered Plate” specimen construction

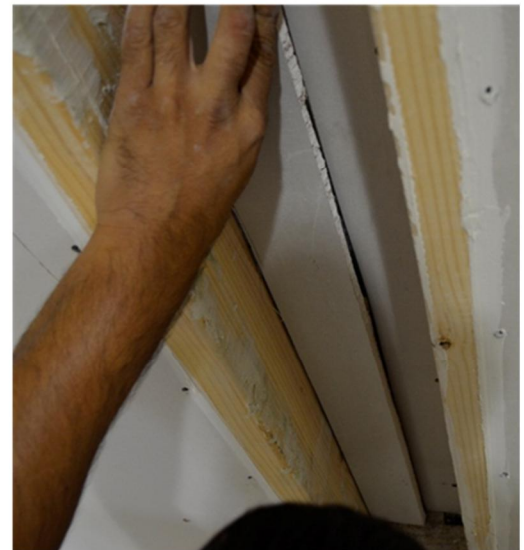
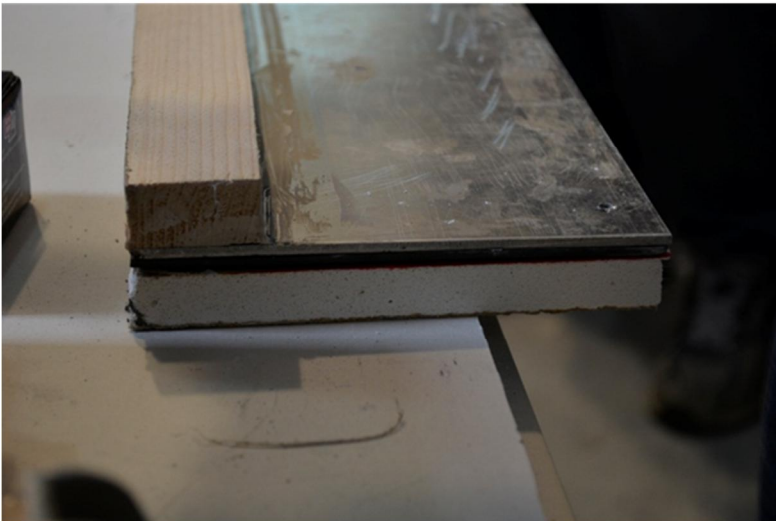

FIGURE 4-49: PHASE 2B CLASS B SPECIMEN CONSTRUCTION OF SOLID PLATE TESTS

4.4.3 PHASE 2B TESTING CLASSIFICATIONS

Tested configurations are categorized and tabulated (TABLE 4-26 TO TABLE 4-28). All assemblies shown are drawn in plan.

TESTED SPECIMENS	Phase 2B Class A: SOLID PLATE
TL13-605 through TL13-619	<p>The parallel plate specimens tested were placed on either side of a 6", 4" or 3" airspace. The plates used in this series consisted of 1/8" aluminum and 5/8" gypsum board. Variations included a resilient layer of 3/16" mass loaded vinyl and/or batt insulation in the cavity. Each plate was cut to dimensions of 6"x60".</p> 

TABLE 4-26: PHASE 2B CLASS A SOLID PLATE DESCRIPTION AND PLAN DRAWING

TESTED SPECIMENS	Phase 2B Class B: STAGGERED PLATE
TL13-620 through TL13-629	<p>The set up and variations to the staggered plate test specimens were similar to the solid plate series. The exception is that the plate materials were broken to allow a 2" overlap between plates offset by 1/4" airspace.</p> 

TABLE 4-27: PHASE 2B CLASS A STAGGERED PLATE DESCRIPTION AND PLAN DRAWING

TESTED SPECIMENS	Phase 2B Class C: Product Tests (Mullion Mate® and Mull-it-over®)
TL13-630 through TL13-633	<p>Pre-manufactured products were tested for Transmission Loss performance. These tests were measured in isolation and as a composite with the unitized vertical curtain wall mullion.</p> <p>The Mullion Mate® product is tested with and without a mullion.</p> <p>The Mull-it-over® product is tested in Phase 2A with a mullion, the product is measured again in Phase 2B without the mullion.</p>

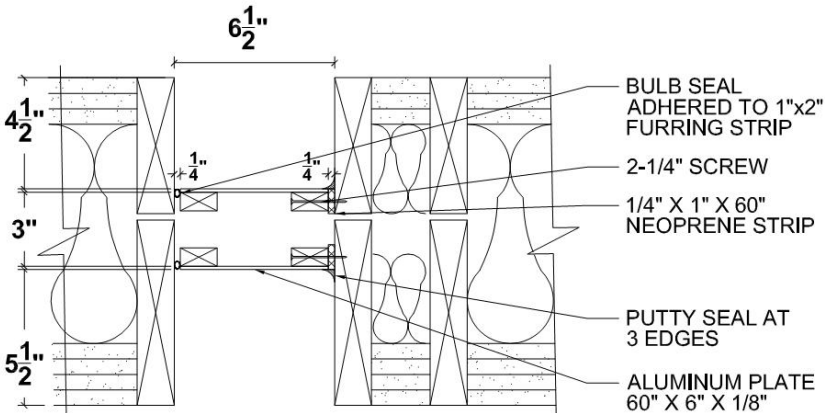
TABLE 4-28: PHASE 2B CLASS C PRODUCT TEST DESCRIPTION AND PLAN DRAWING

The majority of test configurations measured in Phase 2B assume a 3" air cavity so their performance may be directly compared with the mullions tested in Phase 1 and Phase 2a. Parallel plate configurations are measured with 6", 4" and 3" airspaces to be used for different means of comparison.

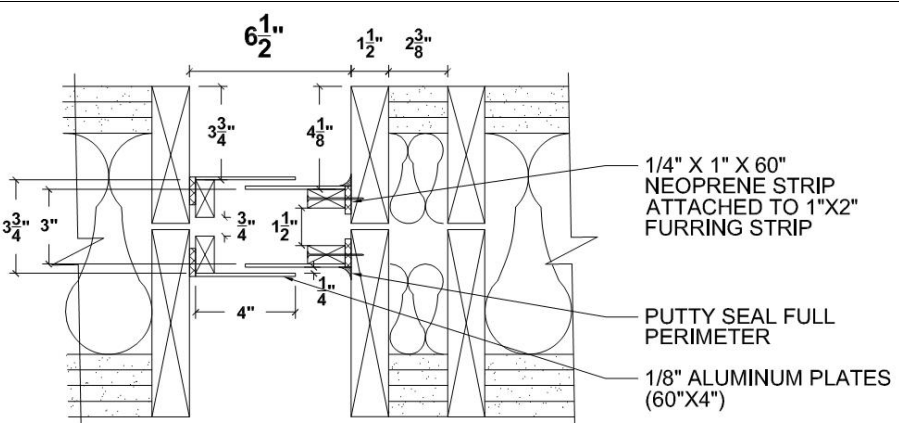
The staggered plate configurations are measured to assess the influence of a labyrinthine sound path from one side to another.

4.4.4 PHASE 2B CLASS A TEST SEQUENCE

Results from the Class A testing sequence are summarized (Table 4-29).

WEAL Test No.	STC	Material Layers [description]	Element Drawing [Plan]
TL13-607	51	<p>[1] 1/8" (3mm) aluminum plate [2] 6" (150mm) air space [3] 1/8" (3mm) aluminum plate</p> <p>[3/4" Bulb Seal at assumed vertical mullion edge, the other 3 edges are sealed with putty]</p>	
TL13-608	51	<p>[1] 1/8" (3mm) aluminum plate [2] 6" (150mm) batt insulation [3] 1/8" (3mm) aluminum plate</p> <p>[3/4" Bulb Seal at assumed vertical mullion edge, the other 3 edges are sealed with putty]</p>	
TL13-610	47	<p>[1] 1/8" (3mm) aluminum plate [2] 4" (100mm) air space [3] 1/8" (3mm) aluminum plate</p> <p>[3/4" Bulb Seal at assumed vertical mullion edge, the other 3 edges are sealed with putty]</p>	
TL13-611	49	<p>[1] 1/8" (3mm) aluminum plate [2] 4" (100mm) batt insulation [3] 1/8" (3mm) aluminum plate</p> <p>[3/4" Bulb Seal at assumed vertical mullion edge, the other 3 edges are sealed with putty]</p>	
TL13-612	44	<p>[1] 1/8" (3mm) aluminum plate [2] 3" (75mm) air space [3] 1/8" (3mm) aluminum plate</p> <p>[3/4" Bulb Seal at assumed vertical mullion edge, the other 3 edges are sealed with putty]</p>	

WEAL Test No.	STC	Material Layers [description]	Element Drawing [Plan]
TL13-613	47	[1] 1/8" (3mm) aluminum plate [2] 3" (75mm) batt insulation [3] 1/8" (3mm) aluminum plate [1/4" Bulb Seal at assumed vertical mullion edge, the other 3 edges are sealed with putty]	
TL13-614	46	[1] 1/8" (3mm) aluminum plate [2] 3/16" (5 mm) MLV layer [3] 3" (75mm) air space [4] 3/16" (5 mm) MLV layer [5] 1/8" (3mm) aluminum plate [1/4" Bulb Seal at assumed vertical mullion edge, the other 3 edges are sealed with putty]	
TL13-615	48	[1] 1/8" (3mm) aluminum plate [2] 3/16" (5 mm) MLV layer [3] 3" (75mm) batt insulation [4] 3/16" (5 mm) MLV layer [5] 1/8" (3mm) aluminum plate [1/4" Bulb Seal at assumed vertical mullion edge, the other 3 edges are sealed with putty]	
TL13-616	45	[1] 5/8" (16 mm) gypsum board plate [2] 3" (75mm) air space [3] 5/8" (16 mm) gypsum board plate [1/4" Bulb Seal at assumed vertical mullion edge, the other 3 edges are sealed with putty]	
TL13-617	48	[1] 5/8" (16 mm) gypsum board plate [2] 3" (75mm) batt insulation [3] 5/8" (16 mm) gypsum board plate [1/4" Bulb Seal at assumed vertical mullion edge, the other 3 edges are sealed with putty]	

WEAL Test No.	STC	Material Layers [description]	Element Drawing [Plan]
TL13-618	50	<ul style="list-style-type: none"> [1] 5/8" (16 mm) gypsum board plate [2] 3/16" (5 mm) MLV layer [3] 3" (75mm) batt insulation [4] 3/16" (5 mm) MLV layer [5] 5/8" (16 mm) gypsum board plate <p>[3/4" Bulb Seal at assumed vertical mullion edge, the other 3 edges are sealed with putty]</p>	
TL13-619	47	<ul style="list-style-type: none"> [1] 5/8" (16 mm) gypsum board plate [2] 3/16" (5 mm) MLV layer [3] 3" (75mm) air space [4] 3/16" (5 mm) MLV layer [5] 5/8" (16 mm) gypsum board plate <p>[3/4" Bulb Seal at assumed vertical mullion edge, the other 3 edges are sealed with putty]</p>	

TABLE 4-29: PHASE 2B CLASS A, STC TEST RESULTS, AND SPECIMEN DESCRIPTION

4.4.4.1 TL OF ALUMINUM PLATES, 6" AND 3" AIR SPACE

The TL of aluminum plates tested with 6" and 3" airspaces (Figure 4-50).

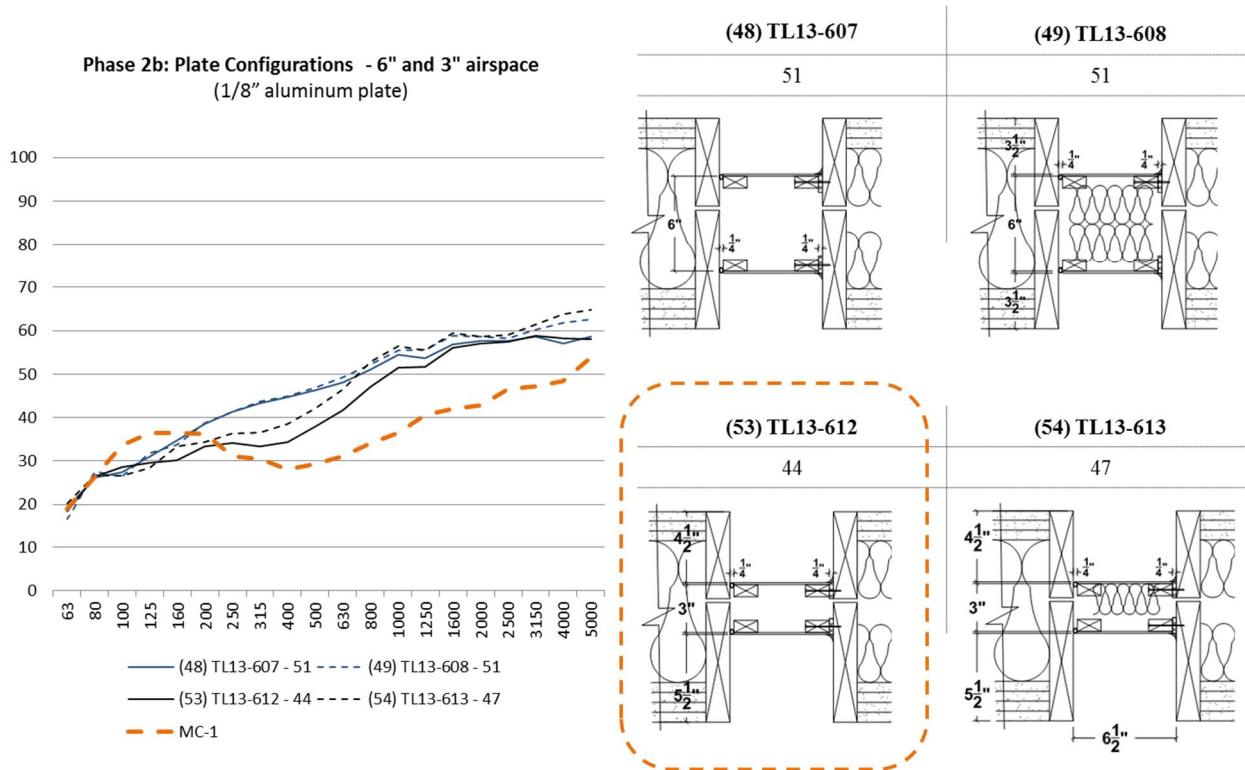

FIGURE 4-50: TL of "PARALLEL PLATES" WITH 6" AND 4" AIR SPACES

*UNTREATED MULLION BASE CASE, MC1

The measured unitized vertical mullion is 3" wide (TL13-311, Figure 4-51) and is compared with TL13-612, also 3" wide.

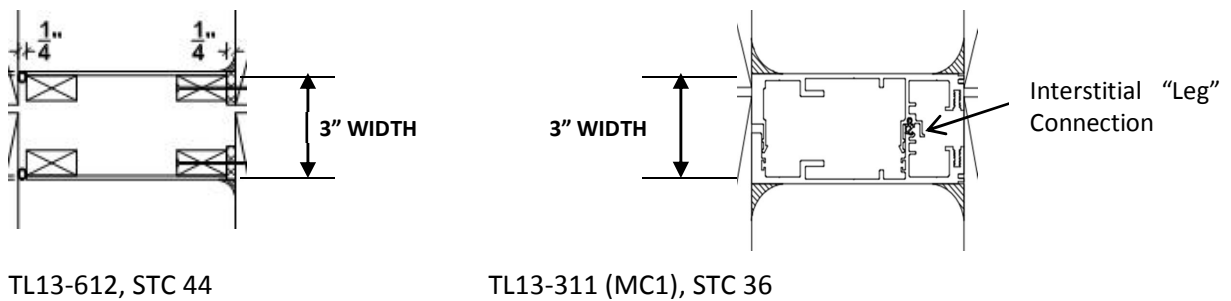

FIGURE 4-51: PLAN DRAWING OF CONNECTION ELEMENT TL13-612 (LEFT) AND UNITIZED MULLION TL13-311 (RIGHT)

The TL spectrum of TL13-612 is significantly higher than MC1 (TL13-311) (Figure 4-50). This indicates that the structural bridging at the internal "leg" connection within the cavity of the unitized mullion is significantly reducing the TL performance. The improved TL performance of specimen TL13-612 may be

influenced by the acoustically separated aluminum plates (i.e. non-bridged) and the plate stiffness from the wood battens.

4.4.4.2 TL OF ALUMINUM AND GYPSUM BOARD PLATES, 3" AIR SPACE

The TL performance of the aluminum and gypsum board plates are plotted with Phase 1 mullions(MC-1) TL13-311, (28) TL13-404 and (17) TL13-325 as building materials are common between the test sequences.

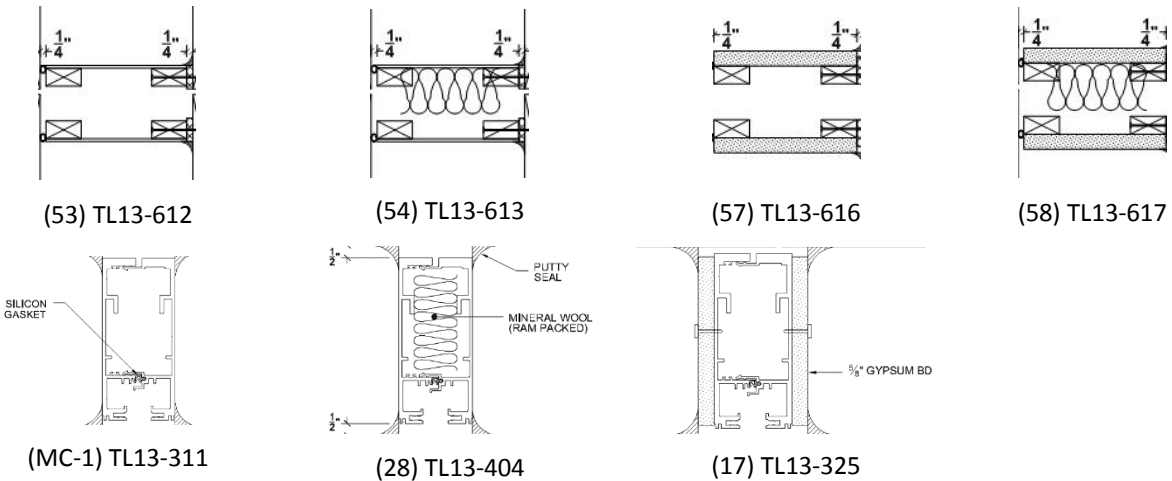
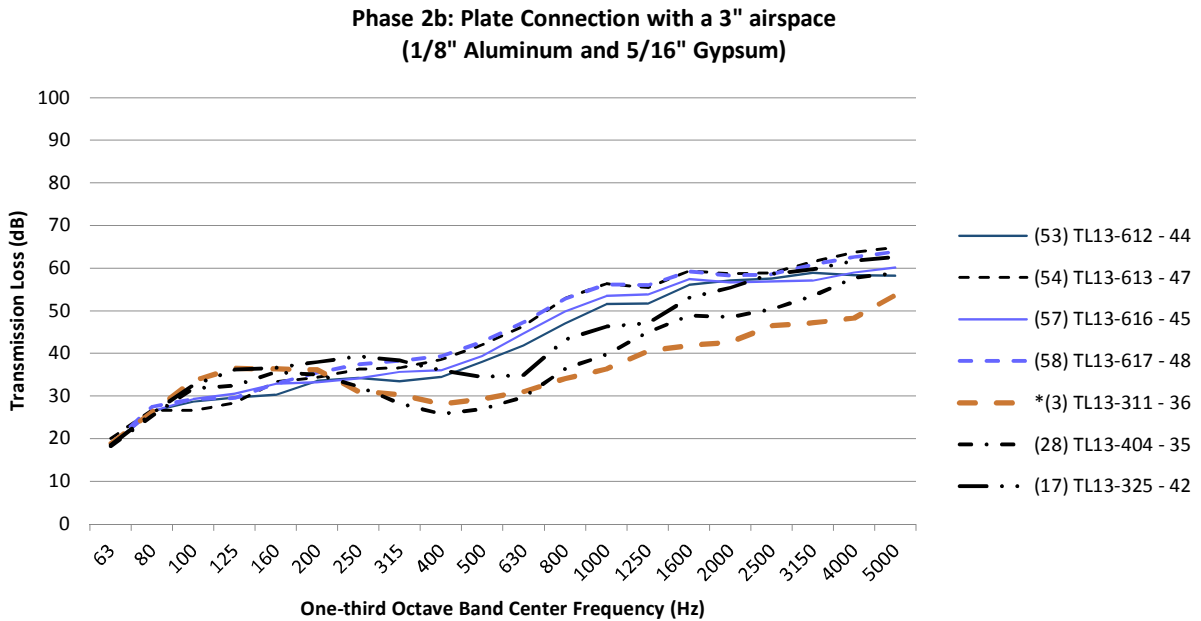

FIGURE 4-52: PHASE 2B ALUMINUM AND GYPSUM BOARD PLATE RESULTS

*UNTREATED MULLION BASE CASE, MC1

Several observations can be drawn with reference to Figure 4-52:

- The TL performance of all parallel plate connections shown perform higher than mullions. This indicates that the connection element is not necessarily controlling the overall transmission loss of a curtain wall. The lower mullion performance may be influenced by the factors discussed in the section above, i.e. interstitial leg connections in the mullion cavity as well as structural stiffness.
- The average parallel plate performance is 11 dB STC more than MC-1. The average performance of parallel plate configurations filled with mineral fiber is 9 dB STC above the phase 1 Mullion test TL13-404.
- The mullion specimens from earlier phases perform better at lower frequencies (below 250Hz) and the parallel plate specimens generally outperform the mullions above 250 Hz.
- Gypsum board plates perform higher than aluminum plates. This is likely due to the heavier weight of the gypsum board.

4.4.4.3 TL OF ALUMINUM AND GYPSUM BOARD PLATE WITH MLV DAMPING LAYER, 3" AIR SPACE

The TL performance of select Phase 2B connections are plotted with Phase 1 mullions (10) TL13-318 and (13) TL13-321 as building materials are common between the two test phases (Figure 4-53).

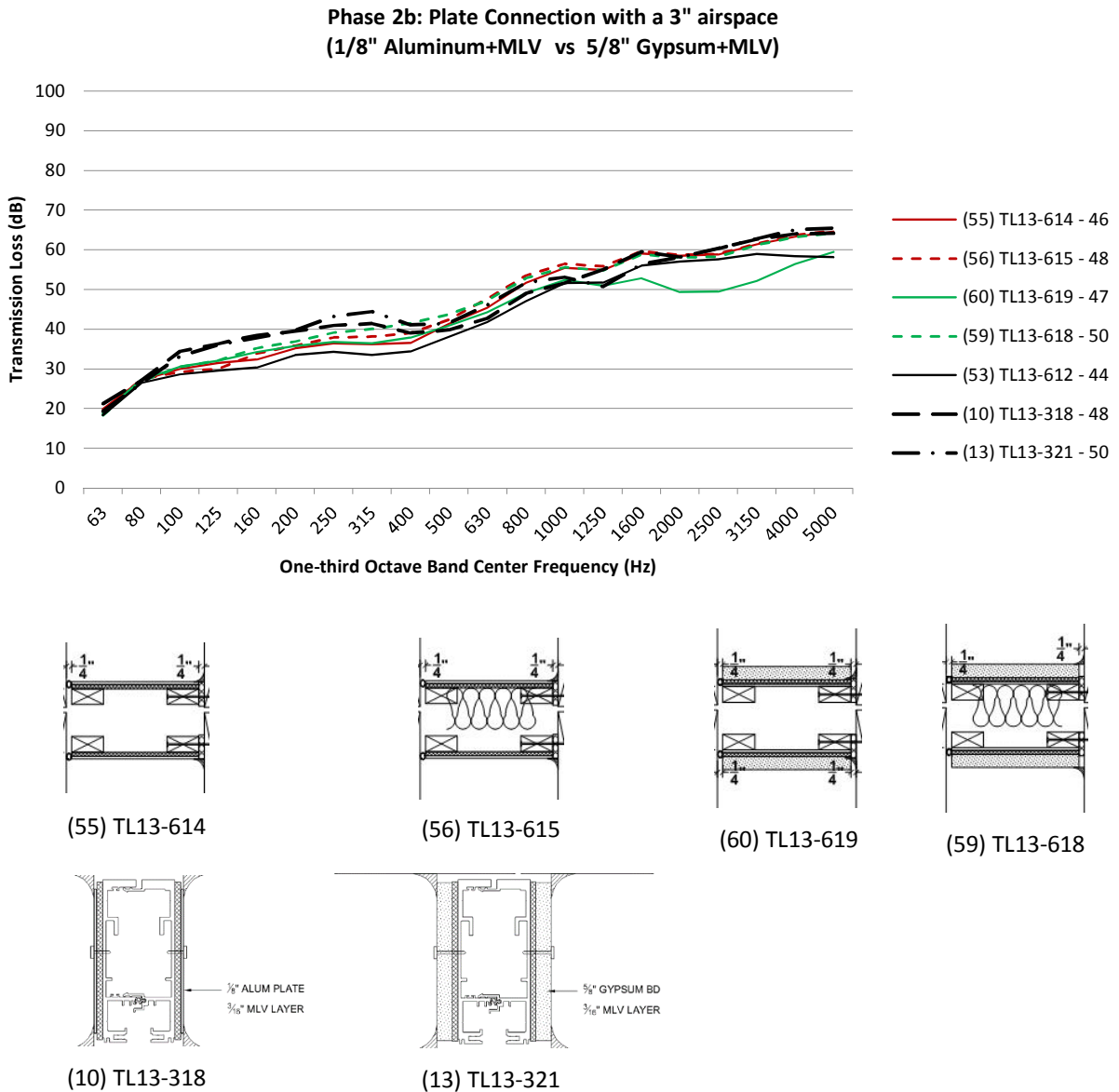

FIGURE 4-53: PHASE 2B CLASS A: ALUMINUM OR GYPSUM BOARD PLATE WITH AN MLV DAMPING LAYER

Several observations can be drawn with reference to Figure 4-53:

- The performance of the mullions and plates are closer in performance. This indicates that the MLV damping layer has a significant influence on the performance of the mullion. The Phase 1 mullions are within 1 - 2 dB STC points of the connection elements.

- At frequencies below 400Hz the mullions outperform the plate specimens. This result is unexplained; however it may be an indication that the difference in structural stiffness between mullions and plate specimens should be examined further.
- Similar to the previous section, the gypsum board plates performed slightly higher than the aluminum plates; however the performance between materials is much closer with the introduction of batt within the parallel plate cavity.

4.4.5 PHASE 2B CLASS B TEST SEQUENCE

Results from the Class B testing sequence are summarized (Table 4-30).

WEAL Test No.	STC	Material Layers [description]	Element Drawing [Plan]
TL13-620	22	<p>[1] 5/8" (16 mm) staggered gyp bd plates [2] 3" (75mm) air space [3] 5/8" (16 mm) staggered gyp bd plates</p> <p>[Putty seal at all filler wall edges] [1/4" air space between staggered plates]</p>	
TL13-621	37	<p>[1] 5/8" (16 mm) staggered gyp bd plates [2] 3" (75mm) batt insulation [3] 5/8" (16 mm) staggered gyp bd plates</p> <p>[Putty seal at all filler wall edges] [1/4" air space between staggered plates]</p>	
TL13-622	51	<p>[1] 5/8" (16 mm) staggered gyp bd plates [2] 3" (75mm) batt insulation [3] 5/8" (16 mm) staggered gyp bd plates</p> <p>[Putty seal at all filler wall edges] [1/4" bulb seal between staggered plates, closing air gap]</p>	
TL13-623	44	<p>[1] 5/8" (16 mm) staggered gyp bd plates [2] 3" (75mm) air space [3] 5/8" (16 mm) staggered gyp bd plates</p> <p>[Putty seal at all filler wall edges] [1/4" bulb seal between staggered plates, closing air gap]</p>	

WEAL Test No.	STC	Material Layers [description]	Element Drawing [Plan]
TL13-624	47	[1] 5/8" (16 mm) staggered gyp bd plates [2] 3" (75mm) air space [3] 5/8" (16 mm) staggered gyp bd plates [Putty seal at all filler wall edges] [1/4" bulb seal between staggered plates, closing air gap; 2 receiver/1 source]	<p>Labels: PUTTY SEAL, 1x2" FURRING, 3 1/2", 3", 4 1/2", 1/4", 5/8" GYP BD, SILICON BULB SEAL.</p>
TL13-625	20	[1] 1/8" (3mm) aluminum plate [2] 3" (75mm) air space [3] 1/8" (3mm) aluminum plate [Putty seal at all filler wall edges] [1/4" air space between staggered plates]	<p>Labels: NEOPRENE STRIP, 1x2" FURRING, 1/4", 3/4", 4", 1/2", 1/4", 1/8" STAGGERED ALUM PLATES, PUTTY SEAL.</p>
TL13-626	31	[1] 1/8" (3mm) aluminum plate [2] 3" (75mm) batt insulation [3] 1/8" (3mm) aluminum plate [Putty seal at all filler wall edges] [1/4" air space between staggered plates]	<p>Labels: NEOPRENE STRIP, 1x2" FURRING, BATT INSUL, 1/4", 3/4", 4", 1/2", 1/4", 1/8" STAGGERED ALUM PLATES, PUTTY SEAL.</p>
TL13-627	49	[1] 1/8" (3mm) aluminum plate [2] 3" (75mm) batt insulation [3] 1/8" (3mm) aluminum plate [Putty seal at all filler wall edges] [1/4" bulb seal between staggered plates, closing air gap]	<p>Labels: NEOPRENE STRIP, 1x2" FURRING, SILICON BULB SEAL, 1/4", 3/4", 4", 1/2", 1/4", 1/8" STAGGERED ALUM PLATES, PUTTY SEAL.</p>
TL13-628	47	[1] 1/8" (3mm) aluminum plate [2] 3" (75mm) air space [3] 1/8" (3mm) aluminum plate [Putty seal at all filler wall edges] [1/4" bulb seal between staggered plates, closing air gap]	<p>Labels: NEOPRENE STRIP, 1x2" FURRING, SILICON BULB SEAL, 1/4", 3/4", 4", 1/2", 1/4", 1/8" STAGGERED ALUM PLATES, PUTTY SEAL.</p>

WEAL Test No.	STC	Material Layers [description]	Element Drawing [Plan]
TL13-629	48	<p>[1] 1/8" (3mm) aluminum plate</p> <p>[2] 3" (75mm) air space</p> <p>[3] 1/8" (3mm) aluminum plate</p> <p>[Putty seal at all filler wall edges]</p> <p>[1/4" bulb seal between staggered plates, closing air gap; 2 receiver/1 source]</p>	

TABLE 4-30: PHASE 2B CLASS B, STC TEST RESULTS AND SPECIMEN DESCRIPTION

4.4.5.1 TL OF STAGGERED PLATE - ALUMINUM

The TL performance of the aluminum staggered plates are plotted in Figure 4-54.

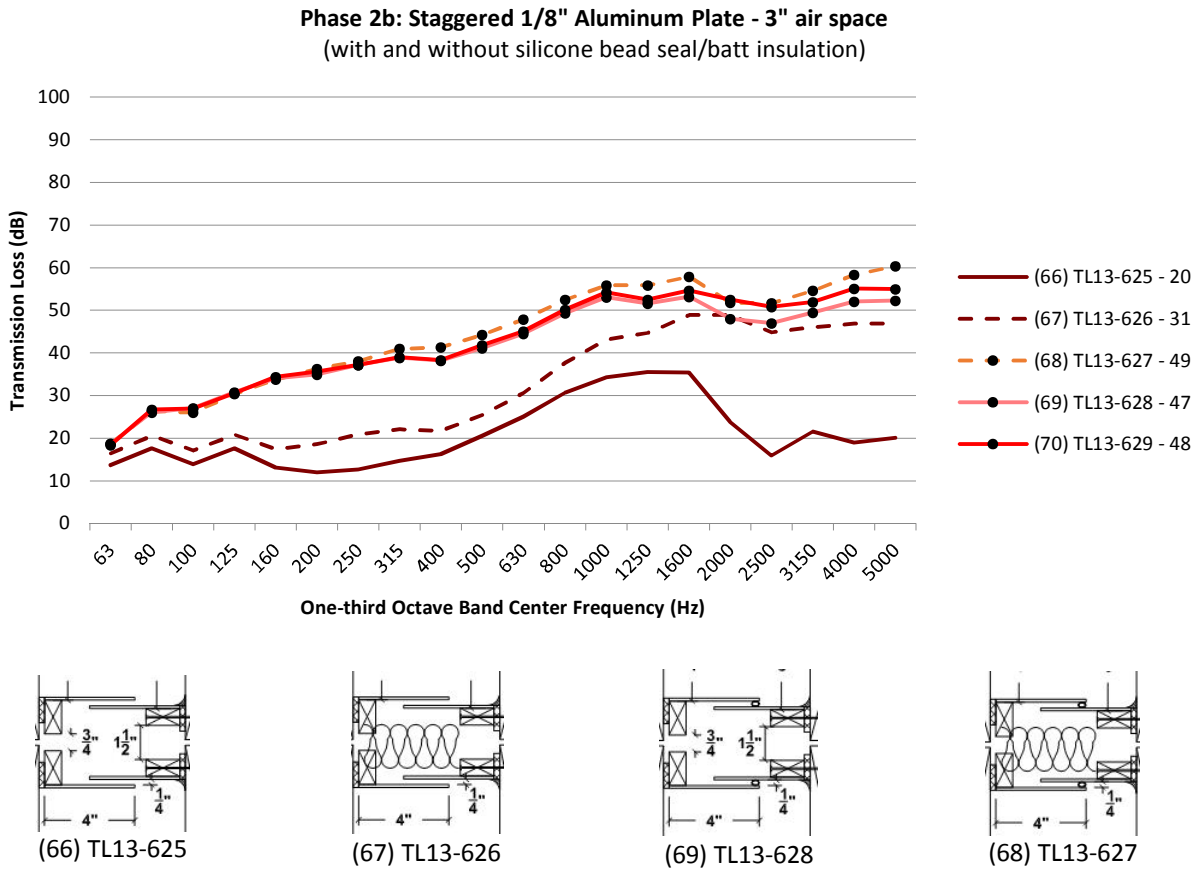
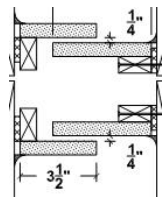
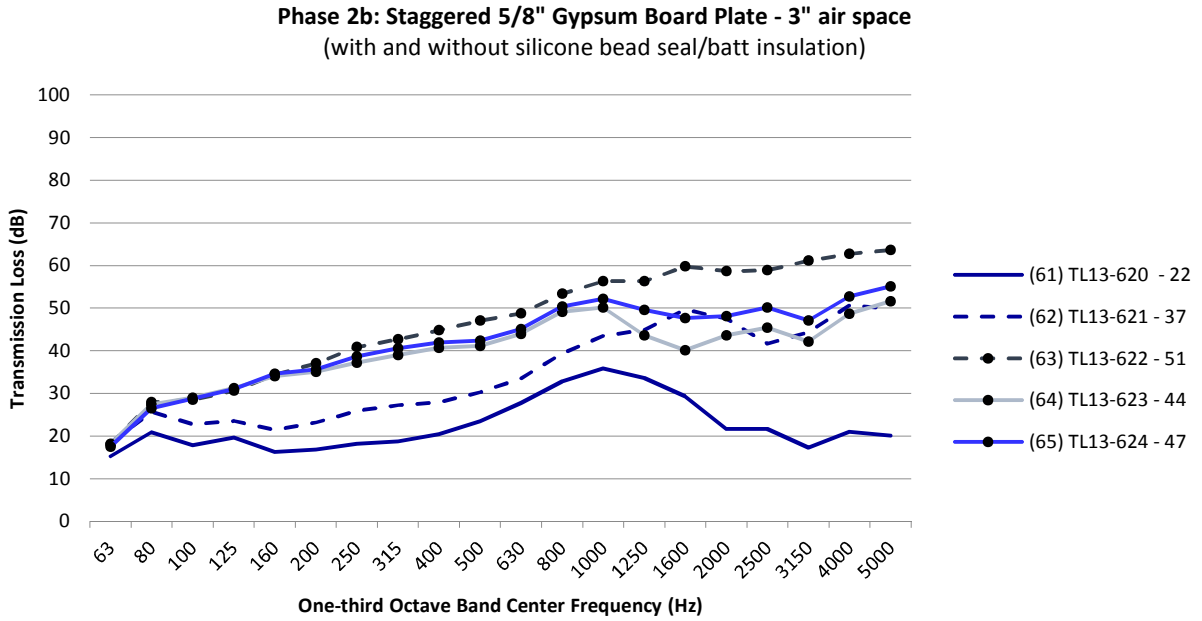

FIGURE 4-54: PHASE 2B CLASS B, MLV COMPOSITE WITH ALUMINUM OR GYPSUM BOARD PLATE

4.4.5.2 TL OF STAGGERED PLATE - GYPSUM BOARD

The TL performance of the aluminum staggered plates are plotted in Figure 4-55.



(61) TL13-620

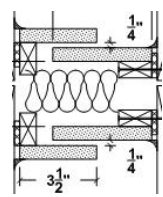

(62) TL13-621

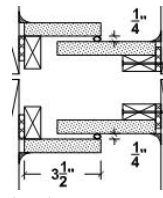

(64) TL13-623

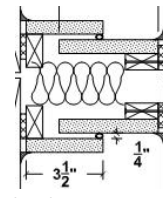

(63) TL13-622

FIGURE 4-55: PHASE 2B CLASS B: MLV COMPOSITE WITH ALUMINUM OR GYPSUM BOARD PLATE

TL13-622 is the highest performing connection element.

4.4.6 PHASE 2B CLASS C TEST SEQUENCE

Results from the Class C testing sequence are summarized (Table 4-31).

WEAL Test No.	STC	Material Layers [description]	Element Drawing [Plan]
TL13-630	23	[1] 1/16" (1.5mm) aluminum plate [2] 2-3/16" (55.5mm) batt insul [3] 1/16" (1.5mm) aluminum plate [Mullion Mate® assembly isolated] [wet seal at all vertical edges]	
TL13-631	30	[1] 1/16" (1.5mm) aluminum plate [2] 3" (75mm) air space [3] 1/16" (1.5mm) aluminum plate VEC: 3-1/2" Mullion Mate® [wet seal at all vertical edges] [TL13-311 mullion used]	
TL13-632	31	[1] 1/16" (1.5mm) aluminum plate [2] 3" (75mm) air space [4] 1/16" (1.5mm) aluminum plate VEC: 3-1/2" Mullion Mate® [wet seal at all vertical edges] [TL13-323 mullion used]	
TL13-633	50	[1] Mull-It-Over® (alum+vinyl+foam) [2] 6" (150mm) air space [3] Mull-It-Over® (alum+vinyl+foam) [overall width 7-1/2" (190mm)]	

TABLE 4-31: PHASE 2B CLASS C, STC TEST RESULTS AND SPECIMEN DESCRIPTION

*VEC (vertical edge condition)

4.4.6.1 MANUFACTURED PRODUCT RESULTS

Mullion Mate®
(Gordon Inc.)

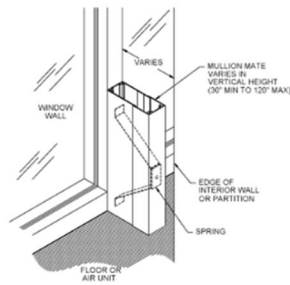

Mull-It-Over®
(Mull-It-Over Products)



FIGURE 4-56: MULLION MATE® (LEFT) AND MULL IT OVER® (RIGHT)

Mullion Mate®

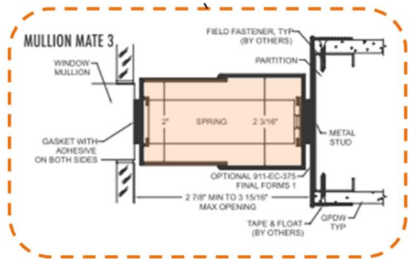
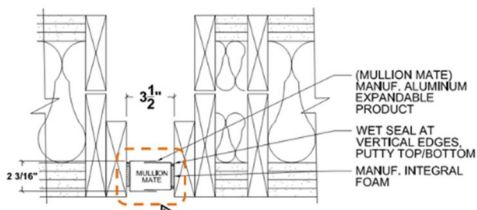

Mull-it-over®

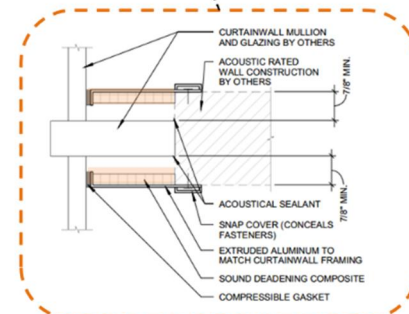
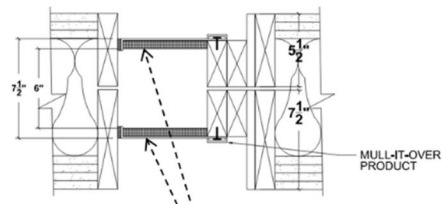

FIGURE 4-57: MULLION MATE (LEFT) AND MULL IT OVER (RIGHT)

4.4.6.2 TL OF MULLION MATE® PERFORMANCE BELOW

The Mullion Mate® product is tested in an isolated condition and then coupled with the lowest and highest performing mullion base cases from phase 1 (Figure 4-58).

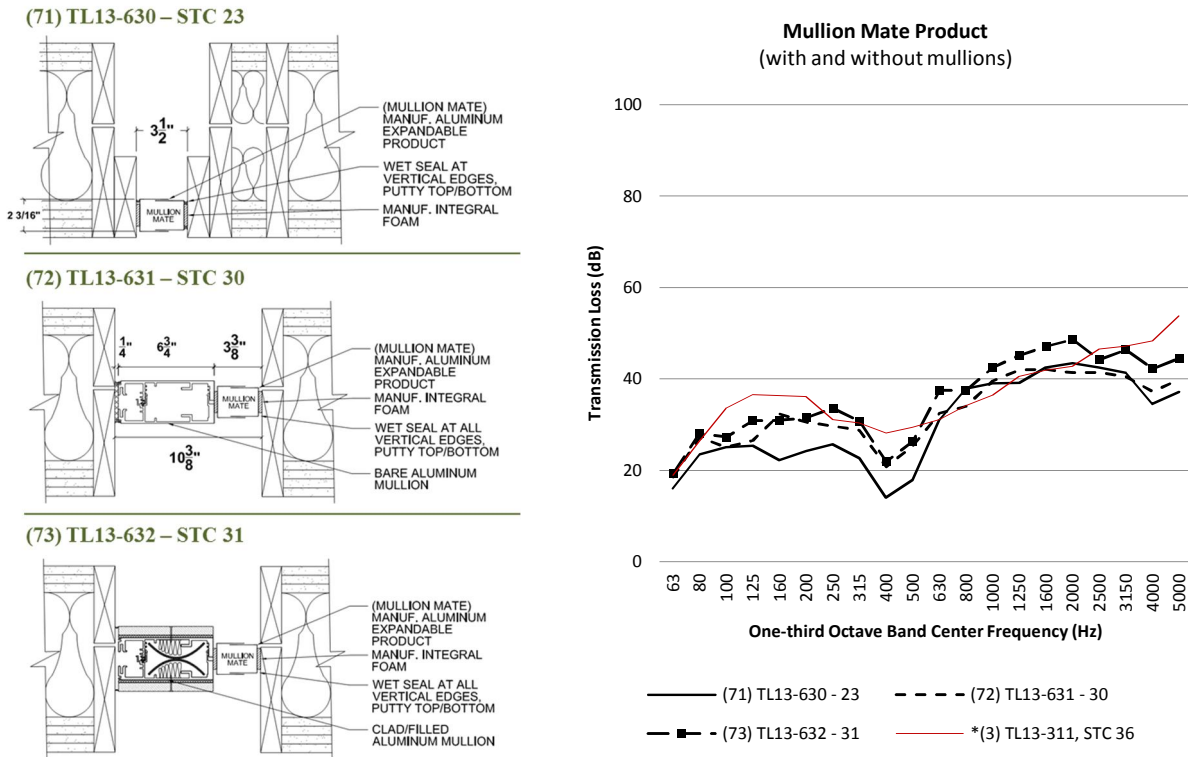

FIGURE 4-58: MULLION MATE (LEFT) AND MULL IT OVER (RIGHT)

*UNTREATED MULLION BASE CASE, MC1

The graph in Figure 4-58 includes the TL overlay of the mullion base case TL13-311. The test measurements with the product perform significantly less than the untreated (hollow and exposed) mullion base case. There is also an unexplained resonance at 400Hz with the product tests.

Similar to test measurements conducted in Phase 1 Class C4, the discrete resonance seen with the product tests reduces the overall STC rating and requires further investigation.

4.4.6.3 MULL-IT-OVER® PERFORMANCE

All the Mull-it-Over Transmission Loss plots for assemblies tested at WEAL in phase 2A and 2B are summarized in Figure 4-59. The tested product in phase 2A (TL13-623) structurally bridges either side of the filler wall with a wood stud and includes a mullion. The product tested during phase 2B (TL13-633) does not include a mullion and is not bridged.

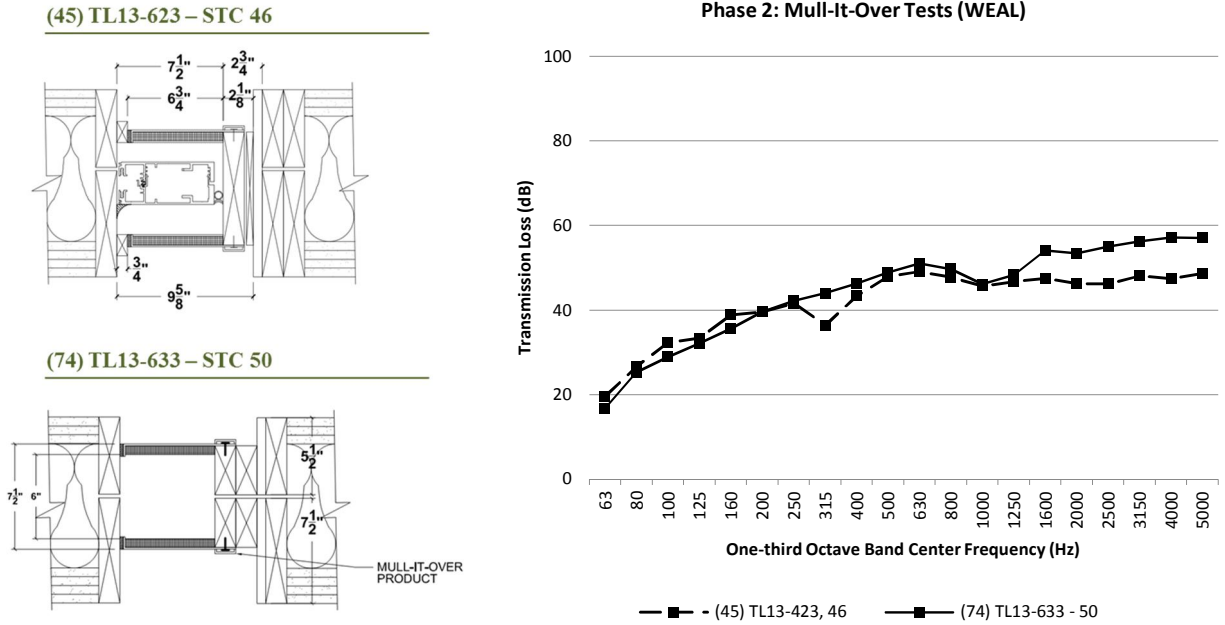

FIGURE 4-59: TRANSMISSION LOSS RESULTS OF THE MULL IT OVER PRODUCT FROM WEAL

4.4.7 PHASE 2B OBSERVATIONS AND CONCLUSION

The following are general observations and field notes based on the TL of the parallel and staggered plates:

- Adding silicone bead seals to create airtight conditions with the staggered plate test sequence (eg. TL13-623) significantly increases the transmission loss better than adding mineral fiber to the cavity (eg. TL13-621).
- Adding batt insulation provides a greater TL improvement with narrow airspaces (3") versus wider airspaces (6")
- The elements with a wider airspace and/or greater mass achieved higher transmission loss performances.
 - (48) TL13-607 and (49) TL13-608 highest performing due to 6" airspace.
 - Gypsum board elements performed higher than similar configuration setups with aluminum plates. This indicates that the denser material property of gypsum board is influencing performance.
- Test (53) TL13-612 resulted in STC 44 performs better than a 3" wide aluminum mullion extrusion (TL13-311) since there is no bridging between each side.
- Highest performing test is (63) TL13-622 with STC 51.
- Batt insulation and seals are significant TL improvement factors; this will influence detailing in practice.
- Lowest performing shows 2 major elements
 - Low mass - indicated by dips at lower frequencies 160 – 630
 - Holes/leaks - indicated by dips at high frequencies, 2.5kHz

The following are conclusions from the product measured in this phase:

- Products that are lighter or narrower than the connected mullion will degrade the overall performance, i.e. Mullion Mate®.
- Products that act like an extension of the demising wall can provide good transmission loss performance; appropriate field assembly construction is critical to avoid leaks or degradation of the overall transmission loss.

In the next phase of testing, no connection detail is added to the curtain wall bay system so that any variable influence will not impact the Transmission loss results.

Analytical studies to be investigated further include:

- Single panel TL comparisons- Mass dependent - single panels generally increase 6 dB per octave.
 - If mass is increased on both sides, the curve shifts up.
 - The specimen starts to act like a single panel (i.e. mullion) when more connections bridge both sides.
- Double Panel TL comparisons - generally increase 10 db per octave.
- Larger hole or leak - the frequency dip in the curve shifts toward low frequency.
- The influence of low frequency wavelengths on small apertures, i.e. 6" aperture
- ¼" perimeter slits may have an influence on the frequency dips.

4.5 PHASE 3 – GLAZING ASSEMBLY ELEMENT

The Phase 3 laboratory tests are the final UVM sound transmission loss measurement sequence (Figure 4-60). Unlike the previous test phases, most significant in this phase is the introduction of the following new elements:

- Insulated glazing unit infill (IGU)
- Upper horizontal mullion (i.e. transom)
- Lower horizontal mullion (i.e. sill)

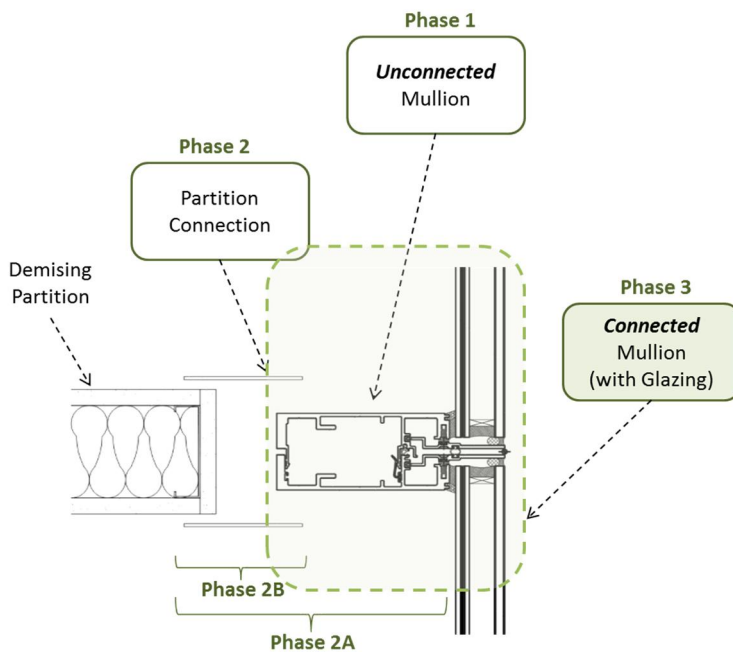

Date March 17 - 20, 2014

Laboratory: WEAL

Specimen: Glazing Element including Mullion and Transom

Dimensions: 8-3/4" depth

Surface Area: 2.92 ft²
(0.27m²)

Transmission: Horizontal

Procedure: ASTM E90-09

Total Tests: 5 airborne, 4 vibration sets

FIGURE 4-60: PHASE 3: PLAN DIAGRAM OF UVM ELEMENTS AND ASSOCIATED TEST PHASES

The composite unitized curtain wall bay assembly includes the unitized vertical and horizontal mullions and the insulated glazing unit (IGU) infill for two adjacent bays. A partition connection element from Phase 2a and 2b was not included in this test phase so that any variable influence at this path is eliminated. A total of five sound transmission loss tests were conducted.

Four sets of vibration tests were also conducted during this phase as part of a linear sequence to study the acoustic energy injection across the multiple elements that comprise the curtain wall. The measurement detail and results are included in Appendix D. Vibration measurements were not conducted in other test phases because the airborne sound transmission loss was discrete for all other elements, whereas the architecture of the curtain wall assembly is inherently composite and vibration measurements give an indication of acoustic energy transmitted to surfaces at the receiving chamber.

4.5.1 PHASE 3 TEST SPECIMEN DESCRIPTION

The unitized glass curtain wall system was tested with three modifications to the center vertical mullion which align directly with select tests in Phase 1 (Figure 4-61):

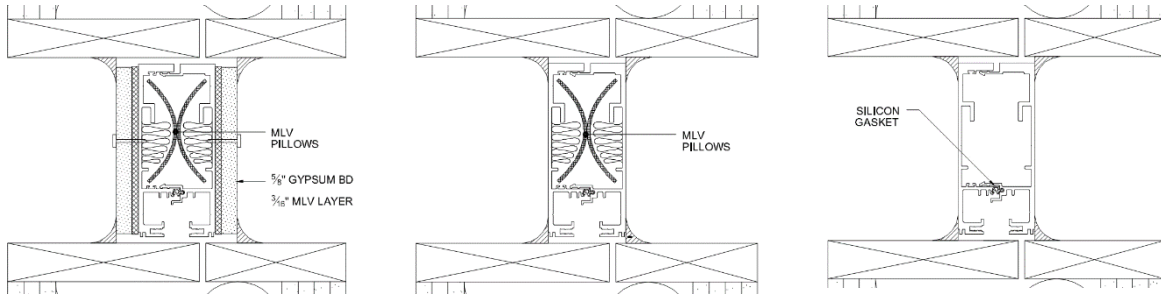

TL13-323, STC 52 (MC-2)²

TL13-316, STC 38

TL13-311, STC 36 (MC-1)¹

FIGURE 4-61: PHASE 1 CONFIGURATIONS USED AS THE CENTER VERTICAL MULLION IN PHASE 3

¹ MC1 (Mullion Control 1): the hollow and exposed mullion tested in isolation during Phase 1 with an STC 36 performance.

² MC2 (Mullion Control 2): the MLV pillow filled mullion with gypsum plus MLV overlaid. The highest performing mullion tested in Phase 1 with an STC 52 performance.

The construction of the testing rig is labor intensive due to the weight of the large scale specimen and design of the semi-anechoic chambers. Therefore the number of tests conducted in this phase were limited to the highest (MC-2) and lowest (MC-1) performing mullions. An opportunity to test a third variation (TL13-316) was possible based on ease of disassembling the MC-2 mullion.

The vibration measurements procedure and results are described in Appendix D. The vibration measurements were conducted to explore the energy radiation passing from the source to receiving chambers at three curtain wall surfaces:

- [1] The insulated glazing unit (z-axis),
- [2] The lower horizontal mullion (y-axis), and
- [3] The center vertical mullion (x-axis).

4.5.2 PHASE 3 TEST CHAMBER CONSTRUCTION

Two gypsum board wall enclosures (Chamber 3S and 3R in Figure 4-62) were built within the WEAL source and receiving chambers in order to conduct the airborne and vibration test series. These smaller semi-anechoic chambers, 3S chamber at the source side and 3R chamber at the receiving side are both semi-anechoic. The envelope of the chambers was designed to enclose the outboard side of the curtain wall system as seen in Figure 4-62. The intent of this integral chamber was to simulate an *in situ* installation where direct sound transmitting directly through the IGU would be absorbed by the atmosphere.

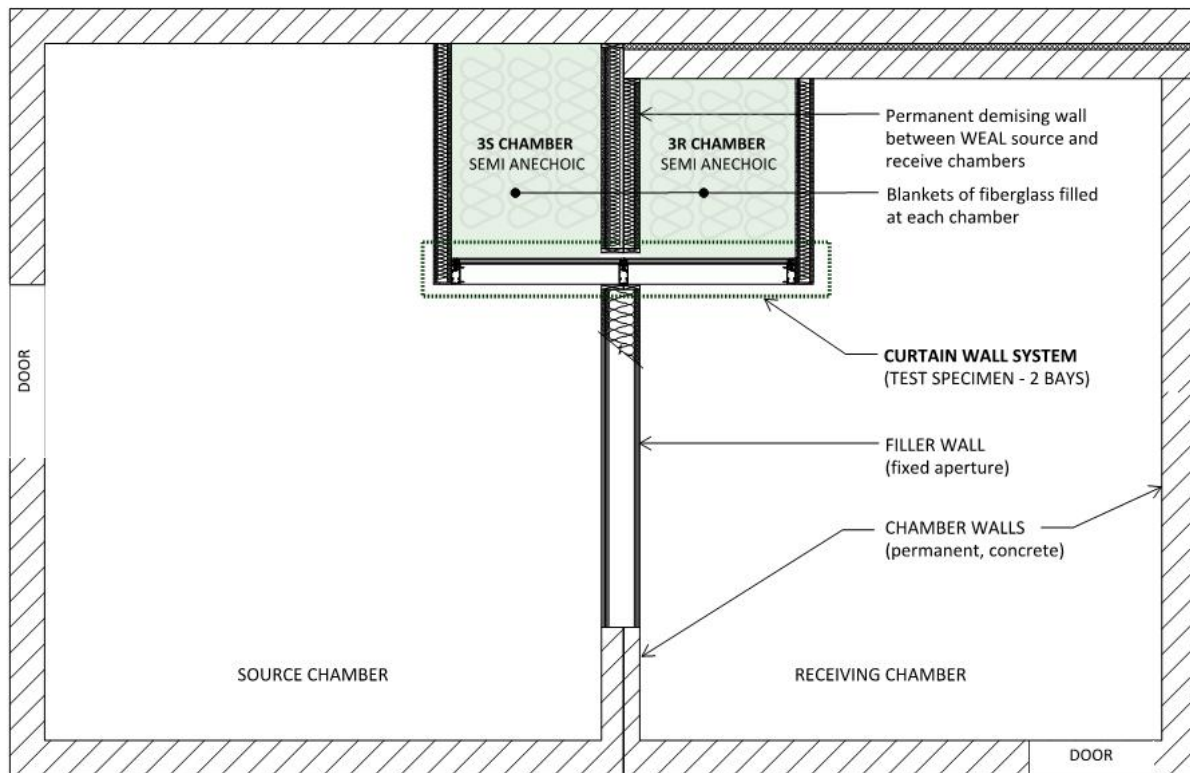

FIGURE 4-62: COUPLED SEMI-ANECHOIC CHAMBERS 3S AND 3R SHOWN IN PLAN WITHIN THE MAIN WEAL CHAMBERS.

The follow is a description of Chambers 3S and 3R and the curtain wall specimen (Figure 4-63 and Figure 4-66).

- 3S Cubic Volume: 210 ft³
- 3R Cubic Volume: 138 ft³
- Absorption: 3S/3R chambers filled with mineral wool and fiber glass (approximately 15 batt layers per chamber)
- Specimen Weight: 335 lbs one curtain wall bay (without mullion fill or overlaid modifications)
- Filler wall aperture: 7" x 60" (includes depth of mullion and backer rod/wet seal, not IGU depth)



FIGURE 4-63: CURTAIN WALL BAY INSERTED INTO THE APERTURE OF THE FILLER WALL



FIGURE 4-64: CURTAIN WALL PLACED AND CENTERED IN THE FILLER WALL.



FIGURE 4-65: CHAMBER 3S (BUILT WITHIN THE WEAL SOURCE CHAMBER)



FIGURE 4-66: CHAMBER 3R (BUILT WITHIN THE WEAL RECEIVING CHAMBER)

The perimeter edge of the curtain wall was spaced by 1/4" thick neoprene and sealed with backer rod and acoustic caulking (This is the perimeter seal condition uniform at all test phases.)

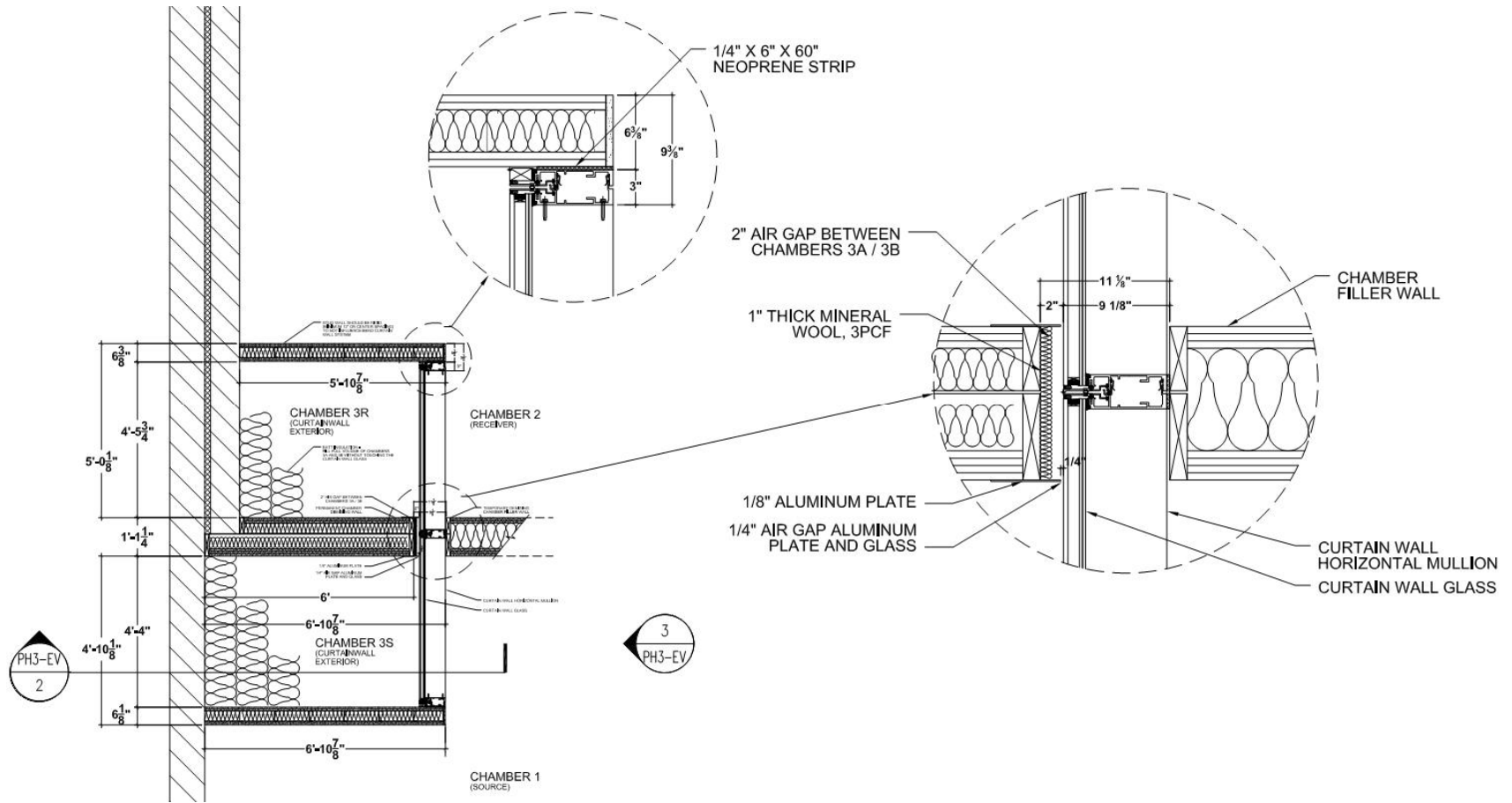

FIGURE 4-67: CHAMBER 3S AND 3R PLAN DRAWINGS AND ACOUSTIC DETAILS

The fiberglass insulation filled the 3S and 3R chambers from floor to ceiling. The curtain wall system sat on a wood bulkhead platform and mounted on neoprene (Figure 4-68 and Figure 4-69).

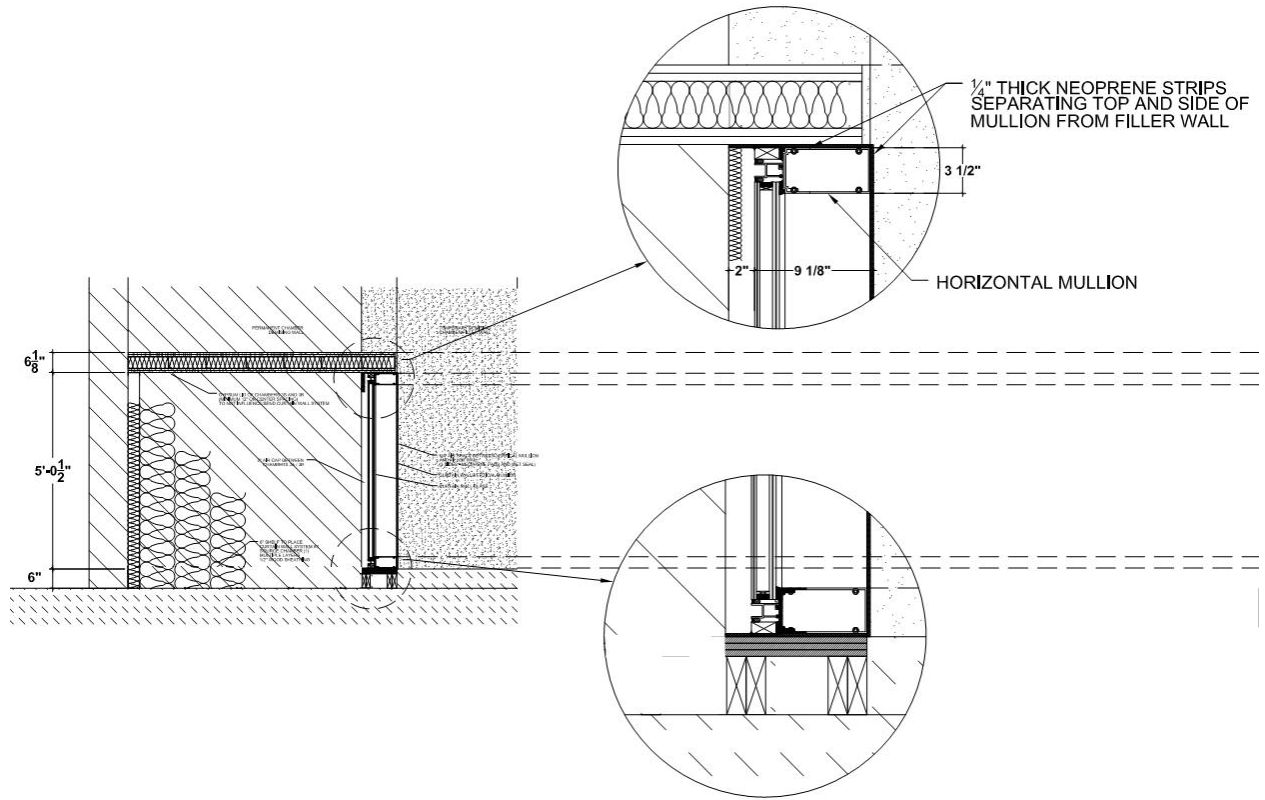

FIGURE 4-68: WEAL CHAMBER [SECTION]

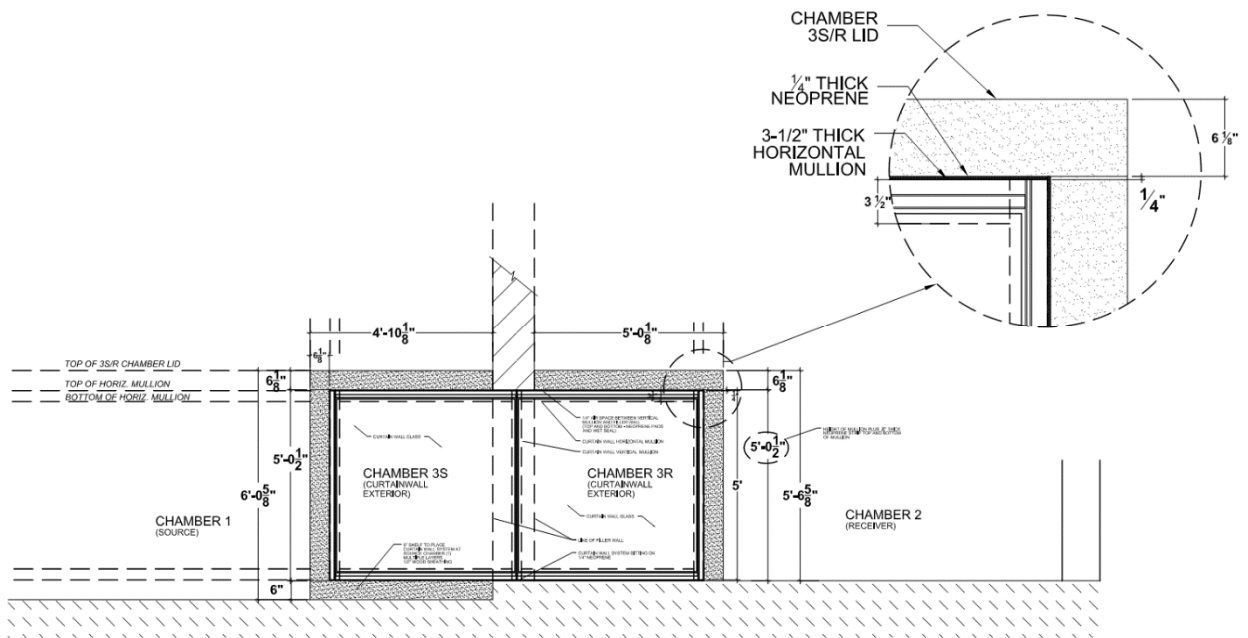

FIGURE 4-69: WEAL CHAMBER [ELEVATION]

4.5.3 PHASE 3 TEST SEQUENCE

Summarized below are single figure STC ratings for the Phase 3 configurations (Table 4-32).

WEAL Test No.	STC	Material Layers [description]	Element Drawing [Plan]
Ph3 [MC2] TL14-167	42	Applying center vertical mullion configuration: TL13-323 (STC 52) [overclad (gyp+MLV) and filled (MLV pillows)]	
Ph3 [MC1 _A] TL14-168	37	Applying center vertical mullion configuration: TL13-316 (STC 38) [filled MLV pillows] [measurement taken after overclad was removed]	
Ph3 [MC1] TL14-170	32	Applying center vertical mullion configuration: TL13-311 (STC 36)	
TL14-171	32	TL13-311 STC 36 [Receiving chamber (3S) removed]	

TABLE 4-32: PHASE 3 STC TEST RESULTS

The transmission loss calculation per ASTM E90 did not use modified cubic volumes at the source and receiving chambers of the WEAL facility. The TL and STC estimates ignore the cubic volume of the 3S and 3R chambers.

For test specimen TL14-167, the MLV pillow infill extended the entire length of the center vertical mullion, i.e. past the depth of the horizontal mullion elements. However, the overlaid only extended to the exposed sides of the center vertical mullion and terminated where the horizontal mullion intersected.

4.5.4 PHASE 3 SUMMARY

Three primary configurations were measured in phase 3:

- STC 32 is the performance of the curtain wall system with the MC 1 configuration at the center vertical mullion.
- STC 42 is the performance of the curtain wall system with MC 2 configuration at the center vertical mullion.
- STC 38 is the performance of the curtain wall system with a center vertical mullion filled with MLV pillows.

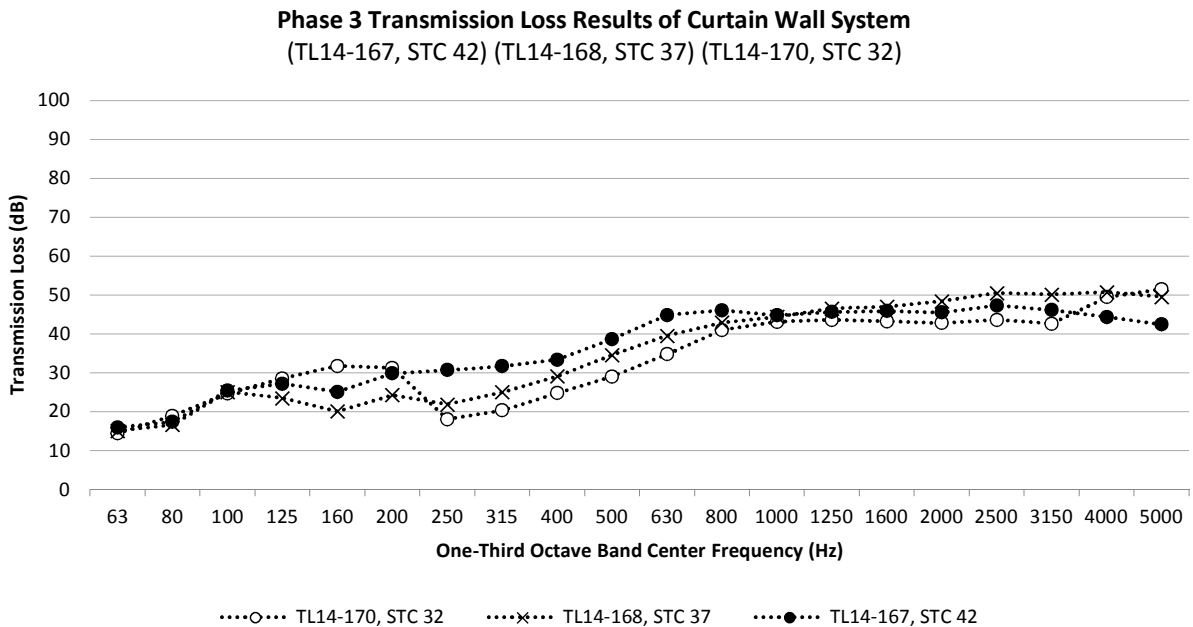

FIGURE 4-70: CHAMBER 3S AND 3R PLAN DRAWINGS AND ACOUSTIC DETAILS

Subjective observations when evaluating acoustic leaks with the rigid stethoscope at the receiving side of the specimen:

- Audible energy at the IGU significantly lower than energy at the mullion and horizontal mullions.
- Significantly greater acoustic energy at the horizontal mullions (upper and lower) than any other structural part of the specimen.
- Audible low frequency energy at the overlaid clad mullion (TL14-167).
- Audible acoustic energy through the 1/2" silicone gasket between the glass and mullion.

4.6 UVM MEASUREMENT SUMMARY

Approximately 80 laboratory tests were conducted in four test phases in accordance with ASTM E90. All measurements were tested in the same type of laboratory conditions so that they may be compared to each other. Test measurements are not intended to simulate an *in situ* condition but instead inform relative changes based on the architectural modifications to each element.

The results from these modifications provide information on what architectural mechanism of the curtain wall architecture are controlling the overall sound isolation performance (as discussed in Chapter 5) and additionally may be applied in practice to improve curtain wall mullions.

Publications similar to the *California Catalog of STC and IIC Ratings for Wall and Floor/Ceiling Assemblies*⁶⁷ or the NRC-CNRC labs *Gypsum Board Walls: Transmission Loss Data*⁶⁸ provide laboratory tests data for batteries of various partition typologies in order to guide designers with performance metrics and relative improvements between wall or floor specimens. The potential value with the measurements conducted in the UVM testing sequence is to make relative comparisons and not necessarily use the face value performance rating. The many modifications to test elements reveal relative changes that can be taken from the laboratory and applied in practice.

FIGURE 4-71 summarizes the range of STC results for each phase.

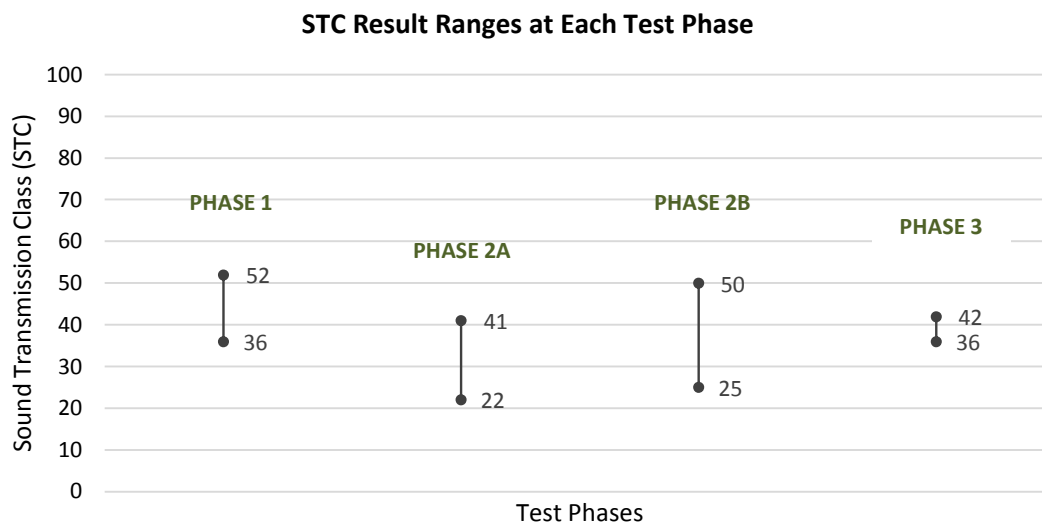

FIGURE 4-71: SUMMARY OF STC RANGES AT EACH UVM TEST PHASE

Transmission loss curves were observed after each testing phase in this chapter. Addition notable observations not mentioned previously include:

- Mullions in Phase 1 and Partition connections in Phase 2B are capable of achieving commensurate TL performances.

⁶⁷ Russell B. DuPree and California. Dept. of Health Services. Office of Noise Control, *Catalog of STC and IIC Ratings for Wall and Floor/Ceiling Assemblies* (Berkeley, California 94704: Office of Noise Control, California Department of Health Services, 1980).

⁶⁸ Halliwell et al., "NRC-CNRC Gypsum Board Walls: Transmission Loss Data."

- Discrete resonances occurred at various phases and were observed to be an indication of material resonance, structural stiffness, or possibly the size of the aperture.

CHAPTER 5 ANALYSIS OF CONTROLLING MECHANISMS AND COMPOSITE TRANSMISSION LOSS

5.1 INTRODUCTION

This chapter describes the analysis of the one-third octave sound transmission loss tests characteristics of the individual elements tested in the Unitized Vertical Mullion (UVM) test method. Critical comparisons are conducted between connected and unconnected mullion conditions in order to characterize mechanisms controlling the overall sound isolation performance. Transmission loss results from the UVM test method are applied to composite predictions including theoretical demising wall performance to establish where diminishing returns may occur between acoustic performance and material construction.

Unconnected mullions are those that were tested independent from the curtain wall system glass, transom, and sills. These were tested in Phase 1.

Connected mullions are those that were tested while mechanically connected to the curtain wall system. These were tested during Phase 3.

Noise reduction (NR) ratings are also evaluated and provide the direct source level difference between the source and receiving chambers. This differs from transmission loss (TL) because it does not include normalizing factors of the specimen size and receiving room absorption.

5.2 CONNECTED VERSUS UNCONNECTED MULLION CONDITIONS

The STC rating of the connected mullions in Phase 3 performed lower than the respective unconnected mullion conditions in Phase 1. The single-figure STC and NR ratings and the one-third octave band sound transmission loss between these two test phases are compared below.

The unconnected mullion conditions specifically studied here are

- Phase 1 Test TL13-311 is named **PH1-MC1** for Mullion Constant 1 and is the independent exposed and hollow mullion condition.
- Phase 1 Test TL 14-323 is named **PH3-MC2** for the Mullion Control 1 and is overlaid with 5/8" thick gypsum wall board and a 3/16" thick limp mass vinyl later including Mall Limp Vinyl (MLV) pillows filled with mineral fiber in the mullion air cavity.

The connected mullion conditions specifically studied here are

- Phase 3 Test TL14-170 is named **PH3-MC1** and is the exposed and hollow mullion condition which forms the center vertical mullion connected to the curtain wall bay test rig with glass.
- Phase 3 Test TL14-167 is named **PH3-MC2** and is the overlaid and filled mullion which forms the center vertical mullion connected the curtain wall bay test rig with glass

5.2.1 COMPARISON: SINGLE FIGURE RATING

Sound transmission class (STC) and noise reduction (NR) ratings are tabulated for lightweight and heavy weight mullions measured with or without the curtain wall glass (Table 5-1).

Lab Test	STC	NIC	Center Vertical Mullion			Unconnected (without glass)	Connected (with glass)
			Exposed/ Hollow	Filled	Overclad/ Filled		
TL13-311	36	49	•			•	
TL14-170	32	47	•				•
TL13-316	38	52		•		•	
TL14-168	37	50		•			•
TL13-323	52	64			•	•	
TL14-167	42	55			•		•

TABLE 5-1: STC AND NR RATING COMPARISON OF SELECT MULLION TESTS FROM PHASE 1 AND PHASE 3

All specimens tested in Phase 3 have a lower STC performance than the respective mullion assemblies tested in Phase 1. The following performance deltas were observed:

- The STC 36 hollow/exposed mullion (TL13-311) performs 4 dB STC points lower when connected to the curtain wall glass and aluminum frame at STC 32 (TL14-170).
- The STC 38 filled mullion (TL13-316) performs 1 dB STC point lower when connected to the curtain wall at STC 37 (TL14-168).
- The STC 52 overclad/filled mullion (TL13-323) performs 10 dB STC points lower when connected to the curtain wall glass system at STC 42 (TL14-167).

It is evident from these results that the addition of the curtain wall glass, sill, and transom to the highest rated specimen (TL13-323) resulted in the greatest reduction in STC and NIC ratings. The conclusion is that one reaches the point of diminishing returns with improving the STC of a mullion once it is part of a composite curtain wall system. The mullion is not the weakest link in this case and the performance is dependent on other components in the system.

Observations between test specimens in Phase1 and Phase 3 are compared in Table 5-2.

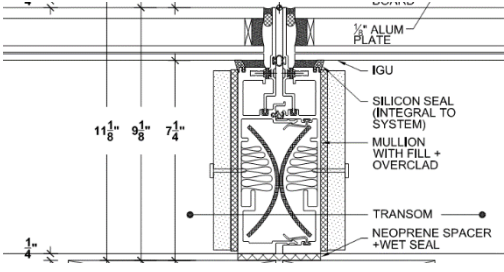
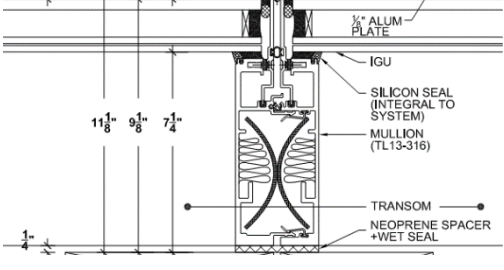
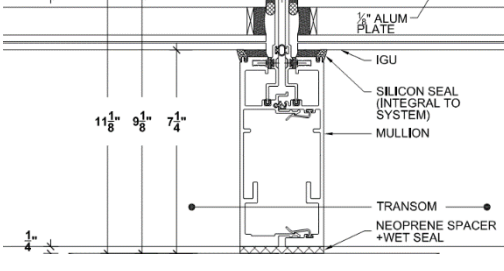
PHASE 3 TEST AND DESCRIPTION	OBSERVATIONS
<p>TL14-167 Plan Drawing of Test Rig</p> 	<p>TL14-167 Observations</p> <p>The heavy center mullion had the greatest performance reduction when connected to curtain wall system than the other lighter mullion assemblies in Phase 3, e.g. TL14-168 and TL14-1470.</p> <p>The significant performance reduction may indicate there are diminishing returns between material assembly and acoustic performance.</p> <p>It is clear that flanking paths within the test rig are at the transom, sill, and glass. It is unclear which of these three elements is contributing to the reduction more significantly, the glass infill or horizontal aluminum members.</p> <p>Future Studies:</p> <p>Future test studies should include modifications to the horizontal mullions to explore STC performance improvement and the influence of the glass connection.</p>
<p>TL14-168 Plan Drawing of Test Rig</p> 	<p>TL14-168 Observations</p> <p>Based on the sound flanking path observations from TL14-167, it appears that</p> <ul style="list-style-type: none"> • sound flanking within the TL14-168 specimen did not significantly reduce the performance of the center vertical mullion assembly (i.e. 1dB STC difference between Phase 1 and 3) <p>The performance between the unconnected version of this mullion and connected version does not vary significantly. This indicates a possible balance between the sound energy through the mullion compared to the curtain wall assembly.</p>
<p>TL14-170 Plan Drawing of Test Rig</p> 	<p>TL14-170 Observations</p> <p>Based on the flanking paths within the TL14-167 test specimen (i.e. at the transom, sill, and glass), it appears that these same paths have contributed to the further reduction of the center vertical mullion in this test rig.</p> <p>Future Studies</p> <p>It is unclear if the center vertical mullion in this specific test rig is controlling the overall STC performance. Two deductions may be considered:</p>

PHASE 3 TEST AND DESCRIPTION	OBSERVATIONS
	<ul style="list-style-type: none"> The vertical mullion is not controlling the STC; the glass and horizontal mullions are reducing the TL of the exposed and hollow mullion. The vertical mullion is controlling the STC; the difference between the mullion alone and the mullion + curtain wall system is less with the previous test, TL14-168 (where the center mullion is almost balanced with the curtain wall system)

TABLE 5-2: OBSERVATIONS OF THREE COMPARABLE TEST SPECIMENS FROM PHASE 1 AND PHASE 3

The other sound flanking paths within the fully connected curtain wall system identified in Phase 3 are glass infill and horizontal mullions (FIGURE 5-1). These paths limit the achievable performance of the *connected* center vertical mullion.

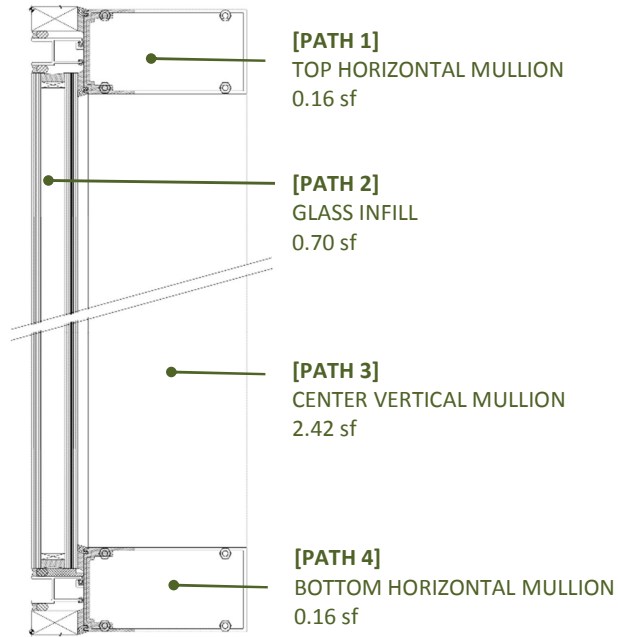

FIGURE 5-1: DRAWING OF MULLION SECTION WITH IDENTIFIED FACE AREAS OF EACH CURTAIN WALL ELEMENT: TRANSOM (0.16 SF), GLASS (0.7 SF), MULLION (2.42 SF), AND SILL (0.16 SF).

5.2.2 NOISE REDUCTION COMPARISON: PHASE 1 AND PHASE 3

The Noise Reduction (NR) spectra between the comparable Phase 1 and Phase 3 unitized vertical mullion test rigs are compared in this section. This intent is to identify performance limitations at specific frequency regions.

5.2.2.1 UNCONNECTED VS CONNECTED EXPOSED/HOLLOW UVM

The NR curves for Ph1-MC1 (TL 13-311) and Ph3-MC1 (TL14-170) are compared below.

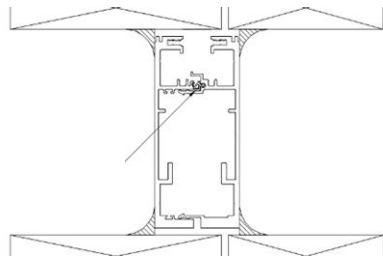

FIGURE 5-2: TL13-311 (UNCONNECTED MULLION)

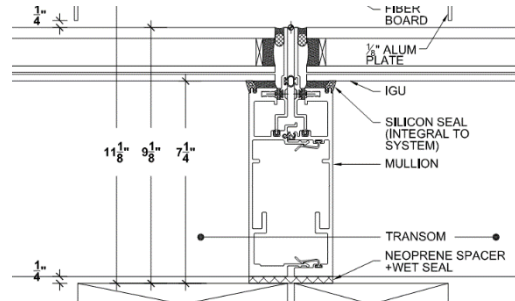

FIGURE 5-3: TL14-170 (CONNECTED MULLION)

NR COMPARISON UNCONNECTED (TL13-311) VS CONNECTED (TL14-170) HOLLOW/EXPOSED CENTER VERTICAL MULLION

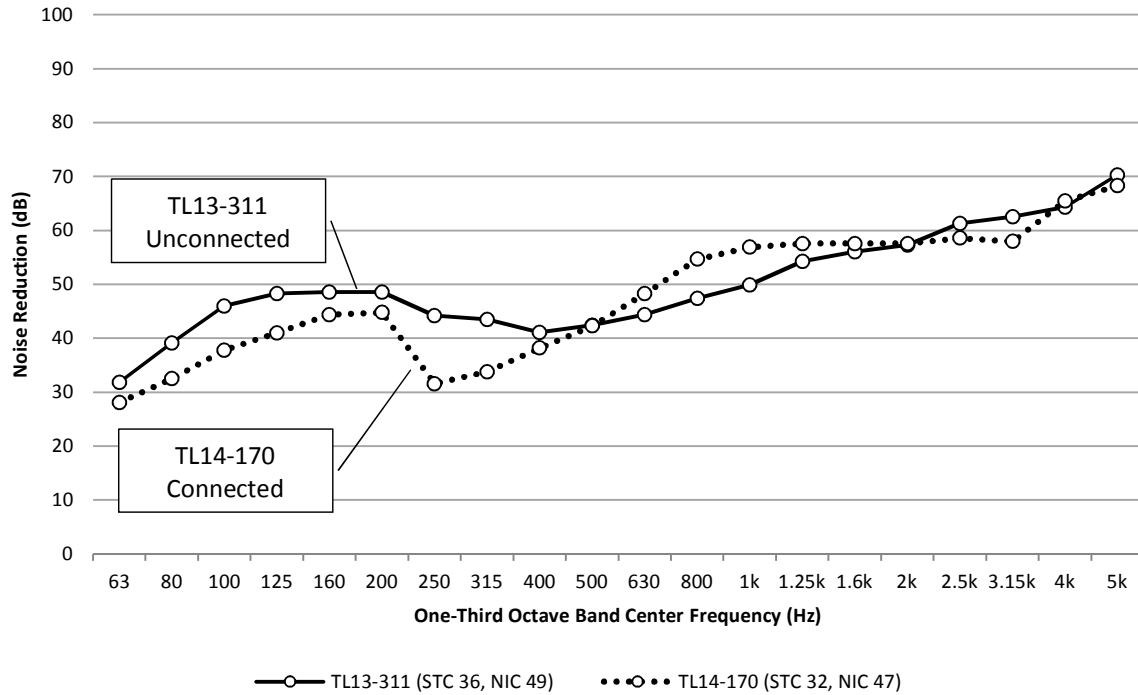

FIGURE 5-4: NOISE REDUCTION SPECTRA BETWEEN TL13-311 AND TL14-170

Trends Observed

It is unclear what is causing the resonance at 250 Hz that is bringing down the performance Ph3-MC1 (TL14-170). This resonance is lower in NR level and frequency than the unconnected vertical mullion from Phase 1, i.e. 400Hz. An examination of this resonance could be a valuable opportunity for future study.

It is observed that in the low frequency region between 63 Hz and 200 Hz that the vibrational waves in the glass and horizontal mullions of TL14-170 are transmitted into the mullion and then into the curtain wall system in the receiving room.

In the frequency region between 630 Hz to 1.6k Hz, the glass and horizontal mullions of TL14-170 may be structurally stiffening (clamping) the center vertical mullion and therefore reducing vibration into the curtain wall bay at the receiving room.

At the high frequency region above 2 kHz, the delta between the curves is small. This may indicate that both the glass and horizontal mullions are loosely coupled to the mullion in this region.

5.2.2.2 UNCONNECTED VS CONNECTED FILLED UVM

The curtain wall specimen Ph3-MC1a (TL14-168) performs 1 dB STC points lower than the mullion specimen of the same weight and assembly, Ph1-MC1a (TL 13-316).

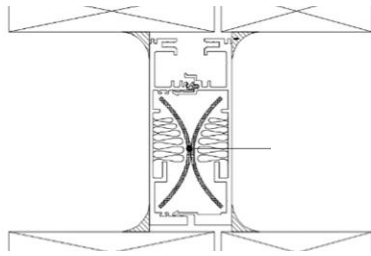

FIGURE 5-5: TL13-316 (UNCONNECTED)

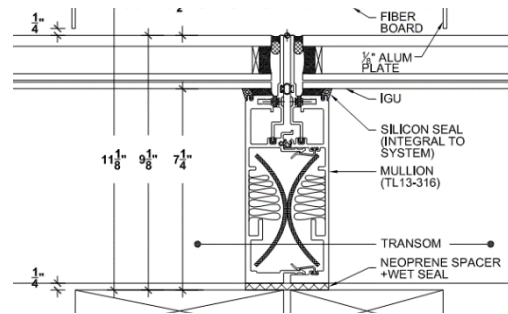

FIGURE 5-6: TL14-168 (CONNECTED)

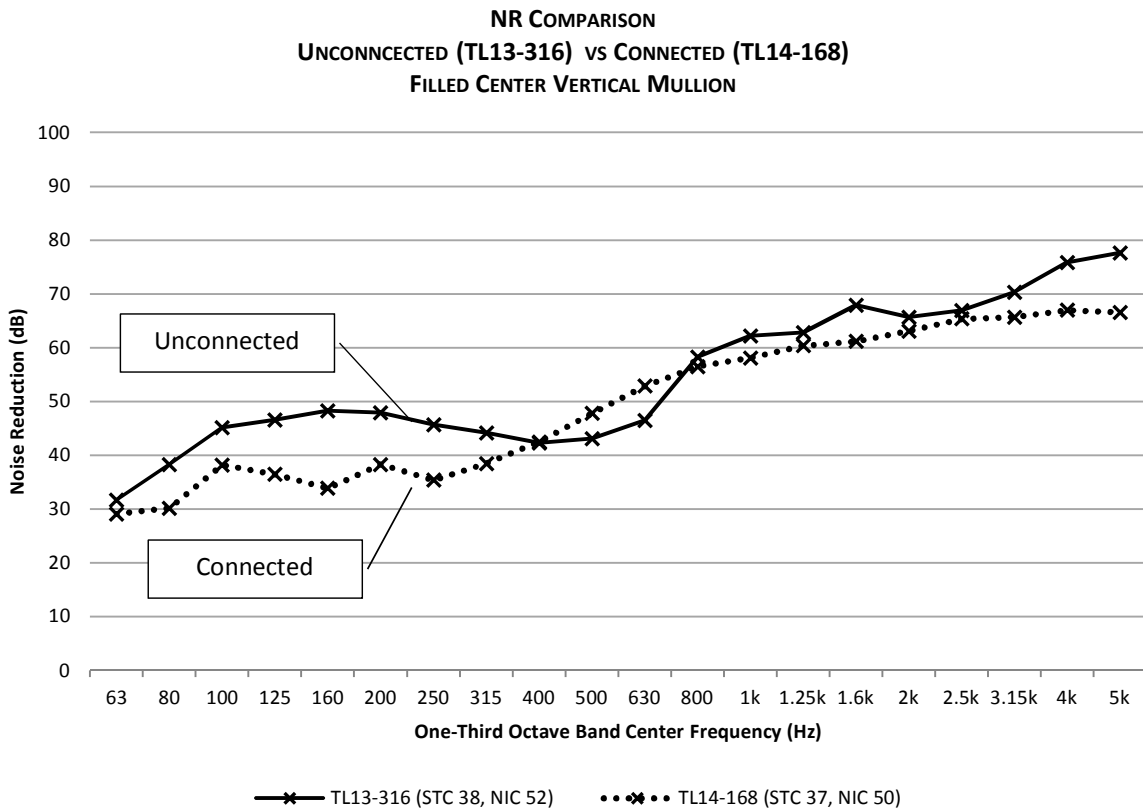

FIGURE 5-7: NOISE REDUCTION SPECTRA BETWEEN TL13-316 AND TL14-168

Trends Observed

Although the TL of the connected mullion in TL14-168 is not as high as the one in the previous test TL14-170, the same trends as the previous comparison occur.

At frequencies below 315 Hz, it is deduced that the connected mullion is performing lower due to the sound energy vibrating through the glass and horizontal mullions. A resonance at 250 Hz is still present.

The noise reduction spectrum from the previous test specimen TL14-170 has a higher performance at low frequencies than the TL14-168 specimen shown here. However at mid-frequencies, TL14-168 performs higher than TL14-170. This is an indication that the added mass and dampening inside the mullion improves the performance.

5.2.2.3 UNCONNECTED VS CONNECTED OVERCLAD/FILLED UVM

The curtain wall specimen Ph3-MC2 (TL14-167) performs 10 dB STC points lower than the mullion specimen of the same weight and assembly, Ph1-MC2 (TL 13-323). The spectral plots of both test curves are overlaid (FIGURE 5-10).

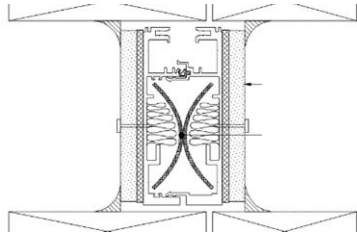

FIGURE 5-8: TL13-323 (UNCONNECTED)

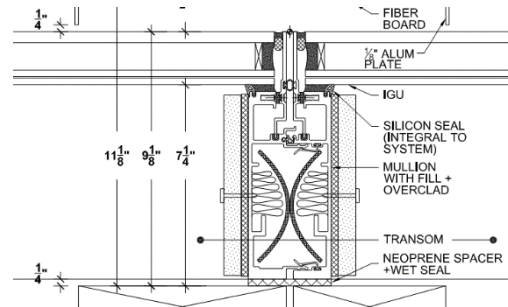

FIGURE 5-9: TL14-167 (CONNECTED)

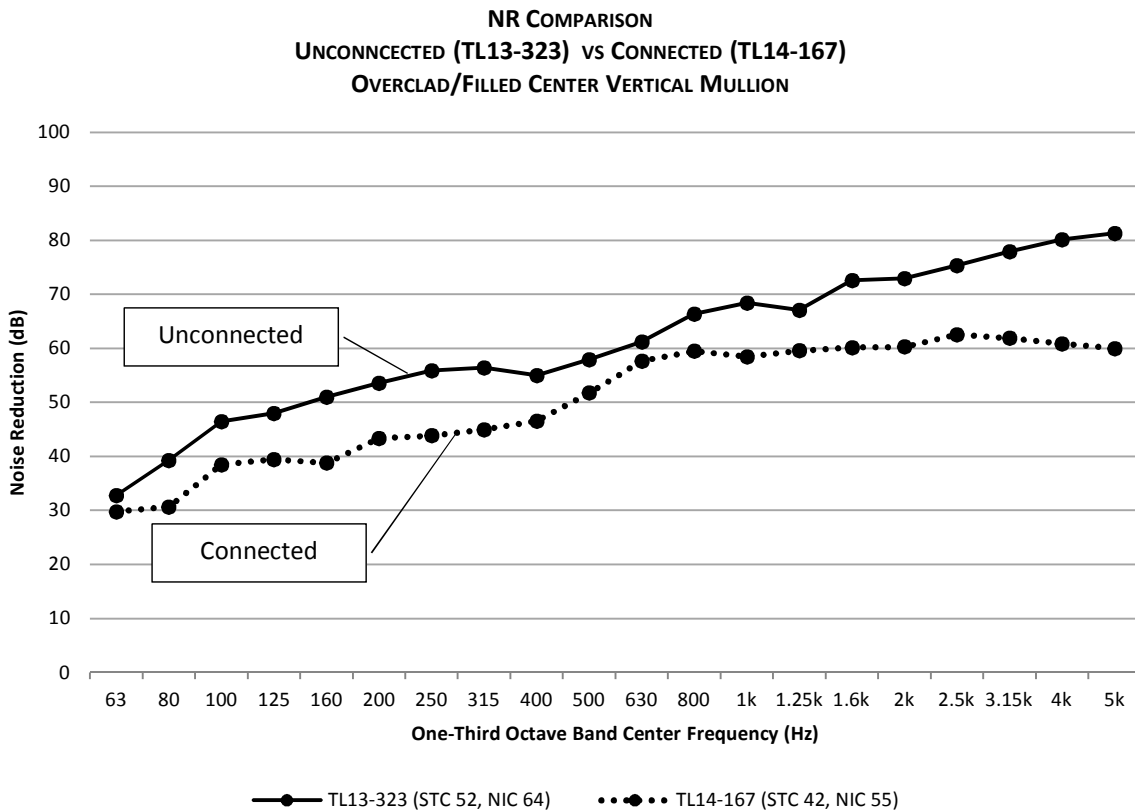

FIGURE 5-10: NOISE REDUCTION SPECTRA BETWEEN TL13-323 AND TL14-167

Trends Observed

The connected mullion has lower noise reduction throughout the entire frequency region, as much as 12 dB at low frequencies and 20 dB at high. The previous comparisons indicated certain mid to high frequency regions where the connected mullion performed slightly higher than the unconnected mullion. In this particular case however, the connected mullion that was mass loaded (with infill and an overclad) is significantly lower than its respective unconnected mullion assembly.

This reveals that the glass and horizontal mullions are reducing the potential sound isolation of the overall Phase 3-MC2 system. These three elements (glass, upper, and lower horizontal mullion) are flanking paths and weaken almost all frequency domains.

The resonance seen in the previous comparisons at 250Hz does not exist with PH3-MC2 (TL14-167). This may be an indication that the added mass and damping at the vertical mullion improve this resonance.

The NR curves indicate that the vertical mullion is closely coupled to the glass and horizontal mullions at 630 Hz.

No overclad could be placed on the connected center vertical mullion where the horizontal mullion joins, i.e. the stack joint. The overall weight of the center vertical mullion is therefore slightly less than the unconnected condition since the overclad was cut back at top and bottom ends of the vertical mullion.

5.2.3 MECHANISMS LIMITING SOUND ISOLATION PERFORMANCE

5.2.3.1 HORIZONTAL MULLIONS AND GLASS

The Noise Reduction graph below compares select unconnected mullion constants from Phase 1:

- TL13-311: The unconnected vertical mullion, exposed and hollow
- TL13-323: The unconnected vertical mullion, overlaid and filled

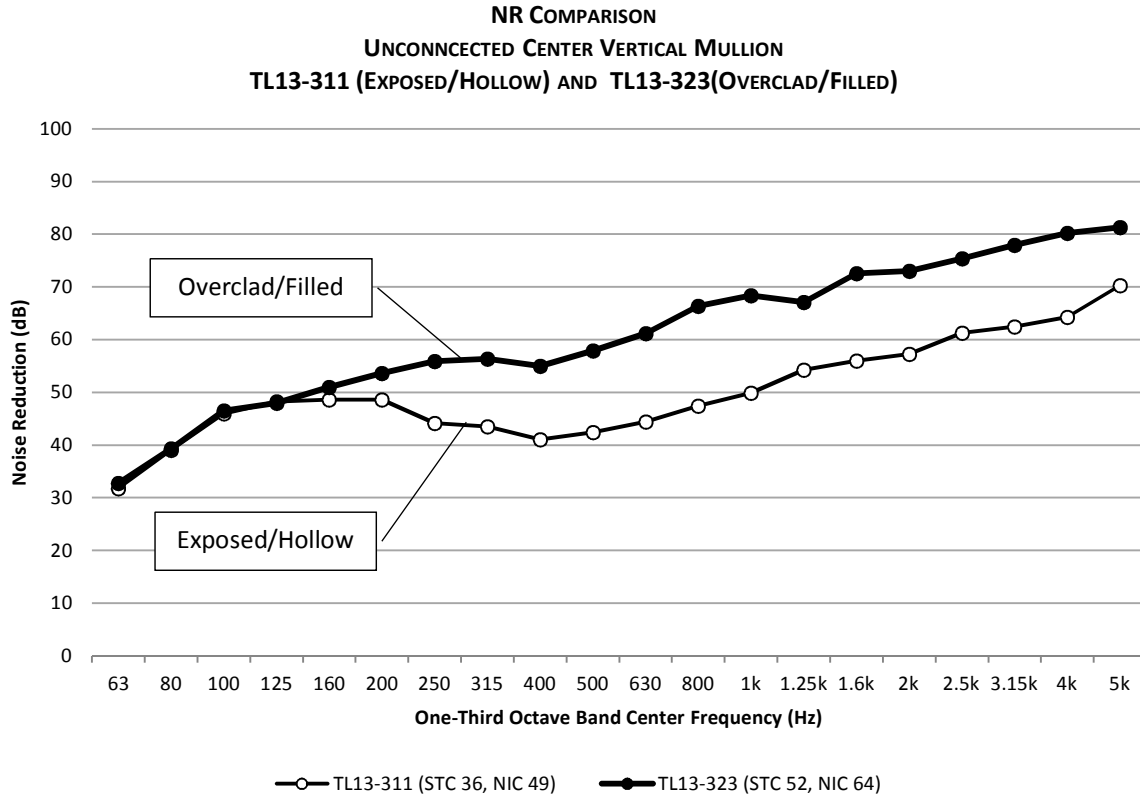

FIGURE 5-11: NOISE REDUCTION SPECTRA BETWEEN TL13-311 AND TL13-323

There is an average 16 dB noise reduction improvement above 250Hz from TL13-311 and TL13-323. A significant difference in noise reduction is expected based on the known mass and damping modifications. The delta in performance occurs across most of the frequency region with the exception at low frequencies.

Similarly, the Noise Reduction graph below compares the connected mullion constants from Phase 3:

- TL14-170: Connected vertical mullion, exposed and hollow
- TL13-168: Connected vertical mullion, filled
- TL14-167: Connected vertical mullion, overlaid and filled

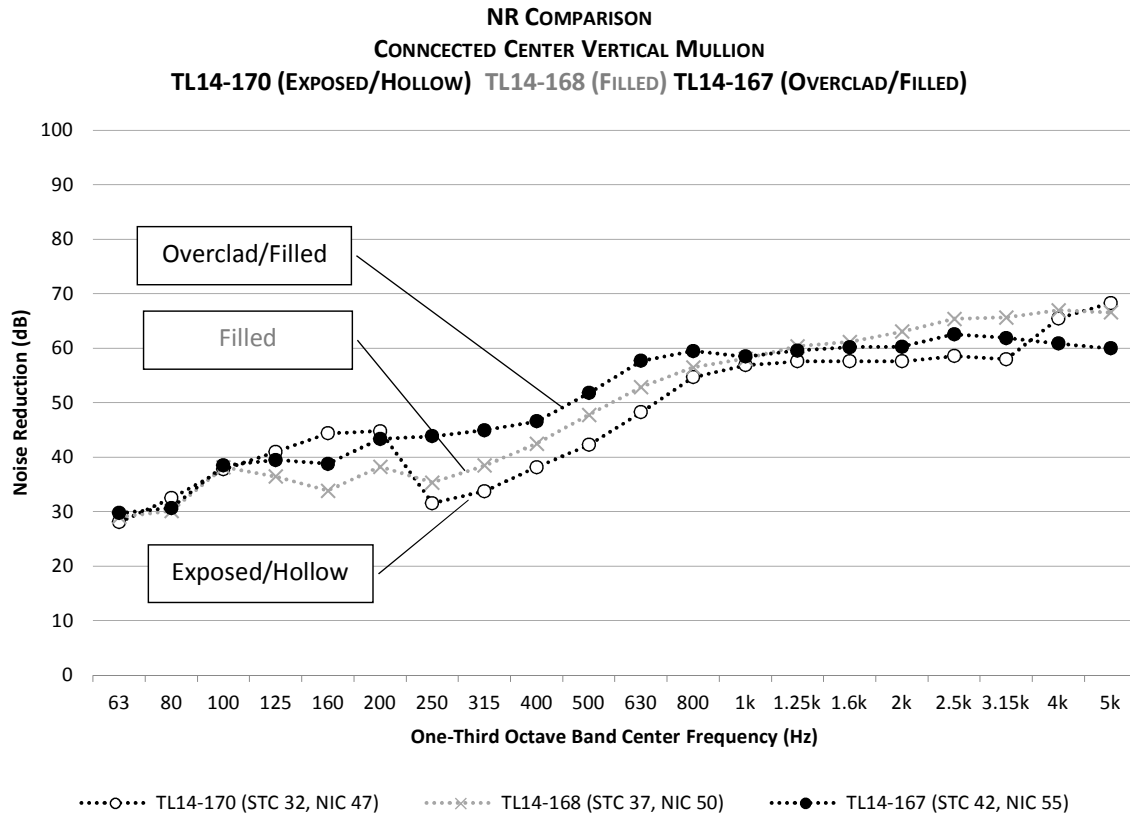

FIGURE 5-12: NOISE REDUCTION SPECTRA BETWEEN TL14-170 AND TL14-167

However the difference between the two curves TL14-167 and TL14-170 in Figure 5-12 is not as significant as those seen in FIGURE 5-11.

It is not clear why there is not a consistent and significant difference throughout the entire frequency range when the mass and damping modification between the two vertical mullion conditions is disparate or why the curves flatten between 1000 Hz to 4000 Hz.

These limitations in improvement and minimal change in the frequency regime strongly indicates that mechanism limiting the sound isolation performance is at the horizontal mullions and glass.

5.2.3.2 VERTICAL MULLION

Although the NR comparison seen in [FIGURE 5-11](#) and [FIGURE 5-12](#) provide an indication of performance limitations, it should be noted that the vertical mullion still has a significant contribution to the sound isolation despite the degradation of flanking at the horizontal mullions and glass. .

As noted in Table 5-1, a 10 dB STC difference exists between lower (TL14-170, STC 32) and higher (TL14-167, STC 42) connected mullions in Phase 3. A 10dB difference is acoustically significant, however based on the horizontal flanking limitations understood from the previous section, it is questioned if the amount of materials used in the TL14-167 test (i.e. overlaid and fill material) has diminishing returns.

Performance observations from Phase 1 and Phase 2B indicate that high performances can be achieved with minimal materials, i.e. *overclad mullions generally outperform filled mullions*. Therefore the center mullion used in TL14-167 may have performed equally as well with less materials, for example, without the infill of MLV pillows.

A balance between materials and performance may be considered with TL13-316 and TL14-168 ([Table 5-3](#)). There is a 1 dB STC difference in performance between the modified mullion without (TL13-316) and with (TL14-168) the glass curtain wall and horizontal mullions. This indicates that the physical modifications made to the unconnected mullion are appropriate to the achievable performance obtained when it is connected to the curtain wall system.

Unconnected Mullion	Connected Mullion	PERFORMANCE DIFFERENCE (STC)
 <p data-bbox="358 1308 472 1388">TL13-316 STC 38</p>	 <p data-bbox="820 1314 932 1394">TL14-168 STC 37</p>	<p data-bbox="1235 1192 1305 1220">- 1 dB</p>

Table 5-3: TL13-316 and TL14-168

An overlaid-only system (without a mullion infill) was not tested during Phase 3. However it may be possible to extrapolate the performance of the system analytically based on the performance of an unconnected overlaid-only mullion ([FIGURE 5-13](#)) and the discrete frequency trends seen in [FIGURE 5-12](#).

This analytical extrapolation may inform if the overlaid-only version of an unconnected mullion has a commensurate lateral sound isolation performance if it were connected to the overall curtain wall system.

The unconnected mullion specimen selected for extrapolation is TL13-325 from Phase 1 Class C2 ([FIGURE 5-13](#)). The specimen assembly consists of the unitized vertical mullion and an overlaid of 5/8" gypsum wall board. The specimen performance obtained in Phase 1 is STC 42.

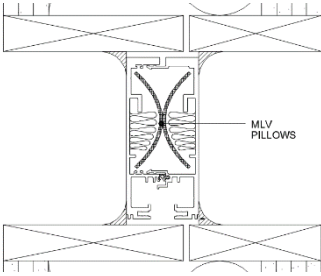
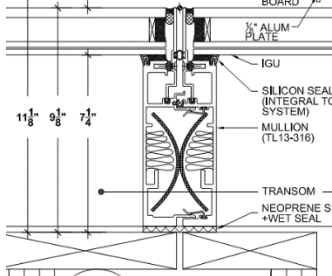
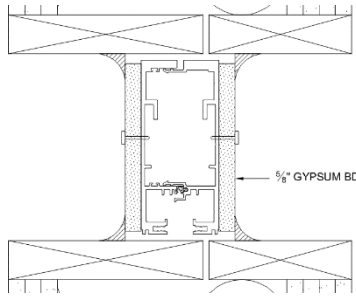

FIGURE 5-13: UNCONNECTED MULLION WITH GYPSUM BOARD OVERCLAD, TL13-325, STC 42 5/8”

The extrapolated adjustments to the TL13-325 TL curve are plotted (FIGURE 5-14). The adjustments and assumptions to create the extrapolated STC 41 curve are described below:

- A. From **63 Hz to 160 Hz** the TL from TL14-168 was directly applied.
In this frequency range the performance between TL13-325 and TL13-316 are almost identical. Therefore the TL values from TL14-168 were used based on the assumption that TL13-325 will behave similar to TL13-316 if it were connected to the curtain wall.
- B. From **200 Hz – 800 Hz** the TL from TL14-168 was increased by the TL difference between TL13-325 and TL13-316.
In this frequency range the TL13-325 measurement has a higher Transmission Loss than the TL13-316 between 200 Hz and 800 Hz. Therefore the TL extrapolation applied the difference between these two spectra and adds it to the performance of TL14-168.
- C. From **1000 Hz – 5000 Hz** the TL from TL14-167 was increased based on an average between TL14-167 and TL14-168.
All phase 3 tests had limited transmission loss performances in this frequency range. The Phase 3 test TL14-167 with the heavy mullion performed lower than the Phase 3 test TL14-168, with a filled cavity (no overclad). Therefore the TL extrapolation used was the median between the two curves.

Unitized Mullion Description	Unconnected Mullion	Connected Mullion	PERFORMANCE DIFFERENCE (STC)
(Overclad/Filled Mullion)	TL13-323 STC 52	TL14-167 STC 42	- 10 dB
(Overclad Mullion)	TL13-325 STC 42	(Extrapolated) STC 41	(Extrapolated) - 1 dB

TABLE 5-4: SUMMARY OF STC EXTRAPOLATION BETWEEN UNCONNECTED AND CONNECTED MULLIONS

The extrapolated transmission loss of TL13-325 is predicted at STC 41, if it were connected to the curtain wall (FIGURE 5-14).

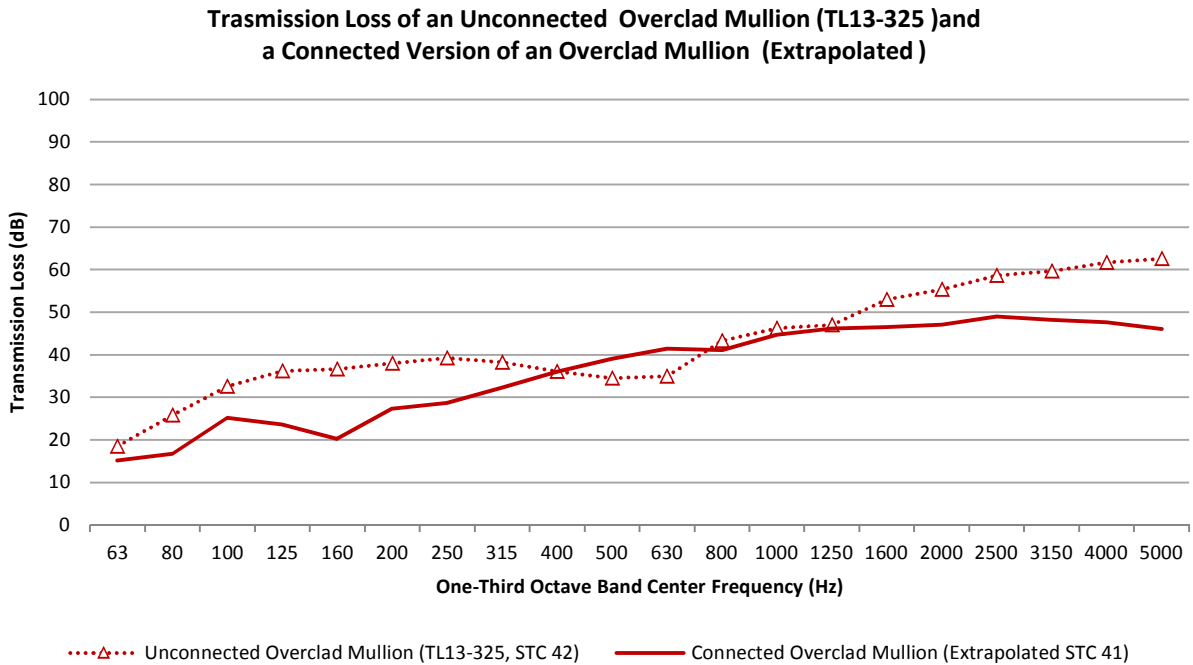

FIGURE 5-14: TRANSMISSION LOSS EXTRAPOLATION OF TL13-325 IF TESTED WITH THE CURTAIN WALL SYSTEM

5.3 COMPOSITE TRANSMISSION LOSS PREDICTIONS

This section uses the UVM (Unitized Vertical Mullion) test results in composite sound isolation predictions with an internal wall partitions. This analysis will evaluate where diminishing returns occur between material construction and acoustic performance. Additionally, the analysis will inform how the mullion influences the overall STC rating. The composite transmission loss predictions apply TL results from UVM Phases 1, 2B, and 3.

Two primary prediction combinations were conducted with the area of a high performing wall and area of a UVM element:

1. Low STC performing UVM element with a high performing demising wall
2. High STC performing UVM elements with a high performing demising wall

The composite STC from these combinations will indicate the dB reduction that may be expected when a curtain wall element is attached to a robust demising partition.

5.3.1 CALCULATION VARIABLES AND DESCRIPTIONS

Figure 5-15 diagrams the location of elements used in the composite calculations with respective surface areas. Composite calculations assume the surface area in elevation facing the wall. The greatest surface area is the demising wall, and each of the curtain wall elements is significantly smaller.

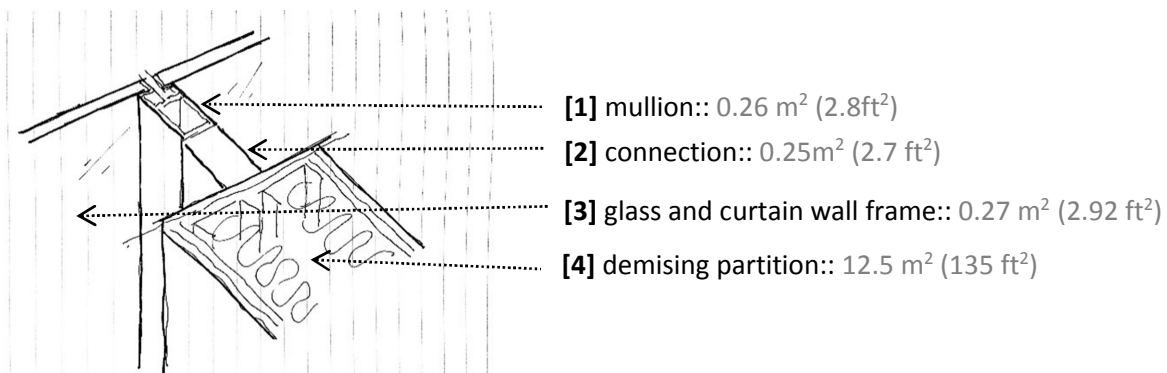

FIGURE 5-15: IDENTIFICATION OF ELEMENTS USED FOR THE COMPOSITE CALCULATIONS AND ASSOCIATED SURFACE AREAS

[1] Mullion

The TL performance used for the mullion element is taken from the Phase 1 testing specimens MC1 (TL13-311) and MC2 (TL13-323). The surface area assumed for the face of the vertical extrusion is 0.26 m² (2.8ft²).

[1] MULLION: PH1-MC1

Low Performing

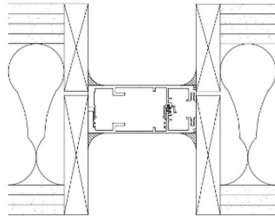

FIGURE 5-16: TL13-311, STC 36

[1] MULLION: PH1-MC2

High Performing

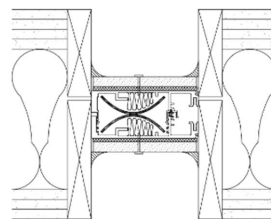

FIGURE 5-17: TL13-323, STC 52

[2] Connection

Two connection elements were selected from Phase 2B, TL13-621 STC 37 and TL13-622 STC 51. These specimens were selected because they are comparable in performance to mullions MC1 and MC2 respectively.

The face area of the connection elements is 0.25 m² (2.7 ft²).

[2] CONNECTION: PH2B

Low Performing

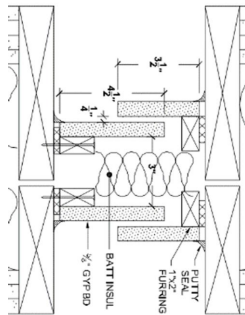

FIGURE 5-18: TL13-621, STC 37, STAGGERED PLATE WITHOUT SEALS

[2] CONNECTION: PH2B

High Performing

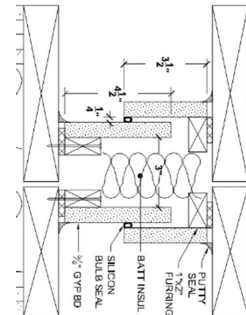

FIGURE 5-19: TL13-622, STC 51, STAGGERED PLATE WITHOUT SEALS

[3] Glass

The glass element is a construction composite of curtain wall glazing and the aluminum perimeter mullion frame. The transmission loss performances used in the composite calculations are taken from the Phase 3 testing, specifically TL14-167 and TL14-170. These represent the highest and lowest performances in

Phase 3. Mullions from Phase 1 are not combined with Phase 3 tests to predict a composite transmission loss.

The surface area assumed is 0.3 m^2 (2.92 ft^2) including the mullion face area and thickness of the glass.

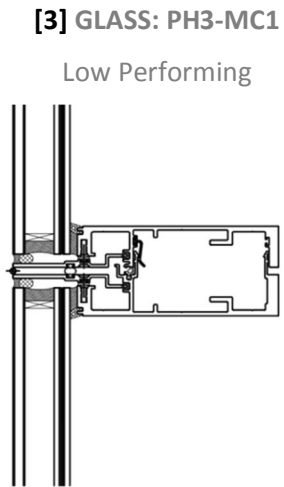

FIGURE 5-20: TL14-170, STC 37 PLAN DRAWING OF UVM HOLLOW AND EXPOSED

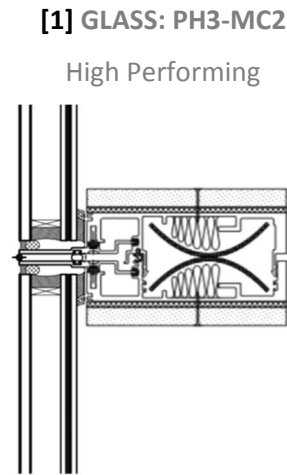

FIGURE 5-21: TL14-167, STC 42 PLAN DRAWING OF UVM FILLED AND OVERCLAD

[4] Partition

The performance of the demising partition is taken from the laboratory tests at the NRC Institute for Research in Construction in Canada⁶⁹, TL93-302 (STC 64). This is considered a high performing wall. The wall face area assumed is 12.5 m^2 (135 ft^2). The wall assembly consists of two layers of 16mm ($5/8''$) gypsum board at either side of a double row of steel studs each 65mm ($2-1/2''$) wide, two layers of batt insulation in the air cavity, and 16mm clearance between studs.

⁶⁹ Ibid.

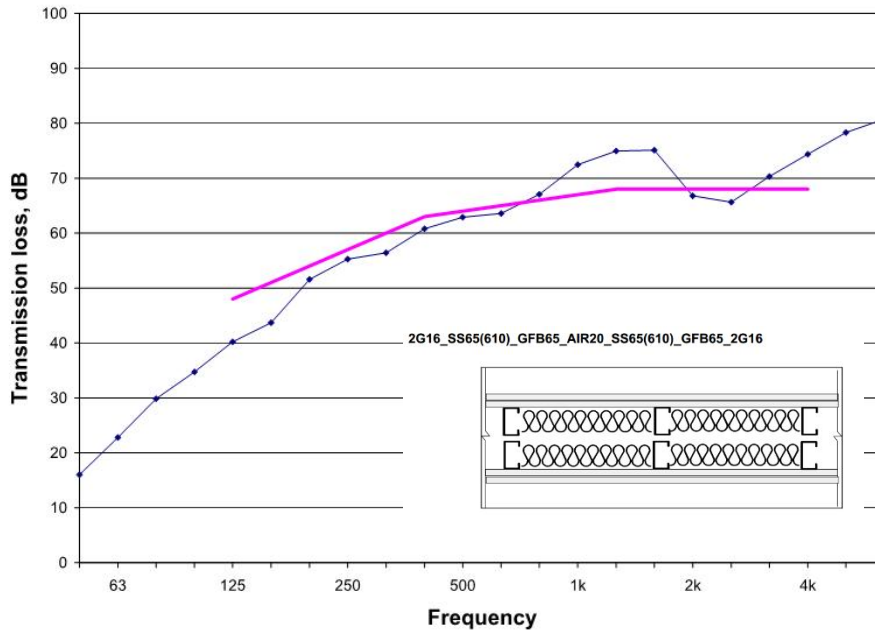
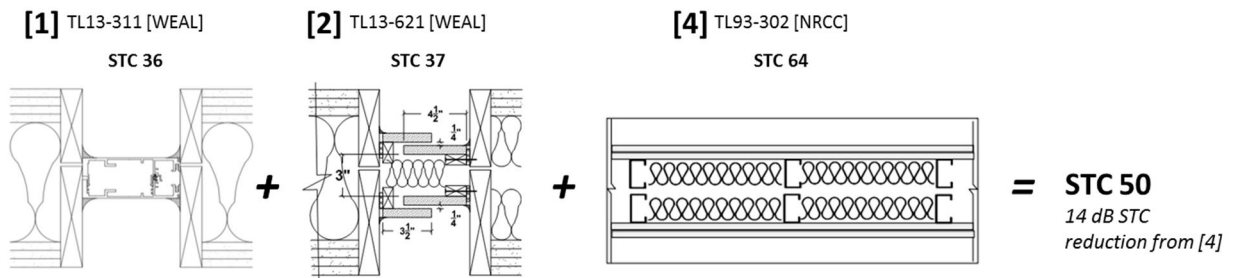

FIGURE 5-22: NRC-CNRC LABORATORY TEST TL-93-302 PERFORMANCE IN OCTAVE BAND CENTER FREQUENCIES

5.3.2 COMPOSITE TL WITH LOW PERFORMING UVM ELEMENTS (WITHOUT GLASS)

The composite transmission Loss for item 2 in Table 5-5, where low performing curtain wall elements are applied to the high performing wall is described (Figure 5-23). No curtain wall glass or frame is included with this prediction.



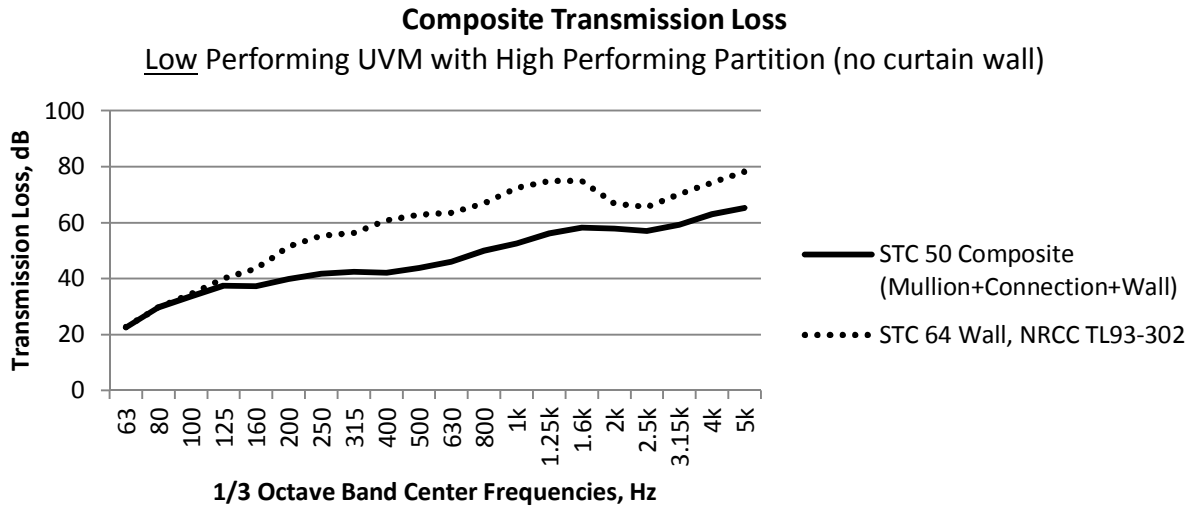

FIGURE 5-23: COMPOSITE PREDICTION OF A **LOW** PERFORMING CURTAIN WALL JUNCTION

These results indicate the ineffectiveness of attempting to terminate a double stud partition, common in residential design into a common vertical mullion with no overclad or fill.

5.3.3 COMPOSITE TL WITH LOW PERFORMING UVM ELEMENTS (WITH GLASS)

The composite transmission loss for item 4 in Table 5-5, where the low performing curtain wall system (including the glass) is applied to the high performing wall (Figure 5-24).

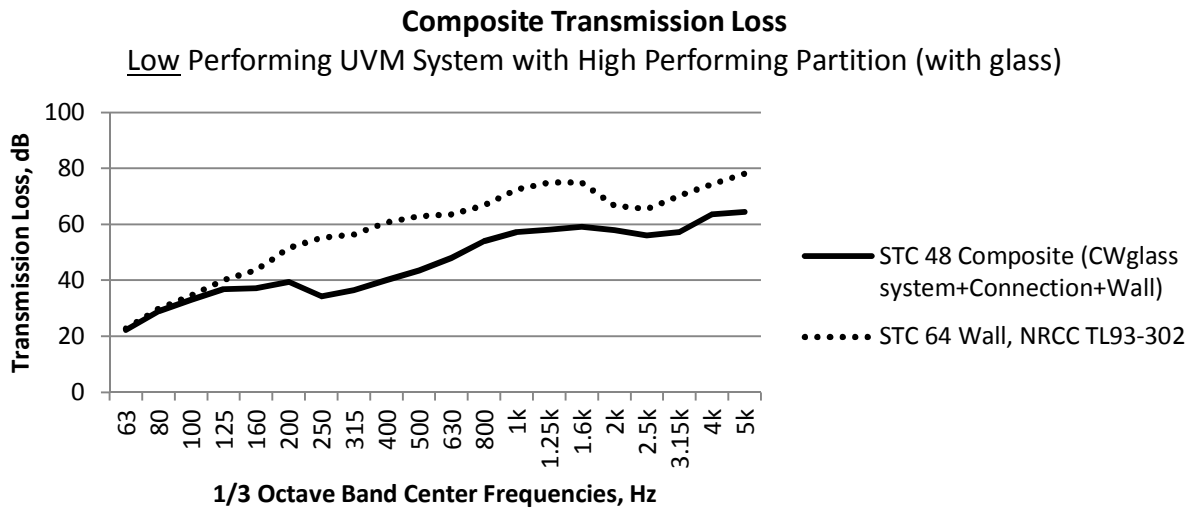
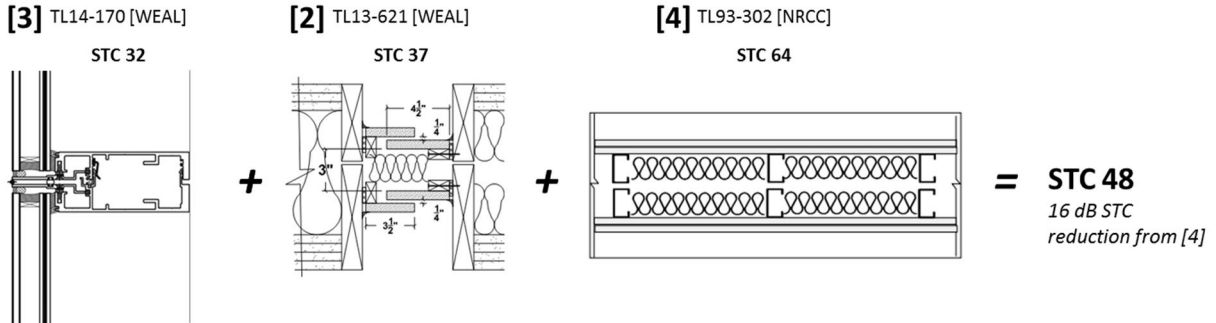

FIGURE 5-24: COMPOSITE PREDICTION OF A **LOW** PERFORMING CURTAIN WALL SYSTEM WITH GLASS

The composite transmission loss performance of the two elements results in STC 48, a 16 dB reduction from the highest achievable partition element.

5.3.4 COMPOSITE TL WITH HIGH PERFORMING UVM ELEMENTS (WITHOUT GLASS)

The composite transmission loss for item 2 in Table 5-6, where high performing curtain wall elements are applied to the high performing wall is described (Figure 5-25). No curtain wall glass or frame is included with this prediction.

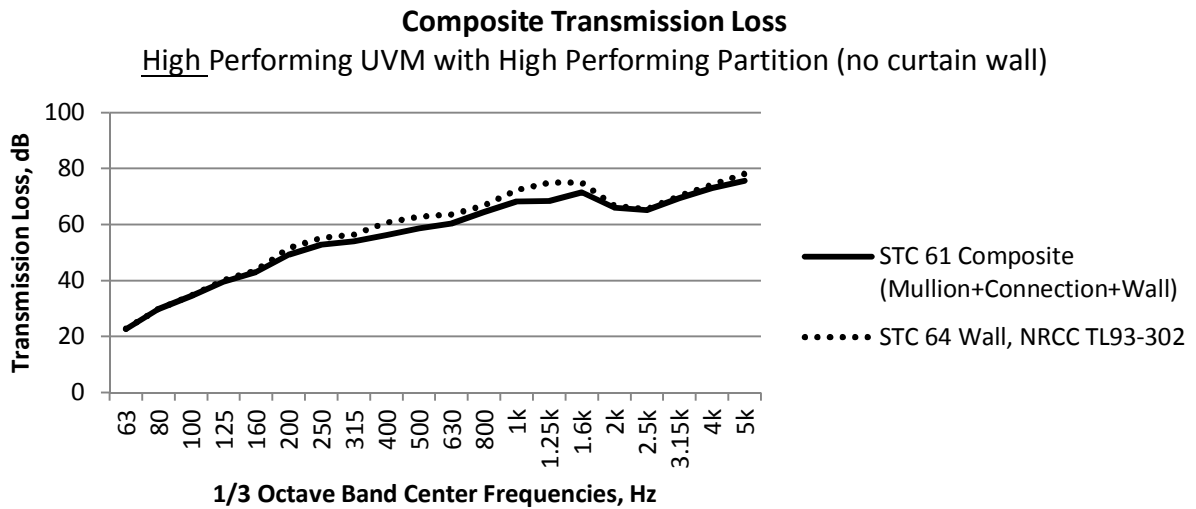
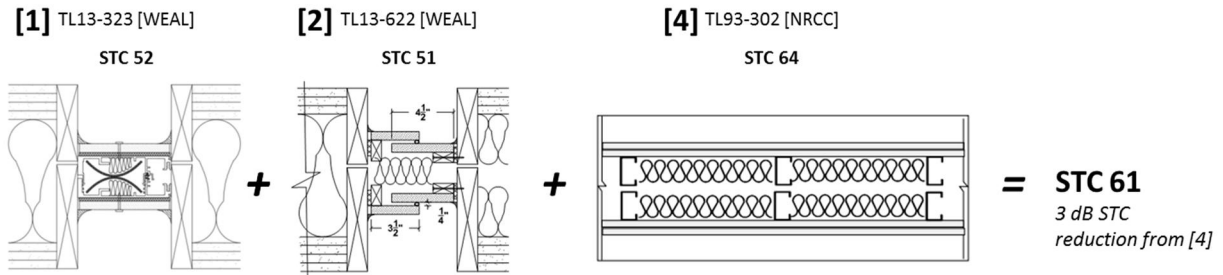

FIGURE 5-25: COMPOSITE PREDICTION OF A **HIGH** PERFORMING CURTAIN WALL JUNCTION

The composite Transmission Loss performance of the three elements results in STC 631, a 3dB reduction from the highest achievable partition element.

There is very little change when the highest achievable elements tested from the UVM method are added to a high performing wall.

In the subsequent composite prediction the influence of the glass and horizontal mullions will be included.

5.3.5 COMPOSITE TL WITH HIGH PERFORMING UVM ELEMENTS (WITH GLASS)

The composite transmission loss for item 4 in Table 5-6, where the high performing curtain wall system (including the glass) is applied to the high performing wall is described (Figure 5-26).

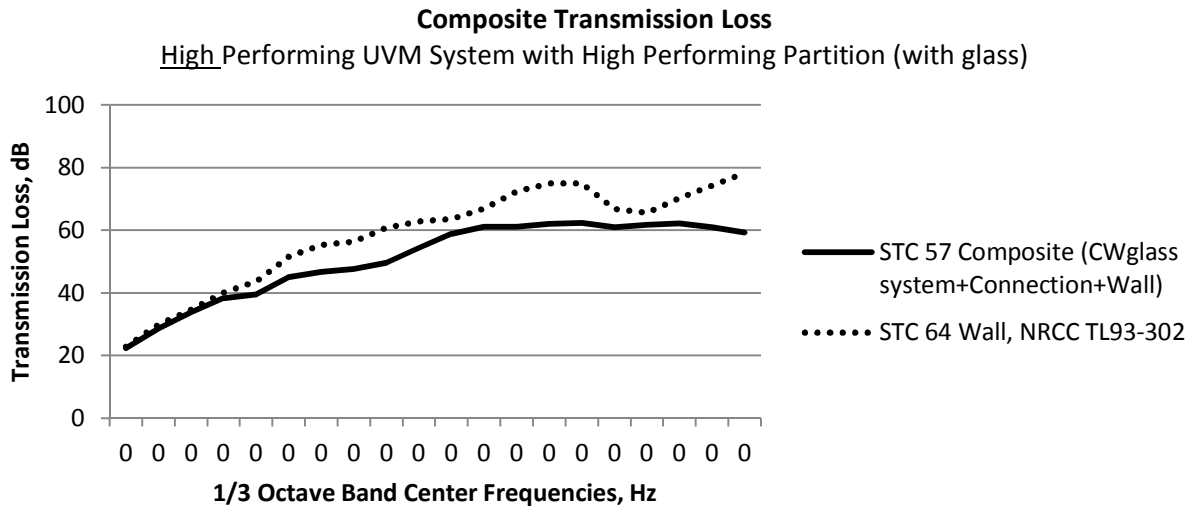
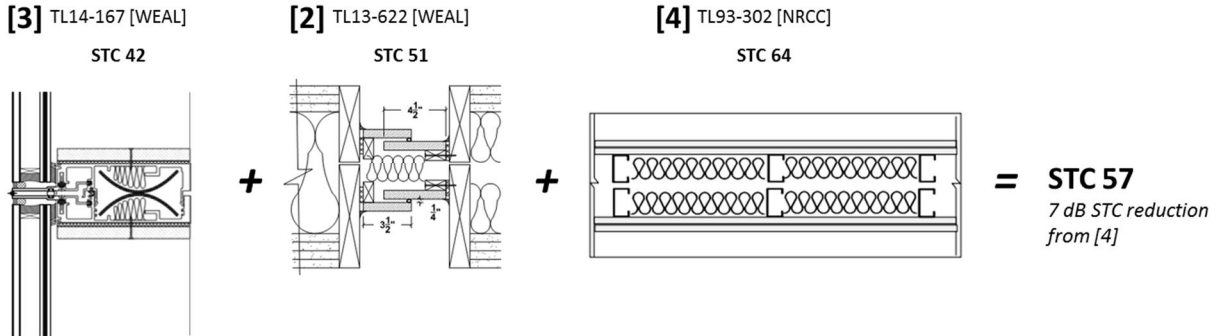

FIGURE 5-26: COMPOSITE PREDICTION OF A **HIGH** PERFORMING CURTAIN WALL SYSTEM WITH GLASS

The composite transmission loss performance of the two elements (i.e. connected mullion [3] and concept connection [2]) with the high performing wall results in STC 57, a 7 dB reduction from the highest achievable partition element.

This indicates value in acoustically modifying the vertical mullion and connection.

5.3.6 SUMMARY OF COMPOSITE TL ANALYSIS

Table 5-5 and Table 5-6 summarize the overall composite STC predictions.

The composite STC reduction compared to the wall STC is identified in the last column of each table.

Low Performing UVM System Summary

LOW PERFORMANCE UVM						
#	[1] MULLION	[2] CONNECTION	[3] GLASS MC1	[4] WALL	COMPOSITE STC	REDUCTION FROM [4]
1	STC 36	--	--	STC 64	STC 53	-11
2	STC 36	STC 37	--	STC 64	STC 50	-14
3	--	--	STC 32	STC 64	STC 49	-15
4	--	STC 37	STC 32	STC 64	STC 48	-16

TABLE 5-5: SUMMARY OF PREDICTED COMPOSITE TRANSMISSION LOSS

There is a 2dB difference between the composite STC of low performing UVM elements and a high performing wall, with or without glass, i.e. STC 50 and STC 48. This is not considered a significant change, and therefore the curtain wall glazing has less of an impact on poor performing curtain wall elements.

The composite STC results are 11dB to 16dB points less than the STC performance of a high performing demising wall. This indicates significant privacy reductions when attaching a lightweight curtain wall system to a heavy partition.

High Performing UVM System Summary

HIGH PERFORMANCE UVM						
#	[1] MULLION	[2] CONNECTION	[3] GLASS MC1	[4] WALL	COMPOSITE STC	REDUCTION FROM [4]
1	STC 52	--	--	STC 64	STC 62	-2
2	STC 52	STC 51	--	STC 64	STC 61	-3
3	--	--	STC 42	STC 64	STC 57	-7
4	--	STC 51	STC 42	STC 64	STC 57	-7

TABLE 5-6: SUMMARY OF PREDICTED COMPOSITE TRANSMISSION LOSS

There is a 4dB difference between the composite STC of high performing UVM elements and a high performing wall, with or without glass, i.e. STC 61 and STC 57. This is a significant change and therefore the curtain wall glazing has more of an impact on high performing curtain wall elements.

The composite STC results are 2dB to 7dB STC points less than the STC performance of a high performing demising wall. This indicates that despite the significant modifications to the curtain wall system, sound flanking paths possibly at the sill and transom reduce the sound isolation performance.

When applying the curtain wall performances to a composite, the achievable TL or NR between adjacent spaces will be limited by the glass infill and horizontal mullions.

5.4 RANKING RELATIVE PERFORMANCE

Many modifications to test elements during the UVM test phases revealed relative changes in sound isolation performance that can be taken from the laboratory and applied in practice.

- **In Phase 1**, significant building modifications were made to the exposed face and internal cavity of the unconnected vertical mullion.
- **In Phase 2**, acoustic concept connections between a mullion and interior demising wall were designed to represent possible façade deflection and seal conditions in practice. Various mass and damping materials were used to create acoustically sealed and unsealed test specimens.
- **In Phase 3**, modifications were strictly applied to the center vertical mullion.

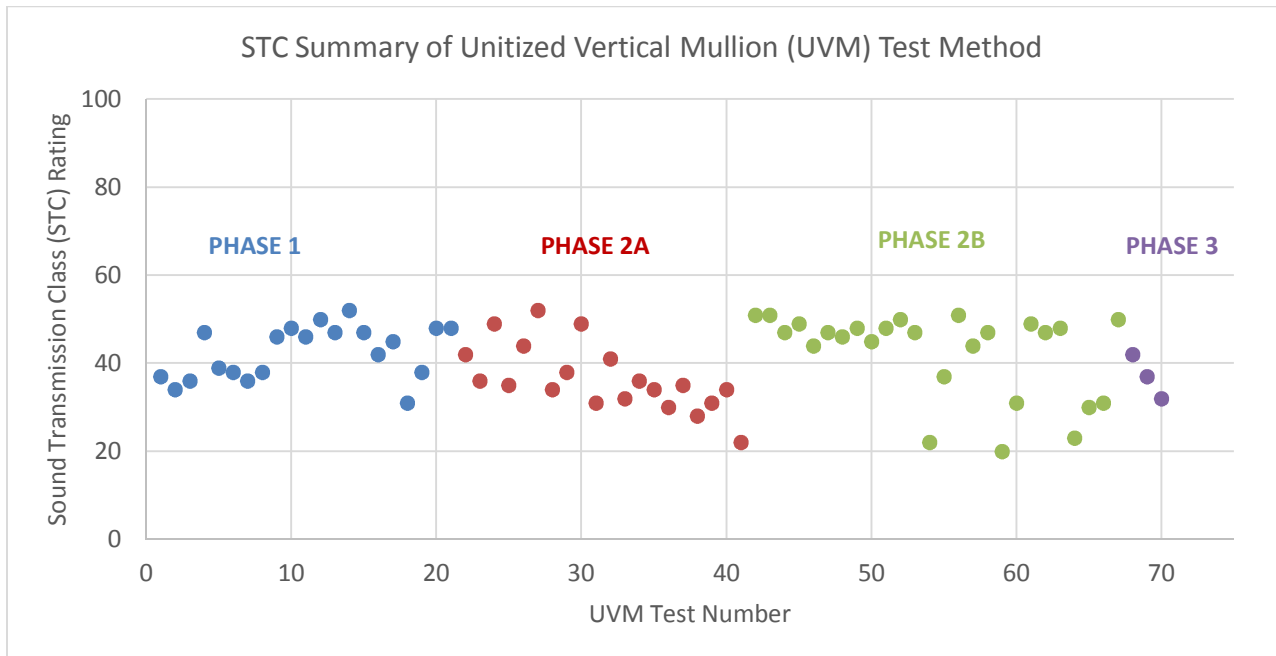

FIGURE 5-27: STC SUMMARY ACROSS ALL LABORATORY TESTS

The table below provides initial thoughts for future development to rank indicative mullion modifications relative to a baseline. The work may be further developed to create a foundation to characterize and further analyze physical variables associated with the mullion design and construction.

PHASE 1	UVM Test No.	WEAL TL No.	STC	Delta from Baseline	Reference Baseline	Description	
	1	TL13-309	37		1	TL13-311	Unconnected Mullions
	2	TL13-310	34		-2	TL13-311	Unconnected Mullions
Baseline	3	TL13-311	36		0	TL13-311	Unconnected Mullions
	4	TL13-312	47		11	TL13-311	Unconnected Mullions
	5	TL13-313	39		3	TL13-311	Unconnected Mullions
	6	TL13-314	38		2	TL13-311	Unconnected Mullions
	7	TL13-315	36		0	TL13-311	Unconnected Mullions
	8	TL13-316	38		2	TL13-311	Unconnected Mullions
	9	TL13-317	46		10	TL13-311	Unconnected Mullions
	10/11	TL13-318/319	48		12	TL13-311	Unconnected Mullions
	12	TL13-320	46		10	TL13-311	Unconnected Mullions
	13	TL13-321	50		14	TL13-311	Unconnected Mullions
	14	TL13-322	47		11	TL13-311	Unconnected Mullions
	15	TL13-323	52		16	TL13-311	Unconnected Mullions
	16	TL13-324	47		11	TL13-311	Unconnected Mullions
	17	TL13-325	42		6	TL13-311	Unconnected Mullions
	18	TL13-326	45		9	TL13-311	Unconnected Mullions
	19	TL13-327	31		-5	TL13-311	Unconnected Mullions
	20	TL13-328	38		2	TL13-311	Unconnected Mullions
	21	TL13-329	48		12	TL13-311	Unconnected Mullions
	22	TL13-330	48		12	TL13-311	Unconnected Mullions
PHASE 2A	UVM Test No.	WEAL TL No.	STC	Delta from Baseline	Reference Baseline	Description	
Baseline	15	TL13-323	52		0	TL13-323	Phase 1 MC-2
	34	TL13-412	31		-21	TL13-323	Mullion+Partition Connection
	35	TL13-413	41		-11	TL13-323	Mullion+Partition Connection
	36	TL13-414	32		-20	TL13-323	Mullion+Partition Connection
	37	TL13-415	36		-16	TL13-323	Mullion+Partition Connection
	38	TL13-416	34		-18	TL13-323	Mullion+Partition Connection
Baseline	3	TL13-311	36		0	TL13-311	Phase 1 MC-1
	39	TL13-417	30		-6	TL13-311	Mullion+Partition Connection
	40	TL13-418	35		-1	TL13-311	Mullion+Partition Connection
	41	TL13-419	28		-8	TL13-311	Mullion+Partition Connection
	42	TL13-420	31		-5	TL13-311	Mullion+Partition Connection
	43	TL13-421	34		-2	TL13-311	Mullion+Partition Connection
	44	TL13-422	22		-14	TL13-311	Mullion+Partition Connection

PHASE 2B	UVM Test No.	WEAL TL No.	STC	Delta from Baseline	Reference Baseline	Description
Baseline	53	TL13-612	44	0	TL13-612	Parallel plates
	54	TL13-613	47	3	TL13-612	Parallel plates
	55	TL13-614	46	2	TL13-612	Parallel plates
	56	TL13-615	48	4	TL13-612	Parallel plates
	57	TL13-616	45	1	TL13-612	Parallel plates
	58	TL13-617	48	4	TL13-612	Parallel plates
	59	TL13-618	50	6	TL13-612	Parallel plates
	60	TL13-619	47	3	TL13-612	Parallel plates
Baseline	61	TL13-620	22	0	TL13-620	Gyp Staggered plates
	62	TL13-621	37	15	TL13-620	Gyp Staggered plates
	63	TL13-622	51	29	TL13-620	Gyp Staggered plates
	64	TL13-623	44	22	TL13-620	Gyp Staggered plates
	65	TL13-624	47	25	TL13-620	Gyp Staggered plates
Baseline	66	TL13-625	20	0	TL13-625	Alum. Staggered plates
	67	TL13-626	31	11	TL13-625	Alum. Staggered plates
	68	TL13-627	49	29	TL13-625	Alum. Staggered plates
	69	TL13-628	47	27	TL13-625	Alum. Staggered plates
	70	TL13-629	48	28	TL13-625	Alum. Staggered plates
PHASE 2B	UVM Test No.	WEAL TL No.	STC	Delta from Baseline	Reference Baseline	Description
	74	TL14-167	42	-10	TL13-323	Connected Mullions
	75	TL14-168	37	-1	TL13-316	Connected Mullions
	77	TL14-170	32	-4	TL13-311	Connected Mullions

FIGURE 5-28: PRELIMINARY RANKING OF UVM TEST ELEMENTS

5.5 ANALYSIS SUMMARY

Comparisons between Phases

Direct comparisons of tests between phases 1 and 2 show that

- At the low frequency region, generally below 250 Hz, the curtain wall has a greater performance degradation than the unconnected vertical mullion due to the sound energy vibrating the glass and horizontal mullions that transfers to the receiving room.
- The vertical mullion is not the weak point (see 3 graphs) with connected mullion conditions. Based on the observed trends and frequency correlations, there is an indication that the glass infill and horizontal mullions are the weak links.

Composite Transmission Loss Predictions

When applying the curtain wall performances to a composite, the achievable TL or NR between adjacent spaces will be limited by the glass infill and horizontal mullions.

The connection elements from Phase 2b do not control the sound performance rating. These connection elements can be controlled and tuned to perform as well as the mullion.

Objectives of the Hypothesis

Sound transmission loss testing of individual and composite architectural elements comprised of and associated with the intersection of the unitized vertical mullion reveals sound flanking path mechanisms controlling the overall sound isolation performance.

This work was designed to reveal the sound flanking path mechanisms controlling the overall sound isolation performance; this objective has been satisfied by this analysis. The glass infill and horizontal mullions have impacted specific regions of the frequency regime of different UVM test specimens and therefore reduce the overall performance of the sound isolation rating.

Sound paths at the glass and horizontal mullions at the source room transmit sound energy into the connected mullion and this subsequently transfers to the receiving room.

This generates an interesting future study to overclad the horizontal mullions and dampen the glazing at the source room for a laboratory measurement test. Enclosing the horizontal mullions and glazing would limit the acoustic energy incident on the specimen to the mullion. Reradiated energy contributions from the glass and horizontal mullions would be limited at the receiving chamber. Therefore the amount of residual energy in the receiving room would primarily be a result of the exposed vertical mullion contribution.

CHAPTER 6 CONCLUSION

HYPOTHESIS:

Sound transmission loss testing of individual and composite architectural elements comprised of and associated with the intersection of the unitized vertical mullion reveals sound flanking path mechanisms controlling the overall sound isolation performance.

6.1 INTRODUCTION

The lateral transmission loss performance of connected and unconnected curtain wall mullions was investigated through acoustic laboratory tests called the Unitized Vertical Mullion (UVM) test method. The impetus for this investigation relates to sound flanking transmission at glass curtain wall façade systems that currently influence construction and design building practices.

Lateral sound flanking paths occurring at the curtain wall system and partition interconnections were identified and the sound isolation reduction at high STC rated demising partitions was investigated. The composite architectural components of the curtain wall façade work dynamically together to influence the lateral sound isolation performance between adjacencies, although certain elements of the composite may transfer sound paths more efficiently than others. The research investigation aimed to understand the independent performance of select curtain wall elements associated with defined sound paths and identify architectural mechanisms influencing the overall sound isolation performance.

Four unique laboratory test phases were conducted to measure the lateral sound transmission at the vertical mullion and associated architectural components. The research objectives were designed to support the sound flanking investigation and construction mechanisms controlling the overall sound isolation performance between spaces sharing a common mullion. Conclusions for each of the following research objective are defined in this chapter:

1. Identify curtain wall mullion practices and procedures.
2. Develop a test experiment designed to measure the unitized vertical mullion and associated components.
3. Identify controlling sound paths at the unitized vertical mullion from the measurement results.
4. Apply the measurement results to predictive composite transmission loss calculations and determine impacts between the vertical mullion and interconnecting walls.

Methods to support the research objectives led to the following final conclusions:

- It was possible to remove the influence of a demising partition to isolate the dominant horizontal sound transmission path of the test elements. The test method revealed the sound isolation performance of individual (flanking) elements.

- Some design solutions were substantially more effective to improve sound isolation performance, e.g. overcladding mullions versus filling mullion cavities.
- The primary acoustic mechanism of energy transfer is the vibrational excitation of the horizontal mullion and glazing by the common unitized vertical mullion. The interaction of these two elements is important and will be the subject of additional and future work. The dynamics of the glass and mullion are coupled; sound incident on the glass displaces as a membrane which applies bending at the boundary condition (mullion) and excites the membrane at the opposite side.
- The test measurements and data show that the curtain wall glazing and horizontal mullions are the controlling the sound paths as demonstrated through the analysis. The glass is a dominant source due to the larger radiating surface area at the receiving room.
- The one-third octave band sound transmission analysis indicated that the lateral sound paths (i.e. at the glazing and horizontal mullions) limit the overall sound flanking isolation of the curtain wall system at specific frequency regions.
- The composite TL analysis indicated significant value in modifying the unitized vertical mullion, although the overall performance is limited by the glazing and horizontal mullions. This indicates that the vertical mullion is a mechanism which highly controls the passage of airborne sound transmission across the curtain wall system and can significantly influence the sound isolation rating.

Details of these conclusions are described in the following sections of this chapter.

6.2 PRACTICES AND PROCEDURES

The first objective investigated various areas relevant to sound flanking transmission in research and practice: global test methods, design and manufactured methods, and precedent investigations and case studies.

Conclusions from the background research reveals that the laboratory and field test methodologies are limited with regards to identifying dominating paths for sound flanking transmission. Laboratory testing procedures for sound flanking transmission is not common in the US. The ASTM E90 procedure for obtaining a STC performance accounts for the overall sound radiating surface area of a building element which includes acoustic mechanisms influencing sound flanking transmission. Similarly field performance ratings (NIC or FSTC) for sound isolation in accordance with ASTM E336 accounts for the radiating surfaces including the composite performance of an interconnecting wall. Since most of the measurement conditions include composite elements such as wall partitions, this also limits how to approach the improvement for the curtain wall design.

Manufacturer solutions are generally limited to product resolutions at the vertical mullion. They do not take into account other defined sound paths at the curtain wall system, such as at the partitions connections, glass, and horizontal mullion.

Precedent case studies of laboratory or field measurements on curtain walls are typically conducted as composites with the exception of the LA LIVE⁷⁰ case study project by Enclos Corp. The Unitized Vertical Mullion (UVM) testing methodology expands upon the Enclos precedent to support the second objective of this research study.

6.3 TEST METHODOLOGY FOR UNITIZED MULLIONS

The second objective was achieved by designing a laboratory test procedure (Unitized Vertical Mullion - UVM method). This method was developed to first measure the TL of individual components (vertical mullion and connectors) independently and separately from the curtain wall. Measurements were conducted in the absence of a demising wall assembly. The WEAL filler wall is rated STC 74. The high filler wall rating removes the influence of a composite interconnecting wall so that the UVM unconnected and connected elements may be measured independently. The unique test procedure included a consistent and controlled approach to measure the unitized vertical mullion with and without the glazing and horizontal mullion elements.

The results of these tests provide sound transmission loss data for individual mullion modifications, and thus they may be compared to the sound flanking measurement of the curtain wall.

The sound flanking curtain wall measurement included a unique test set up designed specifically to enclose the full size curtain wall bays. This test chamber assembly in Phase 3 was an effective way to target the transmission loss performance in the absence of other sound flanking variables that normally exist in a building.

Overall significant conclusions and contributions based on the experiment design of the UVM test method are listed:

Test Method

- The experiment design is a unique method to measure the individual elements of a curtain wall system.
- The lateral sound flanking transmission loss measurement of a full-scale curtain wall specimen is unprecedented for a two-chamber laboratory that includes the construction of semi-anechoic chambers to enclose the curtain wall bays.
- All test specimens were measured in the absence of a composite wall and perimeter seal and mounting conditions were uniform to develop relative comparisons.

Phase 1 (Unconnected Mullions)

- A broad range of mullion performances (with variations of mass and damping) have been collected for relative comparison:
 - The highest unconnected mullion performance achieved was STC 52.
 - The lowest unconnected mullion performance achieved was STC 36.

⁷⁰ Dehghanyar et al., "Inter-Story Acoustical Evaluation of Unitized Curtain Wall Systems."

- An overclad-only modification at the mullion significantly improves performance over a mullion cavity infill with no overclad.
- Gypsum board overcladding is more effective than aluminum overcladding.

Phase 2a and 2b (Partition Connections)

- The highest performing connection without a mullion was STC 51.
- The highest performing partition connections or seals are comparable to or outperform unconnected mullions. Therefore the intersection between the demising partition and mullion is not necessarily the component controlling the sound isolation performance of the system.
- The acoustic detailing of edge seals (e.g. material and gap size) can significantly influence performance.
- Bead seals and mineral wool fill can significantly influence the transmission loss performance of the connection elements (with no mullion). Sealed air tight conditions without batt infill performed higher than conditions with batt-filled cavities and no bead seals.
- Parallel aluminum plate conditions reveal that the profile of the aluminum mullion extrusion may influence the achievable isolation provided by the mullion even though interstitial leg connections are connected by a resilient gasket.
- The parallel aluminum plate condition performed higher than the hollow and exposed mullion. This indicates that the interstitial leg connections that exists within the mullion profile is influencing the achievable sound isolation.
- Gypsum board connection configurations are more effective than those with aluminum.

Phase 3 (Connected Mullions)

- Sound paths at the curtain wall glazing and the horizontal mullions are significantly impacting the overall sound isolation performance.
- Modifications at the mullion significantly improve performance; however overall performance is limited by the horizontal mullion and glazing.
- The greatest depreciation in performance due to sound flanking at the center vertical mullion was 10dB STC points: STC 52 (unconnected mullion) to STC 42 (connected mullion condition).
 - The highest connected mullion performance achieved STC 42.
 - The highest connected mullion performance achieved STC 32.

The results from the modifications at each test phase provide information on what architectural mechanisms of the curtain wall are controlling the overall sound isolation performance.

An additional value from the test measurement series is its potential application in the profession to improve curtain wall mullions. The test series enables designers to make comparisons between different modifications and not necessarily take the face value performance rating. The various architectural enhancements conducted in the empirical testing reveal relative changes that can be taken from the laboratory and applied in practice to guide designers of relative improvements.

The data collected to satisfy objective 2 of this research study is applied to two different analysis methods to meet objectives 3 and 4.

6.4 CONTROLLING ELEMENTS AT THE UNITIZED VERTICAL MULLION

The method to support the third objective was to evaluate the transmission loss and noise reduction results of the connected and unconnected conditions of the UVM test method. The summary of STC performance ranges for each UVM test phase are listed below:

Phase 1	Unconnected Mullion (without glazing)	STC 36 – STC 52
Phase 2a	Unconnected Mullion + Partition Connection (without glazing)	STC 22 – STC 41
Phase 2b	Partition Connection (without glazing)	STC 25 – STC 51
Phase 3	Connected Mullion (with glazing)	STC 36 – STC 42

The sound transmission loss performance is limited to STC 42 where the unitized mullion is connected to the curtain wall system. It may be concluded that the highest performing elements tested in Phase 1 and Phase 2 are not controlling the overall STC performance in the main curtain wall system because they are capable of achieving such high performances in their respective phases.

Additionally, comparison of the Phase 3 frequency spectra revealed a limit to the transmission loss improvement between 1000 Hz – 3150Hz (FIGURE 6-1).

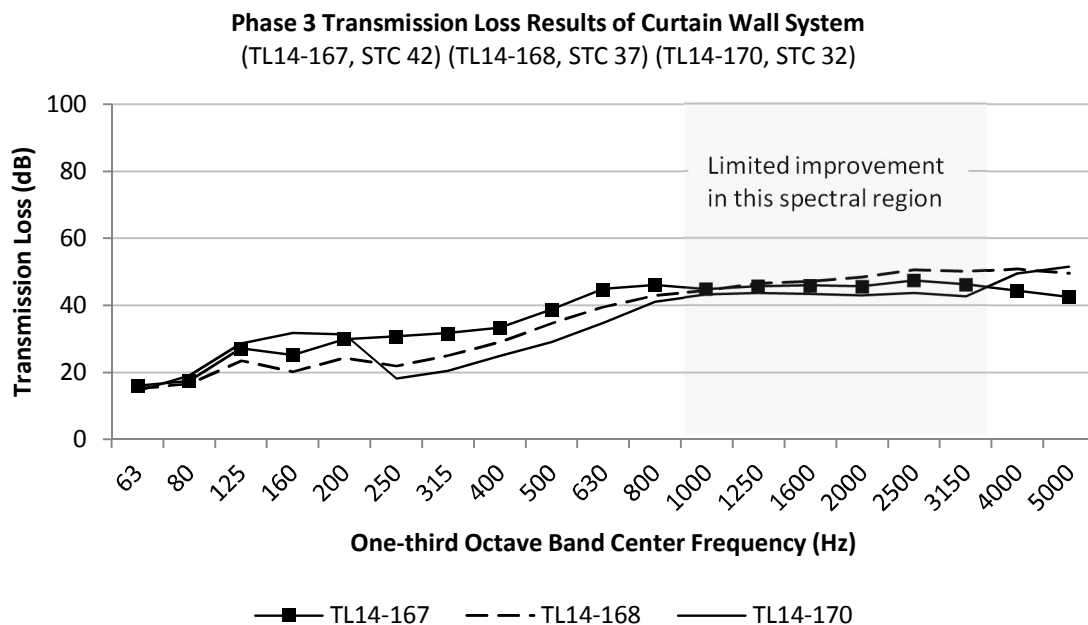
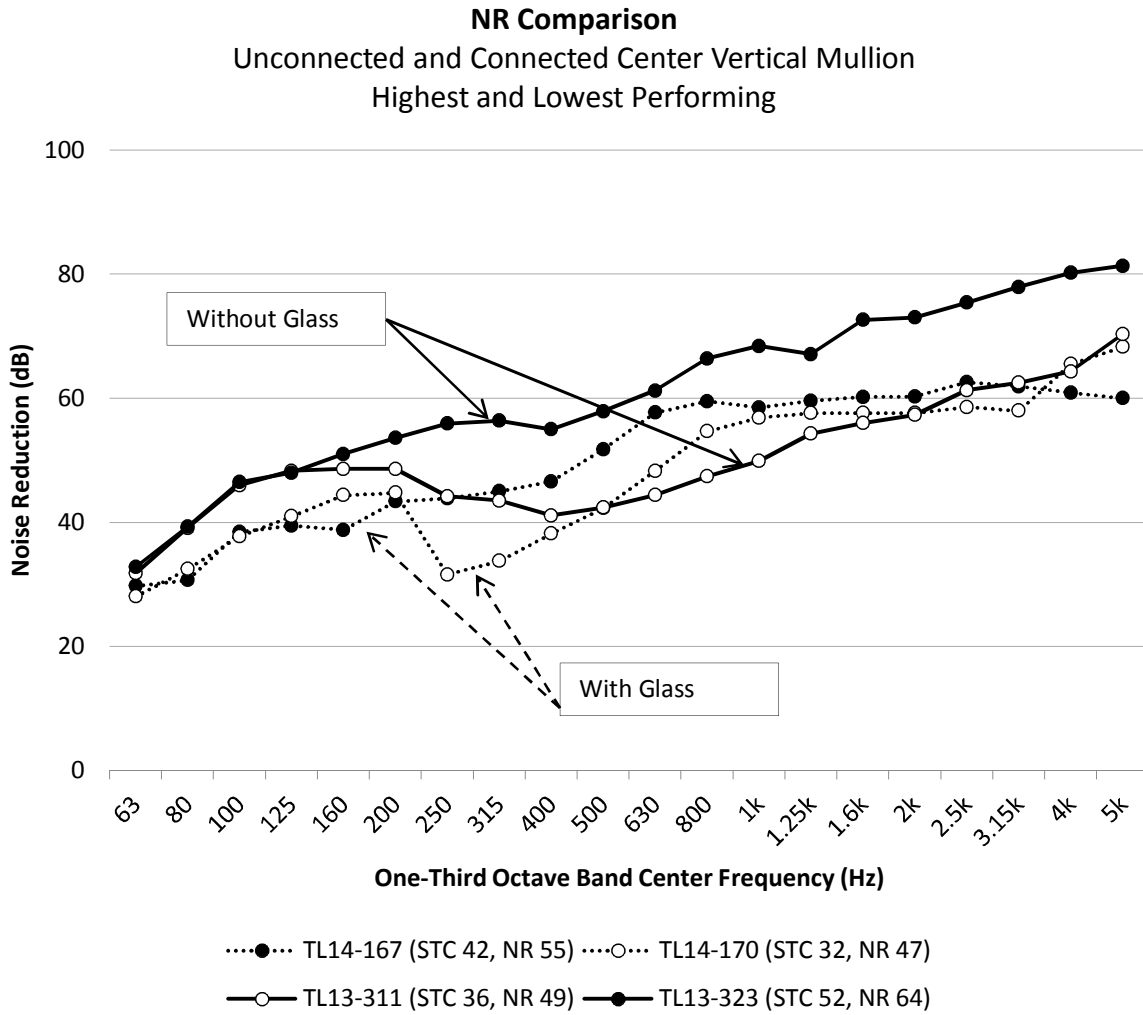

FIGURE 6-1: LIMITED SPECTRUM WITH CURTAIN WALL DESIGN

Based on the comparative analysis of Phase 3, glass infill may not be the only limiting factor, as previously believed. Sound paths created at the horizontal mullion are critical variables influencing the transmission loss.

This opens opportunities for future test experiments to determine performance characteristics of the upper and lower horizontal mullions.

Based on the overlay of noise reduction curves in **FIGURE 6-2** the curtain wall system significantly changed the results of the unconnected mullion tests. Therefore the introduction of the glazing and horizontal mullions have a significant impact. The behavior of some of the frequency regions are not yet explained, and further study on these specific regions is necessary.



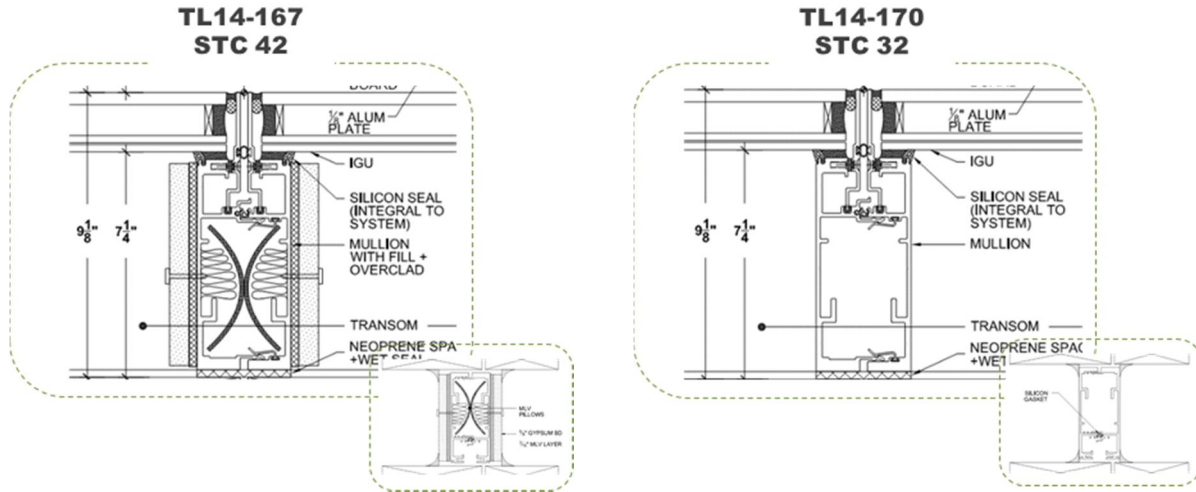

FIGURE 6-2: LIMITED SPECTRUM WITH CURTAIN WALL DESIGN

6.4.1 IMPROVEMENTS AT THE UNCONNECTED UNITIZED MULLION

It was concluded that overlaid design modifications to the vertical mullion perform better than filling the internal air cavity. Relative improvements for the unconnected unitized mullion condition are tabulated (Table 6-1).

MULLION	MULLION DESCRIPTION	STC	RELATIVE STC IMPROVEMENT FROM BASELINE
MC1: (3) TL13-311	Exposed and Hollow, no modification	36	BASELINE
MC1a: (7) TL13-315	Filled with mineral fiber	36	+0
MC1b: (17) TL13-325	Overclad with 5/8" gypsum board	42	+6
MC1c: (10) TL13-318	Overclad with 1/8" Alum + 3/16" MLV	48	+12
MC1d: (13) TL13-321	Overclad with 5/8" gypsum + 3/16" MLV	50	+14

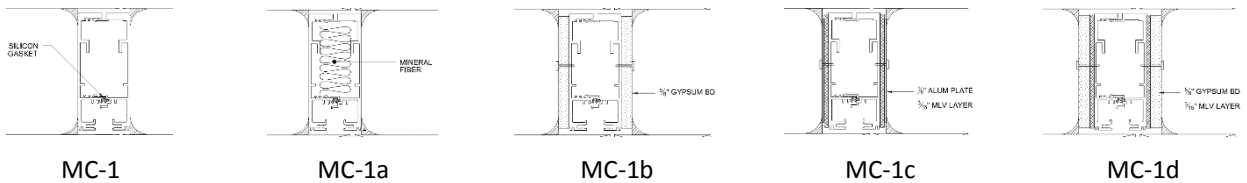

Table 6-1: Relative STC improvements for various mullion retrofit options

6.4.2 IMPROVEMENTS AT THE CONNECTED UNITIZED MULLION

Relative improvements for the connected unitized mullion condition are tabulated (Table 6-2).

MULLION	VERTICAL MULLION DESCRIPTION	STC	RELATIVE STC IMPROVEMENT FROM BASELINE
Typical Curtain wall system (TL14-170)	Exposed and Hollow, no modification	32	BASELINE
Curtain wall system with a filled mullion (TL14-168)	Filled with MLV Pillows (Limp Mass Vinyl/Mineral Fiber)	37	+5
Curtain wall system with a filled and overclad mullion (TL14-167)	Overclad with 5/8" gypsum board + limp mass vinyl plate and filled with MLV Pillows	42	+10

TABLE 6-2: RELATIVE STC IMPROVEMENTS FOR VARIOUS MULLION RETROFIT OPTIONS

6.5 COMPOSITE TRANSMISSION LOSS PERFORMANCE

Methods used to fulfill the fourth objective used the composite TL equation to determine the impact of a demising partition. This objective returns to the issue in architectural acoustics where an acoustically weak link impacts a high performing element when joined as part of a composite system. In this case, the method targets the performances obtained from objective 2 and applied to a demising partition. Table 6-3 provides the summary of impacts when elements from the UVM test method are joined with a high performing demising wall.

UVM PERFORMANCE						
#	MULLION	CONNECTION	CURTAIN WALL (GLASS) ¹	WALL RATING	COMPOSITE RATING	DELTA FROM WALL STC
1	STC 36	STC 37	--	STC 64	STC 50	14 dB
2		STC 37	STC 32	STC 64	STC 48	16 dB
3	STC 52	STC 51		STC 64	STC 61	3 dB
4		STC 51	STC 42	STC 64	STC 57	7 dB

TABLE 6-3: SUMMARY OF PREDICTED COMPOSITE TL PERFORMANCES

¹ Sound flanking present

The composite rating based on the assembly from line #1 and #2 in Table 6-3 shows a 14 dB STC – 16 dB STC point depreciation to the STC 64 partition. This confirms the ineffectiveness of terminating high performing partition into a common vertical mullion with no modification (i.e. overclad or fill).

The composite rating based on the assembly from line #3 and #4 in Table 6-3 shows a 3dB – 7 dB STC point depreciation to the STC 64 partition. This lower range in performance reduction is similar to what is typically measured as an NIC the field and therefore is in line with in situ performance expectations of a high performance partition.

The deltas listed in Table 6-3 are indicative for a high performing interconnecting wall and will be different with a demising partition of a lower performance, ie. STC 50 partition.

A conclusion from the composite TL analysis reveals that there is a benefit to modifying the center vertical mullion, but the overall performance of the system is limited by the sound paths at the glass and horizontal mullions.

6.6 LIMITATIONS

Laboratory tests were conducted during Phase 1 and Phase 2 with an objective to identify the highest performing specimen based on acoustic concept designs used in practice.

More tests were conducted in these specific phases than anticipated since it was achievable to manipulate the scale of the test rig over modest periods of time.

Phase 3 was limited to 3 test configurations. Each of these test rigs in this phase required significant manpower, machinery (e.g. forklift), time, and construction; therefore investigations were limited to rating the highest and lowest performing mullions. Ideally more tests would have been conducted with modifications to the horizontal mullions; however this may be conducted for the future laboratory test investigations to better understand limitations at the glass and vertical mullion.

CHAPTER 7 FUTURE WORK

7.1 FUTURE TESTING AND DESIGN INVESTIGATIONS

Unexpected and esoteric findings from the Unitized Vertical Mullion (UVM) test method have led to ideas for future investigations for sound and vibration test measurements, ideas for mullion design concepts, and further analytical studies on some of the research findings. These are categorized in Table 7-1.

Study 1	Airborne Sound Measurement	Advance the UVM Test Method by modifying the horizontal mullions in addition to the vertical mullion to evaluate the glazing path.
Study 2	Airborne Sound Measurement	Advance the UVM Test method by modifying the inboard glass lite of the IGU assembly to compare the lateral transmission loss of laminated versus monolithic panes.
Study 3	Vibration Measurements	Refine and develop the initial vibration analysis conducted in Appendix D.
Study 4	Intensity Measurements	Conduct intensity measurements to evaluate sound energy at the curtain wall glazing, vertical mullions, and horizontal mullions.
Study 5	Design Concepts	Develop and explore concept designs at the horizontal and vertical mullion (stack joint) to resilient decouple elements.
Study 6	Design Concepts	Develop and explore concept design within the vertical mullion cavity where the interstitial “leg” extrusions connection both sides of the unitized parts.
Study 7	Analytic Study	Further develop analysis of the unexplained transmission loss depreciation of Phase 3 specimens.
Study 8	Analytic Study	Further develop the initial ranking of relative architectural modifications from the UVM test method (Section 5.4).
Study 9	Analytic Study	Study and identify mechanisms contributing to the discrete resonances occurring at overclad mullion specimens and certain gaps at the filler wall aperture.
Study 10	Analytic Study	Determine applications of the UVM test method to predictive analysis in accordance with ISO EN standard definitions.

TABLE 7-1: FUTURE WORK

7.1.1 FUTURE LABORATORY TESTS MEASUREMENTS

Propose future studies #1- through #4 are measurements conducted with the laboratory test rig used in Phase 3 of the UVM test method, including the semi-anechoic chamber enclosures to frame around the curtain wall bays.

One of the primary findings from the UVM Phase 3 indicates that the horizontal mullion and glass are significant sound paths. This was deduced by comparison trends seen in the plotted one-third octave band

frequency regimes that point to influences from the horizontal mullions or glazing. Study #1 would better identify discrete contributions at the glazing by adding mass and damping to the horizontal and vertical mullions. In addition to measuring influences from modifications at the aluminum frame, the glazing should also be dampened or enclosed to isolate the influence of the vertical mullion.

The curtain wall test specimen in the UVM test method included laminate glass pane at the inboard side of the IGU. The laminated pane will influence the flexural vibration transfer across the glass from the source to receiving side. Study #2 would investigate the lateral transmission loss of a curtain wall system with a monolithic insulated glazing unit.

Studies #3 would refine and improve upon the initial measurement study discussed in Appendix D. The initial work infers that the glazing, as opposed to the vertical and horizontal mullion, is the dominating path due its radiating surface area. Repeat measurements at the vertical and horizontal mullions and glazing should be conducted to include an impulsive transfer function.

Study #4 would consider a sound intensity survey at the wall, glass, sill, and mullion to obtain sound intensity levels at curtain wall elements at the receiving chamber. Both the vibration and intensity measurements may provide better indications of the controlling elements.

7.1.2 FUTURE CURTAIN WALL DESIGN CONCEPT STUDIES

Studies #5 and #6 would further explore architectural design concepts at the stack joint and the internal connection extrusions at the mullion. Part of the study will require background research into the global models of curtain wall extrusion and connection typologies.

Significant sound transmission loss reductions occurred during the UVM Phase 3 testing that are believed to be caused by the mechanical connections located at the vertical and horizontal mullion intersection and at the “leg” extrusion that connects each side of a unitized mullion at a gasket. Exploring resilient connection modifications may lead to an improved transmission loss across the façade.

Designs by Schüco are already developing interesting variations to the mullion connections. As an example, the Schüco mullion Type USC 65⁷¹ is designed to connect interstitial leg extrusions and a silicone gasket. This seems to have promising performance characteristics, and it would be interesting to compare this mullion element type with the mullion element used in the UVM tests.

7.1.3 FUTURE RESEARCH ANALYTICAL STUDIES

Unexplained frequency patterns were identified during the Phase 3 test measurement analysis from the influence of the glazing and horizontal mullion elements. Study #7 would further analyze these frequency regimes to determine the mechanisms contributing to discrete resonances and certain responses at low frequencies.

Study #8 proposes to finalize some of the initial studies seen in Chapter 5 and create a matrix that classifies and ranks the percentage improvement in modifying mullion elements so that designers can be informed of the relative difference for sound isolation in practice.

⁷¹ Schüco, “Overview of Profiles for Schüco Facade USC 65.”

Discrete resonances were noted in all phases of the UVM test method. Deductions indicated critical frequencies depended on natural frequency of the materials used or potentially the size of certain test apertures. Study #9 is proposed to evaluate resonances for select specimens to reveal if corrections to the frequency regimes are necessary. For example, a discrete resonance at 630Hz occurred at unconnected mullion specimens with an aluminum tube overlaid (Phase 1 Class C4). The tube consisted of a 6" depth x 1-1/2" width x 60" height and an aluminum thickness of 1/8". These resonant characteristics controlled much of the overall sound transmission performance of the specimen. Therefore if the resonance could be corrected by means of structural stiffening, this would inform resolutions to improve the overall sound isolation performance. Other notable resonances occurred in Phase 2A where an aluminum overlaid was placed over silicone connection elements, and the effect reduced the overall sound transmission loss.

The boundary condition around the test specimens may have also influenced the performance of the unconnected mullion tests. Air slots created on either side of the mullions and the chamber filler wall were generally 1/4" - 1/2" wide x 60-1/2" tall x 3" deep. The influence of these slits and gaps may be analyzed by research and theories developed by Uris et al (2003)⁷² and Gomperts and Kihlman (1967)⁷³.

It is noted that discrete resonances occurred due to the small aperture size. This may be limiting the overall TL of the elements. The future analytical study should include a calculation of the resonance frequency based on the aperture dimensions at each phase. This should be compared to test specimens with common resonance frequencies to see where this may analytically be corrected.

Study #10 would apply the ASTM E90 test measurement data in the UVM test method to standard sound flanking prediction models in accordance with ISO 12354 and ISO 10848 so that normalized sound flanking indices may be identified for broader applications. It would be informative to correlate the indices between ISO and ASTM standards and normalize sound flanking transmission for the UVM test specimen.

7.2 CONCLUSION

The lateral transmission loss performance of connected and unconnected curtain wall mullions was investigated using the Unitized Vertical Mullion (UVM) method. The original research was conducted over approximately 80 acoustic laboratory tests to measure the performance of select curtain wall elements measured independently and then modified to identify the highest practicable STC that may be achieved and relatively compared. Although great progress was made in understanding how critical components are responsible for sound flanking transmission paths, many potential future studies are possible that would add to the field of architectural acoustics. Continuing research will enhance designers understanding of façade tectonic cohesion specific to acoustic design integration and to inform building engineering design and performance decisions.

⁷² Antonio Uris et al., "The Influence of Slits on Sound Transmission through a Lightweight Partition," vol. 65 (Applied Acoustics, Elsevier Ltd., 2003), 421–30.

⁷³ M.C. Gomperts and T. Kihlman, "The Sound Transmission Loss of Circular and Slit-Shaped Apertures in Walls," *Acta Acustica United with Acustica* 18, no. 3 (1967): 144–50.

BIBLIOGRAPHY

2013 California Green Building Standards Code California Code of Regulations, Title 24, Part 11 (CALGreen). International Code Council, ICC, 2013.

Andow, Kei, and Takashi Koga. "Experimental Study on Effect of Lining for Flanking Transmission of Building Facade." In RBA-04 - SOUND INSULATION OF MULTI-FAMILY DWELLINGS, 6. RBA-04 - SOUND INSULATION OF MULTI-FAMILY DWELLINGS. Sevilla, Spain, 2002. <http://www.sea-acustica.es/Sevilla02/rba04002.pdf>.

Antonio, Nick. "Residential Sound Insulation and Building Code." presented at the Acoustic Society of America, LA Chapter Meeting, Los Angeles, January 15, 2008.

Association of Interior Specialists. "Building Acoustics - Terminology." AIS Association of Interior Specialists. Accessed April 6, 2014. <http://www.bre.co.uk/page.jsp?id=1146>.

ASTM E33 Committee. "ASTM E90 - 09 Test Method for Laboratory Measurement of Airborne Sound Transmission Loss of Building Partitions and Elements." ASTM International, 2009. <http://www.astm.org/Standards/E90.htm>.

ASTM E33 Committee.. "ASTM E336 - 11 Standard Test Method for Measurement of Airborne Sound Attenuation between Rooms in Buildings." ASTM International, 2011. <http://www.astm.org/Standards/E336.htm>.

ASTM E33 Committee.. "ASTM E413 -10 Classification for Rating Sound Insulation." ASTM International, 2010. <http://www.astm.org/Standards/E413.htm>.

Barista, Dave. "Glass Curtain Wall: Plenty of Light, but Is It Soundtight?" Building Design + Construction, May 2, 2006. http://www.bdcnetwork.com/glass-curtain-wall-plenty-light-it-soundtight?page=1&quicktabs_1=1.

Bies, David A., and Colin H. Hansen. Engineering Noise Control: Theory and Practice. Taylor & Francis, 2009.

"BRE Group: Acoustics Laboratory." Accessed March 24, 2012. <http://www.bre.co.uk/page.jsp?id=1146>.

British Gypsum. "Education Sector Guide - 7 - Flanking Sound Transmission." British Gypsum, Saint-Gobain, March 2014. <http://www.british-gypsum.com/~media/Files/British-Gypsum/WHITE-BOOK-Sector-Guides/WBES/WBES-7-Flanking-Sound-Transmission-04.pdf>.

Cambridge, Jason Esan. "An Evaluation of Various Sound Insulation Programs and Their Use in the Design of Silent Rooms." Chalmers University of Technology, 2006.

Cox, Trevor. "Diffraction through a Single Slit." Wave Diffraction. Accessed July 18, 2014. <http://www.acoustics.salford.ac.uk/feschools/waves/diffract3.php>.

Crocker, Malcolm J. Handbook of Acoustics. John Wiley & Sons, 1998.

Dehghanyar, TJ. "Partition Mullions: Curtain Wall Acoustical Enhancements." Enclos Studio, January 29, 2009.

Dehghanyar, TJ, Mic Patterson, Kevin Cole, and Michel Michno. "Inter-Story Acoustical Evaluation of Unitized Curtain Wall Systems." Culver City, CA: Enclos Corp, July 2008.

DuPree, Russell B., and California. Dept. of Health Services. Office of Noise Control. Catalog of STC and IIC Ratings for Wall and Floor/ceiling Assemblies. Berkeley, California 94704: Office of Noise Control, California Department of Health Services, 1980.

Everest, F. Alton, and Ken C. Pohlmann. Master Handbook of Acoustics. McGraw-Hill Professional, 2009.

Gomperts, M.C., and T. Kihlman. "The Sound Transmission Loss of Circular and Slit-Shaped Apertures in Walls." Acta Acustica United with Acustica 18, no. 3 (1967): 144–50.

Halliwell, R.E., T. R. T. Nightingale, A.C.C Warnock, and J.A. Birta. "NRC-CNRC Gypsum Board Walls: Transmission Loss Data." Internal Report. Canada: Institute for Research in Construction, March 1998. <http://archive.nrc-cnrc.gc.ca/obj/irc/doc/pubs/ir/ir761/ir761.pdf>.

Hopkins, Carl. Sound Insulation. Elsevier / Butterworth-Heinemann, 2007.

ift Rosenheim. "Laboratory Building Acoustics." Accessed May 14, 2015. <https://www.ift-rosenheim.de/en/labor-bauakustik>.

ISO 12354-1:2000 Building Acoustics. Estimation of Acoustic Performance in Buildings from the Performance of Elements. Airborne Sound Insulation between Rooms. BSI, July 15, 2000.

Kym Burgemeister. "Sound Flanking at Curtain Wall Mullions." Arup Acoustics General Forum: Glazing and Facades, 2009.

Laing. "Systems for Facades, aluminum/PVC-U Windows and Doors - Fittings." Acoustic Laboratory Test. Insulation against Noise Transmission for Facades. Germany: Institute for Window Technology (ift) Rosenheim, November 13, 2000.

Lin, Man. "Chapter 6 Architectural Design, Computer Science CSci485." 2012. <http://cse.stfx.ca/~mlin/cs485/lectures/archdesign.ppt>.

Long, Marshall. Architectural Acoustics. Elsevier, 2006.

Louwers, Marc. "Improvement of Acoustical Flanking Transmission through Light-Weight Façades." In INTER-NOISE and NOISE-CON Congress and Conference Proceedings, 2012:1998–2003. 10. Institute of Noise Control Engineering, 2012.

LoVerde, John, and Wayland Dong. "Methods for Reducing Flanking Airborne Noise Transmission through Mullions of Curtain Wall Systems." The Journal of the Acoustical Society of America 124, no. 4 (2008): 2463.

Makepeace, Chris, Brian Kyle, Anik Shooner, and Luis de Miguel. Glass and Metal Curtain Walls: Best Practice Guide Building Technology. Public Works and Government Services Canada: Canada Mortgage and Housing Corporation, n.d. <http://www.tboake.com/guides/curtain.pdf>.

Martin, H.J., M.A.E. Schoffelen, and W.M. Siebesma. "Flanking Transmission along an Aluminium Façade – Experiments vs Prediction-." In Proceedings 17th International Congress on Acoustics Rome, Vol. 3. Rome, Italy, 2001.

"Flanking Transmission along an Aluminium Façade – Experiments vs Prediction-." In 18th Proceedings International Congress on Acoustics. Kyoto, 2004.

Mehta, Madan, James Allison Johnson, and Jorge Rocafort. Architectural Acoustics: Principles and Design. Prentice Hall, 1999.

Mommertz, Eckard. Acoustics and Sound Insulation: Principles, Planning, Examples. Birkhäuser, 2009.

Müller, W., and G. Vogel. *Atlante Di Architettura*. Milan: Hoepli, 1992.
<http://en.wikipedia.org/wiki/Mullion>.

Nagy, J.P. "Laboratory for Flanking Sound Transmission of Lightweight Constructions." *Civil Engineering* 18, no. 3 (1974): 169–78.

Nightingale, T. R. T. "On Using Multiple Kij's in the EN12354 Acoustics Prediction Model to Represent Excess Attenuation in Flanking Surfaces." Rome, Italy, 2001.

Parkin, Peter Hubert, Henry Robert Humphreys, and J.R. Cowell. *Acoustics, Noise, and Buildings*. Fourth Edition. Faber and Faber, Boston MA, 1979.

Patterson, Mic. "Structural Glass Facades." 2011.

Patterson, Mic. *Structural glass facades and enclosures*. John Wiley & Sons, 2011.

SaB, Bernd, and Ulrich Sieberath. "Classification Report, Sound Reduction and Flanking Transmission Loss of Building Elements." Acoustic Laboratory Test. Schuco Skyline S 65 F. Germany: ift Rosenheim, August 25, 2004.

Schüco. "Overview of Profiles for Schüco Facade USC 65." Accessed May 19, 2014.
http://schilloh.2netmedia.de/pdf/produkte/fassaden_daecher/172256.pdf.

Sjökvist, Lars-Göran. "Flanking Transmission in Lightweight Buildings." Lund University, Sweden: Department of Engineering Acoustics, 2004. <http://lup.lub.lu.se/record/929711>.

Smith, B. J., R. J. Peters, and S. Owen. *Acoustics and Noise Control*. 2 Sub. Addison Wesley Longman, 1996.

"Sound Insulation of the Original Component." Schüco, n.d. http://www.schueco.com/web2/de-en/investors/technology_center/specialist_areas.

Szudrowicz, B., and A. Izewwska. "Empirical Verification of the Prediction Model Designed to Estimate the Flanking Transmission in Buildings." In *Proceedings 17th International Congress on Acoustics Rome*, Vol. 3. Rome, Italy, 2001.

Tedford, Larry. "Sound Flanking at Curtain Wall Mullions." Arup Acoustics General Forum: Glazing and Facades, 2009.

T. Estabrooks, F. King. "NRC-IRC Flanking Sound Transmission Facility." National Research Council Canada, no. NRCC-51390 (October 2009): 3. doi:irc_id:20490.

Uris, Antonio, JoseMaria Bravo, Jaime Llinares, and Hermelando Estelles. "The Influence of Slits on Sound Transmission through a Lightweight Partition," 65:421–30. Elsevier Ltd., 2003.

Vigener, Nik, and Mark Brown. "Building Envelope Design Guide - Curtain Walls." Whole Building Design Guide: A Program of the National Institute of Building Sciences, October 20, 2011. http://www.wbdg.org/design/env_fenestration_cw.php.

Wamock, A.C.C, T. R. T. Nightingale, and M.R. Atif. "Estimation of Sound Transmission Class and Impact Insulation Class Rating for Steel Framed Assemblies." American Iron and Steel Institute / Steel Framing Alliance, 2008.

APPENDIX A TERMINOLOGY

A.1 LABORATORY TEST STANDARDS

ASTM E90

*ASTM E90 Test Method for Laboratory Measurement of Airborne Sound Transmission Loss of Building Partitions and Elements*⁷⁴

The laboratory test measurement procedure defines the airborne sound transmission loss of building elements. The test element is mounted in a filler wall between two reverberant chambers which isolate the sound source room from the sound receiving room. The test specimen is exposed to a diffuse sound field so that the performance may be compared to other specimens in a similar sound field. The significant path for sound transmission between the test chambers is through the specimen, which is mounted to the chamber filler wall with the intent to remove sound flanking paths. The sound transmission loss is based on one-third octave band center frequencies from 125 Hz to 4000 Hz. The TL is corrected for area of the specimen size and the absorption in the receiving room. The test method is used to calculate the single-figure STC per the ASTM 413 classification method.

ASTM E336

*ASTM E336 Standard Test Method for Measurement of Airborne Sound Attenuation between Rooms in Buildings*⁷⁵

The field test measurement procedure defines the sound isolation between two spaces in a building. The measurement includes the direct sound transmission through the separating building element and the transmission of various sound flanking paths. The procedure measures noise reduction (NR), normalized noise reduction (NNR) or apparent transmission loss (ATL). The corresponding single figure number rating to these measurements is NIC, NNIC, and ASTC. One of the significant differences between the E90 laboratory method and the E336 field method is the presence of sound flanking paths.

ASTM E413

*ASTM E413 Classification for Rating Sound Insulation*⁷⁶

The classification method used to calculate the single-figure number ratings for laboratory or field measurements of building elements in one-third octave bands. The calculation method covers the single figure number classification of the following test measurement methods:

- ASTM E90 laboratory test procedure for STC (Sound Transmission Class)
- ASTM E336 field test procedure for field sound transmission class (FSTC), noise isolation class (NIC), and normalized noise isolation class (NNIC).

⁷⁴ E33 Committee, "ASTM E90 - 09 Test Method for Laboratory Measurement of Airborne Sound Transmission Loss of Building Partitions and Elements," 90.

⁷⁵ E33 Committee, "ASTM E336 - 11 Standard Test Method for Measurement of Airborne Sound Attenuation between Rooms in Buildings."

⁷⁶ E33 Committee, "ASTM E413 -10 Classification for Rating Sound Insulation."

A.2 ACOUSTIC AND ARCHITECTURAL TERMS

ACOUSTICS

“Acoustics” is derived from the Greek word ‘akouein’, which means “to hear”, and is the branch of science that deals with sound, including its generation, transmission, analysis and perception⁷⁷.

ACOUSTIC LEAK

An acoustic leak occurs where a gap or hole in the construction occurs, whereas sound flanking is sound transmission through building components. (See sound flanking.)

ANECHOIC CHAMBER

A room devoid of sound reflections; designed so that all sound reflections are completely absorbed. Usually all six interior surfaces of the room are covered with special sound absorbing treatment.

ACOUSTIC PRIVACY

Obtaining acoustic privacy between adjacent spaces depends upon adequate sound isolation of the demising partition and an appropriate level of background noise in the receiving space. The level of acoustic privacy required for a space can be categorized by the used of the space. There are three major components that define acoustic privacy:

- the level of intrusive sound from the source
- the sound isolation between source and receiver spaces
- the background noise level at the receiver location

Background noise is the continuous HVAC system noise generated by fans and air velocities in ductwork and vents which often serves as masking noise, especially to provide acoustic privacy.

AIRBORNE SOUND

Speaking or playing music in a room causes the enclosing components to vibrate. These oscillations propagate within the construction (structure-borne noise) and are radiated in an adjacent room in the form of airborne sound. The sound propagation takes place not only via the separating component, but also via the adjoining, so called flanking components⁷⁸. Accordingly, building acoustics has to consider and evaluate both the separating and the flanking components. Airborne and structure-borne sound excitations often occur together. (Also see sound flanking.)

⁷⁷ Mommertz, *Acoustics and Sound Insulation*.

⁷⁸ Ibid.

CONNECTED MULLION

(See Unconnected Mullion) In the UVM testing phases, the “connected” mullion is described where the center vertical mullion is connected to the curtain wall glazing and horizontal mullions.

CURTAIN WALL SYSTEMS

- Non-Unitized Curtain Wall System
Non-unitized or ‘stick’ systems are curtain wall installations constructed from long vertical framing members called mullions, or sticks, spanning across supporting floor slabs. The framing members are shop fabricated, factory painted, and installed one piece at a time. The glass or other cladding panels are then attached to the framing members. The system type is site labor intensive. Consequently, stick systems have been replaced by unitized systems in many applications⁷⁹.

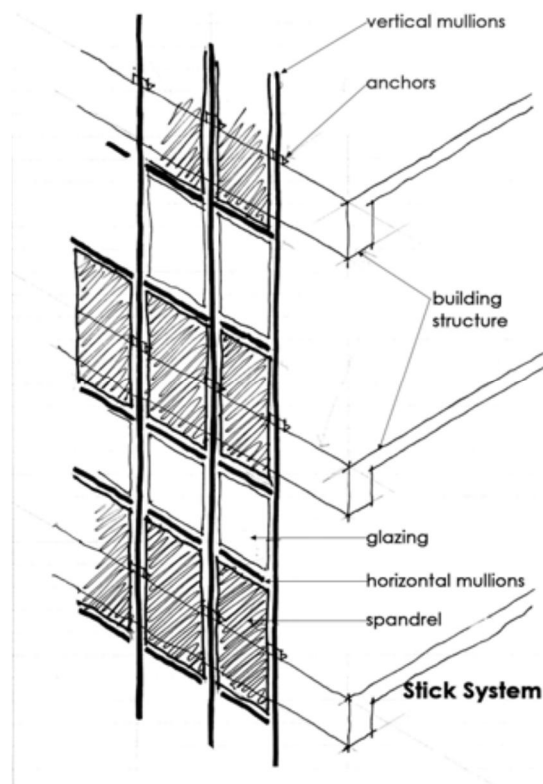

FIGURE A- 1: NON-UNITIZED (STICK) SYSTEM⁸⁰

- Unitized Curtain Wall System

⁷⁹ Mic Patterson, *Structural Glass Facades and Enclosures* (John Wiley & Sons, 2011), 36–37.

⁸⁰ Helmut Kientz, “Shedding Light on Curtain Wall Systems,” *HIXSON Architecture Engineering Interiors*, n.d., http://www.hixson-inc.com/_images/SheddingLight_Curtainwall_article0308.pdf.

Unitized systems are curtain wall systems where large framed units are built up under factory-controlled conditions, shipped to the site, and the entire unit lifted and set into position. Multiple glazing panels are typically incorporated within a single unit. Unitized systems strategically shift labor requirements from the site to the factory, which potentially allows improved quality and greater economy, at least in areas with high field labor rates.⁸¹

Normally the system is designed so that there is a continuous hollow cavity within the unitized frame system, both vertically and horizontally. This continuity creates a path for airborne and structure-borne sound to travel.

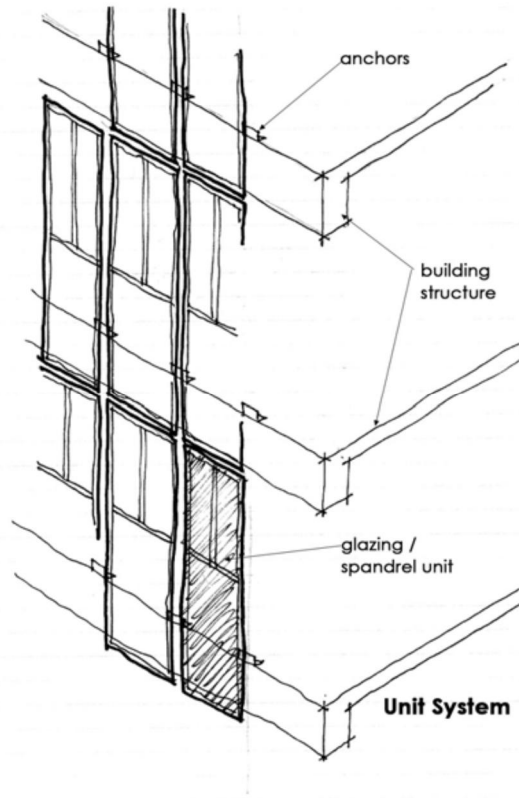

FIGURE A- 2: UNITIZED SYSTEM⁸²

DECIBEL, dBA

The unit used for measuring A-weighted sound pressure level is dB(A). The A-weighting is based on the frequency response of human hearing, where subjectively low frequency sounds do not seem as loud as mid- or high- frequency sounds for a given sound pressure level. The A-weightings curves which plot the

⁸¹ Patterson, *Structural Glass Facades and Enclosures*, 38.

⁸² Helmut Kientz, "Shedding Light on Curtain Wall Systems," *HIXSON Architecture Engineering Interiors*, n.d., http://www.hixson-inc.com/_images/SheddingLight_Curtainwall_article0308.pdf.

frequency response of human hearing are incorporated into sound level meters for direct measurement results measured in dB(A). Typical noise levels are given in the chart below that is widely used:

Noise Level dB(A)	Example
130	Threshold of pain
120	Jet aircraft take-off at 100 m
110	Chain saw at 1 m
100	Inside disco
90	Heavy truck at 5 m
80	Curbside of busy street
70	Loud radio (in typical domestic room)
60	Office or restaurant
50	Domestic fan heater at 1m
40	Living room
30	Theatre
20	Remote countryside on still night
10	Sound insulated test chamber
0	Threshold of hearing

TABLE A- 1: DECIBELS

EQUIVALENT CONTINUOUS SOUND LEVEL (L_{eq})

The equivalent noise level, L_{eq} , is the sound pressure level of a steady sound that has, over a given period, the same energy as the fluctuating sound in question. It is an average and is measured in dB(A).⁸³

FLANKING SOUND TRANSMISSION

Sound transmitted through flanking paths propagates acoustic vibration through a continuous structural component. In architecture, this typically occurs at a structural connection between two adjacent rooms which is rigid enough to transmit sound energy. Examples of sound flanking paths at a partition separating two spaces are at the ceiling, floor or intersecting walls if they are seamlessly connected between rooms. Specific conduits of sound flanking are rigid connections found at ducts, plumbing piping, electrical conduit, openings, structural elements, window mullions, etc.

Sound flanking paths reduce the sound transmission integrity of a partition because it circumvents a wall or floor between two spaces by way of an independent structural path. As a result the sound isolation performance of the demising wall is compromised.

⁸³ Smith, Peters, and Owen, *Acoustics and Noise Control*.

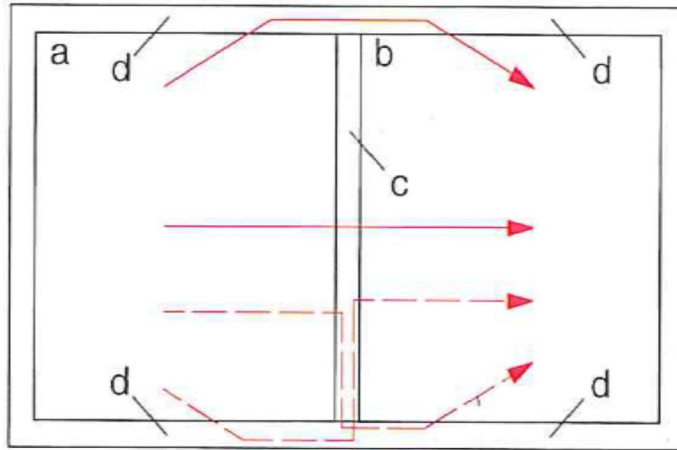

FIGURE A- 3: FLANKING PATH DIAGRAM (MOMMERTZ & MULLER, 2008)

The diagram in Figure A- 3: shows common paths of flanking. The red arrows represent the direction of sound energy propagating from the source to receiver rooms:⁸⁴

- a. Location of the source room
- b. Location of the receiving room
- c. The demising partition between the source and receiving room
- d. Partitions which are a continuous structural element between source and receiver rooms

FREQUENCY HZ

Frequency is cycles per second measured in Hertz (Hz), subjectively understood as pitch. The audible frequency range for human hearing is typically 20Hz – 20,000Hz.

- Speech Frequencies

Sound frequencies are a critical part of how humans perceive sound. Speech frequencies are the primary sounds we hear between office spaces, classrooms, or residential units. Speech frequencies are shown (Figure A-4). Speech frequencies are targeted for laboratory sound isolation tests for ASTM E90.

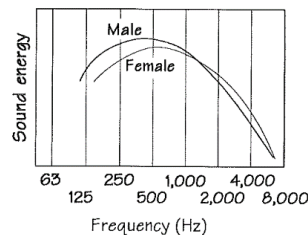

FIGURE A- 4: APPROXIMATE SOUND SPECTRA OF MALE AND FEMALE SPEECH (LOG-TERM AVERAGE)⁸⁵ (FROM MEHTA, ARCHITECTURAL ACOUSTICS PRINCIPLES AND DESIGN)

⁸⁴ Eckard Mommertz, *Acoustics and Sound Insulation: Principles, Planning, Examples* (Birkhäuser, 2009).

⁸⁵ Madan Mehta, James Allison Johnson, and Jorge Rocafort, *Architectural Acoustics: Principles and Design* (Prentice Hall, 1999).

MULLION

The aluminum extrusion that frames curtain wall glazing and runs vertically or horizontally.

NOISE

Noise is unwanted sound and provokes disturbance to human comfort and productivity. In the health industry this can have an adverse effect on healing process.

ONE-THIRD OCTAVE BANDS

Octave bands are referred to by their center frequency and are used to analyze acoustic measurements and calculations. Acoustics assessment is usually within the frequency range of human hearing, typically 63Hz to 8 kHz.

However, building acoustics frequency ranges are assessed in one-third octave bands (three frequency bands per octave) typically 100 to 3150Hz, for a more detailed frequency analysis. The extended frequency range is defined from 50 and 5000Hz one third octave bands. This is because airborne sound isolation performs better at high frequencies than at low frequencies, therefore airborne sound above 5000Hz is usually not a problem. It is common to describe specific trends in analyzing the spectral content of building Transmission Loss by defining low, medium and high frequency ranges.⁸⁶

Low frequency range: 500 – 200Hz

Mid frequency range: 250- 100Hz

High frequency range: 1250 – 5000Hz

OVERCLAD

The term used to enclose or wrap a mullion with a mass or damping building material.

PARTITION

The word “partition” in this standardized test methods includes all types of walls, floors, or any other boundaries separating two spaces. The boundaries may be permanent, operable, or movable⁸⁷.

PERCEPTION

- Auditive perception

Physical acoustic descriptions	Auditive human perception
<hr/>	
Frequency	Pitch
<hr/>	

⁸⁶ Hopkins, *Sound Insulation*.

⁸⁷ E33 Committee, *ASTM E336 - 11 Standard Test Method for Measurement of Airborne Sound Attenuation Between Rooms in Buildings* (ASTM International, 2011), <http://www.astm.org/Standards/E336.htm>.

Sound pressure level	Loudness
Combination of frequencies	Timbre

TABLE A- 2: PHYSICAL DESCRIPTIONS AND AUDITIVE PERCEPTION⁸⁸

- Loudness

Human perception of loudness is subjective. The subjective effect of sound pressure level changes are described (Table A-3). These ratings may be applied to relative differences between partition performances when making indicative comparisons.

Difference in Levels, dB (Increase or Decrease)	Apparent Loudness (Subjective Ratings)
1 dB	Just barely audible
3 dB	Just audible
5 dB	Clearly audible
10 dB	Subjective doubling of loudness (Half or twice as loud)
20 dB	Subjective four-fold increase in loudness (Much quieter or louder)

TABLE A- 3: SUBJECTIVE EFFECT OF CHANGES IN SOUND PRESSURE LEVEL⁸⁹⁹⁰

REVERBERATION

Reverberation in a space is dependent on the cubic volume and the amount of sound absorbing treatment applied to surfaces of a room. Reverberant spaces with multiple noise sources will increase noise buildup which can create a loud environment. Reverberant spaces can also reduce speech intelligibility.

REVERBERATION TIME (RT)

Reverberation time of an enclosed space is defined as the length of time taken in seconds for the sound pressure level to decrease by 60dB after the source sound has stopped. The RT is dependent upon the total sound absorbing surfaces and cubic volume of the space.

SOUND

Sound is pressure waves which occur through vibration travelling through a medium, either air or solid. The human ear perceives sounds through the fluctuation of pressure change at the ear drum. Sound can

⁸⁸ Ibid.

⁸⁹ Eckard Mommertz, *Acoustics and Sound Insulation: Principles, Planning, Examples* (Birkhäuser, 2009).

⁹⁰ David A. Bies and Colin H. Hansen, *Engineering Noise Control: Theory and Practice* (Spon Press, 2003).

be experienced through pressure changes in the air such as from a car horn or the structure borne from a vibrating diaphragm such as a drum.

SOUND PRESSURE LEVEL (L_p)

Sound is pressure waves. The human ear can accommodate an enormous range of pressures from the threshold of hearing 20μPa to the threshold of pain 100,000,000 μPa. A logarithmic measurement scale is used to accommodate sound pressures into levels using ratio of one to one million. The resulting parameter is sound pressure level (L_p) and the associated unit of sound measurement is decibel (dB), 0dB (threshold of hearing) to 140dB (threshold of pain).

STRUCTURE-BORNE SOUND

Where walls or suspended floors are not excited by airborne sound, but instead are caused to vibrate by way of direct mechanical actions, we speak of structure-borne sound. This is particularly the case when walking across a floor (impact sound), or when moving chairs, but also when operating building services. The sound transferred into components propagates through the construction as structure-borne sound and is radiated in neighboring rooms in the form of (secondary) airborne sound. Airborne and structure-borne sound excitations often occur together⁹¹.

SOUND ISOLATION

Sound isolation (sound insulation) is concerned with preventing sound propagation into a building and within a building, in order to avoid the spread of disturbing noise. Sound isolation is based the amount of noise transmitting through a wall or floor. All building partition elements and materials have an indicative sound isolation performance, e.g. STC rating. This acoustic design of sound insulation entails the arrangement of different functions within a building, and the design constructions and components of building partitions⁹².

SOUND ISOLATION RATING

Sound insulation ratings provide an indication of how well sound is transmitted through a barrier. The ratings are single figure numbers assigned to building elements such as, walls, floors, doors, windows, etc. Various rating types are given to building element to identify specific characters of their sound isolating properties. The rating descriptions vary between countries and are comparable, e.g. STC in the USA is the near equivalent to R_w used internationally.

STC (ASTM)

Sound Transmission Class (STC) is a single number rating used to describe the airborne sound Transmission Loss performance of a partition. The number rating is derived by comparing Transmission Loss values measured at 16 one-third octave bands (125 Hz – 4 kHz) to a reference curve.

⁹¹ Mommertz, *Acoustics and Sound Insulation*.

⁹² Ibid.

The STC value is obtained in accordance with ASTM E90 and ASTM E413. A higher STC rating indicates a better sound isolation performance.

FSTC (ASTM)

Transmission loss data obtained in the field is reported as Field Sound Transmission Class (FSTC). The FSTC value is obtained in accordance with ASTM E336.

$D_{nT,w}$ (ISO)

The sound isolation required between two spaces may be determined by the sound level difference needed between them. A single figure descriptor, the standardized weighted sound level difference, $D_{nT,w}$ is the index in the regulations (see BS EN ISO 717-1).

R_w (ISO)

The Transmission Loss of a building element is a measure of the loss of sound through the barrier. It is similar to STC in that the rating is a characteristic of the building component and not affected by the common area between the rooms and the room acoustic of the receiving room as opposed to $D_{nT,w}$. The weighted sound reduction index R_w is a single figure description of the sound reduction index defined in BS EN ISO 717-1:1997.

SOUND LEVEL

The unit of measurement for sound levels is the decibel, (dB). The human threshold of hearing is 0 decibels and the human threshold of pain is approximately 130dB. Normal conversational speech is approximately 50dB.

TRANSOM

Horizontal Mullion

TRANSMISSION LOSS, TL

Sound can reach an occupied room by propagating through the air or through vibration paths traveling within the building structure. These two forms of sound propagation are referred to as airborne or structure-borne sound.

Airborne sound isolation of a building element, such as a vertical mullion, depends upon some of the following characteristics:

- The mass (lbs/ft²) of the mullion
- The depth of the air space between both sides of the mullion
- The structural connection mechanically fastening both sides of mullion together
- The amount of sound absorption in the air space of the mullion
- Transmission Loss is dependent on damping, mass and coincidence effect

- Laboratory Transmission Loss Test

The transmission loss of a panel is measured in octave bands by comparing the level in the source room with the level in the receiving room. The results are normalized for the area of the partition and the absorption in the receiving room. The test is conducted in a reverberation chamber

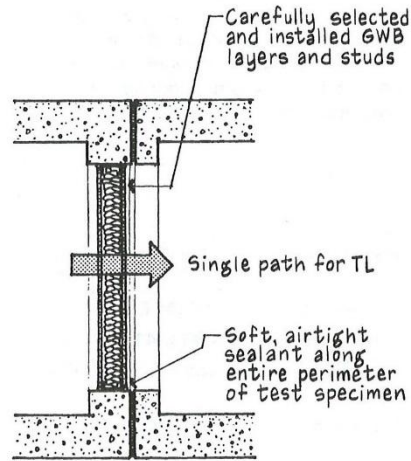
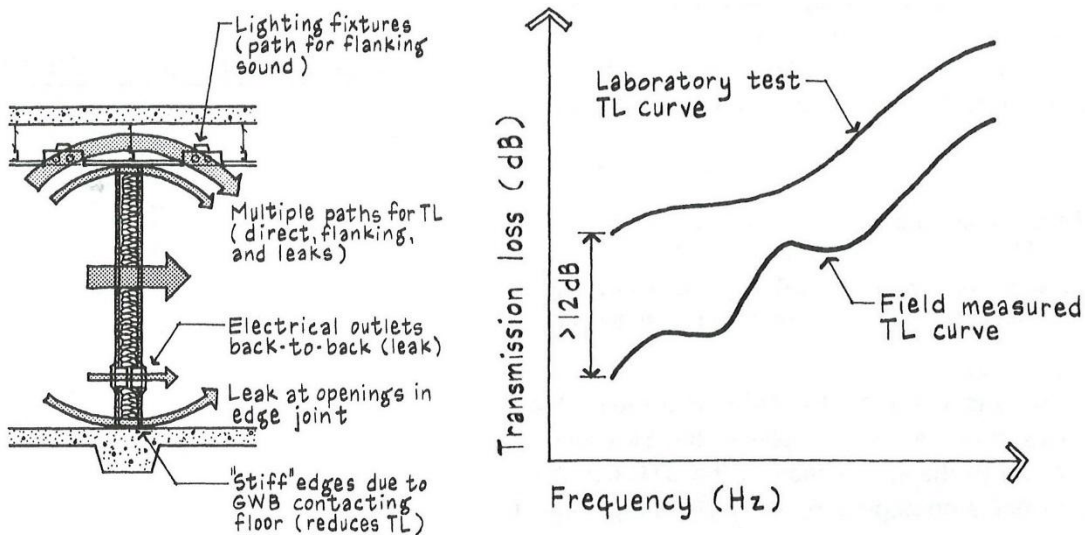

FIGURE A- 5: SECTION OF LABORATORY TRANSMISSION LOSS TESTING CHAMBER⁹³

- Field Transmission Loss Test

While laboratory represent “idealized conditions” in-site conditions are different. Inevitably there is a reduction in the apparent Transmission Loss performance of the partition due to flanking and sound leakage. A 5 to 10 dB loss based on the lab tested insulation value is common.



⁹³ M. David Egan, *Architectural Acoustics* (J. Ross Publishing, 2007).

FIGURE A- 6: FIELD CONDITION FOR IN-SITU TRANSMISSION LOSS TESTING⁹⁴.

FIGURE A- 7: DIFFERENCE BETWEEN LABORATORY AND FIELD TRANSMISSION LOSS TESTS⁹⁵.

UNCONNECTED MULLION

(See Connected Mullion) In the UVM testing phases, the “unconnected” mullion is described where the center vertical mullion is separated from the curtain wall glazing and horizontal mullions.

VIBRATIONS

Vibrations are generally low-frequency structure-borne sound excitations (below about 63 Hz) which, for example, are caused by trains, construction activities or industrial operations. If such vibrations could have negative effects for people, historical buildings or sensitive laboratory apparatus, dynamic analyses are usually required⁹⁶.

⁹⁴ Ibid.

⁹⁵ Ibid.

⁹⁶ Mommertz, *Acoustics and Sound Insulation*.

APPENDIX B UVM LABORATORY TEST RESULTS

B.1 INTRODUCTION

Laboratory transmission loss test reports of all tests in the UVM phase are provided. All tests are in accordance with ASTM E90 *Test Method for Laboratory Measurement of Airborne Sound Transmission Loss of Building Partitions and Elements*.

TEST PHASE	MEASURED SPECIMENS (ISOLATED AND COMPOSITE)			WEAL TEST NUMBER
	Mullion	Connection	Glass Curtain Wall	
PHASE 1	●			TL13-309 – TL13-330
PHASE 2A	●	●		TL13-398 – TL13-423
PHASE 2B		●		TL13-605 – TL13-633
PHASE 3	●		●	TL14-197 – TL14-171

TABLE B- 1: WEAL TEST NUMBERS AT EACH PHASE

B.1.1 Test Measurement Standards

Test procedures is in accordance with ASTM E90-1990. STC ratings are in accordance with E413-1987.

B.2 PHASE 1 WEAL TEST RESULTS

Test Number	STC	Class	Mullion	Fill	Cladding
TL13-309	37	A	bare mullion - flush src room	none	none
TL13-310	34	A	bare mullion - center position	none	none
TL13-311	36	A	mullion with gasket	none	none
TL13-312	47	A	mullion separated by 1"	none	none
TL13-313	39	B	mullion with gasket	bags of pea gravel	none
TL13-314	38	B	mullion with gasket	bags of sand	none
TL13-315	36	B	mullion with gasket	mineral fiber	none
TL13-316	38	B	mullion with gasket	mass loaded vinyl pillows	none
TL13-317	46	C1	mullion with gasket	mass loaded vinyl pillows	1/8" aluminum plate over mass loaded vinyl
TL13-318/319	48	C1	mullion with gasket	none	1/8" aluminum plate over mass loaded vinyl
TL13-320	46	C1	mullion with gasket	pea gravel	1/8" aluminum plate over mass loaded vinyl
TL13-321	50	C2	mullion with gasket	none	5/8" gypsum board over mass loaded vinyl
TL13-322	47	C2	mullion with gasket	pea gravel	5/8" gypsum board over mass loaded vinyl
TL13-323	52	C2	mullion with gasket	mass loaded vinyl pillows	5/8" gypsum board over mass loaded vinyl
TL13-324	47	C3	mullion with gasket	mass loaded vinyl pillows	5/8" gypsum board
TL13-325	42	C3	mullion with gasket	none	5/8" gypsum board
TL13-326	45	C3	mullion with gasket	pea gravel	5/8" gypsum board
TL13-327	31	C4	mullion with gasket	none	1-1/2" alum tube with PAC isolators
TL13-328	38	C4	mullion with gasket	MLV in tubes	1-1/2" alum tube with PAC isolators
TL13-329	48	C4	mullion with gasket	MLV and mineral fiber in tubes	1-1/2" alum tube with PAC isolators
TL13-330	48	C4	mullion with gasket	MLV and mineral fiber in tubes	1-1/2" alum tube with MLV isolators

TABLE B- 2: PHASE 1 WEAL TEST NUMBERS, AREA AND DESCRIPTION

1/2" MILLION
FLUSH W/ SOURCE SIDE

WESTERN ELECTRO-ACOUSTIC LABORATORY

Report No. TL13-309

10:55am
28 MAY 2013

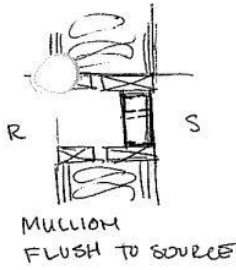

TRANSMISSION LOSS IN DECIBELS

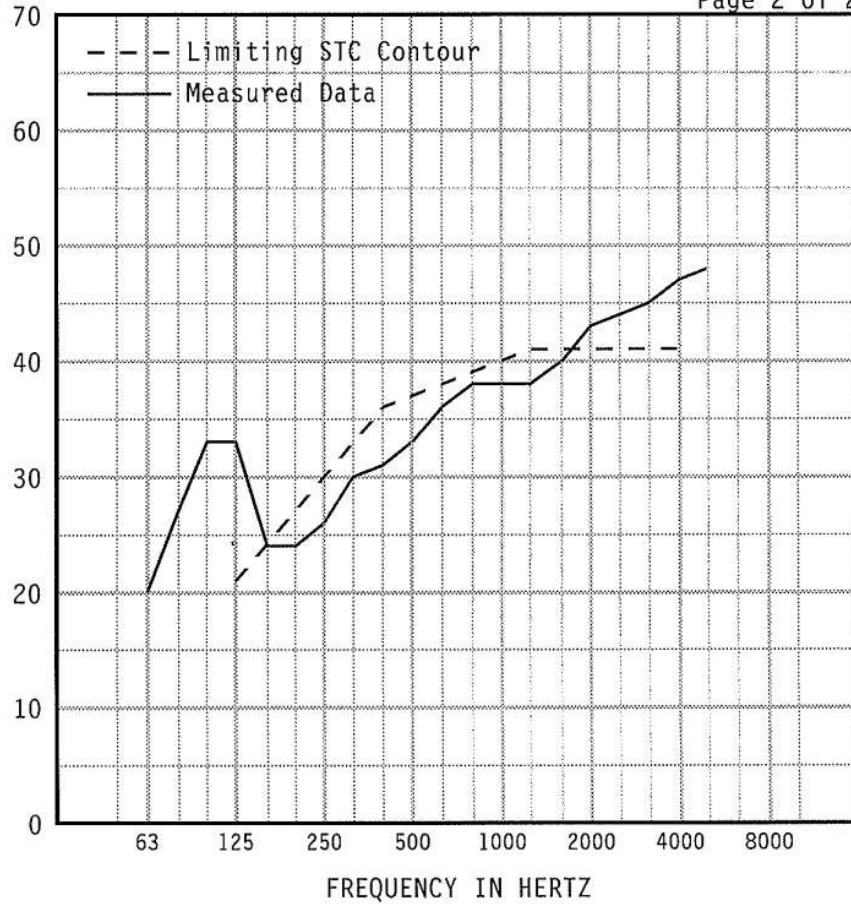

Page 2 of 2

1/3 OCT BND CNTR FREQ	63	80	100	125	160	200	250	315	400	500
TL in dB	*20	*27	*33	*33	24	24	26	30	31	33
95% Confidence in dB deficiencies	1.42	1.92	2.07	1.47	0.89 (0)	0.76 (3)	0.80 (4)	0.52 (3)	0.36 (5)	0.38 (4)
1/3 OCT BND CNTR FREQ	630	800	1000	1250	1600	2000	2500	3150	4000	5000
TL in dB	36	38	38	38	40	43	44	45	47	48
95% Confidence in dB deficiencies	0.29 (2)	0.44 (1)	0.38 (2)	0.39 (3)	0.36 (1)	0.56	0.55	0.31	0.32	0.50

EWR	OITC	* Minimum estimate of transmission loss. Measurement limited by filler wall. Actual TL will be equal to or greater than value reported.	Specimen Area: 2.81 sq.ft. Temperature: 73.4 deg. F Relative Humidity: 39 % Test Date: 28 May 2013	STC
38	32			37 (28)

Report must be distributed in its entirety except with written authorization from Western Electro-Acoustic Laboratory

WESTERN ELECTRO-ACOUSTIC LABORATORY

Report No. TL13-310

11:40am

28 MAY 2013

Page 2 of 2

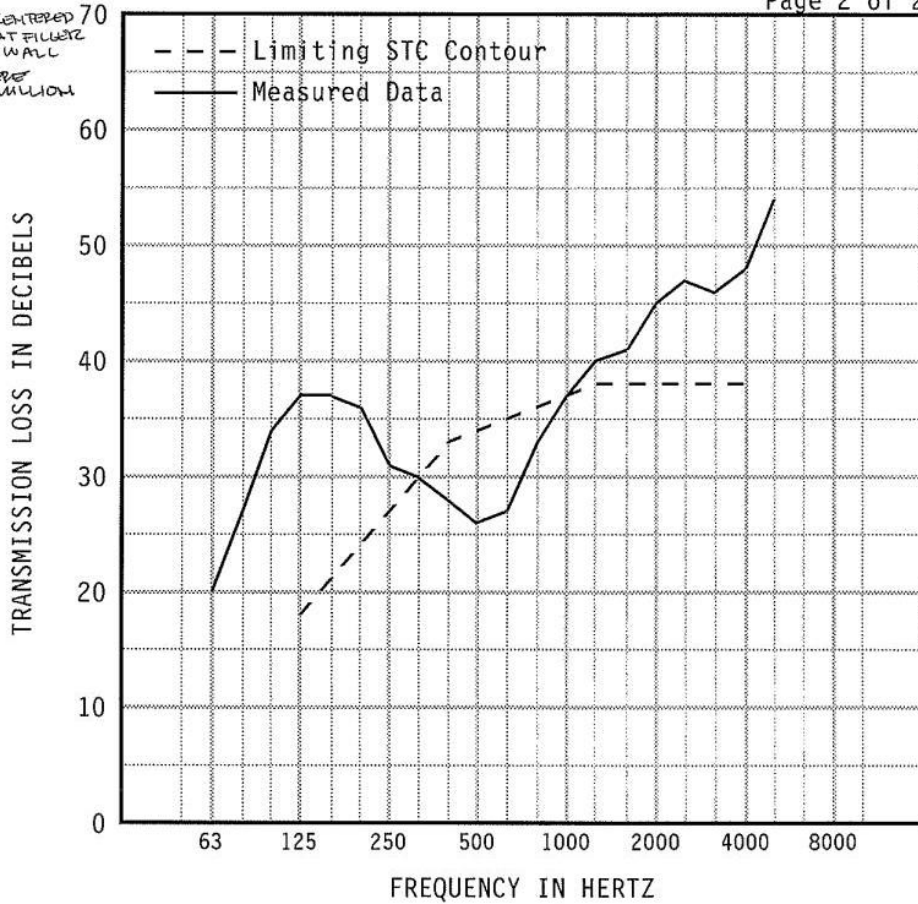
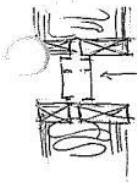

1/3 OCT BND CNTR FREQ	63	80	100	125	160	200	250	315	400	500
TL in dB	*20	*27	*34	*37	*37	*36	31	30	28	26
95% Confidence in dB deficiencies	1.42	1.92	2.07	1.47	0.89	0.76	0.80	0.52 (0)	0.36 (5)	0.38 (8)
1/3 OCT BND CNTR FREQ	630	800	1000	1250	1600	2000	2500	3150	4000	5000
TL in dB	27	33	37	40	41	45	47	46	48	54
95% Confidence in dB deficiencies	0.29 (8)	0.44 (3)	0.38 (0)	0.39	0.36	0.56	0.55	0.31	0.32	0.50

EWR	OITC
36	32

* Minimum estimate of transmission loss. Measurement limited by filler wall. Actual TL will be equal to or greater than value reported.

Specimen Area: 2.81 sq.ft.
 Temperature: 73.6 deg. F
 Relative Humidity: 40 %
 Test Date: 28 May 2013

STC
34
(24)

Report must be distributed in its entirety except with written authorization from Western Electro-Acoustic Laboratory

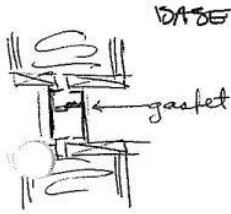

WESTERN ELECTRO-ACOUSTIC LABORATORY

Report No. TL13-311

1:00pm
28 May 2013

Page 2 of 2

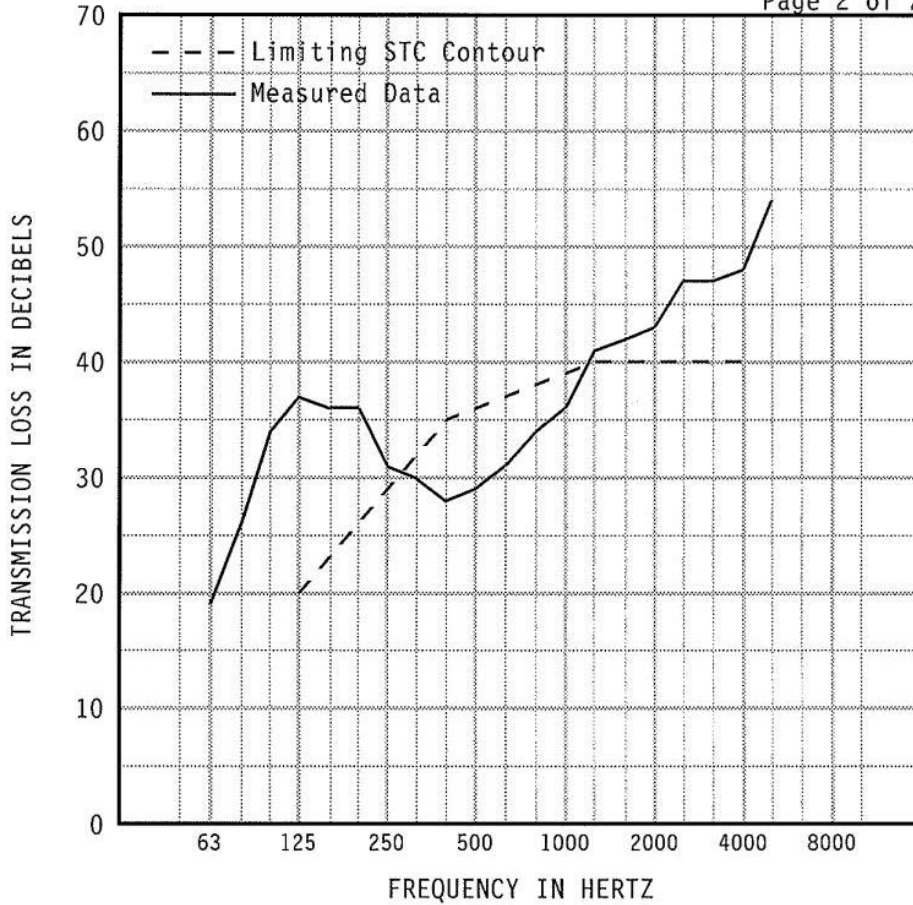

1/3 OCT BND CNTR	FREQ	63	80	100	125	160	200	250	315	400	500
TL in dB		*19	*26	*34	*37	*36	*36	31	30	28	29
95% Confidence in dB deficiencies		1.42	1.92	2.07	1.47	0.89	0.76	0.80	0.52 (2)	0.36 (7)	0.38 (7)
1/3 OCT BND CNTR	FREQ	630	800	1000	1250	1600	2000	2500	3150	4000	5000
TL in dB		31	34	36	41	42	43	47	47	48	54
95% Confidence in dB deficiencies		0.29 (6)	0.44 (4)	0.38 (3)	0.39	0.36	0.56	0.55	0.31	0.32	0.50

EWR	OITC
37	33

* Minimum estimate of transmission loss. Measurement limited by filler wall. Actual TL will be equal to or greater than value reported.

Specimen Area: 2.81 sq.ft.
Temperature: 73.8 deg. F
Relative Humidity: 40 %
Test Date: 28 May 2013

STC
36
(29)

Report must be distributed in its entirety except with written authorization from Western Electro-Acoustic Laboratory

air space

WESTERN ELECTRO-ACOUSTIC LABORATORY

Report No. TL13-312

2:15 pm
28 May 2013

Page 2 of 2

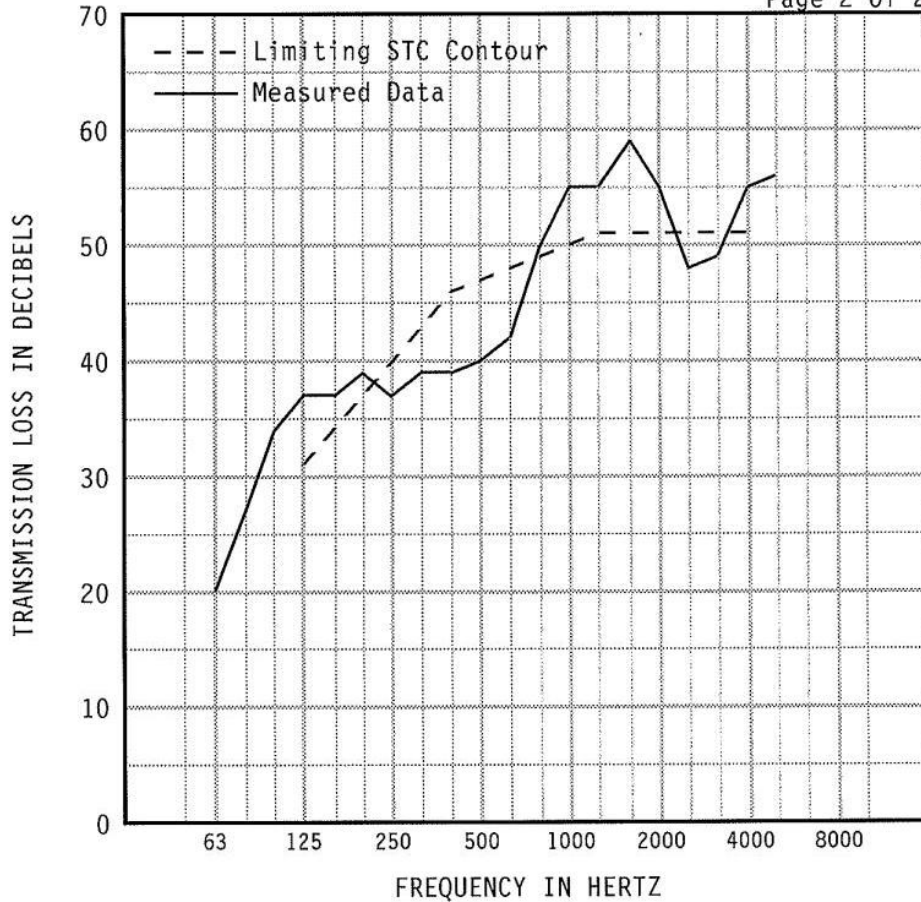

1/3 OCT BND CNTR FREQ	63	80	100	125	160	200	250	315	400	500
TL in dB	*20	*27	*34	*37	*37	*39	37	39	39	40
95% Confidence in dB deficiencies	1.42	1.92	2.07	1.47	0.89	0.76	0.80 (3)	0.52 (4)	0.36 (7)	0.38 (7)
1/3 OCT BND CNTR FREQ	630	800	1000	1250	1600	2000	2500	3150	4000	5000
TL in dB	42	50	*55	*55	*59	*55	48	49	55	56
95% Confidence in dB deficiencies	0.29	0.44	0.38	0.39	0.36	0.56	0.55 (3)	0.31 (2)	0.32	0.50

EWR	OITC
47	40

* Minimum estimate of transmission loss. Measurement limited by filler wall. Actual TL will be equal to or greater than value reported.

Specimen Area: 2.81 sq.ft.
Temperature: 73.9 deg. F
Relative Humidity: 39 %
Test Date: 28 May 2013

STC
47 (32)

Report must be distributed in its entirety except with written authorization from Western Electro-Acoustic Laboratory

CLASS B
gravel Fin

WESTERN ELECTRO-ACOUSTIC LABORATORY

Report No. TL13-313

3:10
28 May 2013

49.5 total
lbs
million
+
gravel

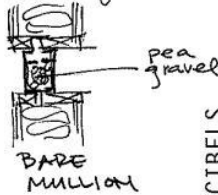

Page 2 of 2

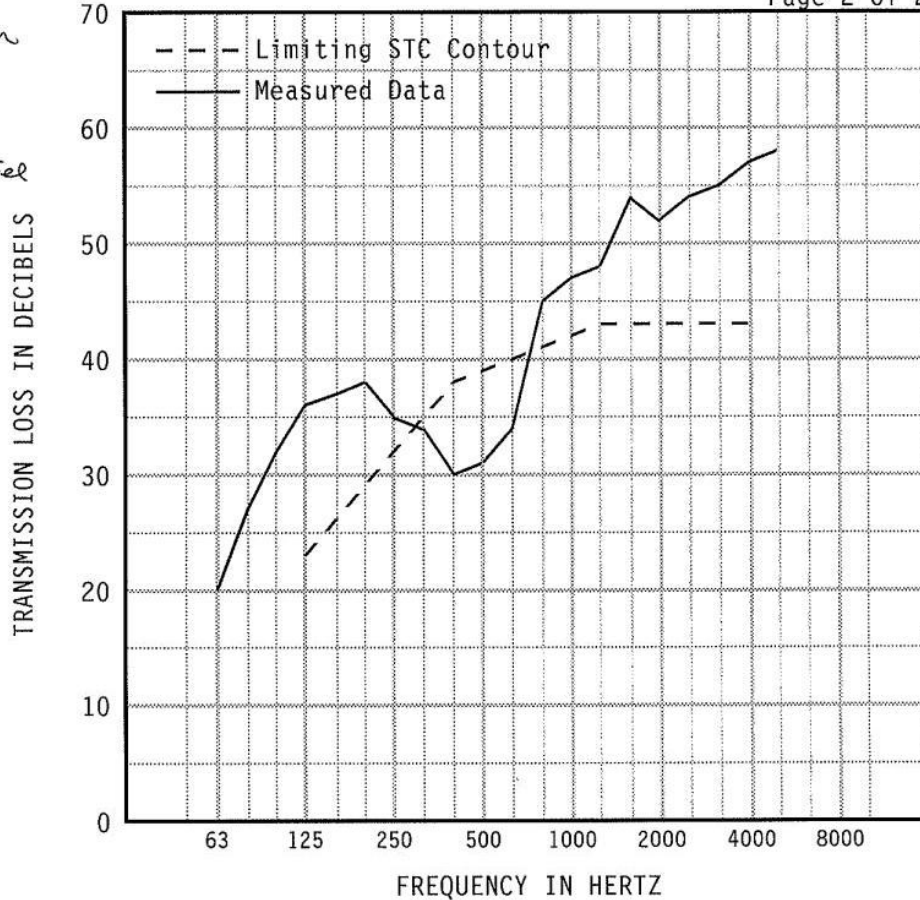

1/3 OCT BND CNTR	FREQ	63	80	100	125	160	200	250	315	400	500
TL in dB		*20	*27	*32	*36	*37	*38	35	34	30	31
95% Confidence in dB		1.42	1.92	2.07	1.47	0.89	0.76	0.80	0.52	0.36	0.38
deficiencies									(1)	(8)	(8)
1/3 OCT BND CNTR	FREQ	630	800	1000	1250	1600	2000	2500	3150	4000	5000
TL in dB		34	45	47	48	54	52	54	55	57	58
95% Confidence in dB		0.29	0.44	0.38	0.39	0.36	0.56	0.55	0.31	0.32	0.50
deficiencies		(6)									

EWR	OITC
41	36

* Minimum estimate of transmission loss. Measurement limited by filler wall. Actual TL will be equal to or greater than value reported.

Specimen Area: 2.81 sq.ft.
Temperature: 74.1 deg. F
Relative Humidity: 40 %
Test Date: 28 May 2013

STC
39
(23)

Report must be distributed in its entirety except with written authorization from Western Electro-Acoustic Laboratory

CLASS B

WESTERN ELECTRO-ACOUSTIC LABORATORY

Report No. TL13-314

7-107 m
28 MAY 2013

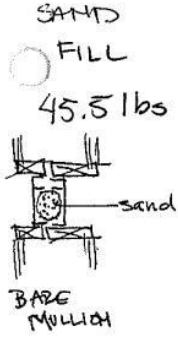

Page 2 of 2

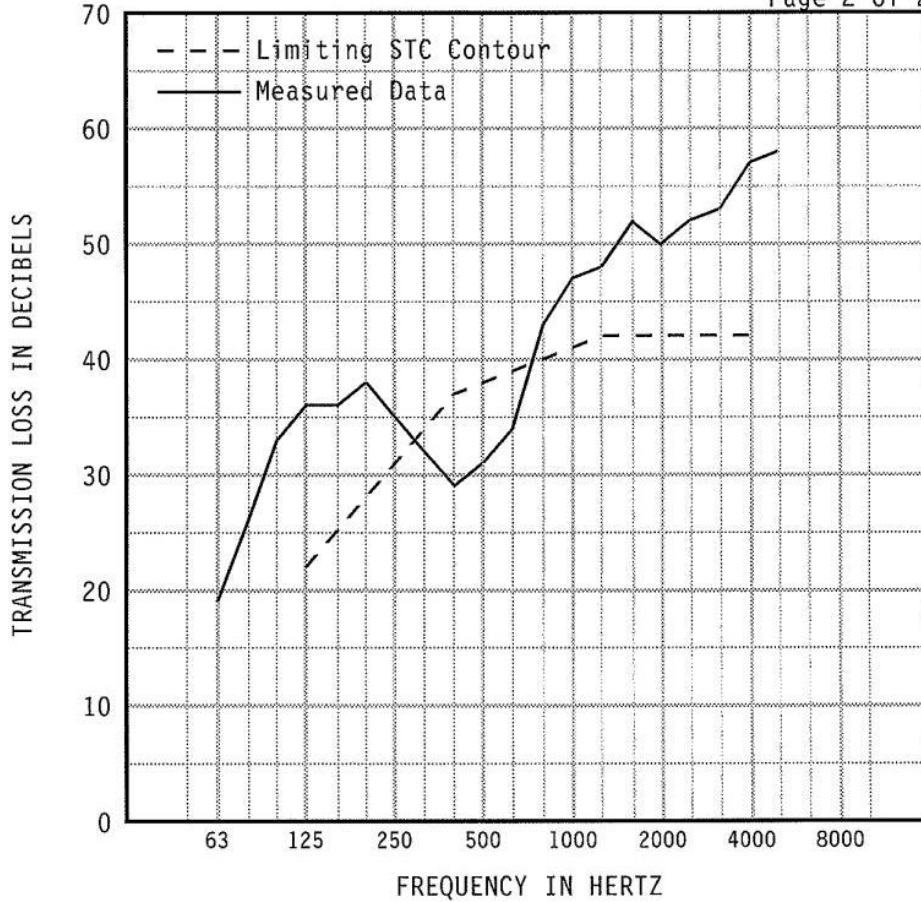

1/3 OCT BND CNTR FREQ	63	80	100	125	160	200	250	315	400	500
TL in dB	*19	*26	*33	*36	*36	*38	35	32	29	31
95% Confidence in dB deficiencies	1.42	1.92	2.07	1.47	0.89	0.76	0.80	0.52 (2)	0.36 (8)	0.38 (7)
1/3 OCT BND CNTR FREQ	630	800	1000	1250	1600	2000	2500	3150	4000	5000
TL in dB	34	43	47	48	52	50	52	53	57	58
95% Confidence in dB deficiencies	0.29 (5)	0.44	0.38	0.39	0.36	0.56	0.55	0.31	0.32	0.50

EWR	OITC	* Minimum estimate of transmission loss. Measurement limited by filler wall. Actual TL will be equal to or greater than value reported.	Specimen Area: 2.81 sq.ft. Temperature: 74.1 deg. F Relative Humidity: 39 % Test Date: 28 May 2013	STC 38 (22)
41	35			

Report must be distributed in its entirety except with written authorization from Western Electro-Acoustic Laboratory

CLASS B
FIBERGLASS
FILL

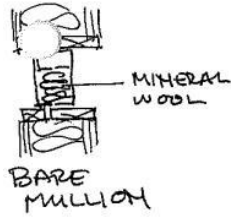

WESTERN ELECTRO-ACOUSTIC LABORATORY

Report No. TL13-315

Page 2 of 2

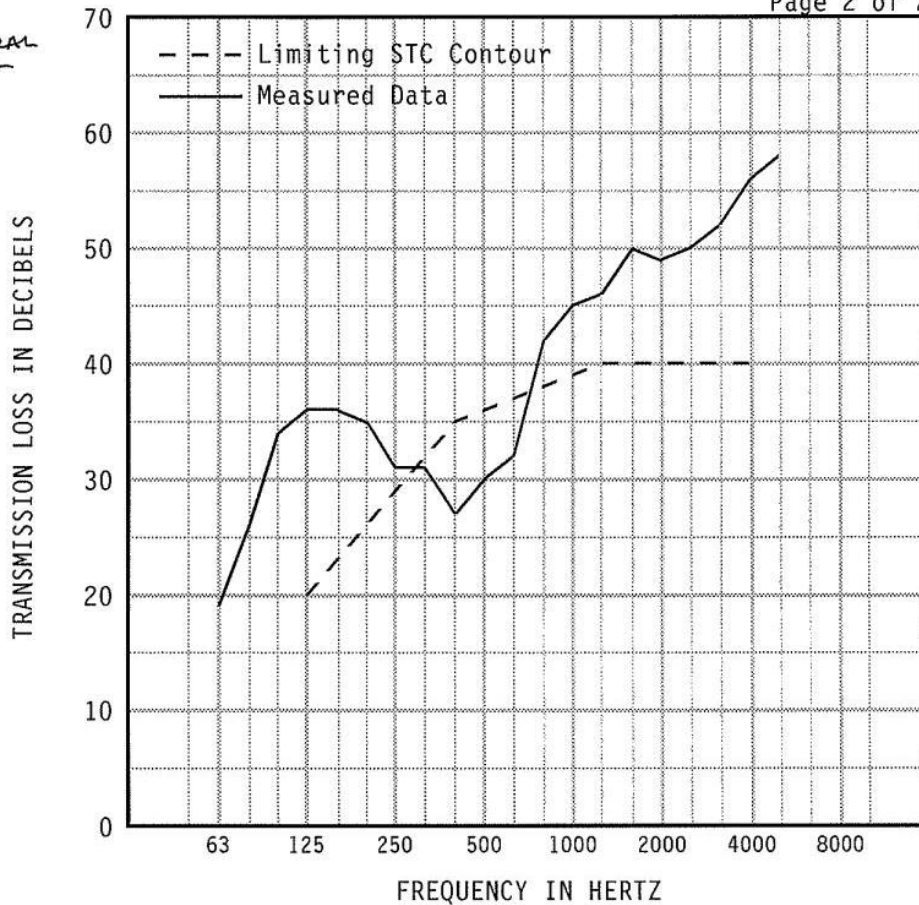

1/3 OCT BND CNTR FREQ	63	80	100	125	160	200	250	315	400	500
TL in dB	*19	*26	*34	*36	*36	35	31	31	27	30
95% Confidence in dB deficiencies	1.42	1.92	2.07	1.47	0.89	0.76	0.80	0.52 (1)	0.36 (8)	0.38 (6)
1/3 OCT BND CNTR FREQ	630	800	1000	1250	1600	2000	2500	3150	4000	5000
TL in dB	32	42	45	46	50	49	50	52	56	58
95% Confidence in dB deficiencies	0.29 (5)	0.44	0.38	0.39	0.36	0.56	0.55	0.31	0.32	0.50

EWR	OITC	* Minimum estimate of transmission loss. Measurement limited by filler wall. Actual TL will be equal to or greater than value reported.	Specimen Area: 2.81 sq.ft. Temperature: 74.1 deg. F Relative Humidity: 39 % Test Date: 28 May 2013	STC
39	34			36 (20)

Report must be distributed in its entirety except with written authorization from Western Electro-Acoustic Laboratory

CLASS B
MLV
PILLOW
FILL
04.5165

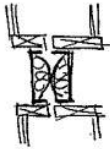

BARE
MULLION

WESTERN ELECTRO-ACOUSTIC LABORATORY

Report No. TL13-316

30 MAY 2013
10:15am

Page 2 of 2

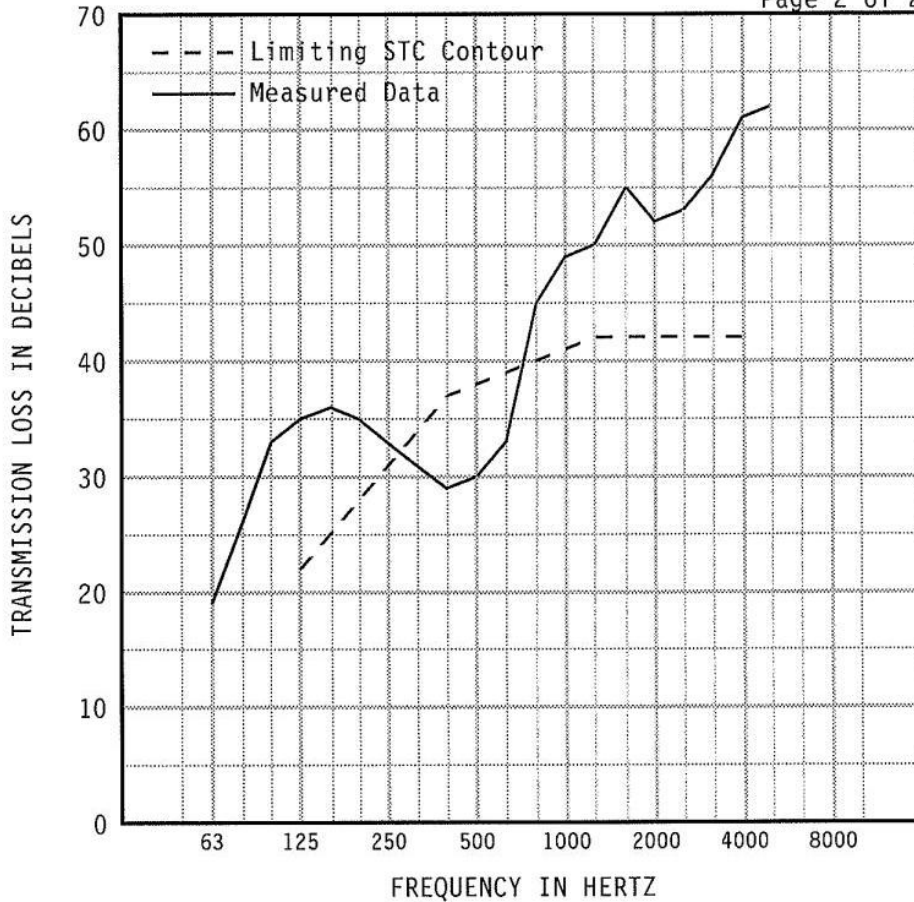

1/3 OCT BND CNTR	FREQ	63	80	100	125	160	200	250	315	400	500
TL in dB		*19	*26	*33	*35	*36	35	33	31	29	30
95% Confidence in dB deficiencies		1.42	1.92	2.07	1.47	0.89	0.76	0.80	0.52 (3)	0.36 (8)	0.38 (8)
1/3 OCT BND CNTR	FREQ	630	800	1000	1250	1600	2000	2500	3150	4000	5000
TL in dB		33	45	49	50	55	52	53	56	*61	*62
95% Confidence in dB deficiencies		0.29 (6)	0.44	0.38	0.39	0.36	0.56	0.55	0.31	0.32	0.50

EWR	OITC	* Minimum estimate of transmission loss. Measurement limited by filler wall. Actual TL will be equal to or greater than value reported.	Specimen Area: 2.81 sq.ft. Temperature: 73.9 deg. F Relative Humidity: 39 % Test Date: 30 May 2013	STC
40	35			38 (25)

Report must be distributed in its entirety except with written authorization from Western Electro-Acoustic Laboratory

CLASS C

MLV PILLOWS

W/ 1/8" ALUM. PLATE

○ MLV PLATE

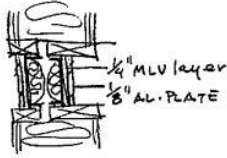

WESTERN ELECTRO-ACOUSTIC LABORATORY

Report No. TL13-317

11:45am
30 May 2013

Page 2 of 2

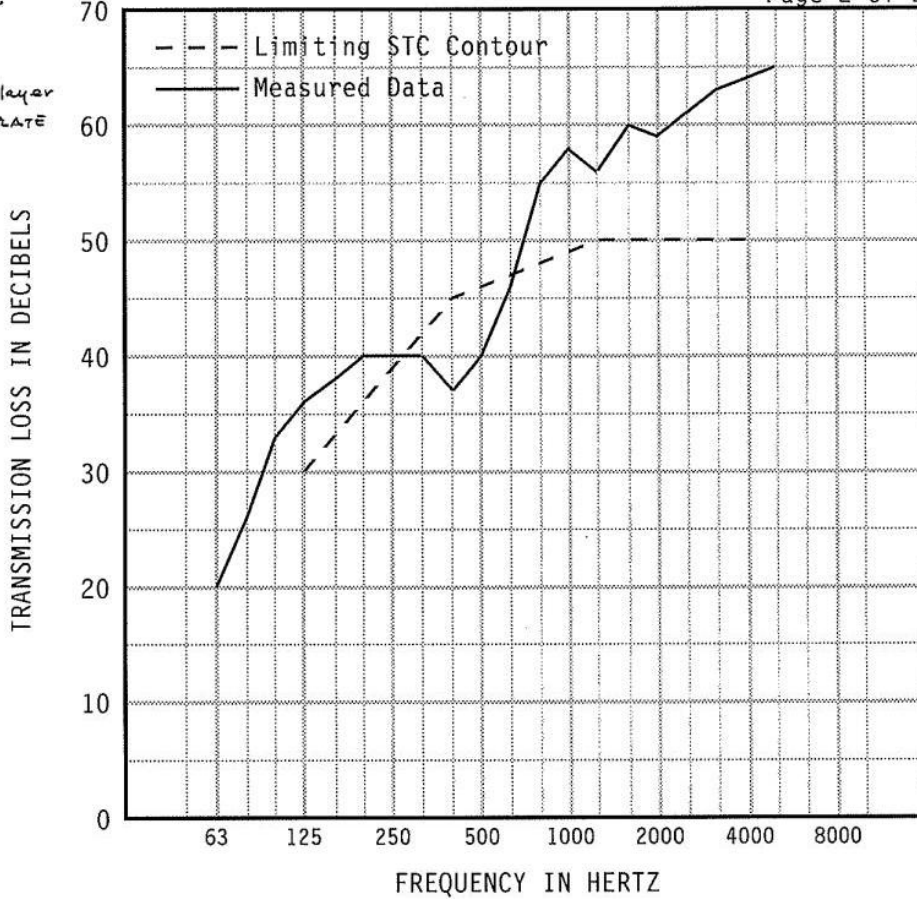

1/3 OCT BND CNTR FREQ	63	80	100	125	160	200	250	315	400	500
TL in dB	*20	*26	*33	*36	*38	*40	*40	40	37	40
95% Confidence in dB deficiencies	1.42	1.92	2.07	1.47	0.89	0.76	0.80	0.52 (2)	0.36 (8)	0.38 (6)
1/3 OCT BND CNTR FREQ	630	800	1000	1250	1600	2000	2500	3150	4000	5000
TL in dB	46	*55	*58	*56	*60	*59	*61	*63	*64	*65
95% Confidence in dB deficiencies	0.29 (1)	0.44	0.38	0.39	0.36	0.56	0.55	0.31	0.32	0.50

EWR	OITC	* Minimum estimate of transmission loss. Measurement limited by filler wall. Actual TL will be equal to or greater than value reported.	Specimen Area: 2.81 sq.ft. Temperature: 74.3 deg. F Relative Humidity: 38 % Test Date: 30 May 2013	STC
48	41			46 (17)

Report must be distributed in its entirety except with written authorization from Western Electro-Acoustic Laboratory

CLASS B

HOLLOW MULLION

OVERGLAZED: MLV + 1/8" ALUM

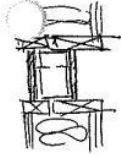

WESTERN ELECTRO-ACOUSTIC LABORATORY

Report No. TL13-318

12:50 am

30 May 2013

Page 2 of 2

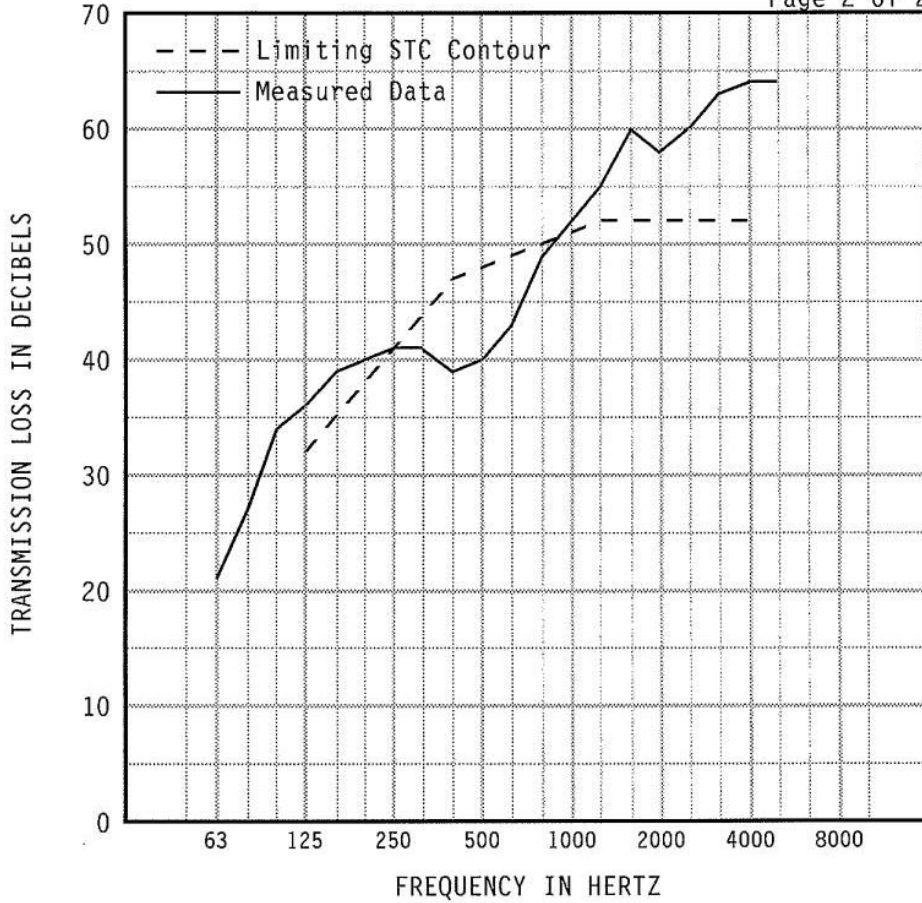

1/3 OCT BND CNTR FREQ	63	80	100	125	160	200	250	315	400	500
TL in dB	*21	*27	*34	*36	*39	*40	*41	*41	39	40
95% Confidence in dB deficiencies	1.42	1.92	2.07	1.47	0.89	0.76	0.80	0.52	0.36	0.38
							(0)	(3)	(8)	(8)
1/3 OCT BND CNTR FREQ	630	800	1000	1250	1600	2000	2500	3150	4000	5000
TL in dB	43	49	52	*55	*60	*58	*60	*63	*64	*64
95% Confidence in dB deficiencies	0.29	0.44	0.38	0.39	0.36	0.56	0.55	0.31	0.32	0.50
	(6)	(1)								

EWR	OITC	* Minimum estimate of transmission loss. Measurement limited by filler wall. Actual TL will be equal to or greater than value reported.	Specimen Area: 2.81 sq.ft. Temperature: 74.3 deg. F Relative Humidity: 38 % Test Date: 30 May 2013	STC
49	41			48 (26)

Report must be distributed in its entirety except with written authorization from Western Electro-Acoustic Laboratory

SAME
AS TL13-318

WESTERN ELECTRO-ACOUSTIC LABORATORY

Report No. TL13-319

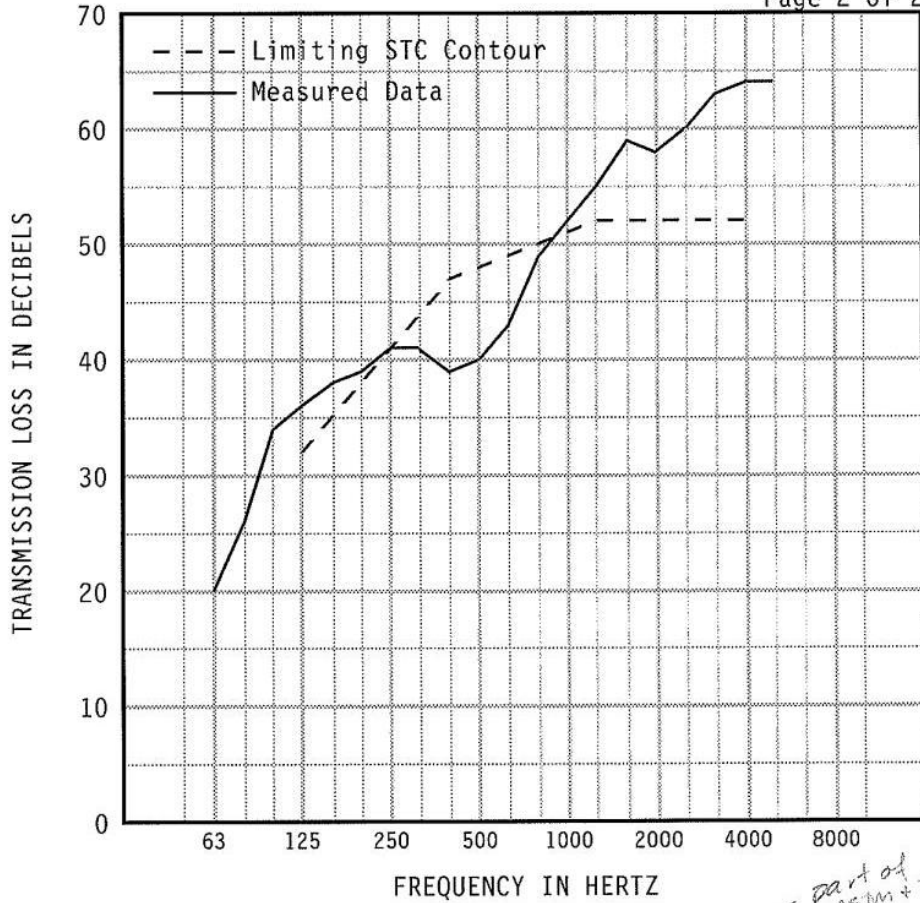

1/3 OCT BND CNTR FREQ	63	80	100	125	160	200	250	315	400	500
TL in dB	*20	*26	*34	*36	*38	*39	*41	*41	39	40
95% Confidence in dB deficiencies	1.42	1.92	2.07	1.47	0.89	0.76	0.80	0.52	0.36	0.38
							(0)	(3)	(8)	(8)
1/3 OCT BND CNTR FREQ	630	800	1000	1250	1600	2000	2500	3150	4000	5000
TL in dB	43	49	52	*55	*59	*58	*60	*63	*64	*64
95% Confidence in dB deficiencies	0.29	0.44	0.38	0.39	0.36	0.56	0.55	0.31	0.32	0.50
	(6)	(1)								

*part of
ASIM + TL of
filler*

EWR	OITC	* Minimum estimate of transmission loss. Measurement limited by filler wall. Actual TL will be equal to or greater than value reported.	Specimen Area: 2.81 sq.ft. Temperature: 74.3 deg. F Relative Humidity: 38 % Test Date: 30 May 2013	STC
48	41			48 (26)

Report must be distributed in its entirety except with written authorization from Western Electro-Acoustic Laboratory

CLASS ~~B~~
 GRAVEL FILL
 OVERCLAD:
 MLV + 1/8" PLATE

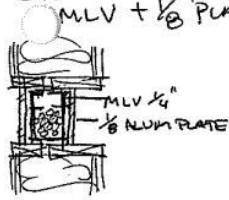

WESTERN ELECTRO-ACOUSTIC LABORATORY

Report No. TL13-320

30 May

2:25

Page 2 of 2

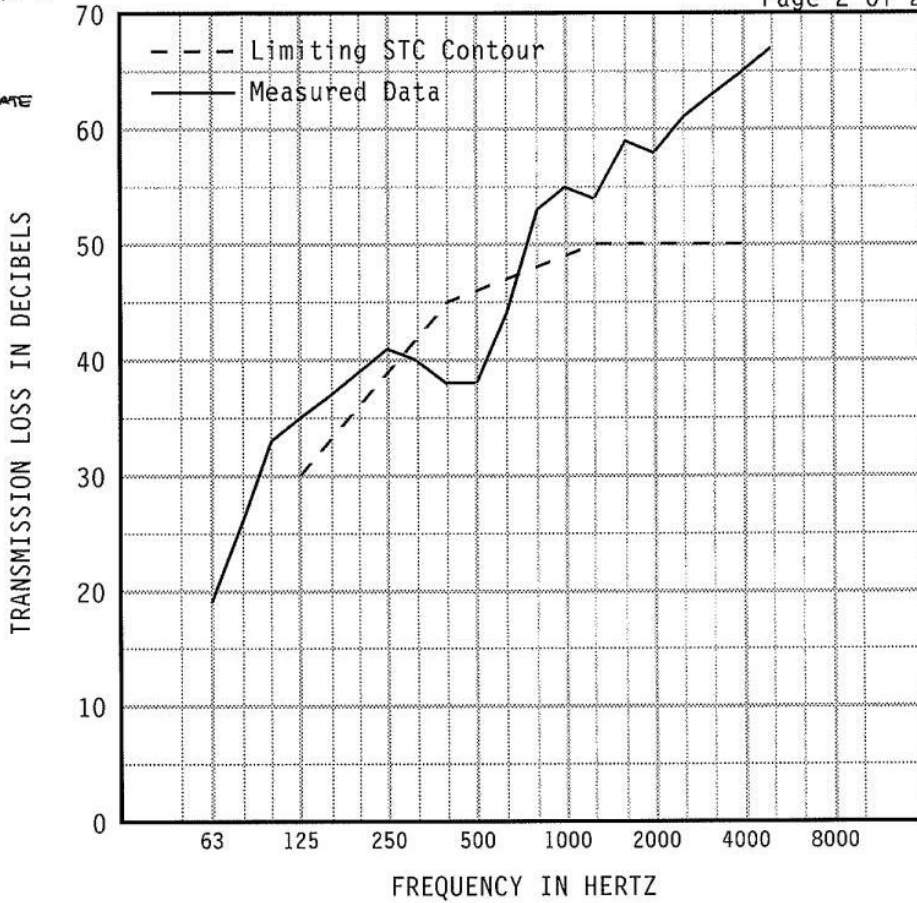

1/3 OCT BND CNTR FREQ	63	80	100	125	160	200	250	315	400	500
TL in dB	*19	*26	*33	*35	*37	*39	*41	*40	38	38
95% Confidence in dB deficiencies	1.42	1.92	2.07	1.47	0.89	0.76	0.80	0.52 (2)	0.36 (7)	0.38 (8)
1/3 OCT BND CNTR FREQ	630	800	1000	1250	1600	2000	2500	3150	4000	5000
TL in dB	44	*53	*55	54	*59	*58	*61	*63	*65	*67
95% Confidence in dB deficiencies	0.29	0.44	0.38	0.39	0.36	0.56	0.55	0.31	0.32	0.50
	(3)									

EWR	OITC
48	40

* Minimum estimate of transmission loss. Measurement limited by filler wall. Actual TL will be equal to or greater than value reported.

Specimen Area: 2.81 sq.ft.
 Temperature: 74.7 deg. F
 Relative Humidity: 42 %
 Test Date: 30 May 2013

STC
46 (20)

Report must be distributed in its entirety except with written authorization from Western Electro-Acoustic Laboratory

CLASS C
NO FILL

OVERCLAD: GYP+MLV

WESTERN ELECTRO-ACOUSTIC LABORATORY

Report No. TL13-321

30 MAY 2013
3:30pm

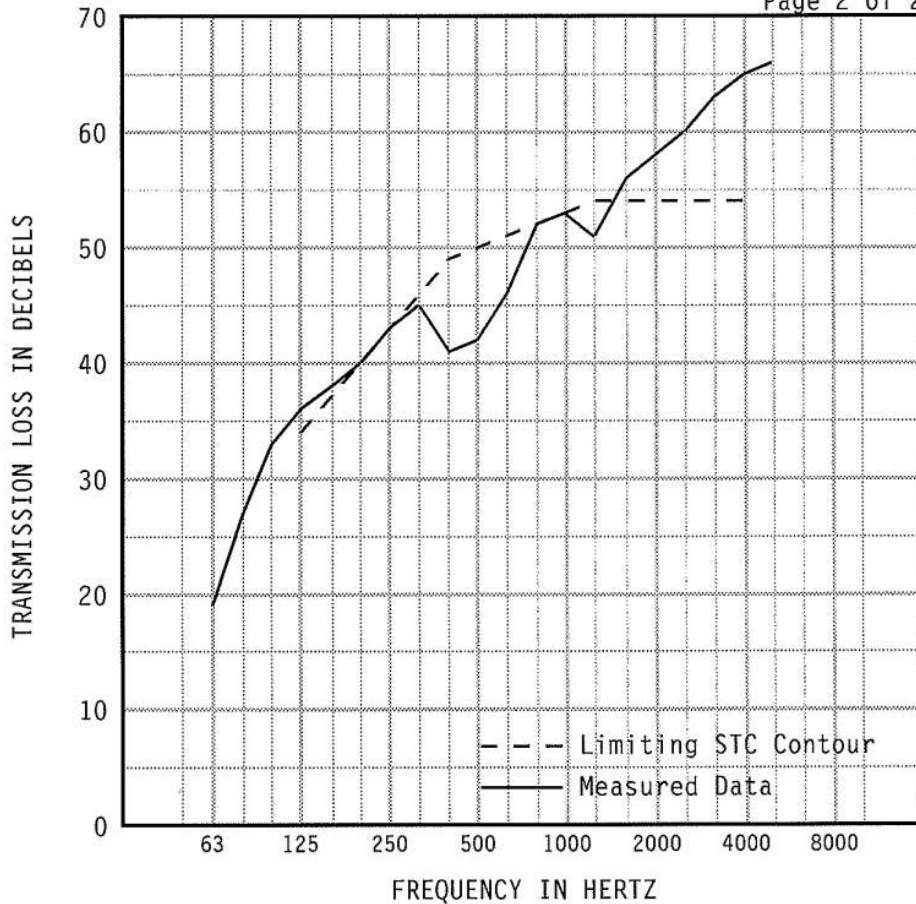

1/3 OCT BND CNTR FREQ	63	80	100	125	160	200	250	315	400	500
TL in dB	*19	*27	*33	*36	*38	*40	*43	*45	41	42
95% Confidence in dB deficiencies	1.42	1.92	2.07	1.47	0.89	0.76 (0)	0.80 (0)	0.52 (1)	0.36 (8)	0.38 (8)
1/3 OCT BND CNTR FREQ	630	800	1000	1250	1600	2000	2500	3150	4000	5000
TL in dB	46	*52	53	51	*56	*58	*60	*63	*65	*66
95% Confidence in dB deficiencies	0.29 (5)	0.44 (0)	0.38 (0)	0.39 (3)	0.36	0.56	0.55	0.31	0.32	0.50

EWR	OITC	* Minimum estimate of transmission loss. Measurement limited by filler wall. Actual TL will be equal to or greater than value reported.	Specimen Area: 2.81 sq.ft. Temperature: 74.8 deg. F Relative Humidity: 46 % Test Date: 30 May 2013	STC
50	42			50
				(25)

Report must be distributed in its entirety except with written authorization from Western Electro-Acoustic Laboratory

2400 C

FILL: MLV PILLOWS

WESTERN ELECTRO-ACOUSTIC LABORATORY

Report No. TL13-323

MAY 30, 2013

5:28pm

OVERCLAD:
MLV+GYP

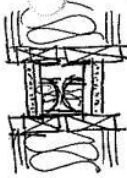

Page 2 of 2

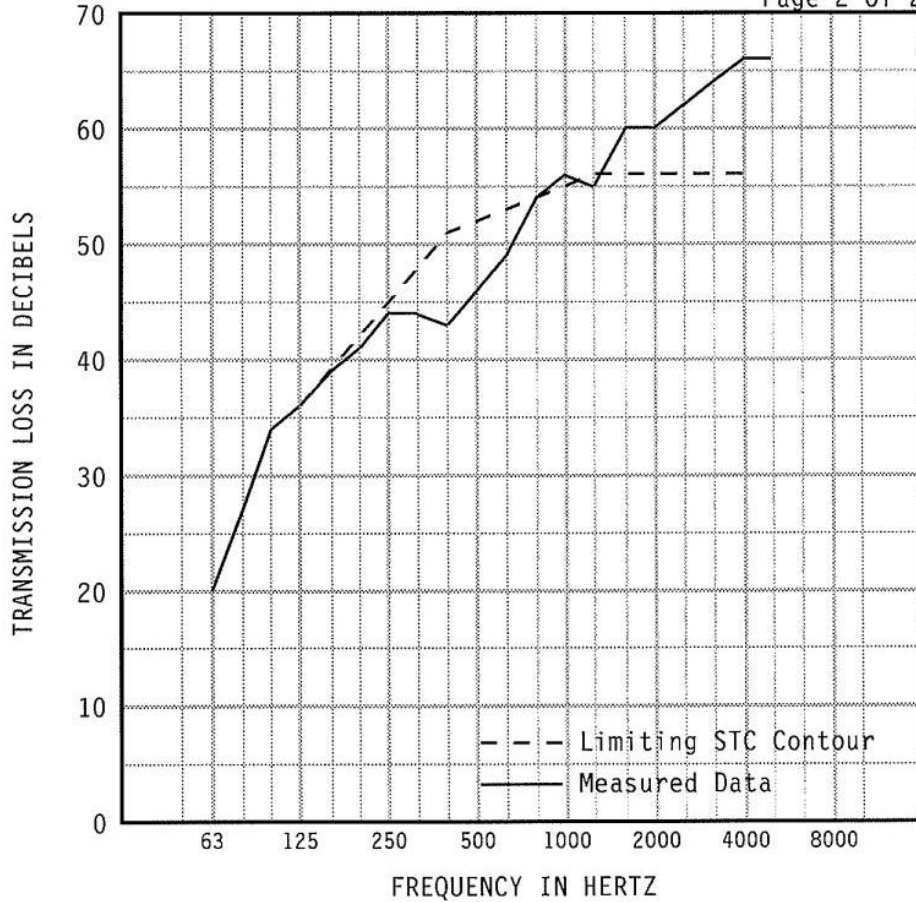

1/3 OCT BND CNTR FREQ	63	80	100	125	160	200	250	315	400	500
TL in dB	*20	*27	*34	*36	*39	*41	*44	*44	*43	*46
95% Confidence in dB deficiencies	1.42	1.92	2.07	1.47	0.89	0.76	0.80	0.52	0.36	0.38
				(0)	(0)	(1)	(1)	(4)	(8)	(6)
1/3 OCT BND CNTR FREQ	630	800	1000	1250	1600	2000	2500	3150	4000	5000
TL in dB	*49	*54	*56	*55	*60	*60	*62	*64	*66	*66
95% Confidence in dB deficiencies	0.29	0.44	0.38	0.39	0.36	0.56	0.55	0.31	0.32	0.50
	(4)	(0)		(1)						

EWR	OITC	* Minimum estimate of transmission loss. Measurement limited by filler wall. Actual TL will be equal to or greater than value reported.	Specimen Area: 2.81 sq.ft. Temperature: 75.2 deg. F Relative Humidity: 44 % Test Date: 30 May 2013	STC
52	43			52 (25)

Report must be distributed in its entirety except with written authorization from Western Electro-Acoustic Laboratory

CLASS C
 FILL: MLV PILLOWS
 OVERCLAD: GYPBOARD

WESTERN ELECTRO-ACOUSTIC LABORATORY
 Report No. TL13-324

30 May
 6:10 pm

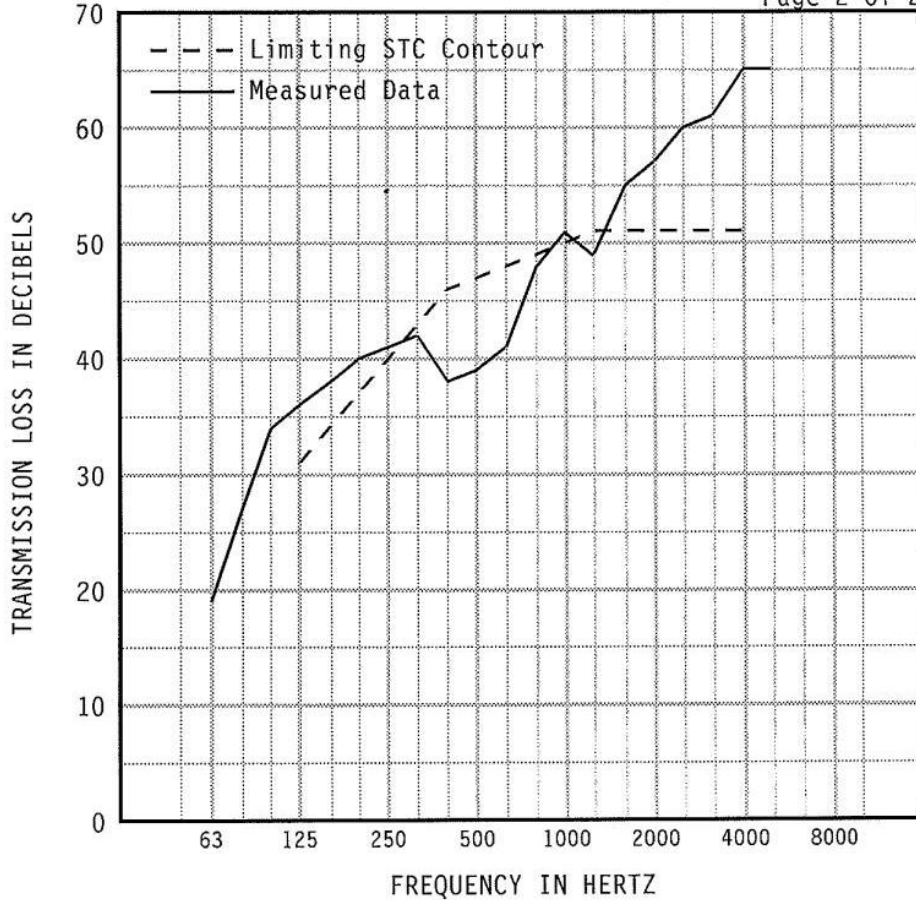

1/3 OCT BND CNTR FREQ	63	80	100	125	160	200	250	315	400	500
TL in dB	*19	*27	*34	*36	*38	*40	*41	*42	38	39
95% Confidence in dB deficiencies	1.42	1.92	2.07	1.47	0.89	0.76	0.80	0.52 (1)	0.36 (8)	0.38 (8)
1/3 OCT BND CNTR FREQ	630	800	1000	1250	1600	2000	2500	3150	4000	5000
TL in dB	41	48	51	49	55	*57	*60	*61	*65	*65
95% Confidence in dB deficiencies	0.29 (7)	0.44 (1)	0.38	0.39 (2)	0.36	0.56	0.55	0.31	0.32	0.50

EWR	OITC	* Minimum estimate of transmission loss. Measurement limited by filler wall. Actual TL will be equal to or greater than value reported. Specimen Area: 2.81 sq.ft. Temperature: 75.2 deg. F Relative Humidity: 44 % Test Date: 30 May 2013	STC
48	41		47 (27)

Report must be distributed in its entirety except with written authorization from Western Electro-Acoustic Laboratory

overdad: gypbd
no fill

WESTERN ELECTRO-ACOUSTIC LABORATORY
Report No. TL13-325

31 MAY 2013
7:30am

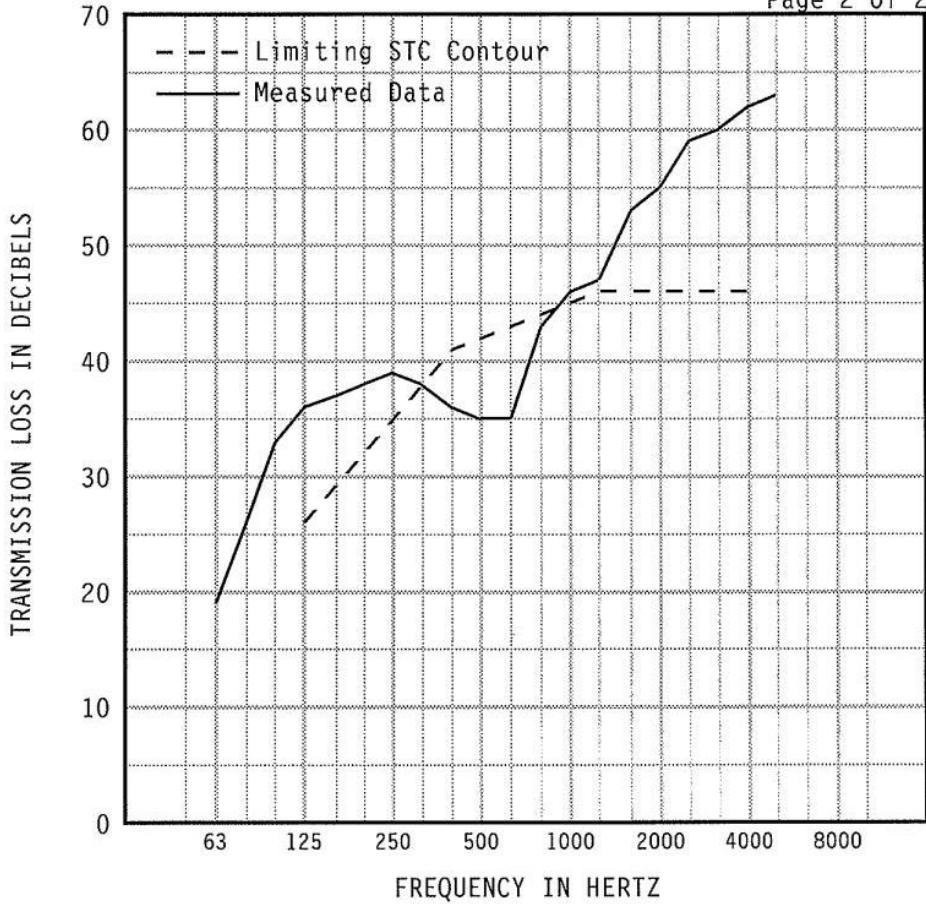

1/3 OCT BND CNTR FREQ	63	80	100	125	160	200	250	315	400	500
TL in dB	*19	*26	*33	*36	*37	*38	*39	38	36	35
95% Confidence in dB deficiencies	1.42	1.92	2.07	1.47	0.89	0.76	0.80	0.52 (0)	0.36 (5)	0.38 (7)
1/3 OCT BND CNTR FREQ	630	800	1000	1250	1600	2000	2500	3150	4000	5000
TL in dB	35	43	46	47	53	*55	*59	*60	*62	*63
95% Confidence in dB deficiencies	0.29 (8)	0.44 (1)	0.38	0.39	0.36	0.56	0.55	0.31	0.32	0.50

EWR	OITC	* Minimum estimate of transmission loss. Measurement limited by filler wall. Actual TL will be equal to or greater than value reported. Specimen Area: 2.81 sq.ft. Temperature: 74.1 deg. F Relative Humidity: 44 % Test Date: 31 May 2013	STC
45	38		42 (21)

Report must be distributed in its entirety except with written authorization from Western Electro-Acoustic Laboratory

WESTERN ELECTRO-ACOUSTIC LABORATORY

Report No. TL13-326

Pea
Gravel
61.5 lb

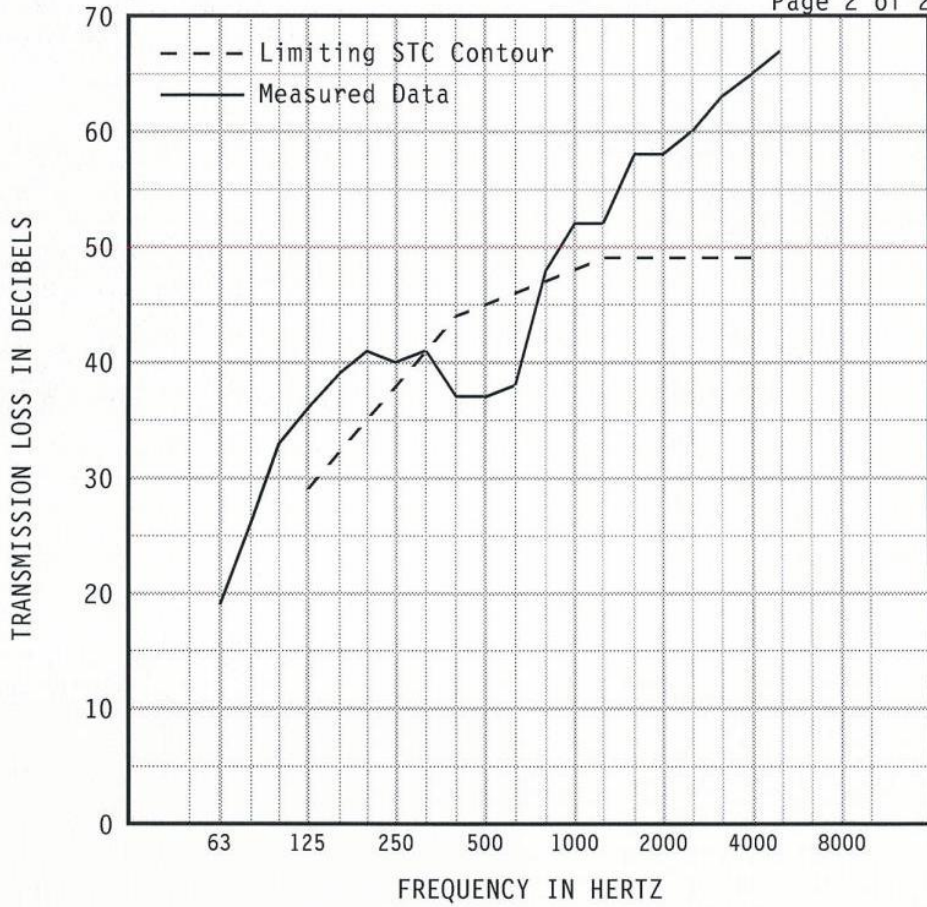

1/3 OCT BND CNTR	FREQ	63	80	100	125	160	200	250	315	400	500
TL in dB		*19	*26	*33	*36	*39	*41	*40	*41	37	37
95% Confidence in dB deficiencies		1.42	1.92	2.07	1.47	0.89	0.76	0.80	0.52 (0)	0.36 (7)	0.38 (8)
1/3 OCT BND CNTR	FREQ	630	800	1000	1250	1600	2000	2500	3150	4000	5000
TL in dB		38	48	52	52	*58	*58	*60	*63	*65	*67
95% Confidence in dB deficiencies		0.29 (8)	0.44	0.38	0.39	0.36	0.56	0.55	0.31	0.32	0.50

EWR	OITC	* Minimum estimate of transmission loss. Measurement limited by filler wall. Actual TL will be equal to or greater than value reported.	Specimen Area: 2.81 sq.ft. Temperature: 74.7 deg. F Relative Humidity: 44 % Test Date: 31 May 2013	STC
47	40			45 (23)

Report must be distributed in its entirety except with written authorization from Western Electro-Acoustic Laboratory

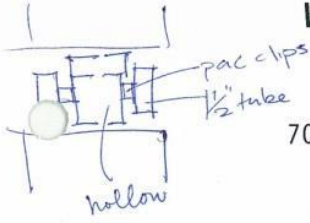

WESTERN ELECTRO-ACOUSTIC LABORATORY

Report No. TL13-327

around noon
31 May 2013

Page 2 of 2

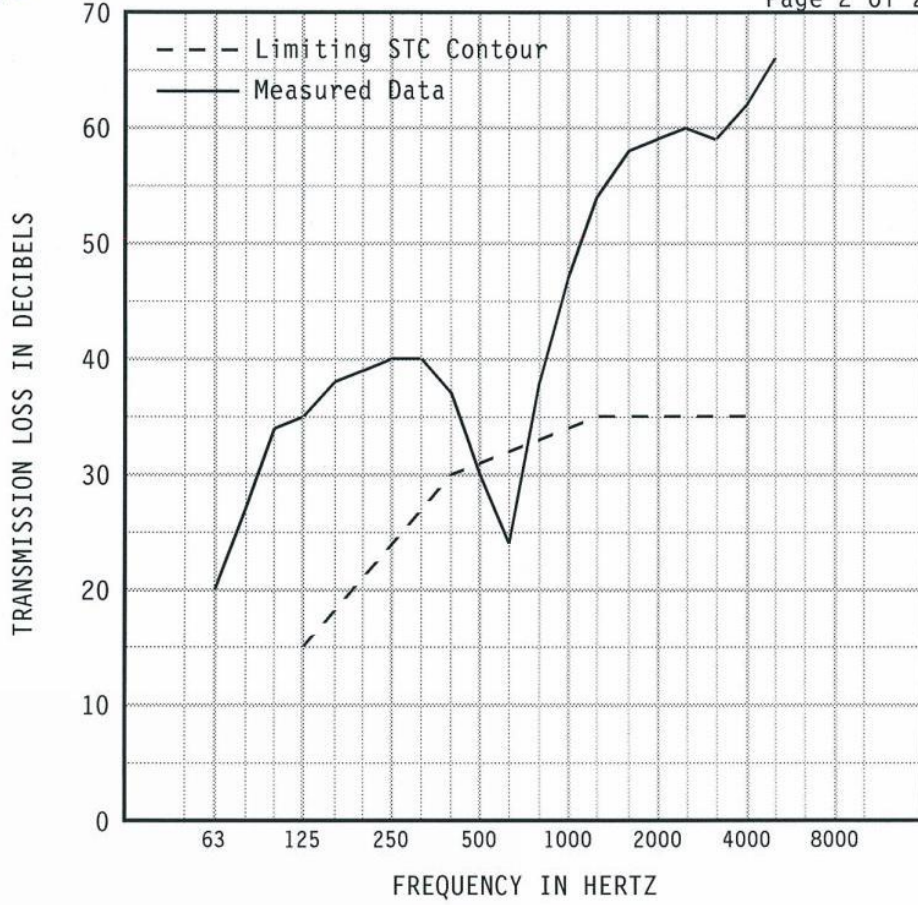

1/3 OCT BND CNTR	FREQ	63	80	100	125	160	200	250	315	400	500
TL in dB		*20	*27	*34	*35	*38	*39	*40	40	37	30
95% Confidence in dB deficiencies		1.42	1.92	2.07	1.47	0.89	0.76	0.80	0.52	0.36	0.38 (1)
1/3 OCT BND CNTR	FREQ	630	800	1000	1250	1600	2000	2500	3150	4000	5000
TL in dB		24	38	47	54	*58	*59	*60	*59	*62	*66
95% Confidence in dB deficiencies		0.29 (8)	0.44	0.38	0.39	0.36	0.56	0.55	0.31	0.32	0.50

EWR	OITC	* Minimum estimate of transmission loss. Measurement limited by filler wall. Actual TL will be equal to or greater than value reported.	Specimen Area: 2.81 sq.ft.	STC 31 (9)
40	33		Temperature: 75.4 deg. F	
			Relative Humidity: 46 %	
			Test Date: 31 May 2013	

Report must be distributed in its entirety except with written authorization from Western Electro-Acoustic Laboratory

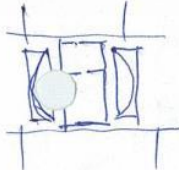

WESTERN ELECTRO-ACOUSTIC LABORATORY

Report No. TL13-328

4:00p

31 MAY

Page 2 of 2

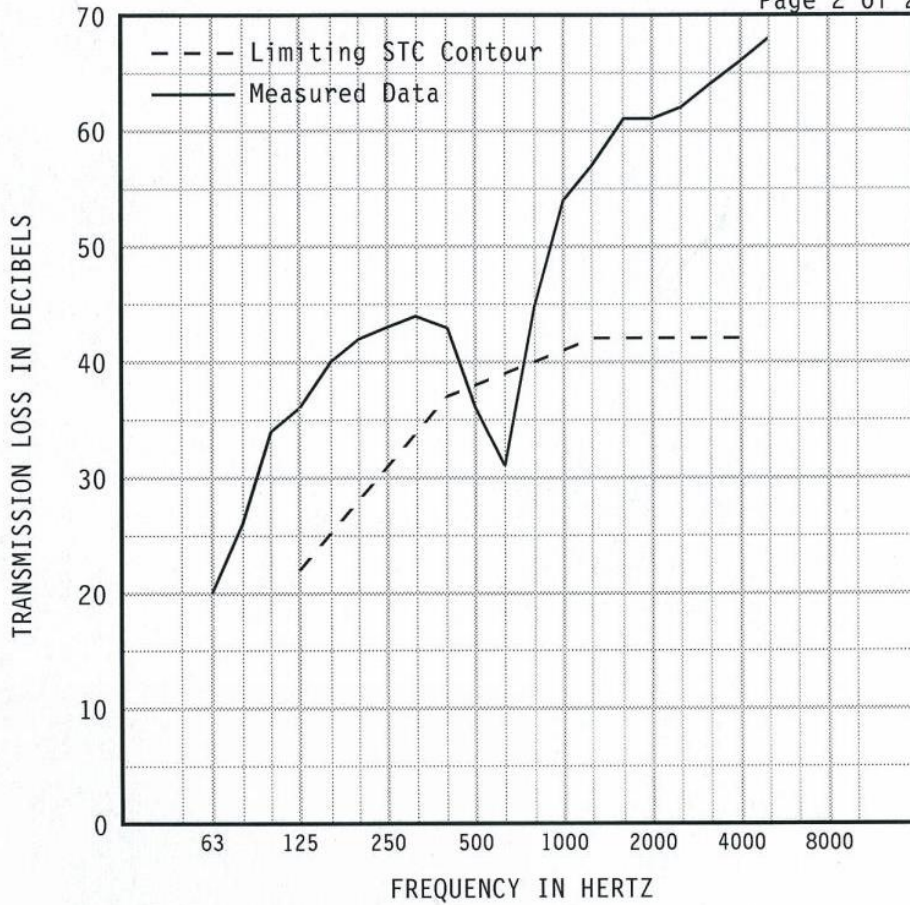

1/3 OCT BND CNTR FREQ	63	80	100	125	160	200	250	315	400	500
TL in dB	*20	*26	*34	*36	*40	*42	*43	*44	*43	36
95% Confidence in dB deficiencies	1.42	1.92	2.07	1.47	0.89	0.76	0.80	0.52	0.36	0.38 (2)
1/3 OCT BND CNTR FREQ	630	800	1000	1250	1600	2000	2500	3150	4000	5000
TL in dB	31	45	*54	*57	*61	*61	*62	*64	*66	*68
95% Confidence in dB deficiencies	0.29	0.44	0.38	0.39	0.36	0.56	0.55	0.31	0.32	0.50

EWR	OITC	* Minimum estimate of transmission loss. Measurement limited by filler wall. Actual TL will be equal to or greater than value reported.	Specimen Area: 2.81 sq.ft.	STC 38 (10)
47	38		Temperature: 75.7 deg. F	
			Relative Humidity: 55 %	
			Test Date: 31 May 2013	

Report must be distributed in its entirety except with written authorization from Western Electro-Acoustic Laboratory

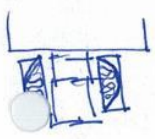

WESTERN ELECTRO-ACOUSTIC LABORATORY

Report No. TL13-329

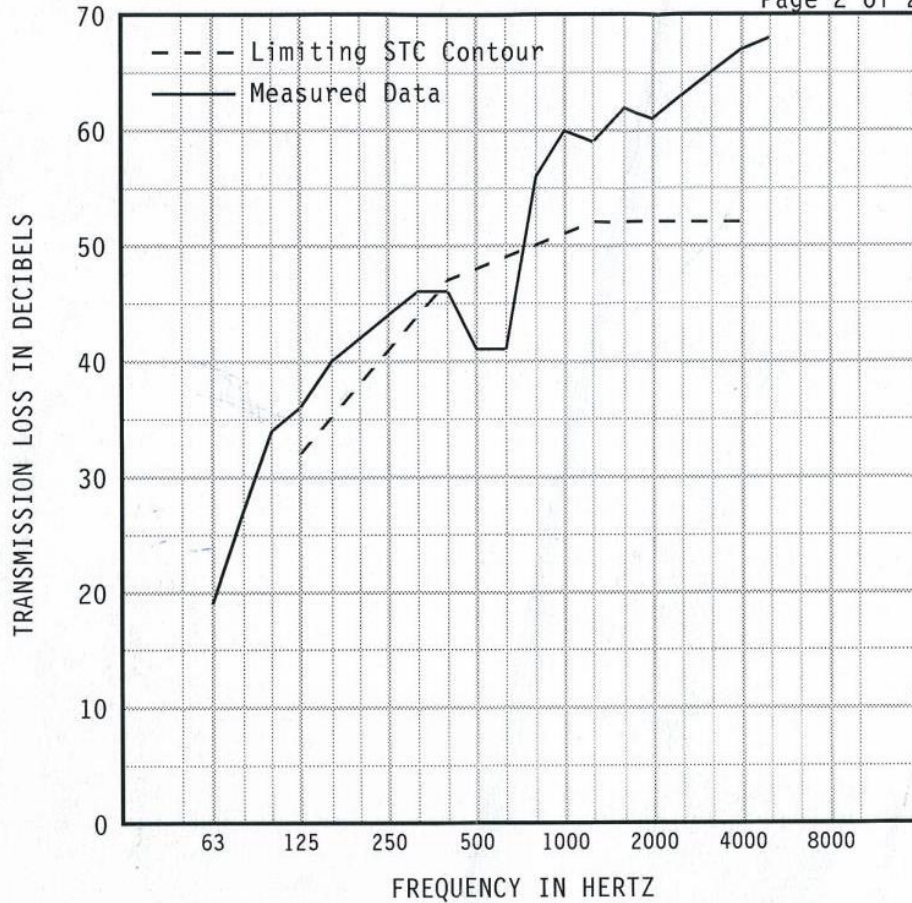

1/3 OCT BND CNTR FREQ	63	80	100	125	160	200	250	315	400	500
TL in dB	*19	*27	*34	*36	*40	*42	*44	*46	*46	41
95% Confidence in dB deficiencies	1.42	1.92	2.07	1.47	0.89	0.76	0.80	0.52	0.36 (1)	0.38 (7)
1/3 OCT BND CNTR FREQ	630	800	1000	1250	1600	2000	2500	3150	4000	5000
TL in dB	41	*56	*60	*59	*62	*61	*63	*65	*67	*68
95% Confidence in dB deficiencies	0.29 (8)	0.44	0.38	0.39	0.36	0.56	0.55	0.31	0.32	0.50

EWR	OITC	* Minimum estimate of transmission loss. Measurement limited by filler wall. Actual TL will be equal to or greater than value reported.	Specimen Area: 2.81 sq.ft.	STC
51	42		Temperature: 75.9 deg. F	48
			Relative Humidity: 57 %	(16)
			Test Date: 31 May 2013	

Report must be distributed in its entirety except with written authorization from Western Electro-Acoustic Laboratory

WESTERN ELECTRO-ACOUSTIC LABORATORY

7:50pm

Report No. TL13-330

Page 2 of 2

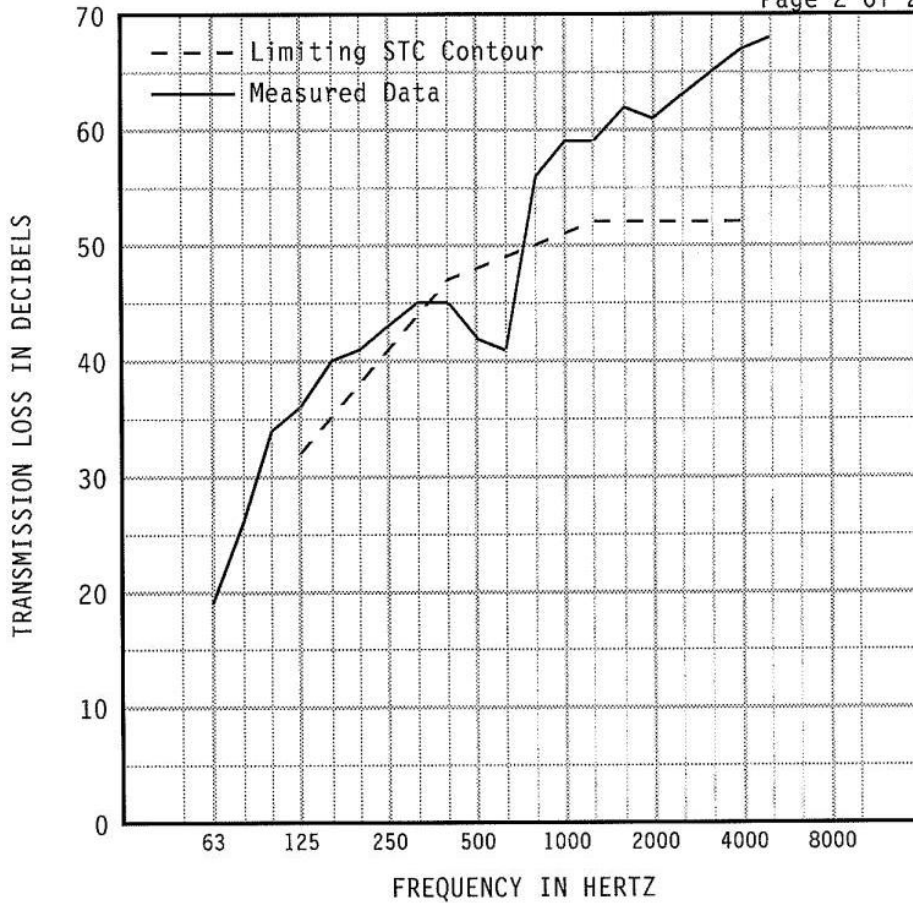

1/3 OCT BND CNTR FREQ	63	80	100	125	160	200	250	315	400	500
TL in dB	*19	*26	*34	*36	*40	*41	*43	*45	*45	42
95% Confidence in dB deficiencies	1.42	1.92	2.07	1.47	0.89	0.76	0.80	0.52	0.36 (2)	0.38 (6)
1/3 OCT BND CNTR FREQ	630	800	1000	1250	1600	2000	2500	3150	4000	5000
TL in dB	41	*56	*59	*59	*62	*61	*63	*65	*67	*68
95% Confidence in dB deficiencies	0.29 (8)	0.44	0.38	0.39	0.36	0.56	0.55	0.31	0.32	0.50

EWR	OITC	* Minimum estimate of transmission loss. Measurement limited by filler wall. Actual TL will be equal to or greater than value reported.	Specimen Area: 2.81 sq.ft.	STC
50	42		Temperature: 76.1 deg. F	
			Relative Humidity: 52 %	
			Test Date: 31 May 2013	
				48 (16)

Report must be distributed in its entirety except with written authorization from Western Electro-Acoustic Laboratory

B.3 PHASE 2A WEAL TEST RESULTS

The area of the filler wall aperture varied for certain test specimens. Final transmission loss test results were corrected after the phase was complete (Table B-2).

Test Number	Area (SF)	STC	mullion fill	overclad	connection	edge seal
TL13-398	2.81	42	none	1-1/2" alum tube with MLV isolators, filled w MLV pillows	none	1/2" perimeter, putty
TL13-399	2.81	36	none	none	none	1/2" perimeter, putty
TL13-400	2.81	42	TL-402 air leaks			
TL13-401	2.81	46	TL-402 air leaks			
TL13-402	2.81	49	MLV Pillows	5/8" gypsum board + MLV plate, screwed to mullion	none	1/2" perimeter, putty
TL13-404	2.81	35	ram packed mineral fiber	none	none	1/2" perimeter, putty
TL13-405	3.02	44	MLV Pillows	5/8" gypsum board + MLV plate, screwed to mullion	1/2" Armacell,	3 edges 1/4" putty, 1/4" wood shim for compression on 1/2" armacell
TL13-406	3.13	52	MLV Pillows	5/8" gypsum board + MLV plate, screwed to mullion	3/4" backer rod with caulking	3/4" wet seal, 3 edges 1/4" putty, 1/4" neoprene shim
TL13-407	3.13	34	none	none	3/4" backer rod with caulking	all 4 edges wet seal, incl 3/4" edge, 1/4" neoprene shim
TL13-408	3.13	38	none	none	3/4" backer rod with caulking	3/4" wet seal, other 3 edges wet seal + masking tape + putty, neoprene shim
TL13-409	3.13	49	TL-411 flagged			
TL13-410	3.13	49	TL-411 flagged			
TL13-411	3.13	49	MLV pillows	1-1/2" alum tube with PAC isolators, filled w MLV pillows	3/4" backer rod with caulking	all 4 edge wet seal, incl 3/4" edge, 1/4" neoprene shim
TL13-412	3.75	31	MLV Pillows	5/8" gypsum board + MLV plate, screwed to mullion	source side, (1) 2-1/2" width silicone strip compressed 1/4"	wet seal top and bottom of silicone, 3 edges 1/4" putty, 1/4" neoprene shim
TL13-413	3.75	41	MLV Pillows	5/8" gypsum board + MLV plate, screwed to mullion	both sides, (2) 2-1/2" width silicone strip compressed 1/4"	wet seal top and bottom of silicone, 3 edges 1/4" putty, 1/4" neoprene shim
TL13-414	3.75	32	MLV Pillows	5/8" gypsum board + MLV plate, screwed to mullion	receiver side, (1) 2-1/2" width silicone strip compressed 1/4"	wet seal top and bottom of silicone, 3 edges 1/4" putty, 1/4" neoprene shim

Test Number	Area (SF)	STC	mullion fill	overclad	connection	edge seal
TL13-415	3.75	36	MLV Pillows	5/8" gypsum board + MLV plate, screwed to mullion	source side, (1) 2-1/2" width silicone strip compressed 1/4", metal overclad adhered with masking tape	wet seal top and bottom of silicone, 3 edges 1/4" putty, 1/4" neoprene shim, wet seal on one edge of metal plate
TL13-416	3.75	34	MLV Pillows	5/8" gypsum board + MLV plate, screwed to mullion	both sides (2) 2-1/2" width silicone strip compressed 1/4", metal overclad adhered with masking tape	wet seal top and bottom of silicone, 3 edges 1/4" putty, 1/4" neoprene shim, wet seal on one edge of metal plate
TL13-417	3.75	30	none	none	source side, (1) 2-1/2" width silicone strip compressed 1/4"	wet seal top and bottom of silicone, 3 edges 1/4" putty, 1/4" neoprene shim
TL13-418	3.75	35	none	none	both sides, (2) 2-1/2" width silicone strip compressed 1/4"	wet seal top and bottom of silicone, 3 edges 1/4" putty, 1/4" neoprene shim
TL13-419	2.81	28	none	none	both sides (2) 2-1/2" width silicone strip compressed 1/4", metal overclad adhered with masking tape	wet seal top and bottom of silicone, 3 edges 1/4" putty, 1/4" neoprene shim, wet seal on one edge of metal plate
TL13-420	3.75	31	none	none	both sides (2) 2-1/2" width silicone strip compressed 1/4", metal overclad adhered with masking tape	wet seal top and bottom of silicone, 3 edges 1/4" putty, 1/4" neoprene shim, wet seal on one edge of metal plate
TL13-421	3.75	34	none	none	source side, (1) 2-1/2" width silicone strip compressed 1/4", metal overclad adhered with masking tape	wet seal top and bottom of silicone, 3 edges 1/4" putty, 1/4" neoprene shim, wet seal on one edge of metal plate
TL13-422	3.75	22	none	none	none , metal overclad adhered with masking tape	3 edges 1/4" putty, 1/4" neoprene shim, wet seal on one edge of metal plate
TL13-423	3.125	46	none	none	mull-it-over	bare mullion: putty on 3 sides, 1/2" backer rod +wet seal on one side mullitover: putty on top and bottom, wet seal on screws, compression seal on one side

TABLE B- 3: PHASE 2A, WEAL TEST NUMBERS, AREA AND DESCRIPTION

WESTERN ELECTRO-ACOUSTIC LABORATORY

Report No. TL13-398

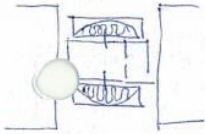

HOLLOW MULLION
 1/2" TUBE OVERCLAD
 + FILLED W/ MLV + FG

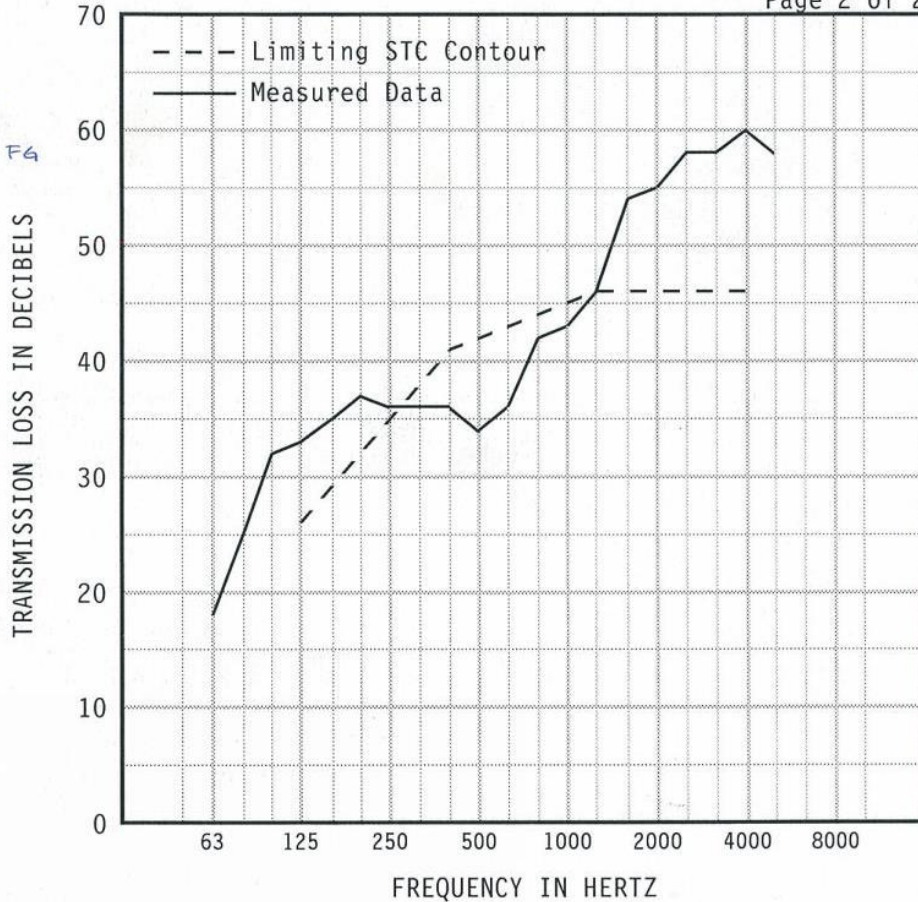

1/3 OCT BND CNTR FREQ	63	80	100	125	160	200	250	315	400	500
TL in dB	*18	*25	*32	*33	*35	*37	36	36	36	34
95% Confidence in dB deficiencies	1.42	1.92	2.07	1.47	0.89	0.76	0.80	0.52 (2)	0.36 (5)	0.38 (8)
1/3 OCT BND CNTR FREQ	630	800	1000	1250	1600	2000	2500	3150	4000	5000
TL in dB	36	42	43	46	54	*55	*58	*58	*60	58
95% Confidence in dB deficiencies	0.29 (7)	0.44 (2)	0.38 (2)	0.39 (0)	0.36	0.56	0.55	0.31	0.32	0.50

EWR	OITC
43	37

* Minimum estimate of transmission loss. Measurement limited by filler wall. Actual TL will be equal to or greater than value reported.

Specimen Area: 2.81 sq. ft.
 Temperature: 74.8 deg. F
 Relative Humidity: 33 %
 Test Date: 17 July 2013

STC
42 (26)

Report must be distributed in its entirety except with written authorization from Western Electro-Acoustic Laboratory

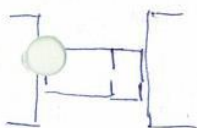

BARE +
 Hollow
 mullion
 putty

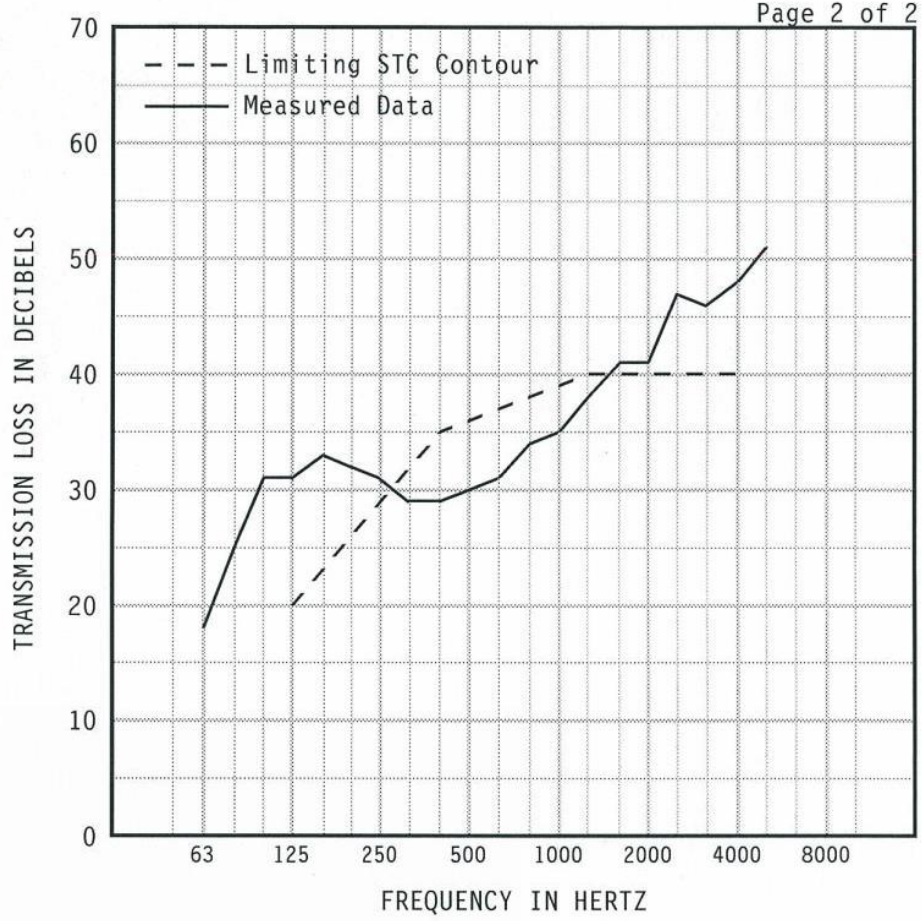

1/3 OCT BND CNTR FREQ	63	80	100	125	160	200	250	315	400	500
TL in dB	*18	*25	*31	*31	*33	32	31	29	29	30
95% Confidence in dB deficiencies	1.42	1.92	2.07	1.47	0.89	0.76	0.80	0.52 (3)	0.36 (6)	0.38 (6)
1/3 OCT BND CNTR FREQ	630	800	1000	1250	1600	2000	2500	3150	4000	5000
TL in dB	31	34	35	38	41	41	47	46	48	51
95% Confidence in dB deficiencies	0.29 (6)	0.44 (4)	0.38 (4)	0.39 (2)	0.36	0.56	0.55	0.31	0.32	0.50

EWR	OITC	* Minimum estimate of transmission loss. Measurement limited by filler wall. Actual TL will be equal to or greater than value reported. Specimen Area: 2.81 sq.ft. Temperature: 76.6 deg. F Relative Humidity: 33 % Test Date: 17 July 2013	STC
37	33		36
			(31)

Report must be distributed in its entirety except with written authorization from Western Electro-Acoustic Laboratory

WESTERN ELECTRO-ACOUSTIC LABORATORY

Report No. TL13-400

11/1/13

Page 2 of 2

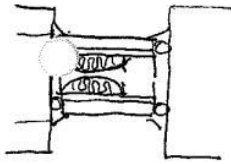

MULLION: MLV PILLOW
OVERCLAD: MLV + GYPBD

*TOO MANY
LEAKS
(REDO)

TRANSMISSION LOSS IN DECIBELS

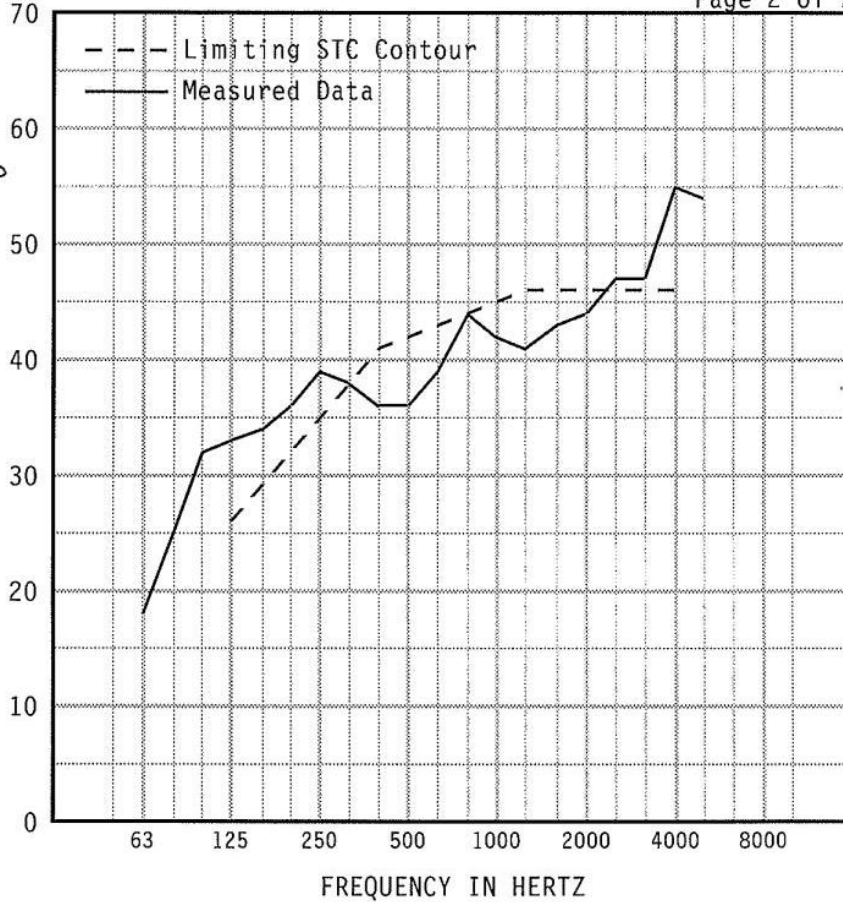

1/3 OCT BND CNTR FREQ	63	80	100	125	160	200	250	315	400	500
TL in dB	*18	*25	*32	*33	*34	*36	*39	38	36	36
95% Confidence in dB deficiencies	1.42	1.92	2.07	1.47	0.89	0.76	0.80	0.52 (0)	0.36 (5)	0.38 (6)
1/3 OCT BND CNTR FREQ	630	800	1000	1250	1600	2000	2500	3150	4000	5000
TL in dB	39	44	42	41	43	44	47	47	55	54
95% Confidence in dB deficiencies	0.29 (4)	0.44 (0)	0.38 (3)	0.39 (5)	0.36 (3)	0.56 (2)	0.55	0.31	0.32	0.50

EWR	OITC
44	38

* Minimum estimate of transmission loss. Measurement limited by filler wall. Actual TL will be equal to or greater than value reported.

Specimen Area: 2.81 sq.ft.
Temperature: 77.4 deg. F
Relative Humidity: 32 %
Test Date: 17 July 2013

STC
42 (28)

Report must be distributed in its entirety except with written authorization from Western Electro-Acoustic Laboratory

7/17/2013

WESTERN ELECTRO-ACOUSTIC LABORATORY

Report No. TL13-401

* SAME AS
TL13-400
(5 TOO
MANY LEAKS)

Page 2 of 2

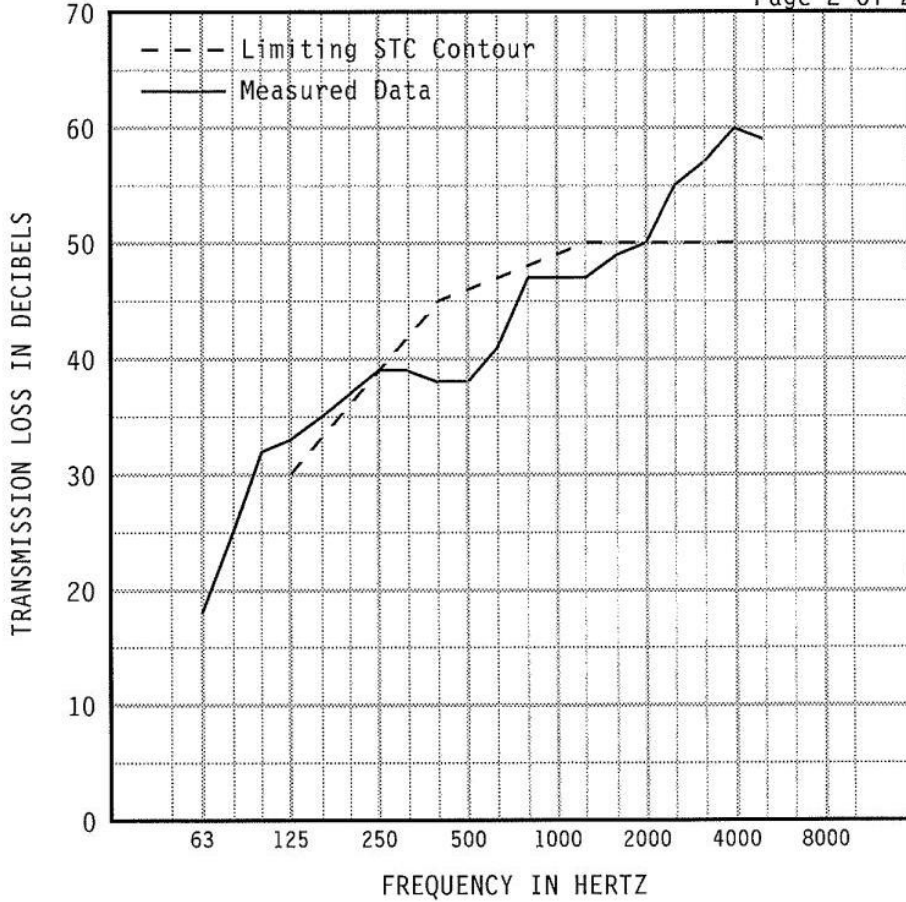

1/3 OCT BND CNTR FREQ	63	80	100	125	160	200	250	315	400	500
TL in dB	*18	*25	*32	*33	*35	*37	*39	39	38	38
95% Confidence in dB deficiencies	1.42	1.92	2.07	1.47	0.89	0.76	0.80 (0)	0.52 (3)	0.36 (7)	0.38 (8)
1/3 OCT BND CNTR FREQ	630	800	1000	1250	1600	2000	2500	3150	4000	5000
TL in dB	41	47	47	47	49	50	*55	57	*60	59
95% Confidence in dB deficiencies	0.29 (6)	0.44 (1)	0.38 (2)	0.39 (3)	0.36 (1)	0.56 (0)	0.55	0.31	0.32	0.50

EWR	OITC	* Minimum estimate of transmission loss. Measurement limited by filler wall. Actual TL will be equal to or greater than value reported.	Specimen Area: 2.81 sq.ft. Temperature: 77.4 deg. F Relative Humidity: 33 % Test Date: 17 July 2013	STC
46	39			46 (31)

Report must be distributed in its entirety except with written authorization from Western Electro-Acoustic Laboratory

7/17/13

WESTERN ELECTRO-ACOUSTIC LABORATORY

Report No. TL13-402

X SAME AS
-400
-401

BE WE CAN DO
DUE TO 1/2" GAP
ON EITHER SIDE

PREVIOUSLY
TL13-323
ONLY 1/4" GAP

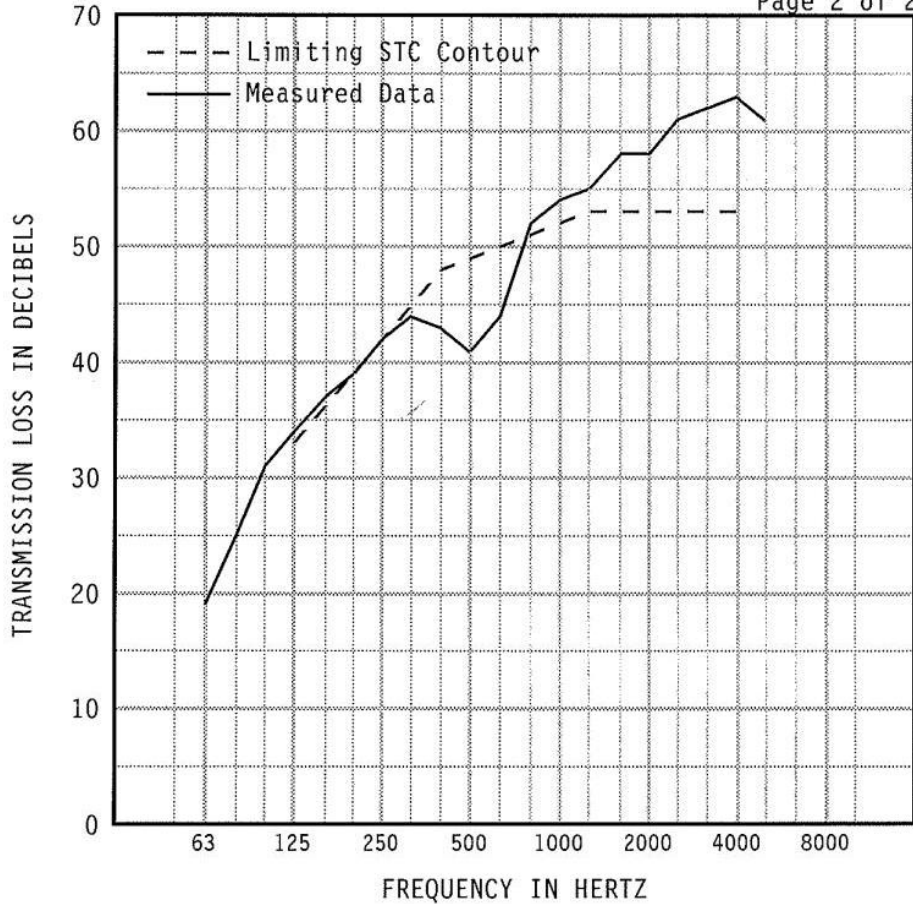

1/3 OCT BND CNTR FREQ	63	80	100	125	160	200	250	315	400	500
TL in dB	*19	*25	*31	*34	*37	*39	*42	*44	*43	41
95% Confidence in dB deficiencies	1.42	1.92	2.07	1.47	0.89	0.76 (0)	0.80 (0)	0.52 (1)	0.36 (5)	0.38 (8)
1/3 OCT BND CNTR FREQ	630	800	1000	1250	1600	2000	2500	3150	4000	5000
TL in dB	44	*52	*54	*55	*58	*58	*61	*62	*63	*61
95% Confidence in dB deficiencies	0.29 (6)	0.44	0.38	0.39	0.36	0.56	0.55	0.31	0.32	0.50

EWR	OITC	* Minimum estimate of transmission loss. Measurement limited by filler wall. Actual TL will be equal to or greater than value reported.	Specimen Area: 2.81 sq.ft. Temperature: 77.4 deg. F Relative Humidity: 33 % Test Date: 17 July 2013	STC
49	41			49 (20)

Report must be distributed in its entirety except with written authorization from Western Electro-Acoustic Laboratory

WESTERN ELECTRO-ACOUSTIC LABORATORY

Report No. TL13-404

11/11/13

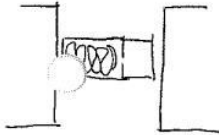

RAM PACKED
MIN. WOOL

Page 2 of 2

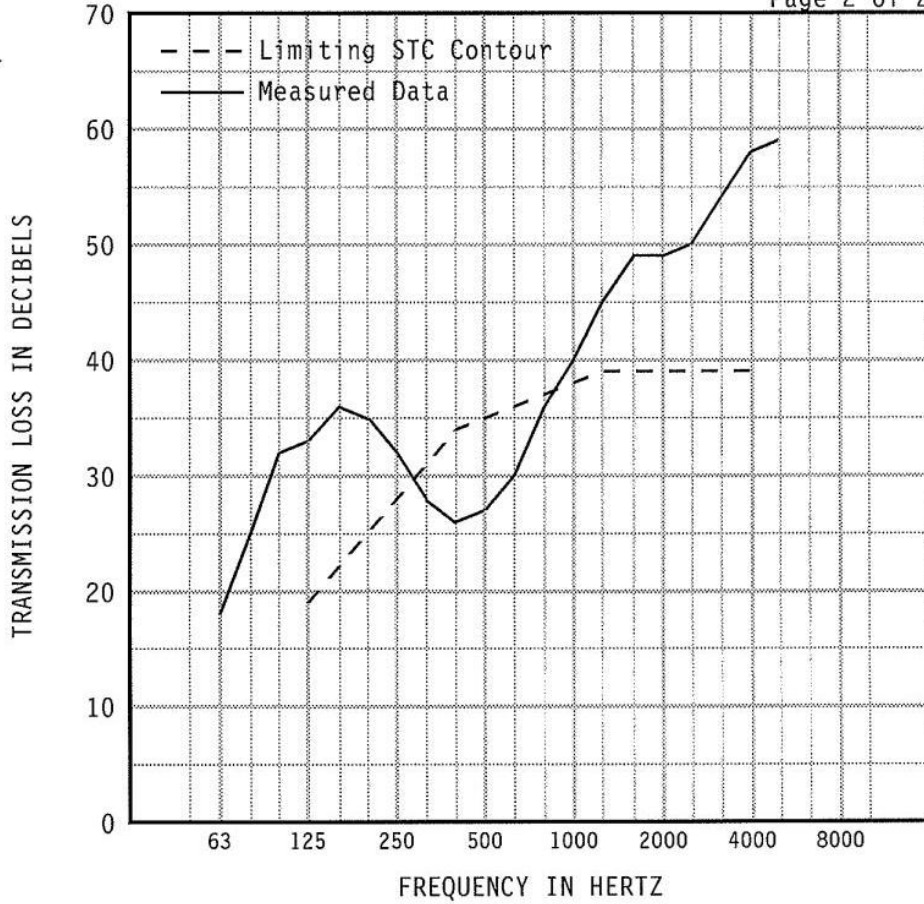

1/3 OCT BND CNTR FREQ	63	80	100	125	160	200	250	315	400	500
TL in dB	*18	*25	*32	*33	*36	35	32	28	26	27
95% Confidence in dB deficiencies	1.42	1.92	2.07	1.47	0.89	0.76	0.80	0.52 (3)	0.36 (8)	0.38 (8)
1/3 OCT BND CNTR FREQ	630	800	1000	1250	1600	2000	2500	3150	4000	5000
TL in dB	30	36	40	45	49	49	50	54	58	59
95% Confidence in dB deficiencies	0.29 (6)	0.44 (1)	0.38	0.39	0.36	0.56	0.55	0.31	0.32	0.50

EWR	OITC	* Minimum estimate of transmission loss. Measurement limited by filler wall. Actual TL will be equal to or greater than value reported. Specimen Area: 2.81 sq.ft. Temperature: 77.5 deg. F Relative Humidity: 33 % Test Date: 17 July 2013	STC
37	32		35 (26)

Report must be distributed in its entirety except with written authorization from Western Electro-Acoustic Laboratory

WESTERN ELECTRO-ACOUSTIC LABORATORY

Report No. TL13-405

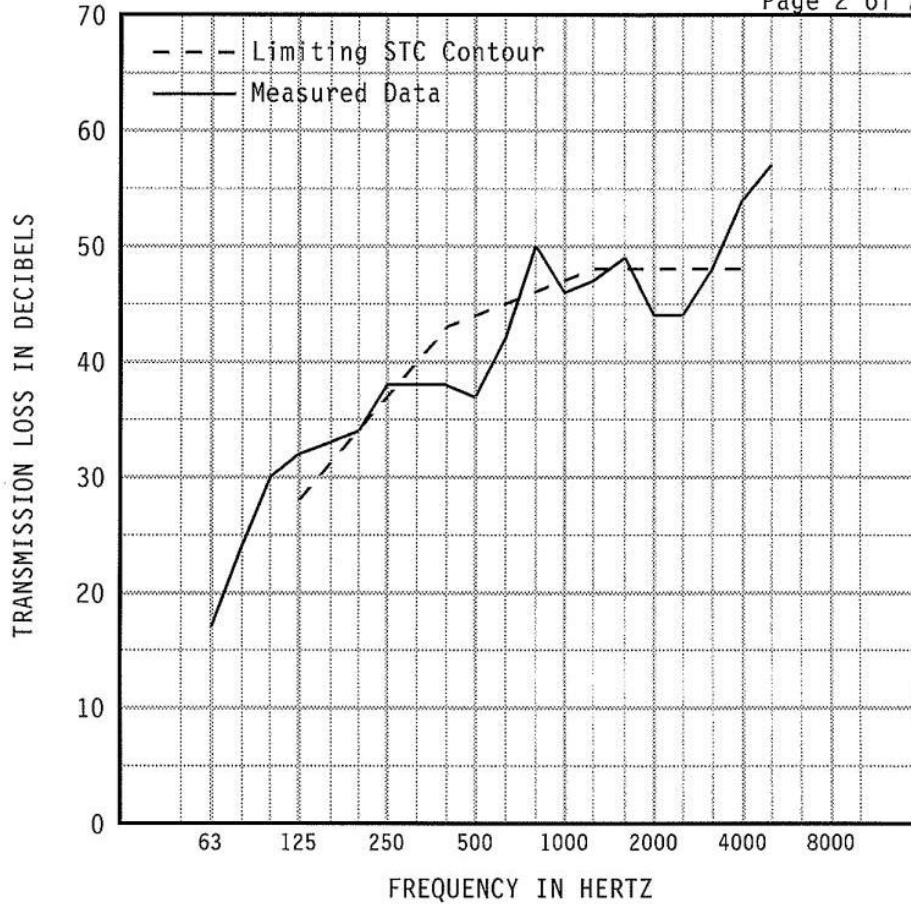

1/3 OCT BND CNTR FREQ	63	80	100	125	160	200	250	315	400	500
TL in dB	*17	*24	*30	*32	*33	34	38	38	38	37
95% Confidence in dB deficiencies	1.42	1.92	2.07	1.47	0.89	0.76 (0)	0.80	0.52 (2)	0.36 (5)	0.38 (7)
1/3 OCT BND CNTR FREQ	630	800	1000	1250	1600	2000	2500	3150	4000	5000
TL in dB	42	50	46	47	49	44	44	48	54	57
95% Confidence in dB deficiencies	0.29 (3)	0.44	0.38 (1)	0.39 (1)	0.36	0.56 (4)	0.55 (4)	0.31 (0)	0.32	0.50

EWR	OITC	* Minimum estimate of transmission loss. Measurement limited by filler wall. Actual TL will be equal to or greater than value reported.	Specimen Area: 3.02 sq.ft. Temperature: 77 deg. F Relative Humidity: 32 % Test Date: 20 July 2013	STC
45	38			44 (27)

Report must be distributed in its entirety except with written authorization from Western Electro-Acoustic Laboratory

WESTERN ELECTRO-ACOUSTIC LABORATORY

Report No. TL13-406

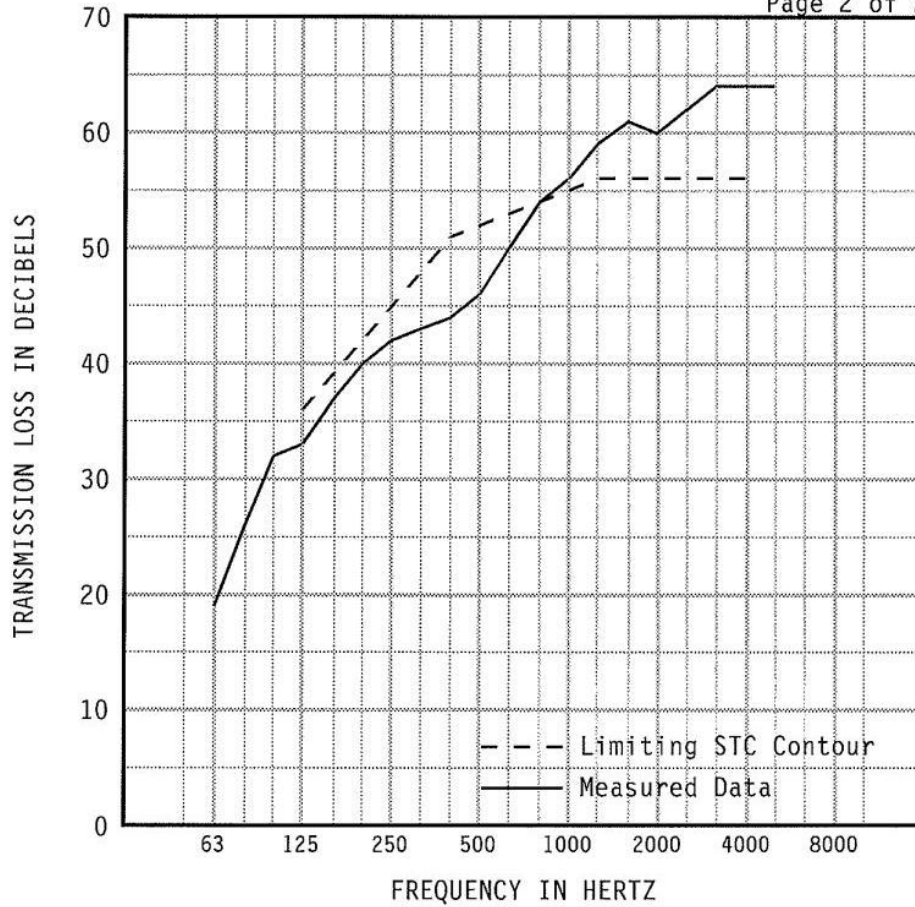

1/3 OCT BND CNTR FREQ	63	80	100	125	160	200	250	315	400	500
TL in dB	*19	*26	*32	*33	*37	*40	*42	*43	*44	46
95% Confidence in dB deficiencies	1.42	1.92	2.07	1.47 (3)	0.89 (2)	0.76 (2)	0.80 (3)	0.52 (5)	0.36 (7)	0.38 (6)
1/3 OCT BND CNTR FREQ	630	800	1000	1250	1600	2000	2500	3150	4000	5000
TL in dB	*50	*54	*56	*59	*61	*60	*62	*64	*64	*64
95% Confidence in dB deficiencies	0.29 (3)	0.44 (0)	0.38	0.39	0.36	0.56	0.55	0.31	0.32	0.50

EWR	OITC
51	41

* Minimum estimate of transmission loss. Measurement limited by filler wall. Actual TL will be equal to or greater than value reported.

Specimen Area: 3.13 sq.ft.
 Temperature: 77.5 deg. F
 Relative Humidity: 32 %
 Test Date: 20 July 2013

STC
52
(31)

Report must be distributed in its entirety except with written authorization from Western Electro-Acoustic Laboratory

WESTERN ELECTRO-ACOUSTIC LABORATORY

Report No. TL13-407

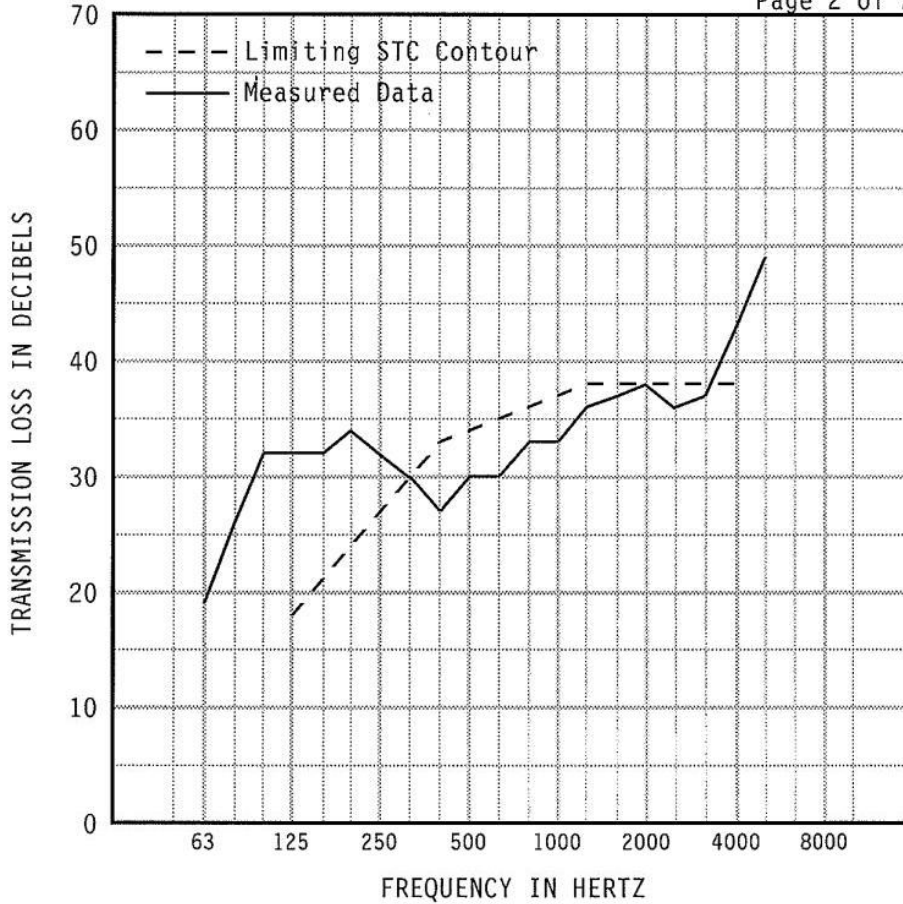

1/3 OCT BND CNTR FREQ	63	80	100	125	160	200	250	315	400	500
TL in dB	*19	*26	*32	*32	32	34	32	30	27	30
95% Confidence in dB deficiencies	1.42	1.92	2.07	1.47	0.89	0.76	0.80	0.52 (0)	0.36 (6)	0.38 (4)
1/3 OCT BND CNTR FREQ	630	800	1000	1250	1600	2000	2500	3150	4000	5000
TL in dB	30	33	33	36	37	38	36	37	43	49
95% Confidence in dB deficiencies	0.29 (5)	0.44 (3)	0.38 (4)	0.39 (2)	0.36 (1)	0.56 (0)	0.55 (2)	0.31 (1)	0.32	0.50

EWR	OITC
36	32

* Minimum estimate of transmission loss. Measurement limited by filler wall. Actual TL will be equal to or greater than value reported.

Specimen Area: 3.13 sq.ft.
 Temperature: 73.6 deg. F
 Relative Humidity: 40 %
 Test Date: 20 July 2013

STC
34
(28)

Report must be distributed in its entirety except with written authorization from Western Electro-Acoustic Laboratory

WESTERN ELECTRO-ACOUSTIC LABORATORY

Report No. TL13-408

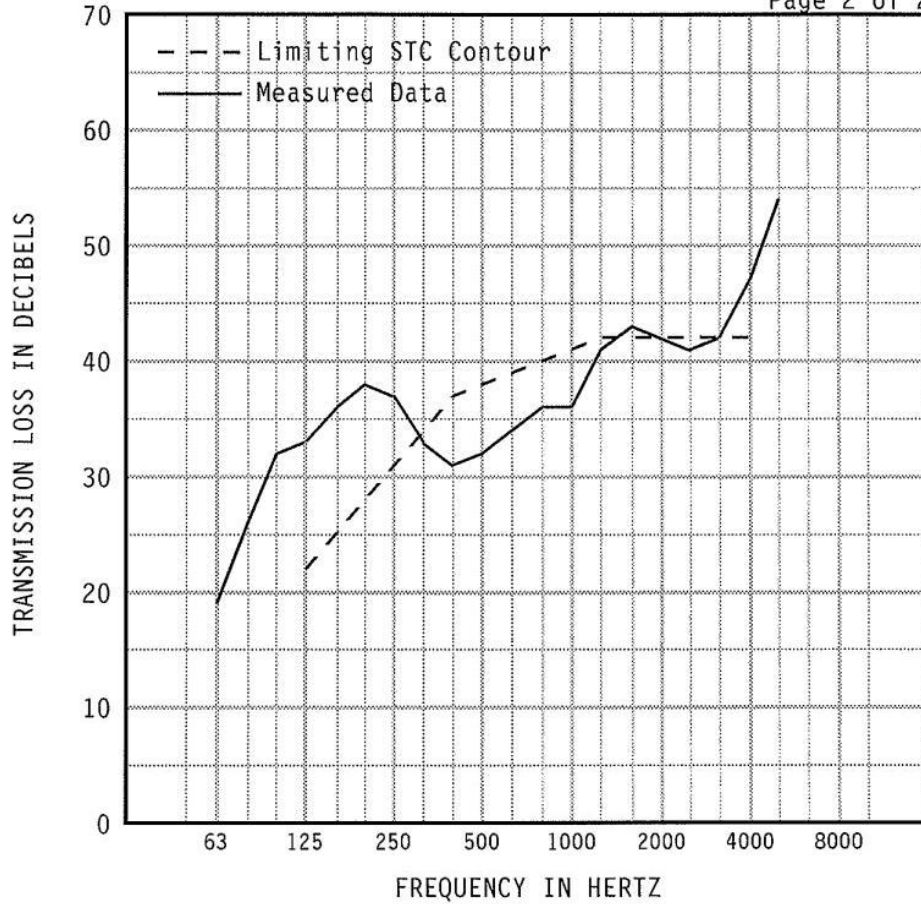

1/3 OCT BND CNTR	FREQ	63	80	100	125	160	200	250	315	400	500
TL in dB		*19	*26	*32	*33	*36	*38	37	33	31	32
95% Confidence in dB		1.42	1.92	2.07	1.47	0.89	0.76	0.80	0.52	0.36	0.38
	deficiencies								(1)	(6)	(6)
1/3 OCT BND CNTR	FREQ	630	800	1000	1250	1600	2000	2500	3150	4000	5000
TL in dB		34	36	36	41	43	42	41	42	47	54
95% Confidence in dB		0.29	0.44	0.38	0.39	0.36	0.56	0.55	0.31	0.32	0.50
	deficiencies	(5)	(4)	(5)	(1)		(0)	(1)	(0)		

EWR	OITC	* Minimum estimate of transmission loss. Measurement limited by filler wall. Actual TL will be equal to or greater than value reported.	Specimen Area: 3.13 sq.ft. Temperature: 76.5 deg. F Relative Humidity: 40 % Test Date: 20 July 2013	STC
40	35			38 (29)

Report must be distributed in its entirety except with written authorization from Western Electro-Acoustic Laboratory

WESTERN ELECTRO-ACOUSTIC LABORATORY

Report No. TL13-411

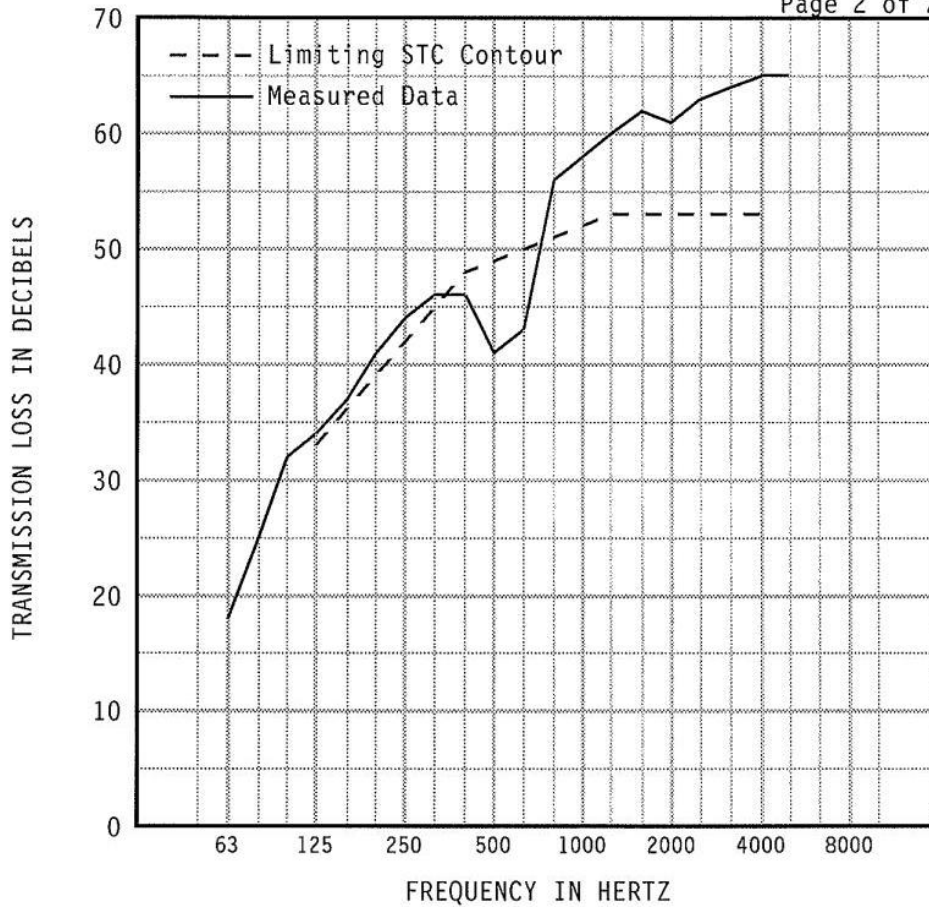

1/3 OCT BND CNTR	FREQ	63	80	100	125	160	200	250	315	400	500
TL in dB		*18	*25	*32	*34	*37	*41	*44	*46	*46	41
95% Confidence in dB	deficiencies	1.42	1.92	2.07	1.47	0.89	0.76	0.80	0.52	0.36	0.38
										(2)	(8)
1/3 OCT BND CNTR	FREQ	630	800	1000	1250	1600	2000	2500	3150	4000	5000
TL in dB		43	*56	*58	*60	*62	*61	*63	*64	*65	*65
95% Confidence in dB	deficiencies	0.29	0.44	0.38	0.39	0.36	0.56	0.55	0.31	0.32	0.50
			(7)								

EWR	OITC	* Minimum estimate of transmission loss. Measurement limited by filler wall. Actual TL will be equal to or greater than value reported. Specimen Area: 3.13 sq.ft. Temperature: 77.7 deg. F Relative Humidity: 43 % Test Date: 20 July 2013	STC
50	41		49 (17)

Report must be distributed in its entirety except with written authorization from Western Electro-Acoustic Laboratory

WESTERN ELECTRO-ACOUSTIC LABORATORY

Report No. TL13-412

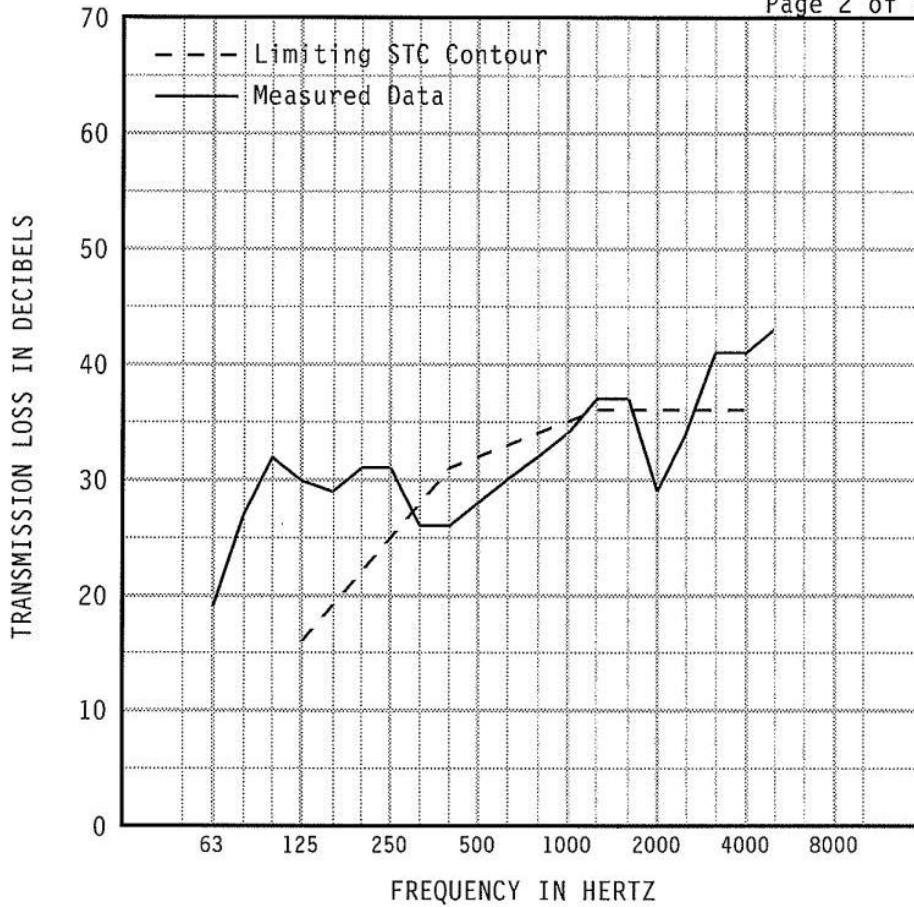

1/3 OCT BND CNTR FREQ	63	80	100	125	160	200	250	315	400	500
TL in dB	*19	*27	*32	*30	29	31	31	26	26	28
95% Confidence in dB deficiencies	1.42	1.92	2.07	1.47	0.89	0.76	0.80	0.52 (2)	0.36 (5)	0.38 (4)
1/3 OCT BND CNTR FREQ	630	800	1000	1250	1600	2000	2500	3150	4000	5000
TL in dB	30	32	34	37	37	29	34	41	41	43
95% Confidence in dB deficiencies	0.29 (3)	0.44 (2)	0.38 (1)	0.39	0.36	0.56 (7)	0.55 (2)	0.31	0.32	0.50

EWR	OITC
34	30

* Minimum estimate of transmission loss. Measurement limited by filler wall. Actual TL will be equal to or greater than value reported.

Specimen Area: 3.75 sq.ft.
 Temperature: 74.5 deg. F
 Relative Humidity: 44 %
 Test Date: 20 July 2013

STC
32 (26)

Report must be distributed in its entirety except with written authorization from Western Electro-Acoustic Laboratory

WESTERN ELECTRO-ACOUSTIC LABORATORY

Report No. TL13-413

Page 2 of 2

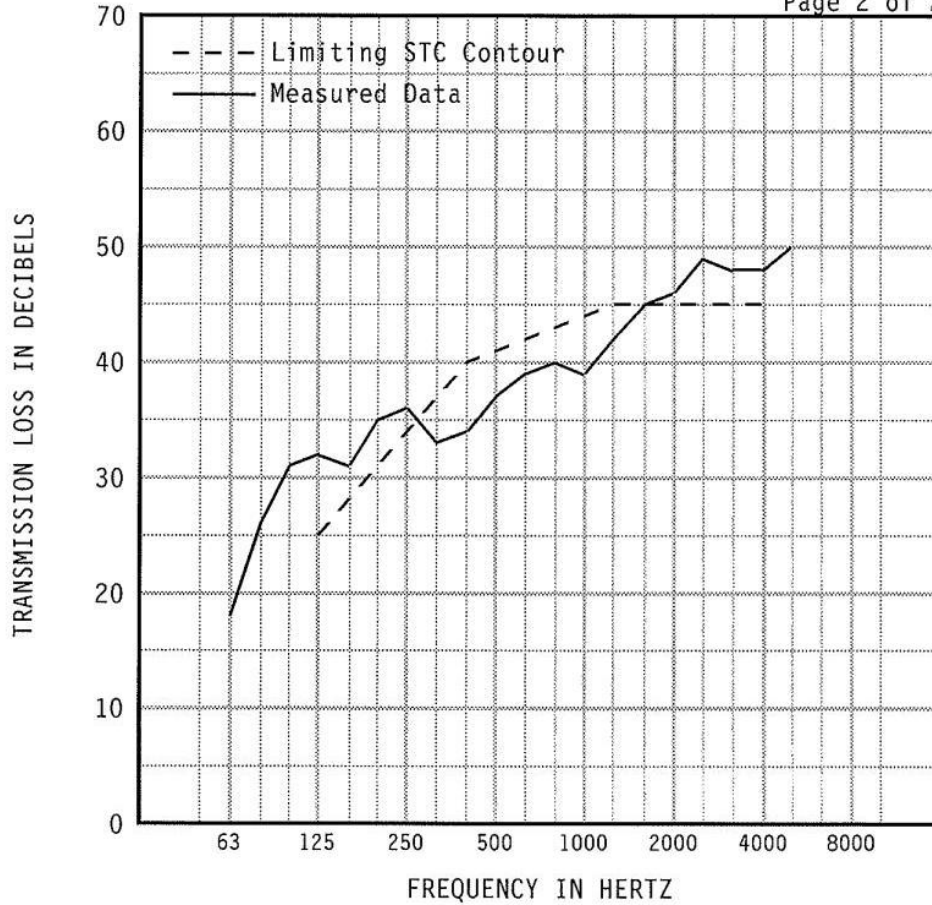

1/3 OCT BND CNTR	FREQ	63	80	100	125	160	200	250	315	400	500
TL in dB		*18	*26	*31	*32	31	35	36	33	34	37
95% Confidence in dB deficiencies		1.42	1.92	2.07	1.47	0.89	0.76	0.80	0.52 (4)	0.36 (6)	0.38 (4)
1/3 OCT BND CNTR	FREQ	630	800	1000	1250	1600	2000	2500	3150	4000	5000
TL in dB		39	40	39	42	45	46	49	48	48	50
95% Confidence in dB deficiencies		0.29 (3)	0.44 (3)	0.38 (5)	0.39 (3)	0.36 (0)	0.56	0.55	0.31	0.32	0.50

EWR	OITC	* Minimum estimate of transmission loss. Measurement limited by filler wall. Actual TL will be equal to or greater than value reported.	Specimen Area: 2.81 sq.ft. Temperature: 77.5 deg. F Relative Humidity: 46 % Test Date: 20 July 2013	STC
42	37			41 (28)

Report must be distributed in its entirety except with written authorization from Western Electro-Acoustic Laboratory

WESTERN ELECTRO-ACOUSTIC LABORATORY

Report No. TL13-414

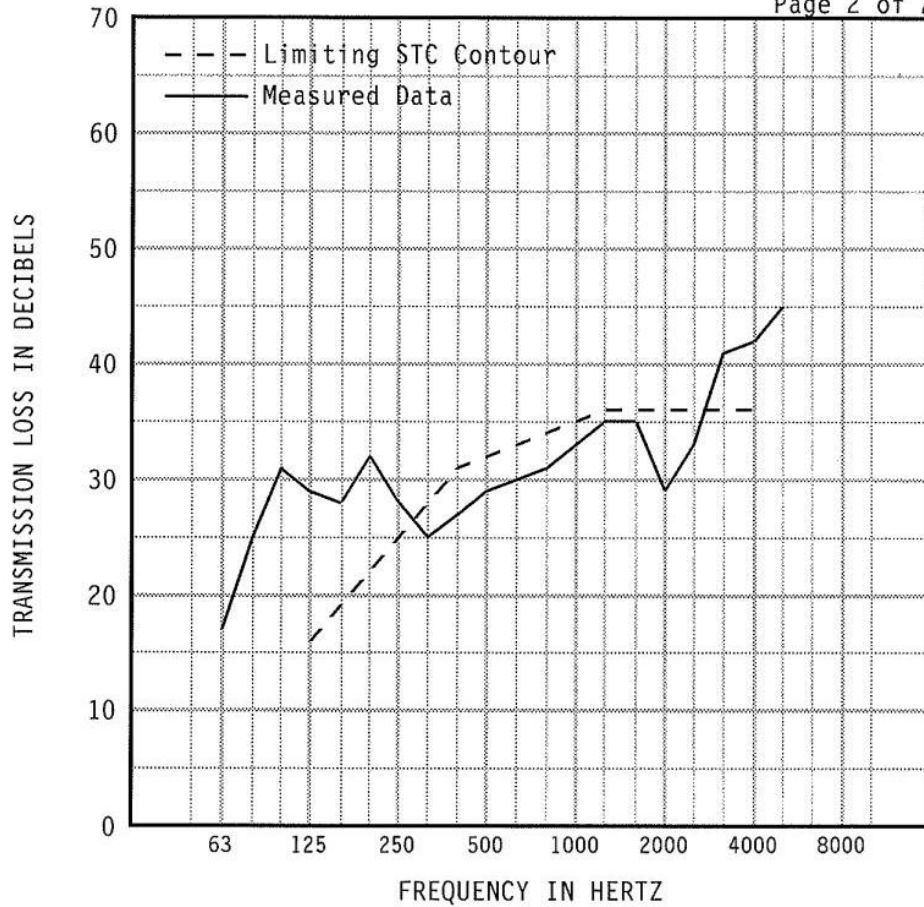

1/3 OCT BND CNTR	FREQ	63	80	100	125	160	200	250	315	400	500
TL in dB		*17	*25	*31	*29	28	32	28	25	27	29
95% Confidence in dB deficiencies		1.42	1.92	2.07	1.47	0.89	0.76	0.80	0.52 (3)	0.36 (4)	0.38 (3)
1/3 OCT BND CNTR	FREQ	630	800	1000	1250	1600	2000	2500	3150	4000	5000
TL in dB		30	31	33	35	35	29	33	41	42	45
95% Confidence in dB deficiencies		0.29 (3)	0.44 (3)	0.38 (2)	0.39 (1)	0.36 (1)	0.56 (7)	0.55 (3)	0.31	0.32	0.50

EWR	OITC	* Minimum estimate of transmission loss. Measurement limited by filler wall. Actual TL will be equal to or greater than value reported.	Specimen Area: 2.81 sq. ft. Temperature: 77.5 deg. F Relative Humidity: 46 % Test Date: 20 July 2013	STC
34	30			32 (30)

Report must be distributed in its entirety except with written authorization from Western Electro-Acoustic Laboratory

WESTERN ELECTRO-ACOUSTIC LABORATORY

Report No. TL13-415

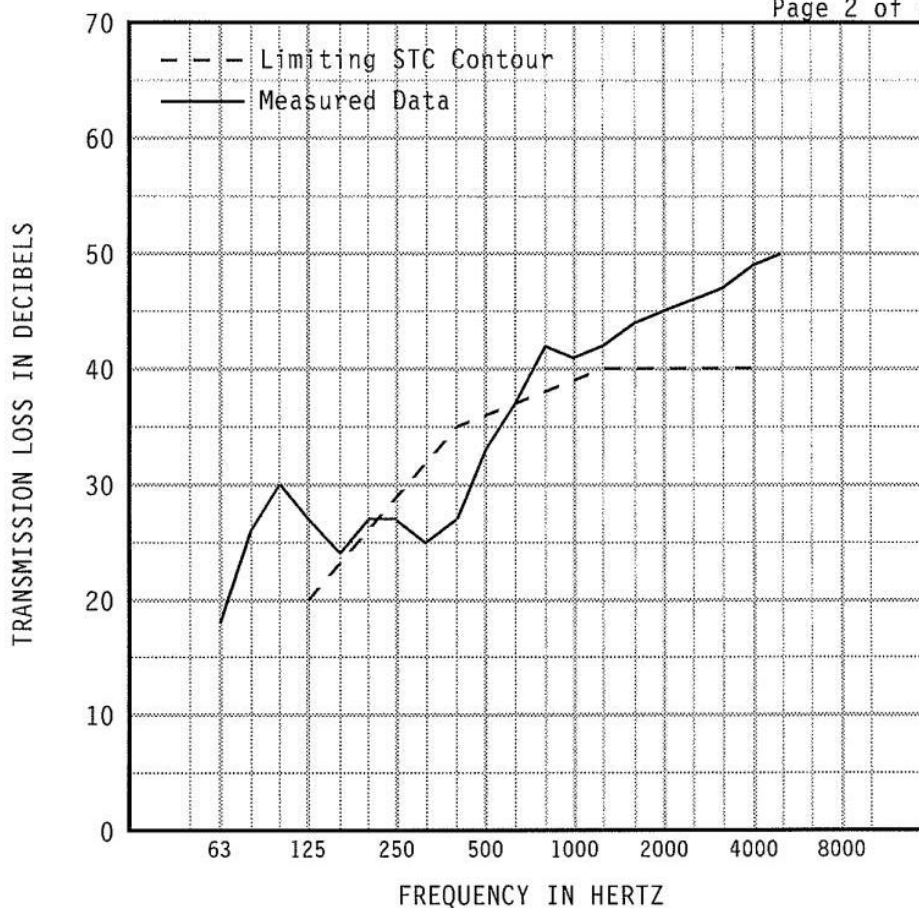

1/3 OCT BND CNTR	FREQ	63	80	100	125	160	200	250	315	400	500
TL in dB		*18	*26	*30	27	24	27	27	25	27	33
95% Confidence in dB deficiencies		1.42	1.92	2.07	1.47	0.89	0.76	0.80 (2)	0.52 (7)	0.36 (8)	0.38 (3)
1/3 OCT BND CNTR	FREQ	630	800	1000	1250	1600	2000	2500	3150	4000	5000
TL in dB		37	42	41	42	44	45	46	47	49	50
95% Confidence in dB deficiencies		0.29 (0)	0.44	0.38	0.39	0.36	0.56	0.55	0.31	0.32	0.50

EWR	OITC	* Minimum estimate of transmission loss. Measurement limited by filler wall. Actual TL will be equal to or greater than value reported. Specimen Area: 2.81 sq.ft. Temperature: 78.6 deg. F Relative Humidity: 50 % Test Date: 20 July 2013	STC
37	31		36 (20)

Report must be distributed in its entirety except with written authorization from Western Electro-Acoustic Laboratory

WESTERN ELECTRO-ACOUSTIC LABORATORY

Report No. TL13-416

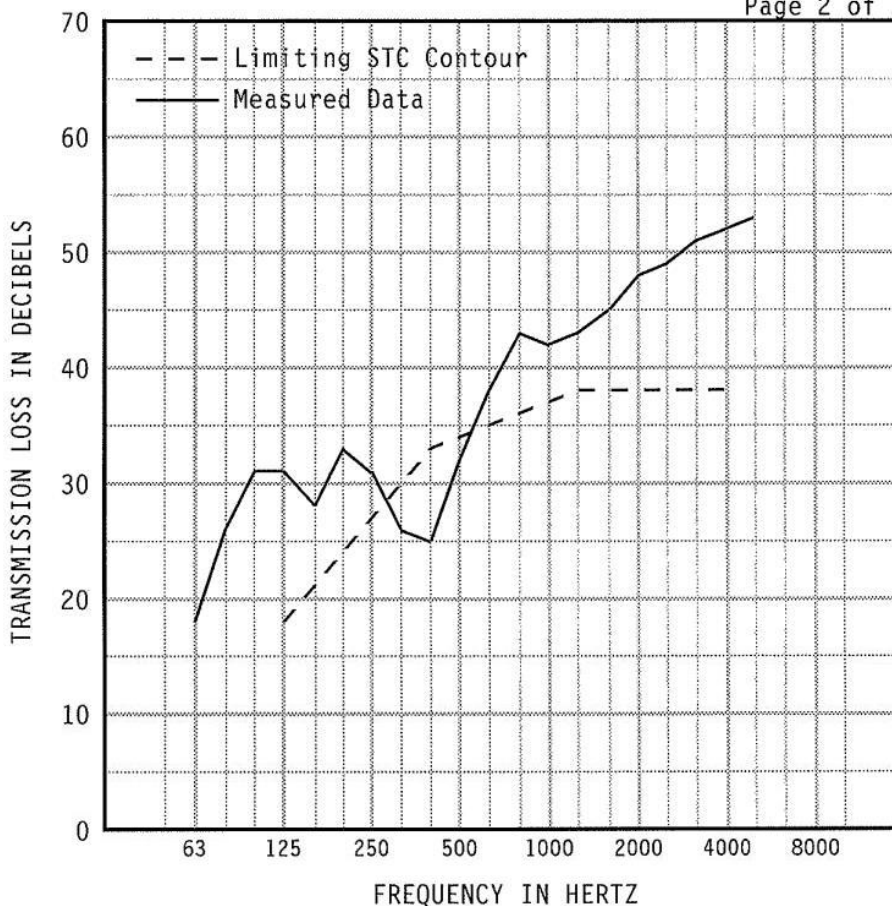

1/3 OCT BND CNTR FREQ	63	80	100	125	160	200	250	315	400	500
TL in dB	*18	*26	*31	*31	28	33	31	26	25	32
95% Confidence in dB deficiencies	1.42	1.92	2.07	1.47	0.89	0.76	0.80	0.52 (4)	0.36 (8)	0.38 (2)
1/3 OCT BND CNTR FREQ	630	800	1000	1250	1600	2000	2500	3150	4000	5000
TL in dB	38	43	42	43	45	48	49	51	52	53
95% Confidence in dB deficiencies	0.29	0.44	0.38	0.39	0.36	0.56	0.55	0.31	0.32	0.50
EWR 39	OITC 32	* Minimum estimate of transmission loss. Measurement limited by filler wall. Actual TL will be equal to or greater than value reported.								STC 34 (14)
Specimen Area: 2.81 sq.ft. Temperature: 78.6 deg. F Relative Humidity: 51 % Test Date: 20 July 2013										

Report must be distributed in its entirety except with written authorization from Western Electro-Acoustic Laboratory

WESTERN ELECTRO-ACOUSTIC LABORATORY

Report No. TL13-417

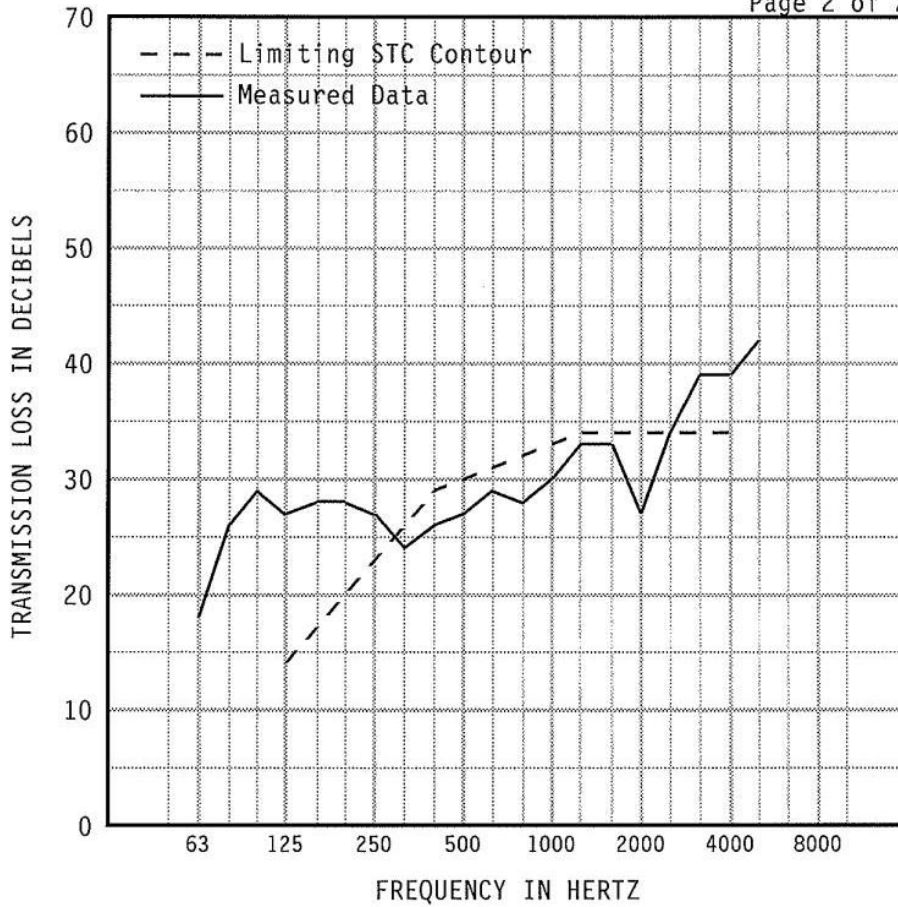

1/3 OCT BND CNTR FREQ	63	80	100	125	160	200	250	315	400	500
TL in dB	*18	*26	*29	27	28	28	27	24	26	27
95% Confidence in dB deficiencies	1.42	1.92	2.07	1.47	0.89	0.76	0.80	0.52 (2)	0.36 (3)	0.38 (3)
1/3 OCT BND CNTR FREQ	630	800	1000	1250	1600	2000	2500	3150	4000	5000
TL in dB	29	28	30	33	33	27	34	39	39	42
95% Confidence in dB deficiencies	0.29 (2)	0.44 (4)	0.38 (3)	0.39 (1)	0.36 (1)	0.56 (7)	0.55 (0)	0.31	0.32	0.50

EWR	OITC	* Minimum estimate of transmission loss. Measurement limited by filler wall. Actual TL will be equal to or greater than value reported.	Specimen Area: 2.81 sq.ft. Temperature: 78.8 deg. F Relative Humidity: 50 % Test Date: 20 July 2013	STC
32	28			30 (26)

Report must be distributed in its entirety except with written authorization from Western Electro-Acoustic Laboratory

WESTERN ELECTRO-ACOUSTIC LABORATORY

Report No. TL13-418

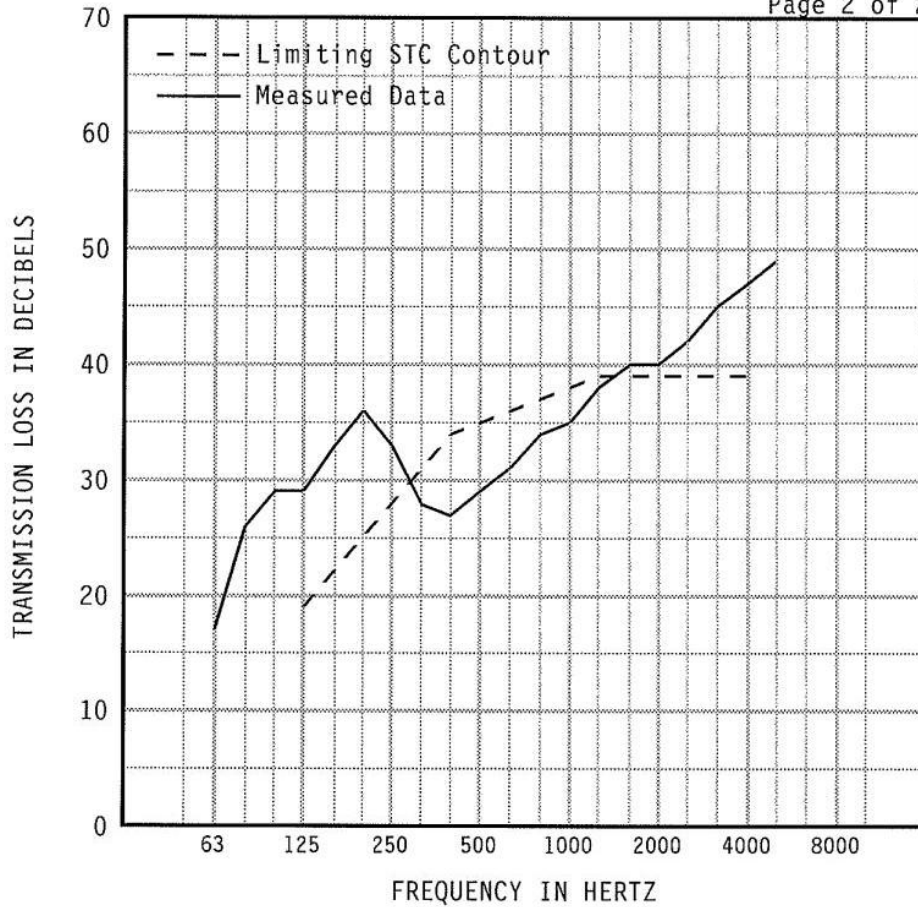

1/3 OCT BND CNTR FREQ	63	80	100	125	160	200	250	315	400	500
TL in dB	*17	*26	*29	*29	*33	36	33	28	27	29
95% Confidence in dB deficiencies	1.42	1.92	2.07	1.47	0.89	0.76	0.80	0.52 (3)	0.36 (7)	0.38 (6)
1/3 OCT BND CNTR FREQ	630	800	1000	1250	1600	2000	2500	3150	4000	5000
TL in dB	31	34	35	38	40	40	42	45	47	49
95% Confidence in dB deficiencies	0.29 (5)	0.44 (3)	0.38 (3)	0.39 (1)	0.36	0.56	0.55	0.31	0.32	0.50

EWR	OITC	* Minimum estimate of transmission loss. Measurement limited by filler wall. Actual TL will be equal to or greater than value reported.	Specimen Area: 2.81 sq.ft. Temperature: 78.8 deg. F Relative Humidity: 48 % Test Date: 20 July 2013	STC
37	32			35 (28)

Report must be distributed in its entirety except with written authorization from Western Electro-Acoustic Laboratory

WESTERN ELECTRO-ACOUSTIC LABORATORY

Report No. TL13-419

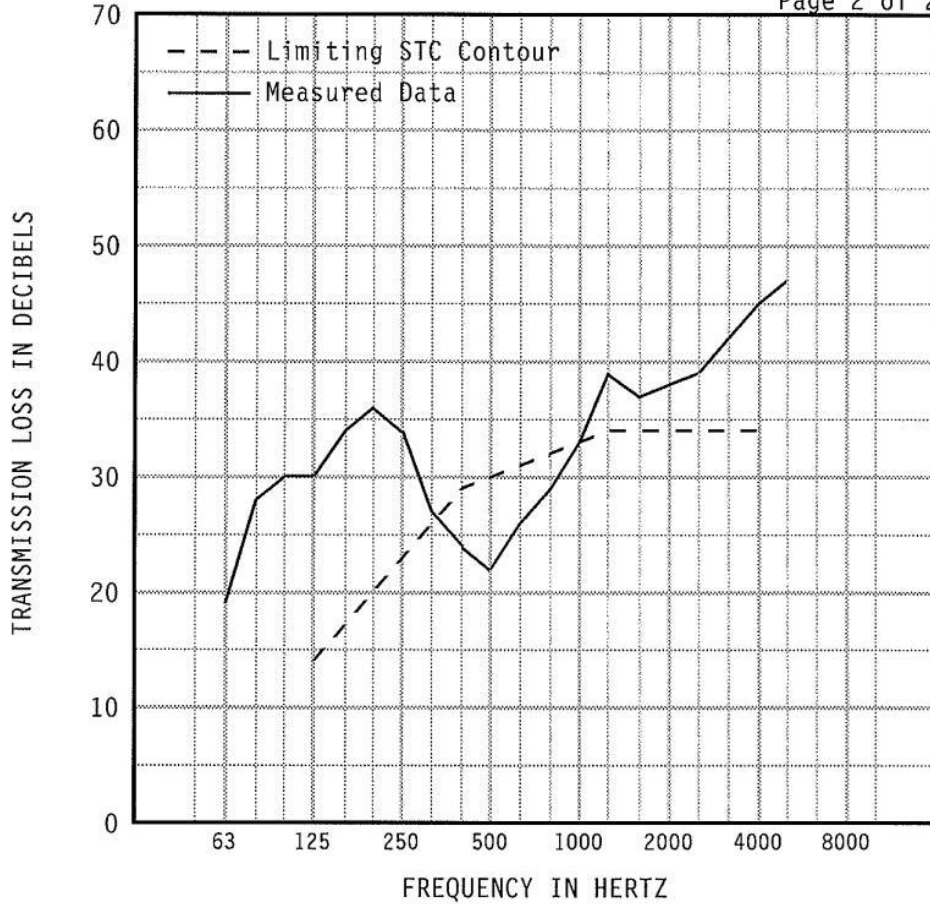

1/3 OCT BND CNTR	FREQ	63	80	100	125	160	200	250	315	400	500
TL in dB		*19	*28	*30	*30	*34	36	34	27	24	22
95% Confidence in dB	deficiencies	1.42	1.92	2.07	1.47	0.89	0.76	0.80	0.52	0.36	0.38
										(5)	(8)
1/3 OCT BND CNTR	FREQ	630	800	1000	1250	1600	2000	2500	3150	4000	5000
TL in dB		26	29	33	39	37	38	39	42	45	47
95% Confidence in dB	deficiencies	0.29	0.44	0.38	0.39	0.36	0.56	0.55	0.31	0.32	0.50
			(5)	(3)	(0)						

EWR	OITC	* Minimum estimate of transmission loss. Measurement limited by filler wall. Actual TL will be equal to or greater than value reported.	Specimen Area: 3.75 sq.ft. Temperature: 78.8 deg. F Relative Humidity: 47 % Test Date: 20 July 2013	STC
33	28			30 (21)

Report must be distributed in its entirety except with written authorization from Western Electro-Acoustic Laboratory

2 SILICONE
2 metal
Bare mullion

WESTERN ELECTRO-ACOUSTIC LABORATORY

Report No. TL13-420

1000 419

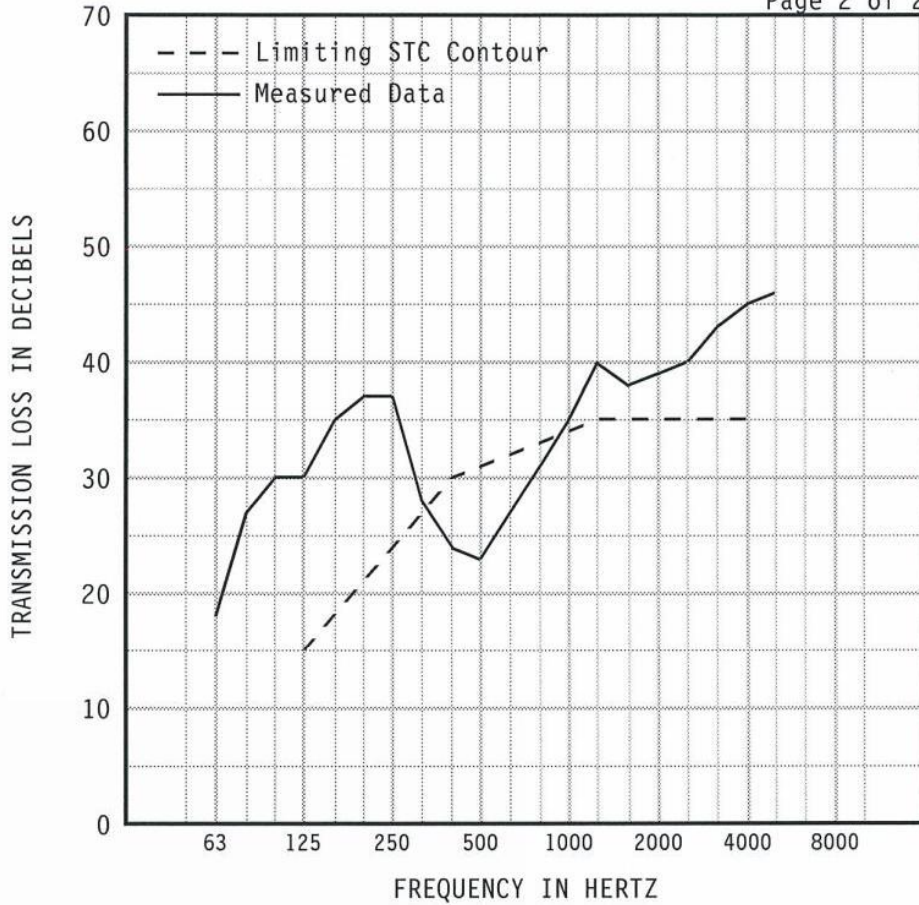

1/3 OCT BND CNTR	FREQ	63	80	100	125	160	200	250	315	400	500
TL in dB		*18	*27	*30	*30	*35	37	37	28	24	23
95% Confidence in dB deficiencies		1.42	1.92	2.07	1.47	0.89	0.76	0.80	0.52	0.36 (6)	0.38 (8)
1/3 OCT BND CNTR	FREQ	630	800	1000	1250	1600	2000	2500	3150	4000	5000
TL in dB		27	31	35	40	38	39	40	43	45	46
95% Confidence in dB deficiencies		0.29 (5)	0.44 (2)	0.38	0.39	0.36	0.56	0.55	0.31	0.32	0.50

EWR	OITC	* Minimum estimate of transmission loss. Measurement limited by filler wall. Actual TL will be equal to or greater than value reported.	Specimen Area: 3.75 sq.ft.	STC
34	29		Temperature: 76.1 deg. F	31
			Relative Humidity: 42 %	(21)
			Test Date: 20 July 2013	

Report must be distributed in its entirety except with written authorization from Western Electro-Acoustic Laboratory

1 silicone
2 metal
Bare mullion

WESTERN ELECTRO-ACOUSTIC LABORATORY

Report No. TL13-421

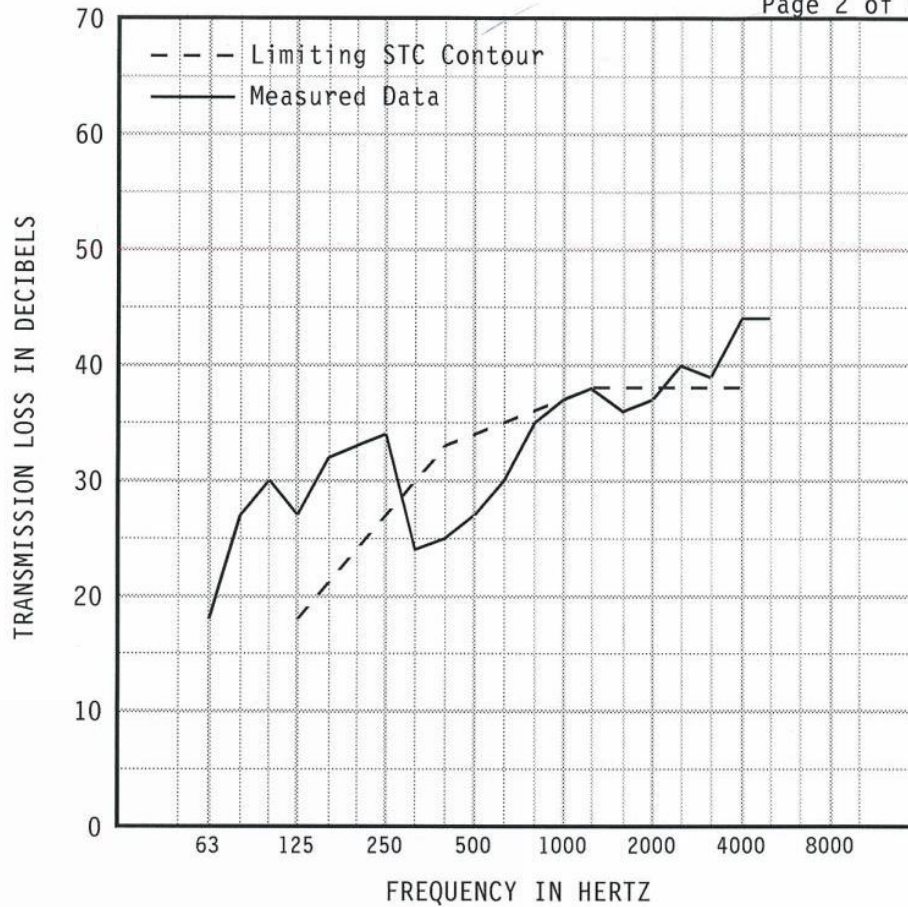

1/3 OCT BND CNTR	FREQ	63	80	100	125	160	200	250	315	400	500
TL in dB		*18	*27	*30	27	32	33	34	24	25	27
95% Confidence in dB deficiencies		1.42	1.92	2.07	1.47	0.89	0.76	0.80	0.52 (6)	0.36 (8)	0.38 (7)
1/3 OCT BND CNTR	FREQ	630	800	1000	1250	1600	2000	2500	3150	4000	5000
TL in dB		30	35	37	38	36	37	40	39	44	44
95% Confidence in dB deficiencies		0.29 (5)	0.44 (1)	0.38 (0)	0.39 (0)	0.36 (2)	0.56 (1)	0.55	0.31	0.32	0.50

EWR	OITC
35	30

* Minimum estimate of transmission loss. Measurement limited by filler wall. Actual TL will be equal to or greater than value reported.

Specimen Area: 3.75 sq.ft.
Temperature: 77.7 deg. F
Relative Humidity: 40 %
Test Date: 20 July 2013

STC
34 (30)

Report must be distributed in its entirety except with written authorization from Western Electro-Acoustic Laboratory

Bare mullion
w/ 2 metal
sheets only

7/20/2013

WESTERN ELECTRO-ACOUSTIC LABORATORY

Report No. TL13-422

Page 2 of 2

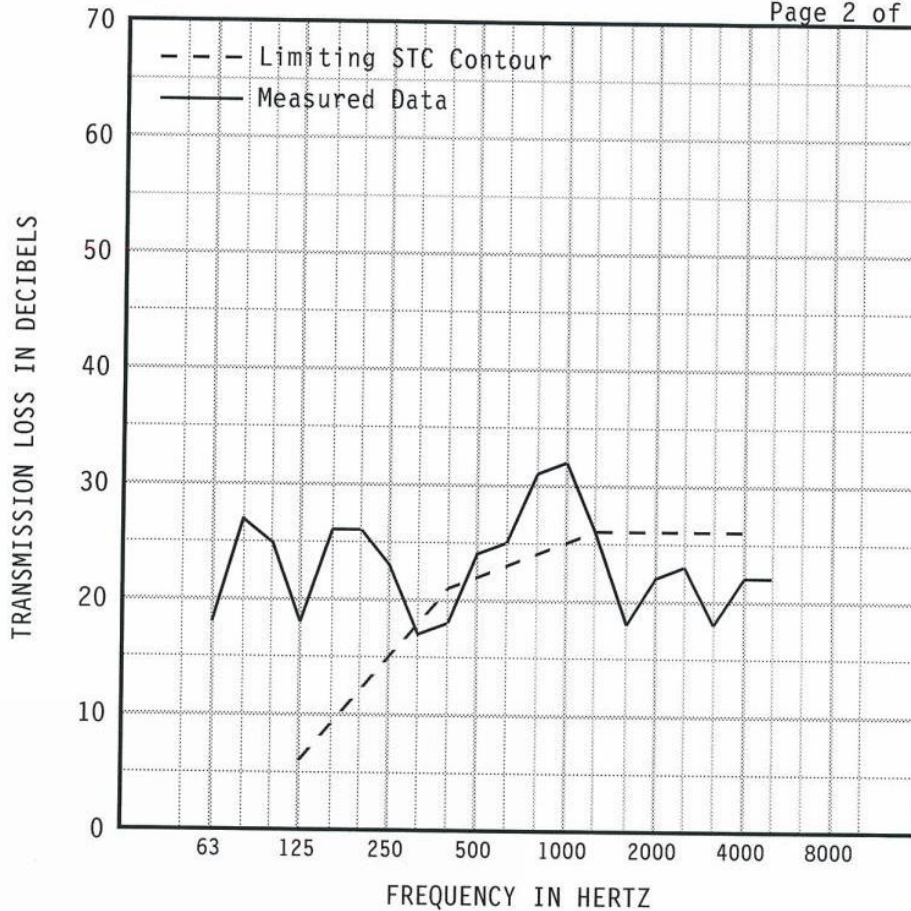

1/3 OCT BND CNTR FREQ	63	80	100	125	160	200	250	315	400	500
TL in dB	*18	*27	25	18	26	26	23	17	18	24
95% Confidence in dB deficiencies	1.42	1.92	2.07	1.47	0.89	0.76	0.80	0.52 (1)	0.36 (3)	0.38
1/3 OCT BND CNTR FREQ	630	800	1000	1250	1600	2000	2500	3150	4000	5000
TL in dB	25	31	32	26	18	22	23	18	22	22
95% Confidence in dB deficiencies	0.29	0.44	0.38	0.39 (0)	0.36 (8)	0.56 (4)	0.55 (3)	0.31 (8)	0.32 (4)	0.50

EWR	OITC	* Minimum estimate of transmission loss. Measurement limited by filler wall. Actual TL will be equal to or greater than value reported.	Specimen Area: 3.75 sq.ft. Temperature: 75.2 deg. F Relative Humidity: 42 % Test Date: 20 July 2013	STC
26	22			22 (31)

Report must be distributed in its entirety except with written authorization from Western Electro-Acoustic Laboratory

B.4 PHASE 2B WEAL TEST RESULTS

WEAL TL	STC	Area (SF) print out	Specimen (Connection)	Silicone Bulb Seal	Edge Seal
Plate/Airspace Series					
TL13-605	51	2.73	1/8" Alum. Plate 6" Cavity - NO Batt	Mullion edge	Bulb seal - mullion edge Putty - 3 sides
TL13-606	51	2.73	re-run		
TL13-607	51	2.73	re-run		
TL13-608	51	2.73	1/8" Alum. Plate 6" Cavity - FILLED batt insulation	Mullion edge	Bulb seal - mullion edge Putty - 3 sides
TL13-609	47	2.73	1/8" Alum. Plate 4" Cavity - NO Batt (LEAK)	Mullion edge	Bulb seal - mullion edge Putty - 3 sides
TL13-610	47		re-run		
TL13-611	49	2.73	1/8" Alum. Plate 4" Cavity - FILLED batt insulation	Mullion edge	Bulb seal - mullion edge Putty - 3 sides
TL13-612	44	2.73	1/8" Alum. Plate 3" Cavity - NO Batt	Mullion edge	Bulb seal - mullion edge Putty - 3 sides
TL13-613	47	2.73	1/8" Alum. Plate 3" Cavity - FILLED batt insulation	Mullion edge	Bulb seal - mullion edge Putty - 3 sides
TL13-614	46	2.73	1/8" Alum. Plate + MLV 3" Cavity - NO BATT	Mullion edge	Bulb seal - mullion edge Putty - 3 sides
TL13-615	48	2.73	1/8" Alum. Plate + MLV 3" Cavity - FILLED batt insulation	Mullion edge	Bulb seal - mullion edge Putty - 3 sides
TL13-616	45	2.73	5/8" gypsum board plates 3" Cavity - NO BATT	Mullion edge	Bulb seal - mullion edge Putty - 3 sides
TL13-617	48	2.73	5/8" gypsum board plates 3" Cavity - FILLED batt insulation	Mullion edge	Bulb seal - mullion edge Putty - 3 sides
TL13-618	50	2.73	5/8" gypsum board + MLV + Alum. Plate 3" Cavity - FILLED batt insulation	Mullion edge	Bulb seal - mullion edge Putty - 3 sides
TL13-619	47	2.73	5/8" gypsum board + MLV + Alum. Plate 3" cavity - NO Batt	Mullion edge	Bulb seal - mullion edge Putty - 3 sides
Staggered Series					
TL13-620	22	2.73	5/8" gypsum bd 2" overlap+ 1/4" air b/w plates NO Batt	none	
TL13-621	37	2.73	5/8" gypsum bd 2" overlap+ 1/4" air b/w plates Cavity - filled batt insulation	none	

WEAL TL	STC	Area (SF) print out	Specimen (Connection)	Silicone Bulb Seal	Edge Seal
TL13-622	51	2.73	5/8" gypsum bd 2" overlap+ 1/4" air b/w plates Cavity - filled batt insulation	1 - receiver side 1 - source side	
TL13-623	44	2.73	5/8" gypsum bd 2" overlap+ 1/4" air b/w plates NO Batt	1 - receiver side 1 - source side	
TL13-624	47	2.73	5/8" gypsum bd 2" overlap+ 1/4" air b/w plates NO Batt	2 - receiver side 1 - source side	
TL13-625	20	2.73	1/8" aluminum plates (4'x60") 2" overlap+ 1/4" air b/w plates NO Batt	none	Putty Edge
TL13-626	31	2.73	1/8" aluminum plates (4'x60") 2" overlap+ 1/4" air b/w plates Cavity - filled batt insulation	none	Putty Edge
TL13-627	49	2.73	1/8" aluminum plates (4'x60") 2" overlap+ 1/4" air b/w plates Cavity - filled batt insulation	1 - receiver side 1 - source side	Putty Edge
TL13-628	47	2.73	1/8" aluminum plates (4'x60") 2" overlap+ 1/4" air b/w plates NO Batt	1 - receiver side 1 - source side	Putty Edge
TL13-629	48	2.73	1/8" aluminum plates (4'x60") 2" overlap+ 1/4" air b/w plates NO Batt	2 - receiver side 1 - source side	Putty Edge
Products					
TL13-630	23	1.41	Mullion Mate ONLY		top/bottom - putty vert sides - wet seal 2x6 on either side
TL13-631	30	4.22	Mullion Mate BARE MULLION		Wet Seal
TL13-632	31	4.22	Mullion Mate BEST MULLION		Wet Seal
TL13-633	50	2.81	Mull-it-over isolated leaves NO MULLION		Wet Seal

TABLE B- 4: PHASE 2B, WEAL TEST NUMBERS, AREA AND DESCRIPTION

Note:

WEAL tests TL13-605 through TL13-629: The TL was reduced by 0.38 dB to adjust to the specimen area (6" x 60") from the opening area (6.5" x 60.5") which was used in the original TL calculations.

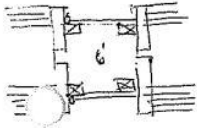

1" ALUM PLATES
6" AIR SPACE
BEAD SEAL ON ONE SIDE

WESTERN ELECTRO-ACOUSTIC LABORATORY
Report No. TL13-605

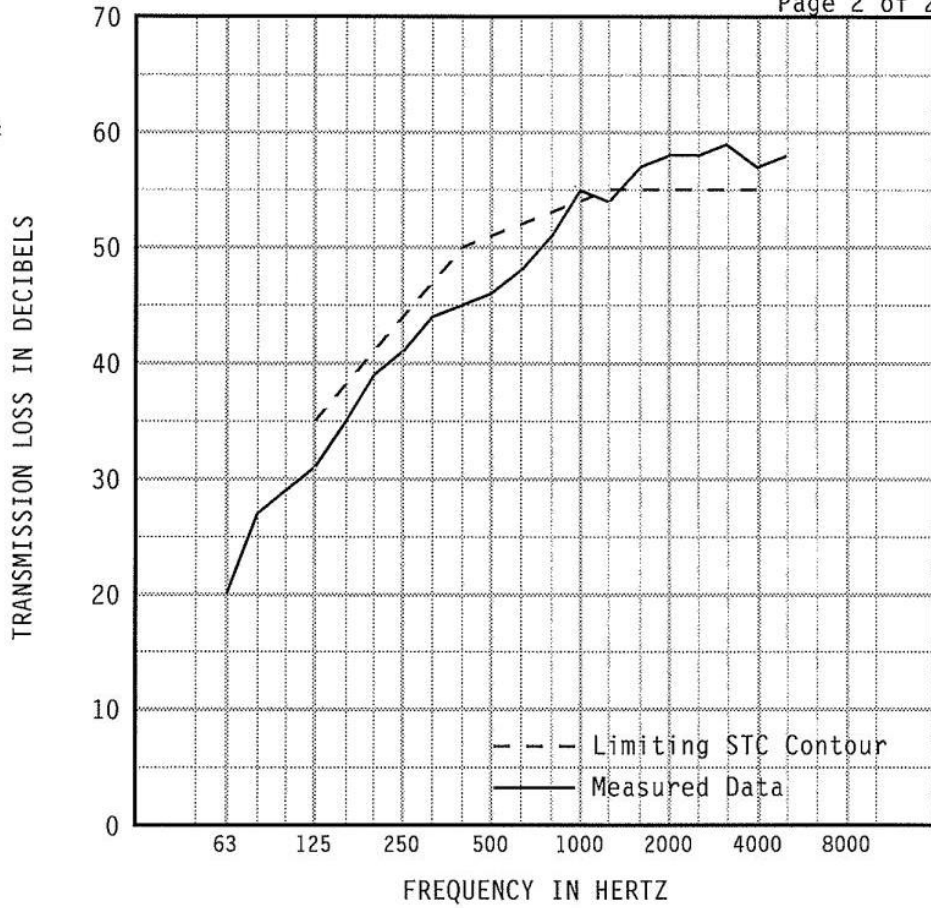

1/3 OCT BND CNTR FREQ	63	80	100	125	160	200	250	315	400	500
TL in dB	*20	*27	*29	*31	*35	*39	*41	*44	*45	*46
95% Confidence in dB deficiencies	1.42	1.92	2.07	1.47	0.89	0.76	0.80	0.52	0.36	0.38
				(4)	(3)	(2)	(3)	(3)	(5)	(5)
1/3 OCT BND CNTR FREQ	630	800	1000	1250	1600	2000	2500	3150	4000	5000
TL in dB	*48	51	*55	54	57	*58	*58	59	57	58
95% Confidence in dB deficiencies	0.29	0.44	0.38	0.39	0.36	0.56	0.55	0.31	0.32	0.50
				(1)						

EWR	OITC	* Minimum estimate of transmission loss. Measurement limited by filler wall. Actual TL will be equal to or greater than value reported.	Specimen Area: 2.73 sq.ft. Temperature: 76.8 deg. F Relative Humidity: 32 % Test Date: 08 October 2013	STC
50	40			51
				(32)

Report must be distributed in its entirety except with written authorization from Western Electro-Acoustic Laboratory

6" AIR
2 ALUM PLATES
RED D

WESTERN ELECTRO-ACOUSTIC LABORATORY

Report No. TL13-606

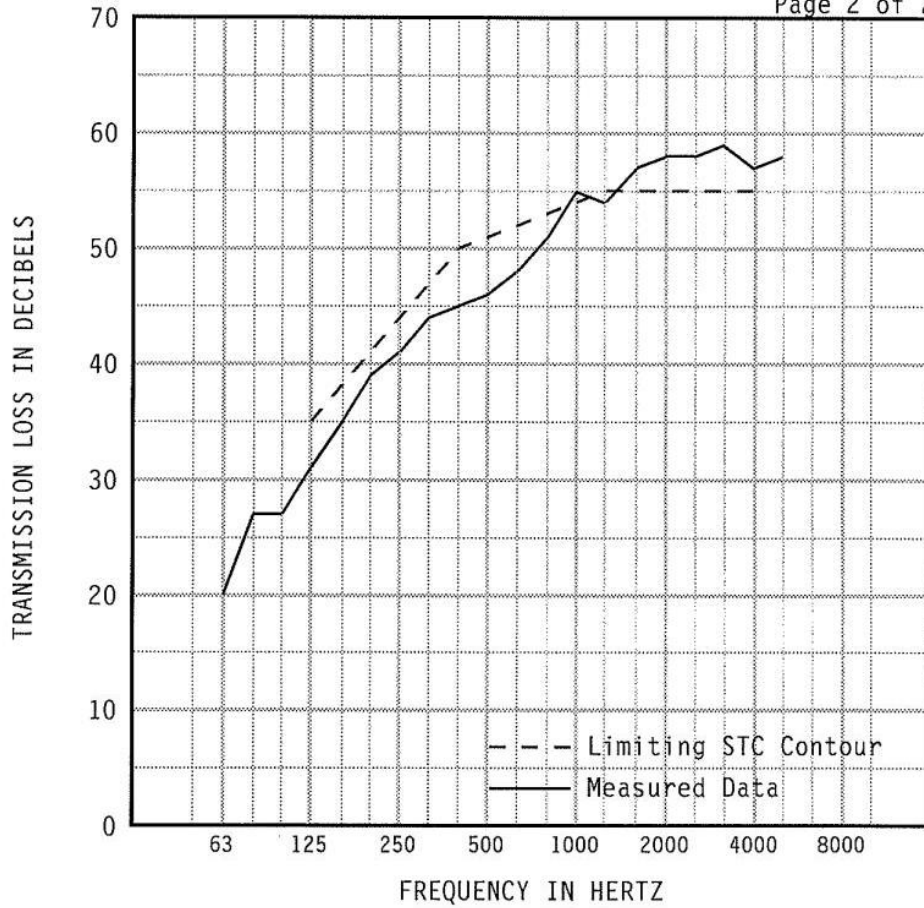

1/3 OCT BND CNTR FREQ	63	80	100	125	160	200	250	315	400	500
TL in dB	*20	*27	*27	*31	*35	*39	*41	*44	*45	*46
95% Confidence in dB deficiencies	1.42	1.92	2.07	1.47 (4)	0.89 (3)	0.76 (2)	0.80 (3)	0.52 (3)	0.36 (5)	0.38 (5)
1/3 OCT BND CNTR FREQ	630	800	1000	1250	1600	2000	2500	3150	4000	5000
TL in dB	*48	51	*55	54	57	*58	*58	59	57	58
95% Confidence in dB deficiencies	0.29 (4)	0.44 (2)	0.38	0.39 (1)	0.36	0.56	0.55	0.31	0.32	0.50

EWR	OITC	* Minimum estimate of transmission loss. Measurement limited by filler wall. Actual TL will be equal to or greater than value reported.	Specimen Area: 2.73 sq.ft. Temperature: 76.8 deg. F Relative Humidity: 32 % Test Date: 08 October 2013	STC
50	40			51 (32)

Report must be distributed in its entirety except with written authorization from Western Electro-Acoustic Laboratory

6" AIR
 (2) 1/2" ALUM PLATES

WESTERN ELECTRO-ACOUSTIC LABORATORY

Report No. TL13-607

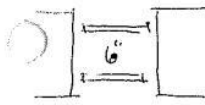

NO ERRORS

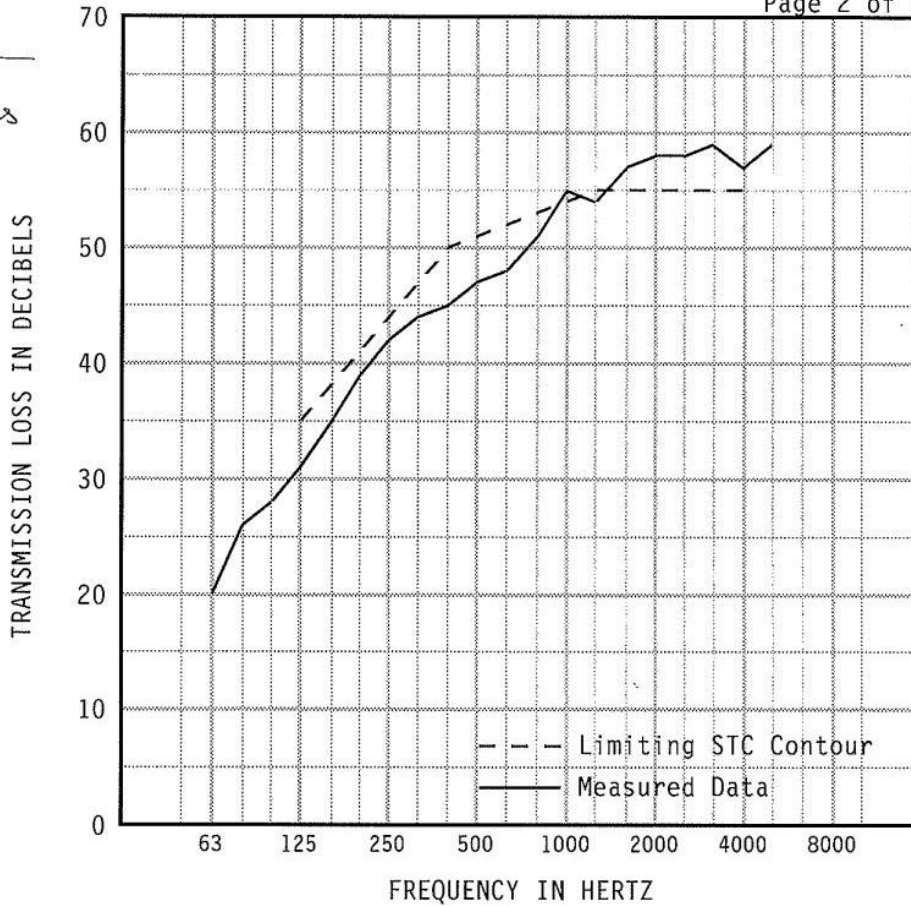

1/3 OCT BND CNTR FREQ	63	80	100	125	160	200	250	315	400	500
TL in dB	*20	*26	*28	*31	*35	*39	*42	*44	*45	*47
95% Confidence in dB deficiencies	1.42	1.92	2.07	1.47 (4)	0.89 (3)	0.76 (2)	0.80 (2)	0.52 (3)	0.36 (5)	0.38 (4)
1/3 OCT BND CNTR FREQ	630	800	1000	1250	1600	2000	2500	3150	4000	5000
TL in dB	*48	51	*55	54	57	*58	*58	59	57	59
95% Confidence in dB deficiencies	0.29 (4)	0.44 (2)	0.38	0.39 (1)	0.36	0.56	0.55	0.31	0.32	0.50

EWR	OITC	* Minimum estimate of transmission loss. Measurement limited by filler wall. Actual TL will be equal to or greater than value reported.	Specimen Area: 2.73 sq.ft. Temperature: 76.8 deg. F Relative Humidity: 32 % Test Date: 08 October 2013	STC
50	40			51 (30)

Report must be distributed in its entirety except with written authorization from Western Electro-Acoustic Laboratory

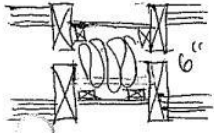

(2) 1/8" Alum
6" AIR SPACE
+ BATT INSUL
MIN WOOL

WESTERN ELECTRO-ACOUSTIC LABORATORY

Report No. TL13-608

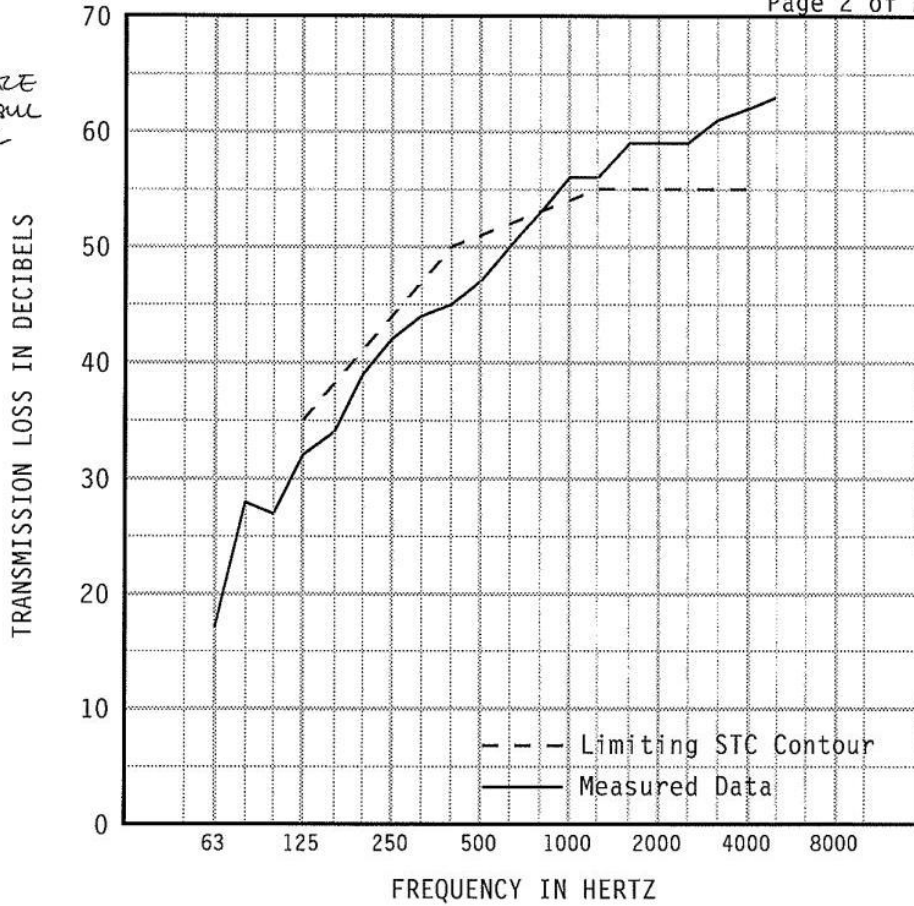

1/3 OCT BND CNTR FREQ	63	80	100	125	160	200	250	315	400	500
TL in dB	*17	*28	*27	*32	*34	*39	*42	*44	*45	*47
95% Confidence in dB deficiencies	1.42	1.92	2.07	1.47	0.89	0.76	0.80	0.52	0.36	0.38
				(3)	(4)	(2)	(2)	(3)	(5)	(4)
1/3 OCT BND CNTR FREQ	630	800	1000	1250	1600	2000	2500	3150	4000	5000
TL in dB	*50	*53	*56	*56	*59	*59	*59	61	62	63
95% Confidence in dB deficiencies	0.29	0.44	0.38	0.39	0.36	0.56	0.55	0.31	0.32	0.50
	(2)	(0)								

EWR	OITC	* Minimum estimate of transmission loss. Measurement limited by filler wall. Actual TL will be equal to or greater than value reported.	Specimen Area: 2.73 sq.ft.	STC
50	40		Temperature: 76.8 deg. F	51
			Relative Humidity: 32 %	(25)
			Test Date: 08 October 2013	

Report must be distributed in its entirety except with written authorization from Western Electro-Acoustic Laboratory

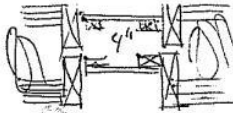

4" AIR SPACE
NO FILL
(2) 1/2" ALUM
PLATES

WESTERN ELECTRO-ACOUSTIC LABORATORY

Report No. TL13-609

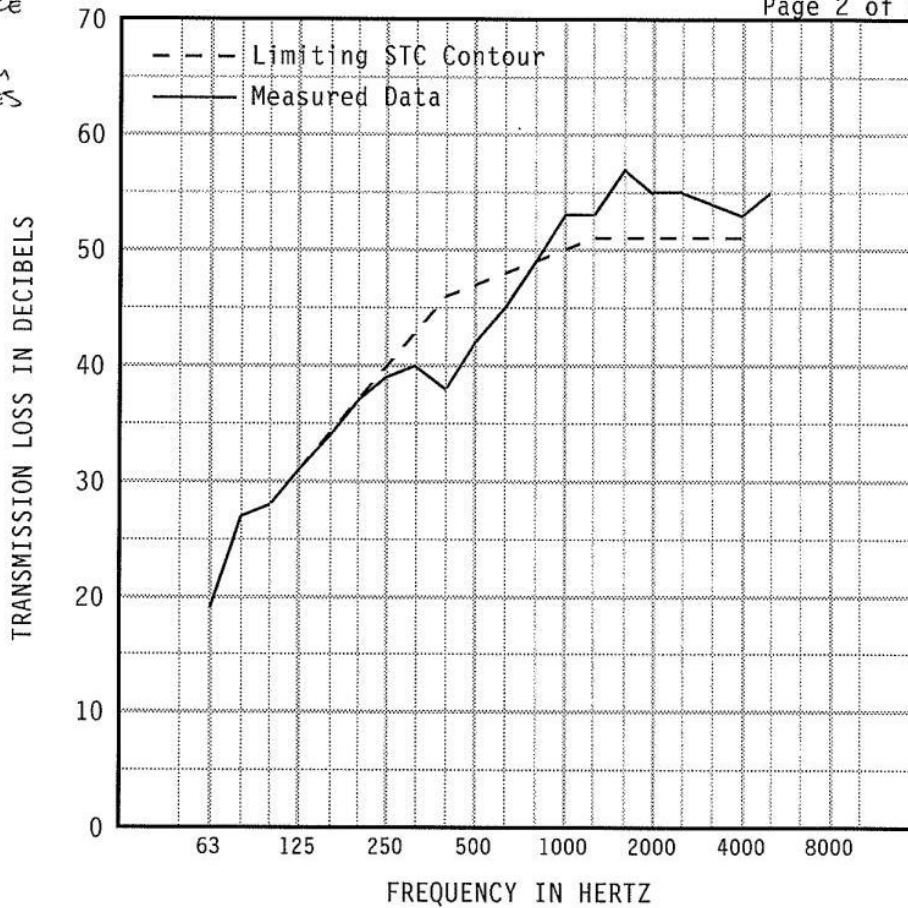

1/3 OCT BND CNTR FREQ	63	80	100	125	160	200	250	315	400	500
TL in dB	*19	*27	*28	*31	*34	*37	*39	40	38	42
95% Confidence in dB deficiencies	1.42	1.92	2.07	1.47 (0)	0.89 (0)	0.76 (0)	0.80 (1)	0.52 (3)	0.36 (8)	0.38 (5)
1/3 OCT BND CNTR FREQ	630	800	1000	1250	1600	2000	2500	3150	4000	5000
TL in dB	45	49	53	53	57	55	55	54	53	55
95% Confidence in dB deficiencies	0.29 (3)	0.44 (0)	0.38	0.39	0.36	0.56	0.55	0.31	0.32	0.50

EWR	OITC	* Minimum estimate of transmission loss. Measurement limited by filler wall. Actual TL will be equal to or greater than value reported.	Specimen Area: 2.73 sq.ft. Temperature: 77 deg. F Relative Humidity: 32 % Test Date: 08 October 2013	STC
47	39			47 (20)

Report must be distributed in its entirety except with written authorization from Western Electro-Acoustic Laboratory

SAME
AS 609
REDO
W/ NO LEAK

WESTERN ELECTRO-ACOUSTIC LABORATORY

Report No. TL13-610

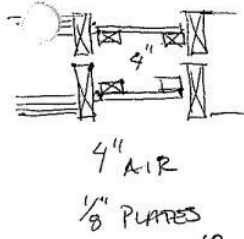

TRANSMISSION LOSS IN DECIBELS

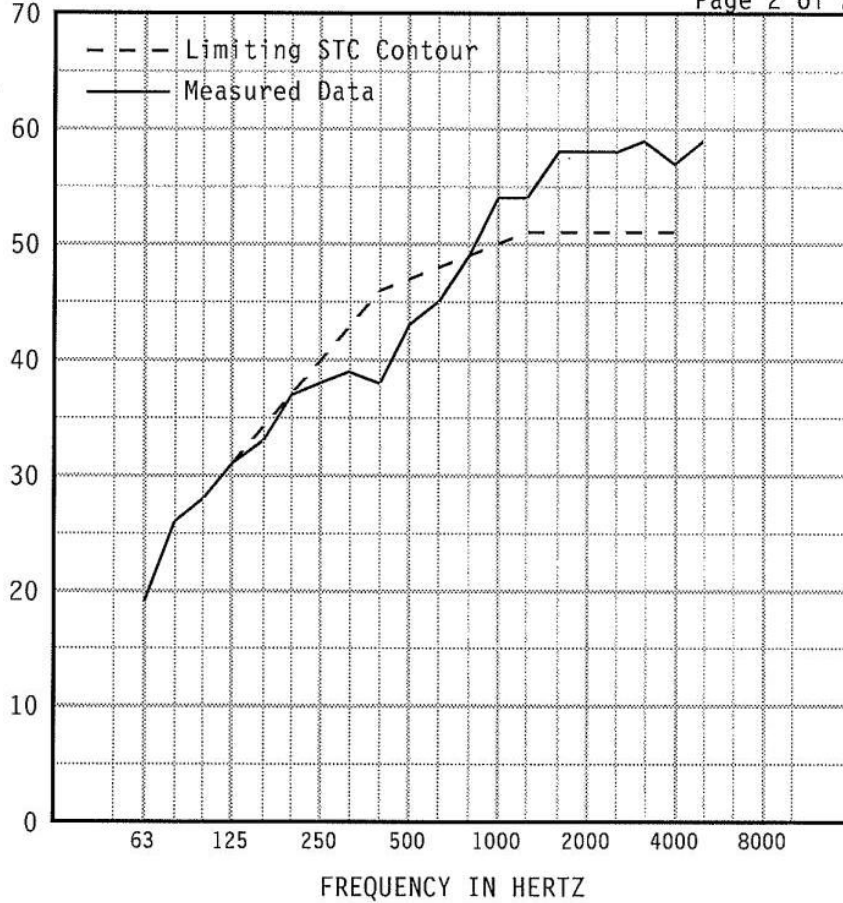

1/3 OCT BND CNTR FREQ	63	80	100	125	160	200	250	315	400	500
TL in dB	*19	*26	*28	*31	*33	*37	*38	39	38	43
95% Confidence in dB deficiencies	1.42	1.92	2.07	1.47	0.89	0.76	0.80	0.52	0.36	0.38
				(0)	(1)	(0)	(2)	(4)	(8)	(4)
1/3 OCT BND CNTR FREQ	630	800	1000	1250	1600	2000	2500	3150	4000	5000
TL in dB	45	49	54	54	58	*58	*58	59	57	59
95% Confidence in dB deficiencies	0.29	0.44	0.38	0.39	0.36	0.56	0.55	0.31	0.32	0.50
	(3)	(0)								

EWR	OITC	* Minimum estimate of transmission loss. Measurement limited by filler wall. Actual TL will be equal to or greater than value reported.	Specimen Area: 2.73 sq.ft. Temperature: 77.2 deg. F Relative Humidity: 33 % Test Date: 08 October 2013	STC
47	39			47 (22)

Report must be distributed in its entirety except with written authorization from Western Electro-Acoustic Laboratory

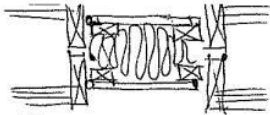

WESTERN ELECTRO-ACOUSTIC LABORATORY

Report No. TL13-611

9" AIR SPACE 70
 FILLED W/
 1 LAYER
 3" MIN WOOL

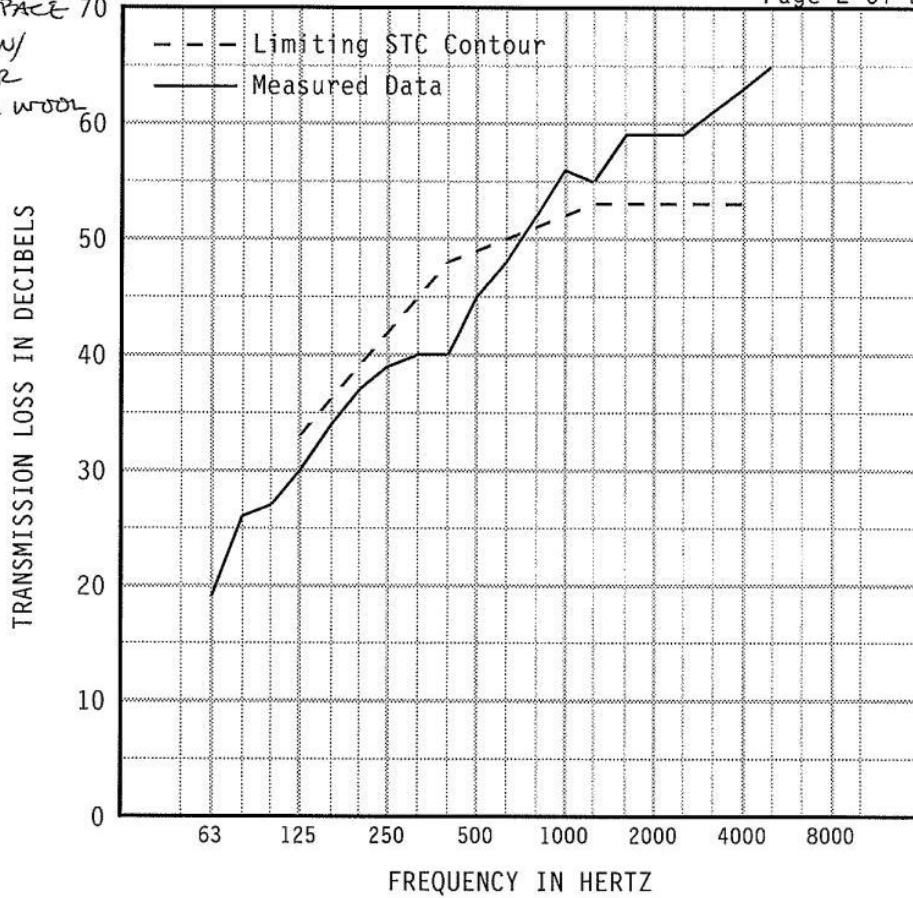

1/3 OCT BND CNTR	FREQ	63	80	100	125	160	200	250	315	400	500
TL in dB		*19	*26	*27	*30	*34	*37	*39	40	40	45
95% Confidence in dB deficiencies		1.42	1.92	2.07	1.47	0.89	0.76	0.80	0.52	0.36	0.38
					(3)	(2)	(2)	(3)	(5)	(8)	(4)
1/3 OCT BND CNTR	FREQ	630	800	1000	1250	1600	2000	2500	3150	4000	5000
TL in dB		48	*52	*56	55	*59	*59	*59	61	63	65
95% Confidence in dB deficiencies		0.29	0.44	0.38	0.39	0.36	0.56	0.55	0.31	0.32	0.50
		(2)									

EWR	OITC	* Minimum estimate of transmission loss. Measurement limited by filler wall. Actual TL will be equal to or greater than value reported.	Specimen Area: 2.73 sq.ft. Temperature: 77.2 deg. F Relative Humidity: 38 % Test Date: 08 October 2013	STC
48	39			49 (29)

Report must be distributed in its entirety except with written authorization from Western Electro-Acoustic Laboratory

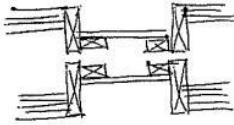

3' AIRSPACE
NO BAST

WESTERN ELECTRO-ACOUSTIC LABORATORY
Report No. TL13-612

8 oct 2013

Page 2 of 2

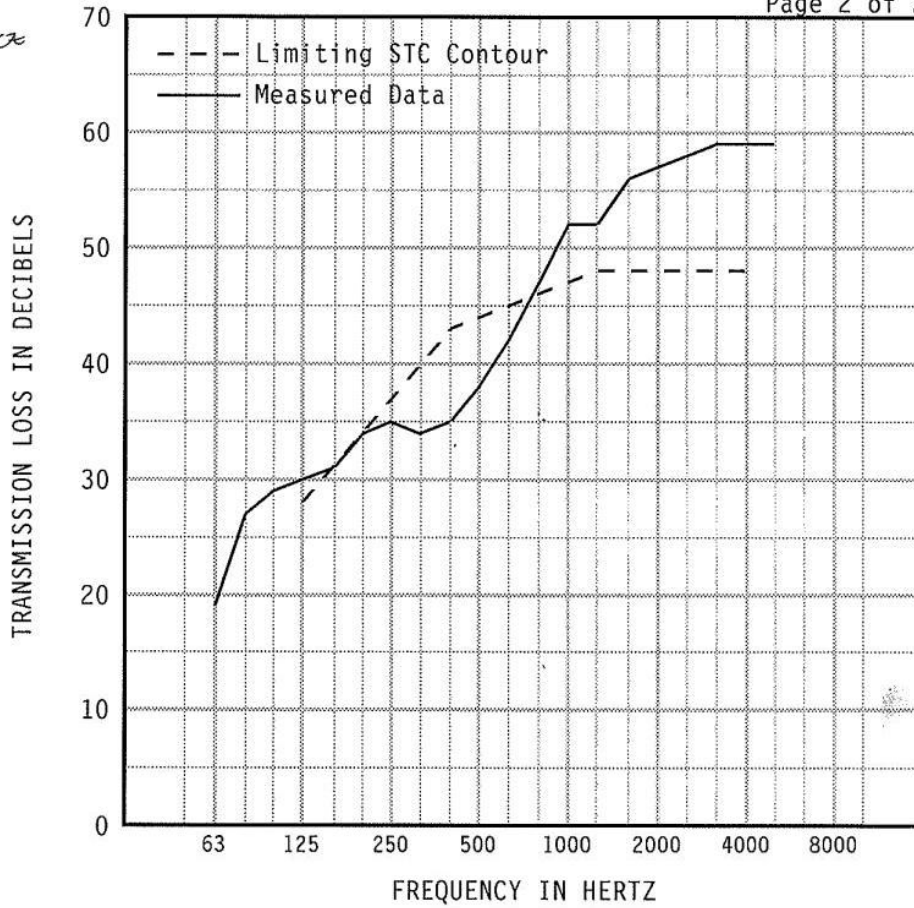

1/3 OCT BND CNTR FREQ	63	80	100	125	160	200	250	315	400	500
TL in dB	*19	*27	*29	*30	31	34	35	34	35	38
95% Confidence in dB deficiencies	1.42	1.92	2.07	1.47	0.89 (0)	0.76 (0)	0.80 (2)	0.52 (6)	0.36 (8)	0.38 (6)
1/3 OCT BND CNTR FREQ	630	800	1000	1250	1600	2000	2500	3150	4000	5000
TL in dB	42	47	52	52	56	*57	*58	59	59	59
95% Confidence in dB deficiencies	0.29 (3)	0.44	0.38	0.39	0.36	0.56	0.55	0.31	0.32	0.50

EWR	OITC	* Minimum estimate of transmission loss. Measurement limited by filler wall. Actual TL will be equal to or greater than value reported.	Specimen Area: 2.73 sq.ft. Temperature: 77.5 deg. F Relative Humidity: 47 % Test Date: 08 October 2013	STC
44	37			44 (25)

Report must be distributed in its entirety except with written authorization from Western Electro-Acoustic Laboratory

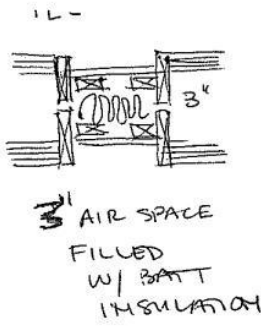

WESTERN ELECTRO-ACOUSTIC LABORATORY
Report No. TL13-613

8 Oct 2013

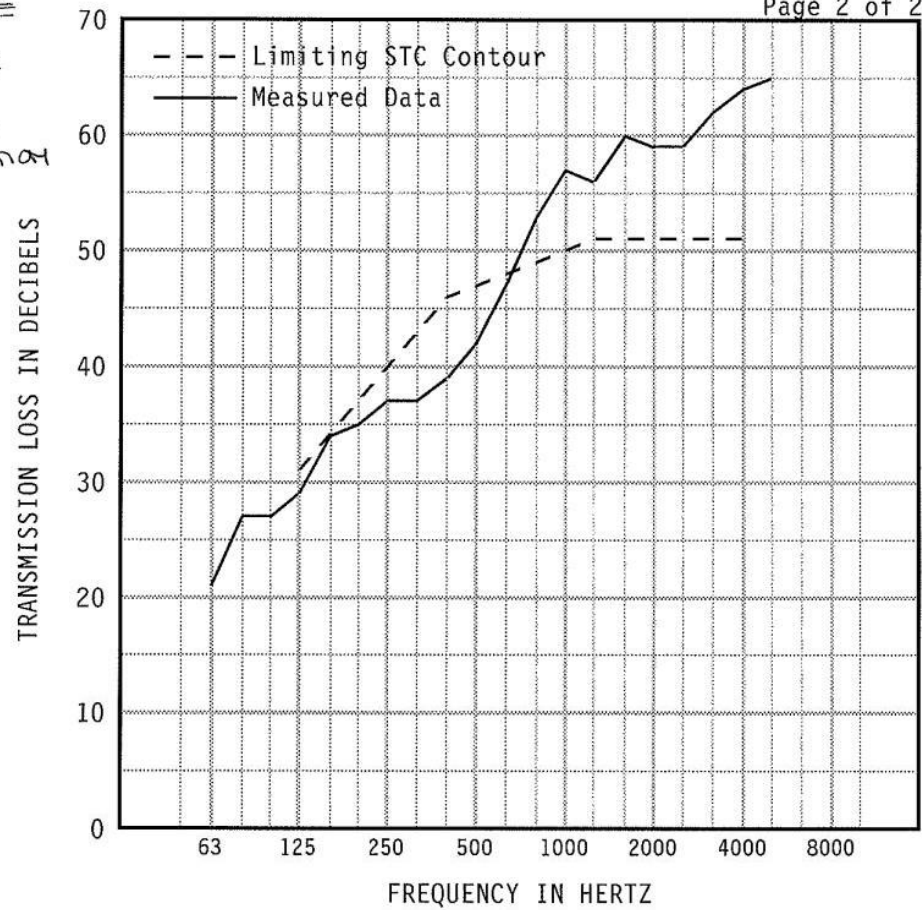

1/3 OCT BND CNTR FREQ	63	80	100	125	160	200	250	315	400	500
TL in dB	*21	*27	*27	*29	*34	35	37	37	39	42
95% Confidence in dB deficiencies	1.42	1.92	2.07	1.47 (2)	0.89 (0)	0.76 (2)	0.80 (3)	0.52 (6)	0.36 (7)	0.38 (5)
1/3 OCT BND CNTR FREQ	630	800	1000	1250	1600	2000	2500	3150	4000	5000
TL in dB	47	*53	*57	*56	*60	*59	*59	*62	64	65
95% Confidence in dB deficiencies	0.29 (1)	0.44	0.38	0.39	0.36	0.56	0.55	0.31	0.32	0.50

EWR	OITC	* Minimum estimate of transmission loss. Measurement limited by filler wall. Actual TL will be equal to or greater than value reported.	Specimen Area: 2.73 sq.ft. Temperature: 77.5 deg. F Relative Humidity: 48 % Test Date: 08 October 2013	STC
46	38			47 (26)

Report must be distributed in its entirety except with written authorization from Western Electro-Acoustic Laboratory

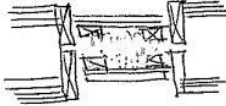

3" AIR
 1/8" ALUMINATE
 3/16" MLV LAYER

WESTERN ELECTRO-ACOUSTIC LABORATORY
 Report No. TL13-614

8 OCT 2013

Page 2 of 2

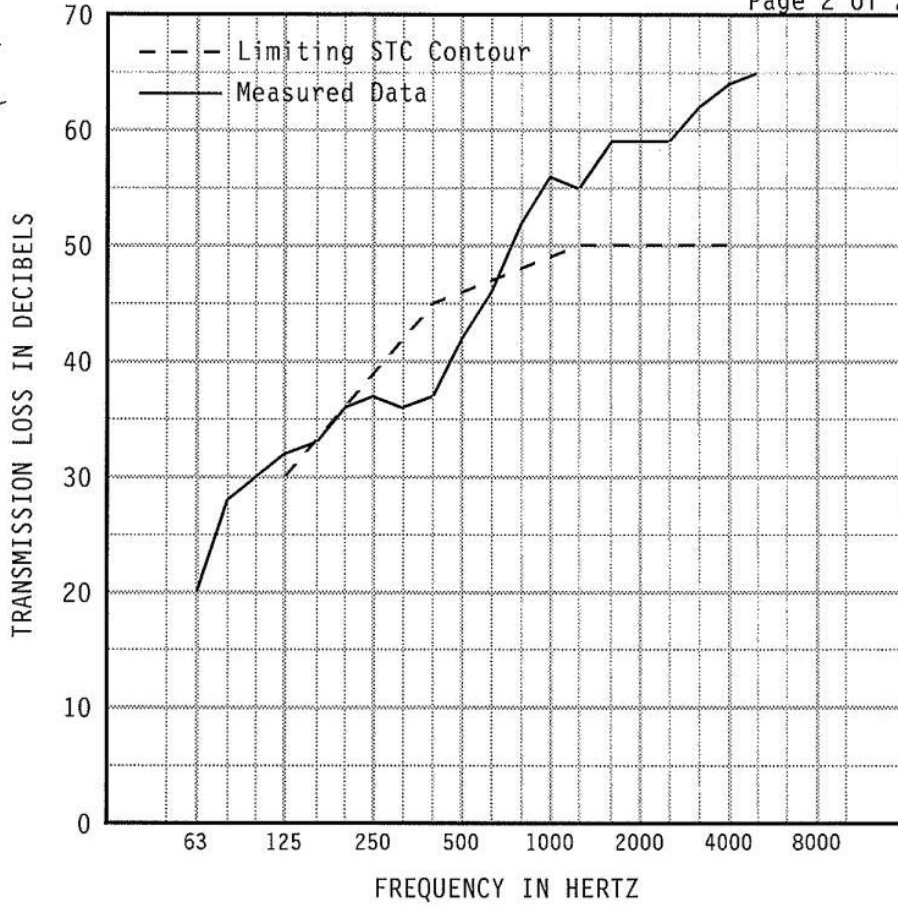

1/3 OCT BND CNTR FREQ	63	80	100	125	160	200	250	315	400	500
TL in dB	*20	*28	*30	*32	*33	*36	37	36	37	42
95% Confidence in dB deficiencies	1.42	1.92	2.07	1.47	0.89 (0)	0.76 (0)	0.80 (2)	0.52 (6)	0.36 (8)	0.38 (4)
1/3 OCT BND CNTR FREQ	630	800	1000	1250	1600	2000	2500	3150	4000	5000
TL in dB	46	*52	*56	55	*59	*59	*59	62	64	65
95% Confidence in dB deficiencies	0.29 (1)	0.44	0.38	0.39	0.36	0.56	0.55	0.31	0.32	0.50

EWR	OITC	* Minimum estimate of transmission loss. Measurement limited by filler wall. Actual TL will be equal to or greater than value reported. Specimen Area: 2.73 sq.ft. Temperature: 77.2 deg. F Relative Humidity: 44 % Test Date: 08 October 2013	STC
46	39		46 (21)

Report must be distributed in its entirety except with written authorization from Western Electro-Acoustic Laboratory

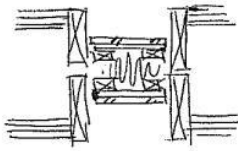

3" AIR
 BAST INSUL
 MLV 3/16"
 1/8" ALUM PLATE

WESTERN ELECTRO-ACOUSTIC LABORATORY

8 Oct 2013

Report No. TL13-615

Page 2 of 2

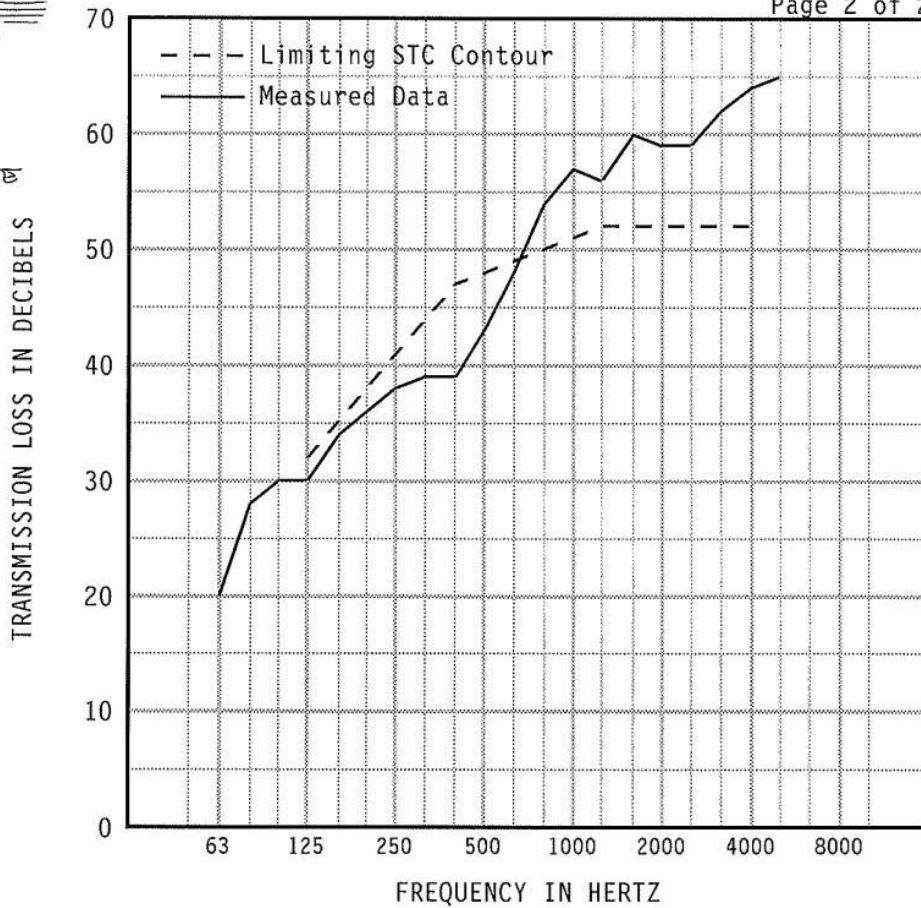

1/3 OCT BND CNTR	FREQ	63	80	100	125	160	200	250	315	400	500
TL in dB		*20	*28	*30	*30	*34	*36	*38	39	39	43
95% Confidence in dB deficiencies		1.42	1.92	2.07	1.47	0.89	0.76	0.80	0.52	0.36	0.38
					(2)	(1)	(2)	(3)	(5)	(8)	(5)
1/3 OCT BND CNTR	FREQ	630	800	1000	1250	1600	2000	2500	3150	4000	5000
TL in dB		48	*54	*57	*56	*60	*59	*59	*62	64	65
95% Confidence in dB deficiencies		0.29	0.44	0.38	0.39	0.36	0.56	0.55	0.31	0.32	0.50
		(1)									

EWR	OITC	* Minimum estimate of transmission loss. Measurement limited by filler wall. Actual TL will be equal to or greater than value reported.	Specimen Area: 2.73 sq.ft. Temperature: 77.5 deg. F Relative Humidity: 46 % Test Date: 08 October 2013	STC
47	39			48 (27)

Report must be distributed in its entirety except with written authorization from Western Electro-Acoustic Laboratory

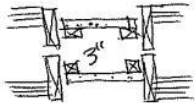

3" AIR SPACE
5/8" GYP BOARD

WESTERN ELECTRO-ACOUSTIC LABORATORY
Report No. TL13-616

1 OCT 2013
9:30 AM

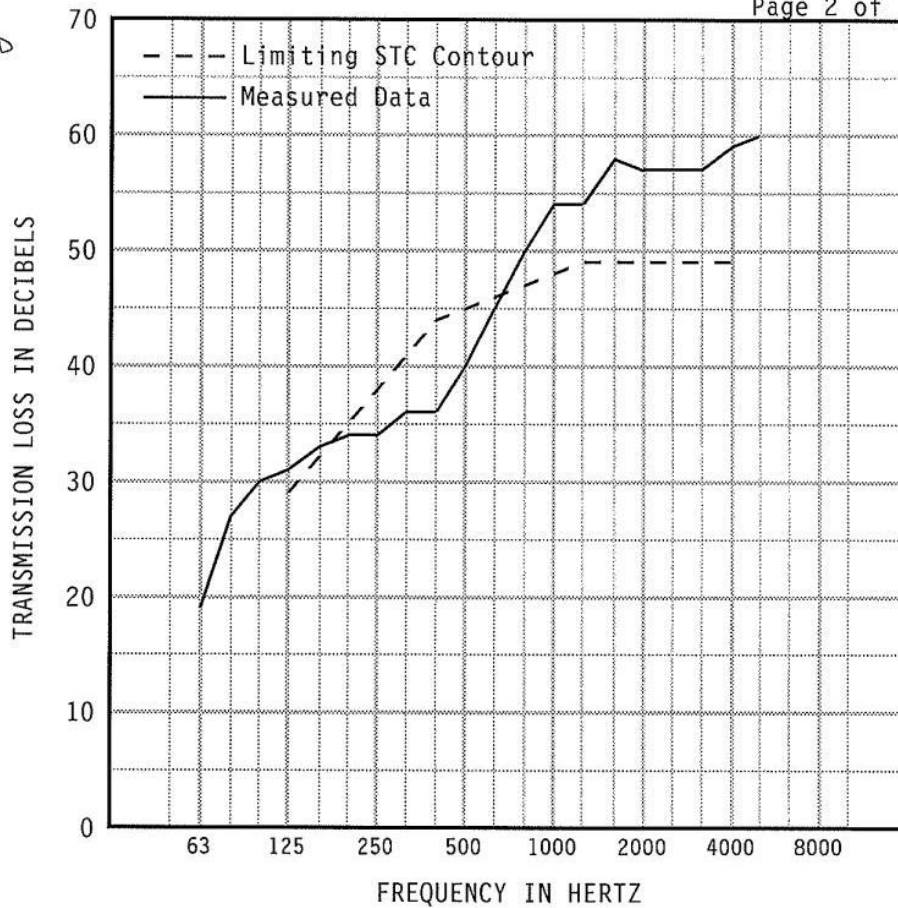

1/3 OCT BND CNTR FREQ	63	80	100	125	160	200	250	315	400	500
TL in dB	*19	*27	*30	*31	*33	34	34	36	36	40
95% Confidence in dB deficiencies	1.42	1.92	2.07	1.47	0.89	0.76 (1)	0.80 (4)	0.52 (5)	0.36 (8)	0.38 (5)
1/3 OCT BND CNTR FREQ	630	800	1000	1250	1600	2000	2500	3150	4000	5000
TL in dB	45	50	54	54	*58	*57	57	57	59	60
95% Confidence in dB deficiencies	0.29 (1)	0.44	0.38	0.39	0.36	0.56	0.55	0.31	0.32	0.50
EWR	OITC	* Minimum estimate of transmission loss. Measurement limited by filler wall. Actual TL will be equal to or greater than value reported.								STC
45	38	Specimen Area: 2.73 sq.ft. Temperature: 75.9 deg. F Relative Humidity: 35 % Test Date: 09 October 2013								45 (24)

Report must be distributed in its entirety except with written authorization from Western Electro-Acoustic Laboratory



3" AIRSPACE
5/8" GYP BOARD
PART INSULATION

WESTERN ELECTRO-ACOUSTIC LABORATORY
Report No. TL13-617

9 Oct 2013
10:30am?

Page 2 of 2

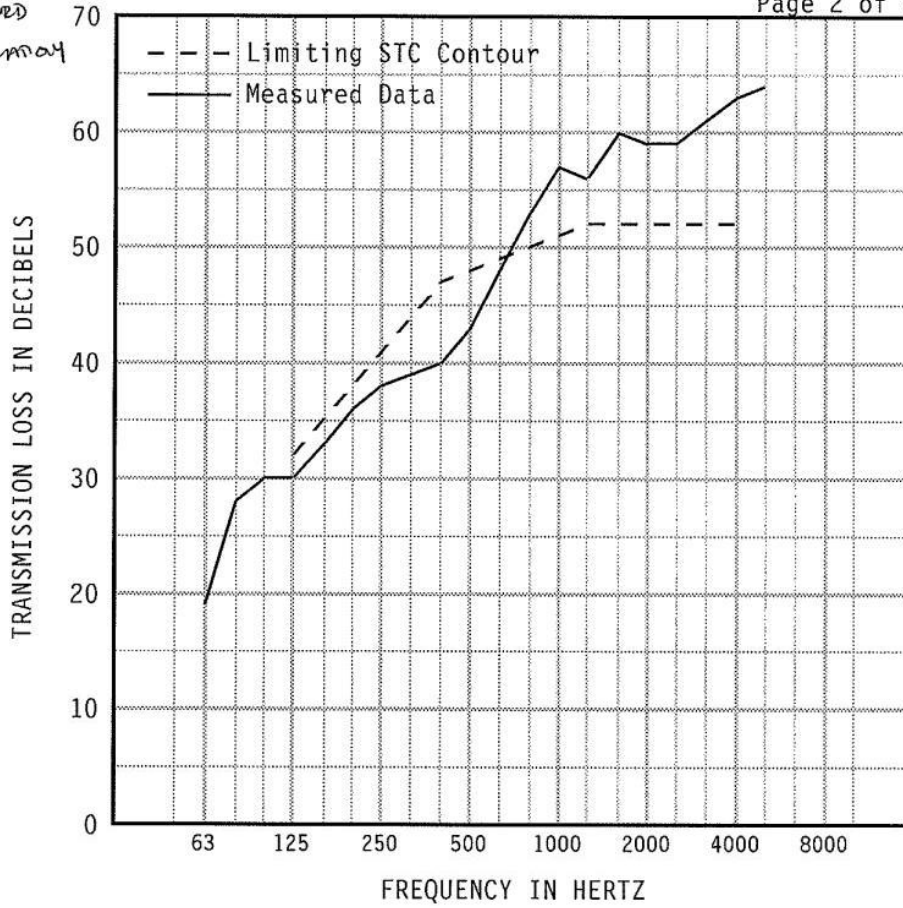

1/3 OCT BND CNTR	FREQ	63	80	100	125	160	200	250	315	400	500
TL in dB		*19	*28	*30	*30	*33	*36	38	39	40	43
95% Confidence in dB		1.42	1.92	2.07	1.47	0.89	0.76	0.80	0.52	0.36	0.38
deficiencies					(2)	(2)	(2)	(3)	(5)	(7)	(5)
1/3 OCT BND CNTR	FREQ	630	800	1000	1250	1600	2000	2500	3150	4000	5000
TL in dB		48	*53	*57	*56	*60	*59	*59	61	63	64
95% Confidence in dB		0.29	0.44	0.38	0.39	0.36	0.56	0.55	0.31	0.32	0.50
deficiencies		(1)									

EWR	OITC	* Minimum estimate of transmission loss. Measurement limited by filler wall. Actual TL will be equal to or greater than value reported.	Specimen Area: 2.73 sq.ft. Temperature: 75.9 deg. F Relative Humidity: 35 % Test Date: 09 October 2013	STC
47	39			48 (27)

Report must be distributed in its entirety except with written authorization from Western Electro-Acoustic Laboratory

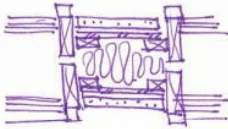

WESTERN ELECTRO-ACOUSTIC LABORATORY
Report No. TL13-618

9 Oct 2013
11:35 am

5/8" GYP BOARD
MLV 3/16"
1/8" ALUM PLATE
MIN WOOL
INSULATION

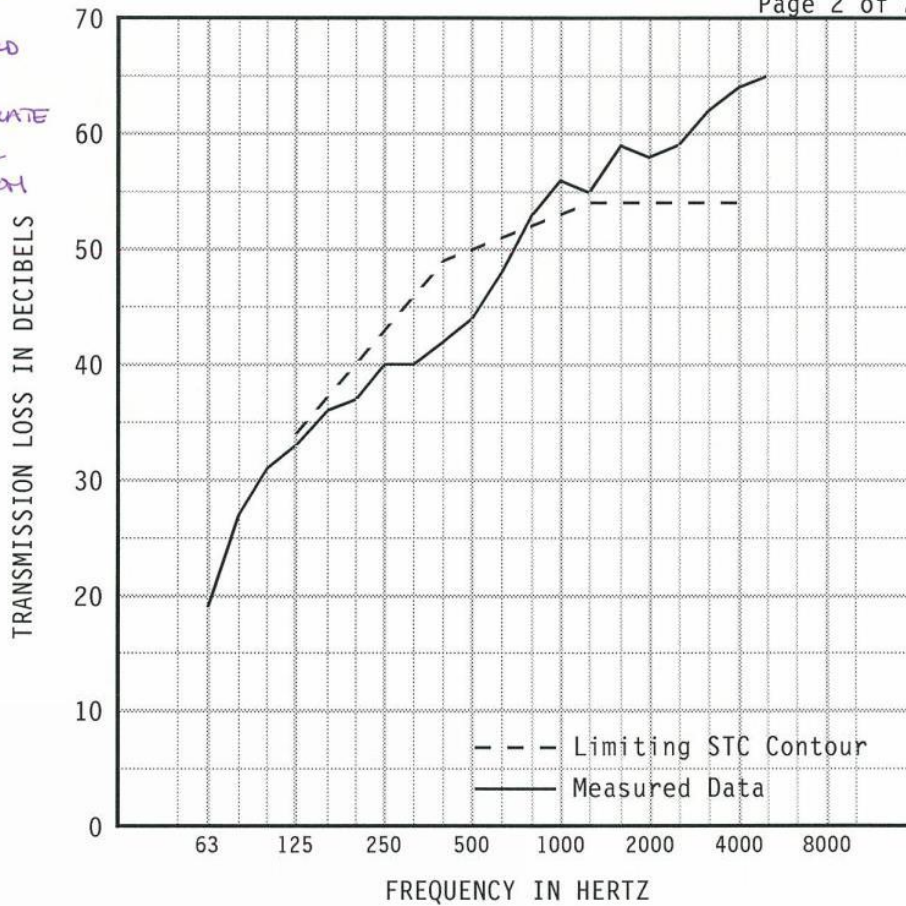

1/3 OCT BND CNTR FREQ	63	80	100	125	160	200	250	315	400	500
TL in dB	*19	*27	*31	*33	*36	*37	*40	*40	42	44
95% Confidence in dB deficiencies	1.42	1.92	2.07	1.47	0.89	0.76	0.80	0.52	0.36	0.38
				(1)	(1)	(3)	(3)	(6)	(7)	(6)
1/3 OCT BND CNTR FREQ	630	800	1000	1250	1600	2000	2500	3150	4000	5000
TL in dB	48	*53	*56	55	*59	*58	*59	62	64	65
95% Confidence in dB deficiencies	0.29	0.44	0.38	0.39	0.36	0.56	0.55	0.31	0.32	0.50
	(3)									

EWR	OITC	* Minimum estimate of transmission loss. Measurement limited by filler wall. Actual TL will be equal to or greater than value reported.	Specimen Area: 2.73 sq.ft. Temperature: 75.7 deg. F Relative Humidity: 33 % Test Date: 09 October 2013	STC
49	41			50 (30)

Report must be distributed in its entirety except with written authorization from Western Electro-Acoustic Laboratory

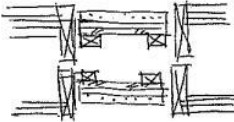

5/8" GYP
MLV 3/16"
ALUM PLATE
NO FILL

WESTERN ELECTRO-ACOUSTIC LABORATORY
Report No. TL13-619

7 OCT 2013
12:30 pm

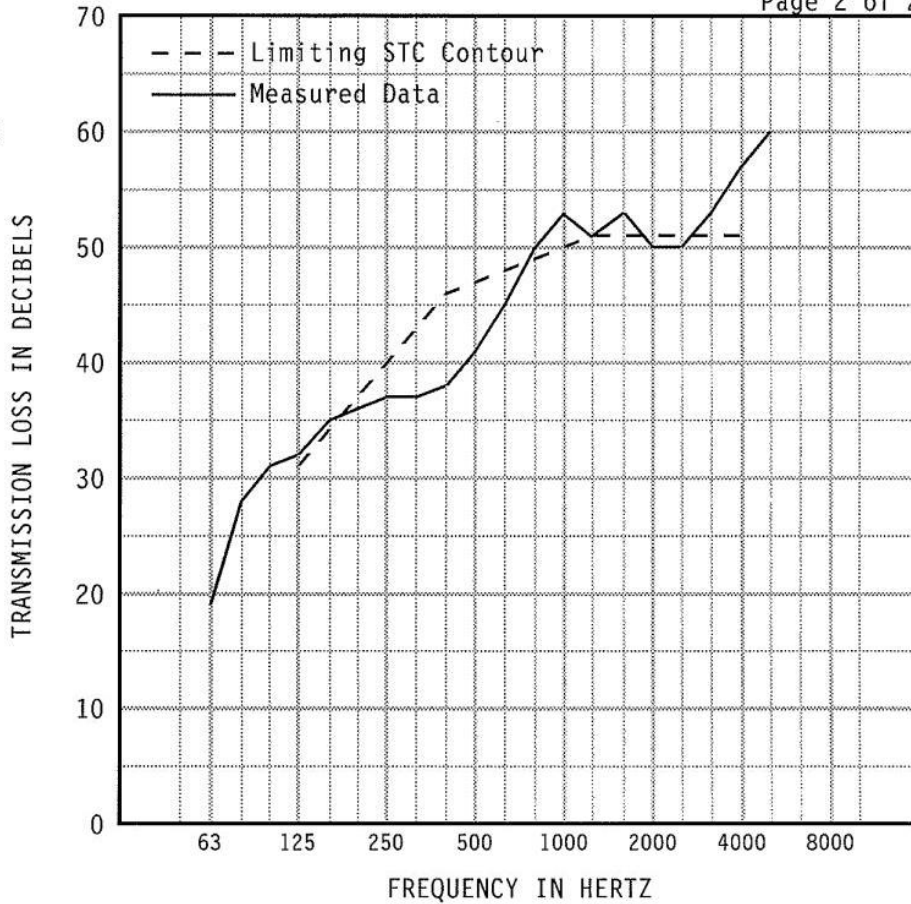

1/3 OCT BND CNTR	FREQ	63	80	100	125	160	200	250	315	400	500
TL in dB		*19	*28	*31	*32	*35	*36	37	37	38	41
95% Confidence in dB deficiencies		1.42	1.92	2.07	1.47	0.89	0.76	0.80	0.52	0.36	0.38
							(1)	(3)	(6)	(8)	(6)
1/3 OCT BND CNTR	FREQ	630	800	1000	1250	1600	2000	2500	3150	4000	5000
TL in dB		45	50	53	51	53	50	50	53	57	60
95% Confidence in dB deficiencies		0.29	0.44	0.38	0.39	0.36	0.56	0.55	0.31	0.32	0.50
		(3)			(0)		(1)	(1)			

EWR	OITC	* Minimum estimate of transmission loss. Measurement limited by filler wall. Actual TL will be equal to or greater than value reported.	Specimen Area: 2.73 sq.ft. Temperature: 76.5 deg. F Relative Humidity: 33 % Test Date: 09 October 2013	STC
46	39			47
				(29)

Report must be distributed in its entirety except with written authorization from Western Electro-Acoustic Laboratory

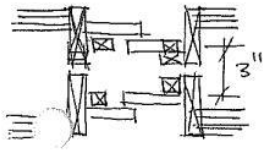

WESTERN ELECTRO-ACOUSTIC LABORATORY

Report No. TL13-620

NO SEAL
 NO MIN WOOL
 2" overlap
 1/4" GAP b/w overlap
 3" airspace
 minimum
 GYPBD

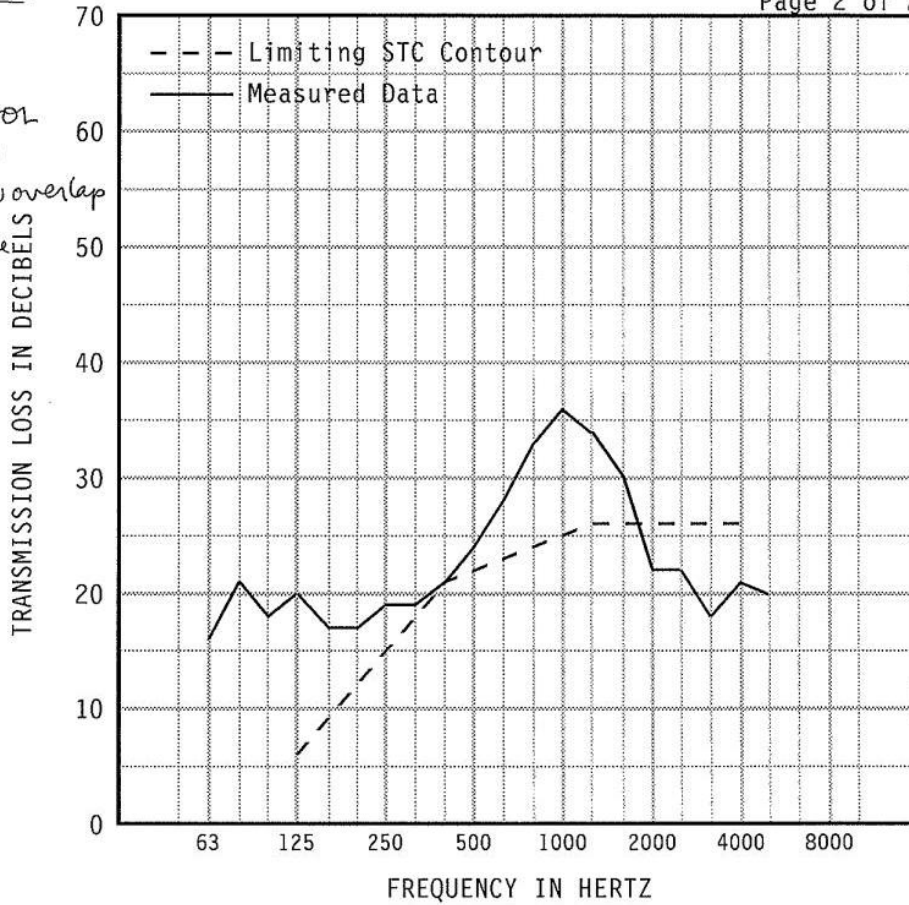

1/3 OCT BND CNTR	FREQ	63	80	100	125	160	200	250	315	400	500
TL in dB		*16	*21	18	20	17	17	19	19	21	24
95% Confidence in dB deficiencies		1.42	1.92	2.07	1.47	0.89	0.76	0.80	0.52	0.36	0.38
										(0)	
1/3 OCT BND CNTR	FREQ	630	800	1000	1250	1600	2000	2500	3150	4000	5000
TL in dB		28	33	36	34	30	22	22	18	21	20
95% Confidence in dB deficiencies		0.29	0.44	0.38	0.39	0.36	0.56	0.55	0.31	0.32	0.50
							(4)	(4)	(8)	(5)	

EWR	OITC	* Minimum estimate of transmission loss. Measurement limited by filler wall. Actual TL will be equal to or greater than value reported.	Specimen Area: 2.73 sq.ft. Temperature: 75 deg. F Relative Humidity: 32 % Test Date: 09 October 2013	STC
27	22			22 (21)

Report must be distributed in its entirety except with written authorization from Western Electro-Acoustic Laboratory

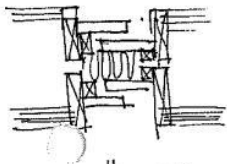

3" WIDE
NO SEALS
1/4" GAP
5/8" GYP WALL
BATT INSUL

WESTERN ELECTRO-ACOUSTIC LABORATORY

Report No. TL13-621

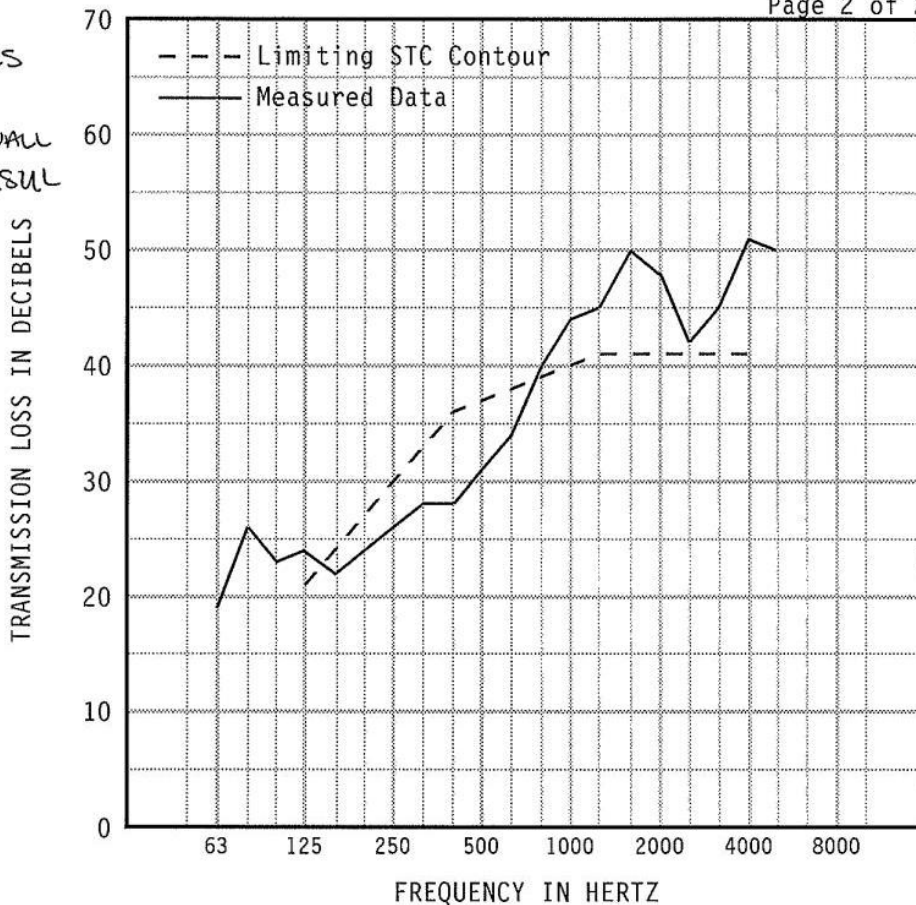

1/3 OCT BND CNTR FREQ	63	80	100	125	160	200	250	315	400	500
TL in dB	*19	*26	23	24	22	24	26	28	28	31
95% Confidence in dB deficiencies	1.42	1.92	2.07	1.47	0.89	0.76	0.80	0.52	0.36	0.38
					(2)	(3)	(4)	(5)	(8)	(6)
1/3 OCT BND CNTR FREQ	630	800	1000	1250	1600	2000	2500	3150	4000	5000
TL in dB	34	40	44	45	50	48	42	45	51	50
95% Confidence in dB deficiencies	0.29	0.44	0.38	0.39	0.36	0.56	0.55	0.31	0.32	0.50
	(4)									

EWR	OITC	* Minimum estimate of transmission loss. Measurement limited by filler wall. Actual TL will be equal to or greater than value reported.	Specimen Area: 2.73 sq. ft. Temperature: 76.1 deg. F Relative Humidity: 32 % Test Date: 09 October 2013	STC
36	30			37 (32)

Report must be distributed in its entirety except with written authorization from Western Electro-Acoustic Laboratory

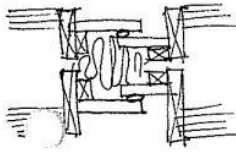

WESTERN ELECTRO-ACOUSTIC LABORATORY

Report No. TL13-622

SEALS
ADDED
5" GYP BD
BATT
INSULATION

TRANSMISSION LOSS IN DECIBELS

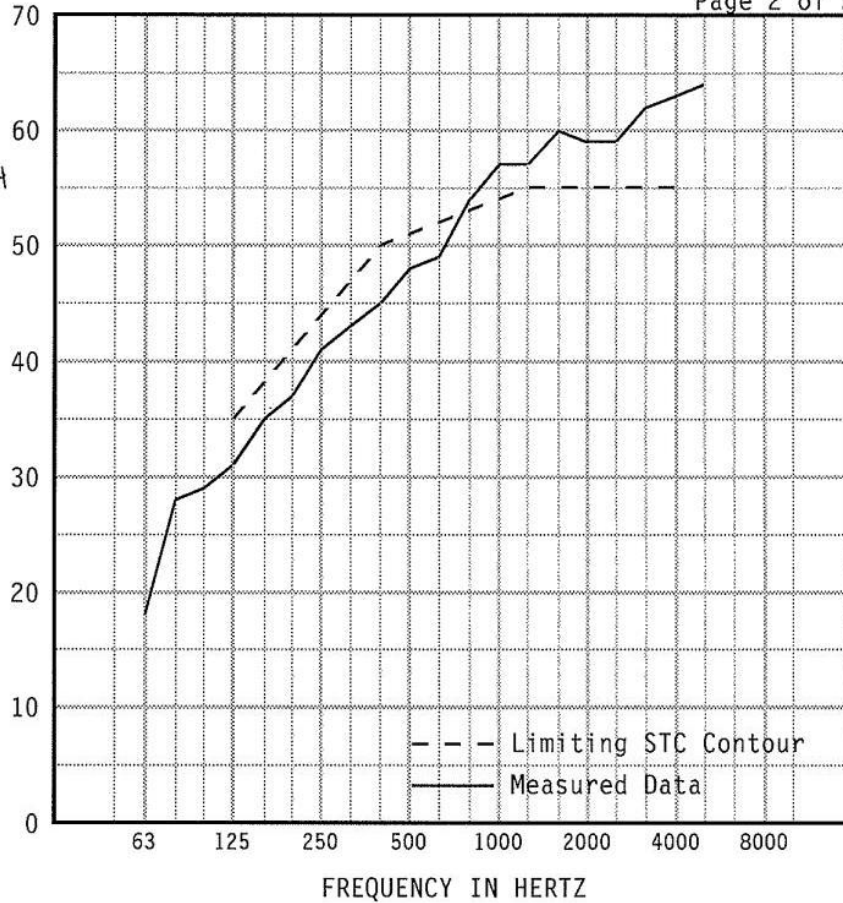

1/3 OCT BND CNTR FREQ	63	80	100	125	160	200	250	315	400	500
TL in dB	*18	*28	*29	*31	*35	*37	*41	*43	*45	*48
95% Confidence in dB deficiencies	1.42	1.92	2.07	1.47 (4)	0.89 (3)	0.76 (4)	0.80 (3)	0.52 (4)	0.36 (5)	0.38 (3)
1/3 OCT BND CNTR FREQ	630	800	1000	1250	1600	2000	2500	3150	4000	5000
TL in dB	*49	*54	*57	*57	*60	*59	*59	62	63	64
95% Confidence in dB deficiencies	0.29 (3)	0.44	0.38	0.39	0.36	0.56	0.55	0.31	0.32	0.50

EWR	OITC
50	40

* Minimum estimate of transmission loss. Measurement limited by filler wall. Actual TL will be equal to or greater than value reported.

Specimen Area: 2.73 sq.ft.
Temperature: 74.8 deg. F
Relative Humidity: 32 %
Test Date: 09 October 2013

STC
51 (29)

Report must be distributed in its entirety except with written authorization from Western Electro-Acoustic Laboratory

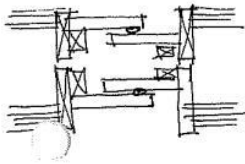

BULB SEALS
 1/4" GAP
 5/8" GYP BD
 2" overlap
 *LEAKY!

WESTERN ELECTRO-ACOUSTIC LABORATORY
 Report No. TL13-623

9 OCT 2013

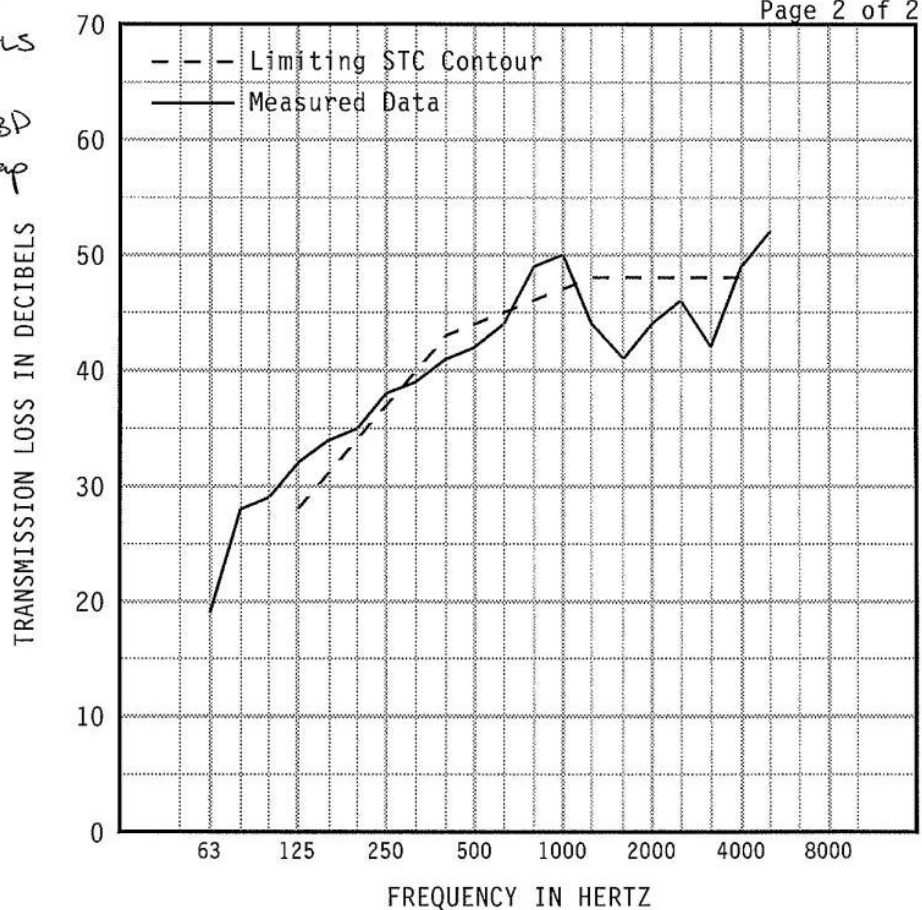

1/3 OCT BND CNTR	FREQ	63	80	100	125	160	200	250	315	400	500
TL in dB		*19	*28	*29	*32	*34	*35	38	39	41	42
95% Confidence in dB		1.42	1.92	2.07	1.47	0.89	0.76	0.80	0.52	0.36	0.38
deficiencies									(1)	(2)	(2)
1/3 OCT BND CNTR	FREQ	630	800	1000	1250	1600	2000	2500	3150	4000	5000
TL in dB		44	49	50	44	41	44	46	42	49	52
95% Confidence in dB		0.29	0.44	0.38	0.39	0.36	0.56	0.55	0.31	0.32	0.50
deficiencies		(1)			(4)	(7)	(4)	(2)	(6)		

EWR	OITC	* Minimum estimate of transmission loss. Measurement limited by filler wall. Actual TL will be equal to or greater than value reported.	Specimen Area: 2.73 sq.ft. Temperature: 74.7 deg. F Relative Humidity: 32 % Test Date: 09 October 2013	STC
46	39			44 (29)

Report must be distributed in its entirety except with written authorization from Western Electro-Acoustic Laboratory

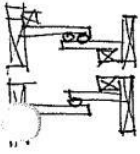

WESTERN ELECTRO-ACOUSTIC LABORATORY

Report No. TL13-624

2 BULB
SEALS
ON RECEIVER

1/8" 5Y PBD
NO BATT

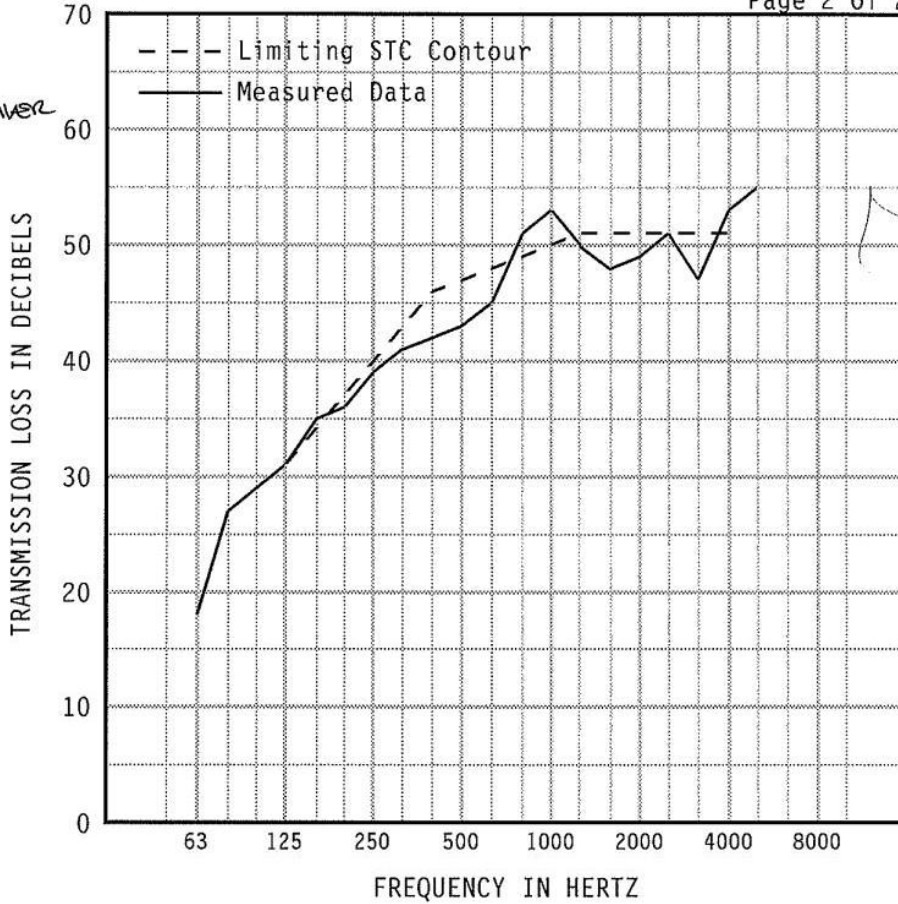

1/3 OCT BND CNTR FREQ	63	80	100	125	160	200	250	315	400	500
TL in dB	*18	*27	*29	*31	*35	*36	*39	*41	42	43
95% Confidence in dB deficiencies	1.42	1.92	2.07	1.47	0.89	0.76	0.80	0.52	0.36	0.38
				(0)		(1)	(1)	(2)	(4)	(4)
1/3 OCT BND CNTR FREQ	630	800	1000	1250	1600	2000	2500	3150	4000	5000
TL in dB	45	51	53	50	48	49	51	47	53	55
95% Confidence in dB deficiencies	0.29	0.44	0.38	0.39	0.36	0.56	0.55	0.31	0.32	0.50
	(3)			(1)	(3)	(2)	(0)	(4)		

EWR	OITC	* Minimum estimate of transmission loss. Measurement limited by filler wall. Actual TL will be equal to or greater than value reported.	Specimen Area: 2.73 sq.ft.	STC
48	40		Temperature: 75.6 deg. F	47
			Relative Humidity: 30 %	(25)
			Test Date: 10 October 2013	

Report must be distributed in its entirety except with written authorization from Western Electro-Acoustic Laboratory

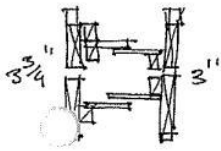

1/8" ALUM PLATES
NO SEALS
NO BATT
1/4" gap

WESTERN ELECTRO-ACOUSTIC LABORATORY

Report No. TL13-625

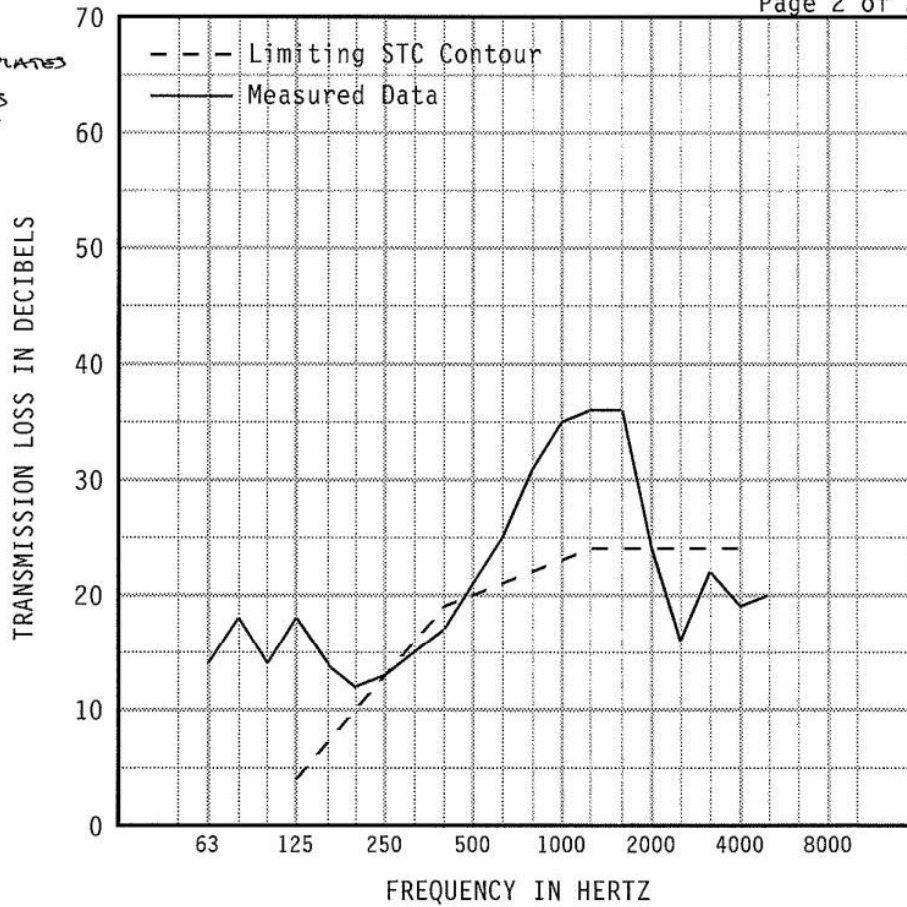

1/3 OCT BND CNTR FREQ	63	80	100	125	160	200	250	315	400	500
TL in dB	*14	18	14	18	14	12	13	15	17	21
95% Confidence in dB deficiencies	1.42	1.92	2.07	1.47	0.89	0.76	0.80 (0)	0.52 (1)	0.36 (2)	0.38
1/3 OCT BND CNTR FREQ	630	800	1000	1250	1600	2000	2500	3150	4000	5000
TL in dB	25	31	35	36	36	24	16	22	19	20
95% Confidence in dB deficiencies	0.29	0.44	0.38	0.39	0.36	0.56 (0)	0.55 (8)	0.31 (2)	0.32 (5)	0.50

EWR	OITC
24	19

* Minimum estimate of transmission loss. Measurement limited by filler wall. Actual TL will be equal to or greater than value reported.

Specimen Area: 2.73 sq.ft.
Temperature: 75.9 deg. F
Relative Humidity: 32 %
Test Date: 10 October 2013

STC
20
(18)

Report must be distributed in its entirety except with written authorization from Western Electro-Acoustic Laboratory

10 Oct 2013

WESTERN ELECTRO-ACOUSTIC LABORATORY

Report No. TL13-626

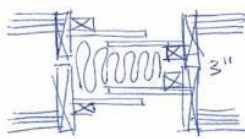

1/8" alum plates
1/4" gap
no seals
batl insul
in cavity

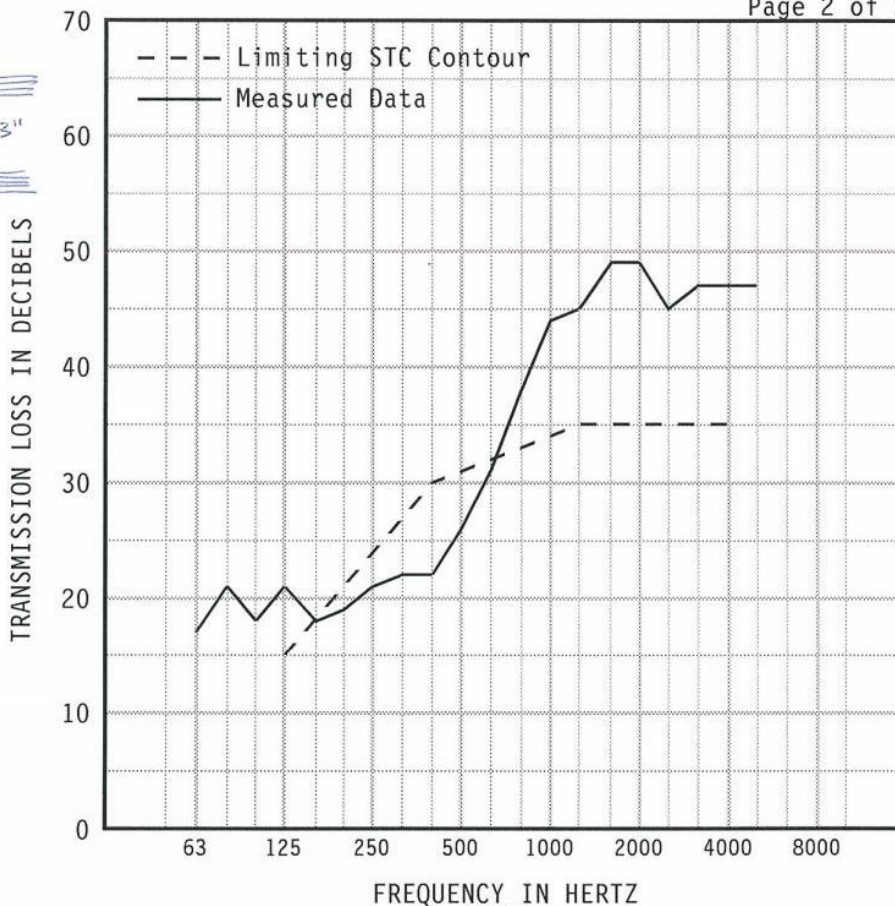

1/3 OCT BND CNTR FREQ	63	80	100	125	160	200	250	315	400	500
TL in dB	*17	*21	18	21	18	19	21	22	22	26
95% Confidence in dB deficiencies	1.42	1.92	2.07	1.47	0.89 (0)	0.76 (2)	0.80 (3)	0.52 (5)	0.36 (8)	0.38 (5)
1/3 OCT BND CNTR FREQ	630	800	1000	1250	1600	2000	2500	3150	4000	5000
TL in dB	31	38	44	45	49	49	45	47	47	47
95% Confidence in dB deficiencies	0.29 (1)	0.44	0.38	0.39	0.36	0.56	0.55	0.31	0.32	0.50

EWR	OITC	* Minimum estimate of transmission loss. Measurement limited by filler wall. Actual TL will be equal to or greater than value reported. Specimen Area: 2.73 sq.ft. Temperature: 76.1 deg. F Relative Humidity: 32 % Test Date: 10 October 2013	STC
31	25		31 (24)

Report must be distributed in its entirety except with written authorization from Western Electro-Acoustic Laboratory

10 OCT 2013

WESTERN ELECTRO-ACOUSTIC LABORATORY

Report No. TL13-627

Page 2 of 2



1/8" alum plates
bulb seals
w/ batt

TRANSMISSION LOSS IN DECIBELS

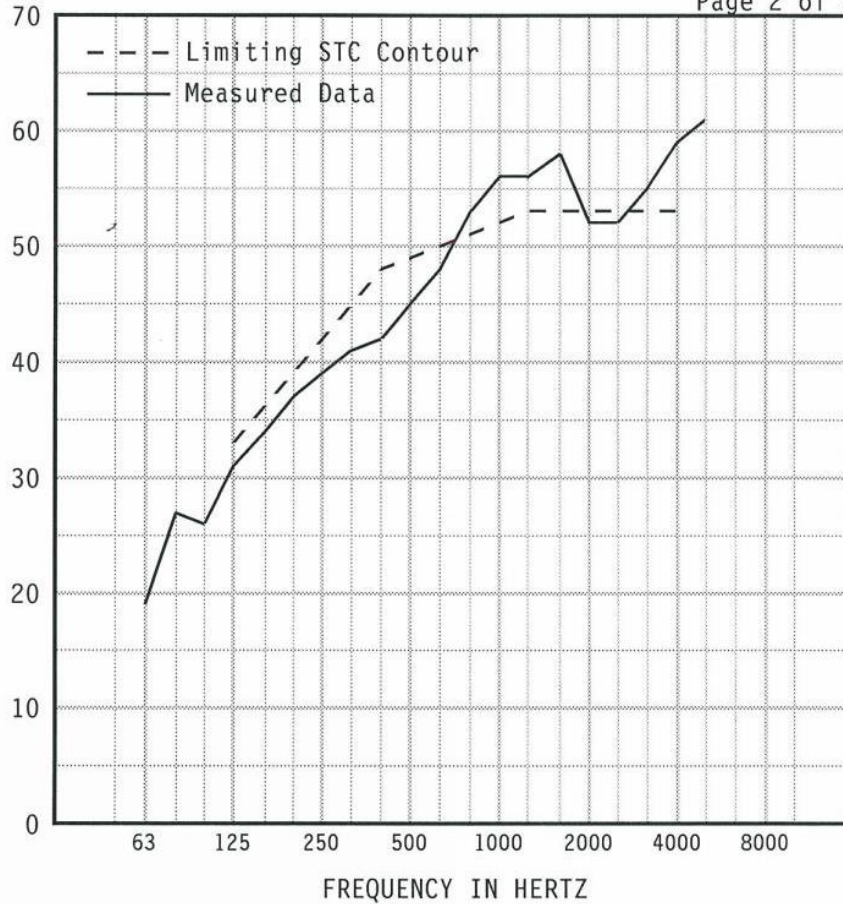

1/3 OCT BND CNTR FREQ	63	80	100	125	160	200	250	315	400	500
TL in dB	*19	*27	*26	*31	*34	*37	*39	*41	42	45
95% Confidence in dB deficiencies	1.42	1.92	2.07	1.47	0.89	0.76	0.80	0.52	0.36	0.38
				(2)	(2)	(2)	(3)	(4)	(6)	(4)
1/3 OCT BND CNTR FREQ	630	800	1000	1250	1600	2000	2500	3150	4000	5000
TL in dB	*48	*53	*56	*56	*58	52	52	55	59	61
95% Confidence in dB deficiencies	0.29	0.44	0.38	0.39	0.36	0.56	0.55	0.31	0.32	0.50
	(2)					(1)	(1)			

EWR	OITC	* Minimum estimate of transmission loss. Measurement limited by filler wall. Actual TL will be equal to or greater than value reported.	Specimen Area: 2.73 sq.ft.	STC
48	39		Temperature: 76.1 deg. F	49
			Relative Humidity: 32 %	(27)
			Test Date: 10 October 2013	

Report must be distributed in its entirety except with written authorization from Western Electro-Acoustic Laboratory

WESTERN ELECTRO-ACOUSTIC LABORATORY

Report No. TL13-628

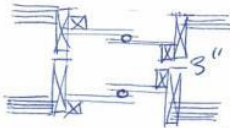

*Seals only
no batt
1/8" alum
sheets*

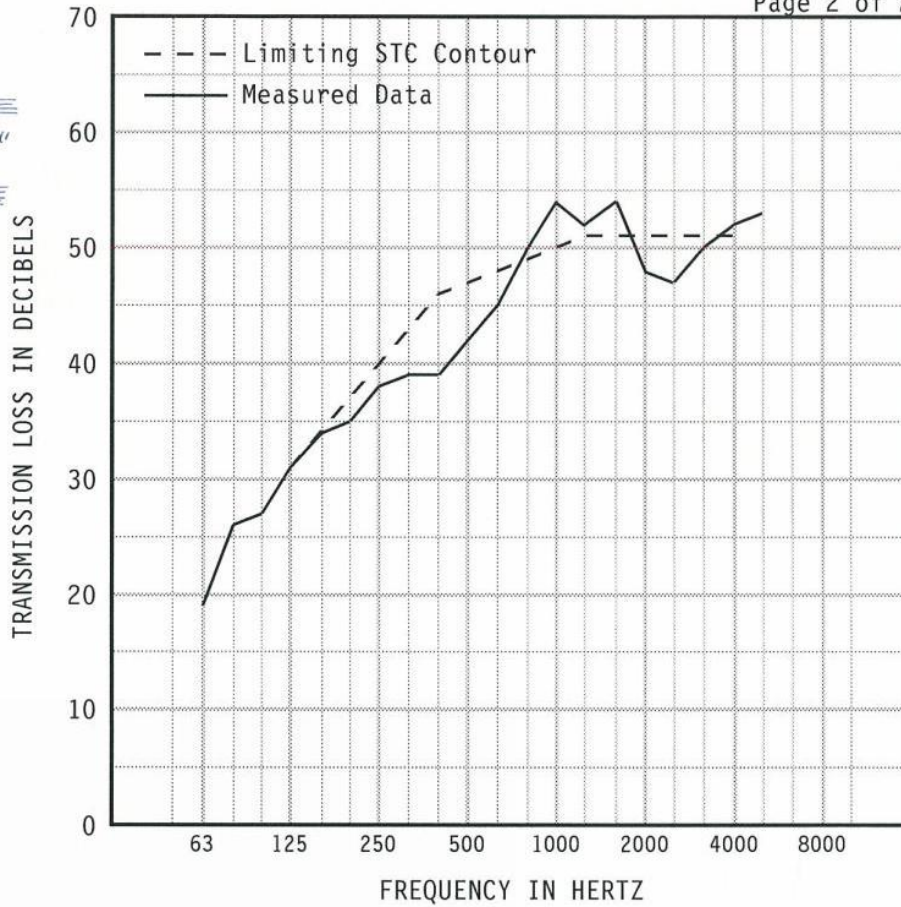

1/3 OCT BND CNTR FREQ	63	80	100	125	160	200	250	315	400	500
TL in dB	*19	*26	*27	*31	*34	*35	38	39	39	42
95% Confidence in dB deficiencies	1.42	1.92	2.07	1.47 (0)	0.89 (0)	0.76 (2)	0.80 (2)	0.52 (4)	0.36 (7)	0.38 (5)
1/3 OCT BND CNTR FREQ	630	800	1000	1250	1600	2000	2500	3150	4000	5000
TL in dB	45	50	54	52	54	48	47	50	52	53
95% Confidence in dB deficiencies	0.29 (3)	0.44	0.38	0.39	0.36	0.56 (3)	0.55 (4)	0.31 (1)	0.32	0.50

EWR	OITC
47	39

* Minimum estimate of transmission loss. Measurement limited by filler wall. Actual TL will be equal to or greater than value reported.

Specimen Area: 2.73 sq.ft.
Temperature: 76.3 deg. F
Relative Humidity: 32 %
Test Date: 10 October 2013

STC
47 (31)

Report must be distributed in its entirety except with written authorization from Western Electro-Acoustic Laboratory

WESTERN ELECTRO-ACOUSTIC LABORATORY

Report No. TL13-629

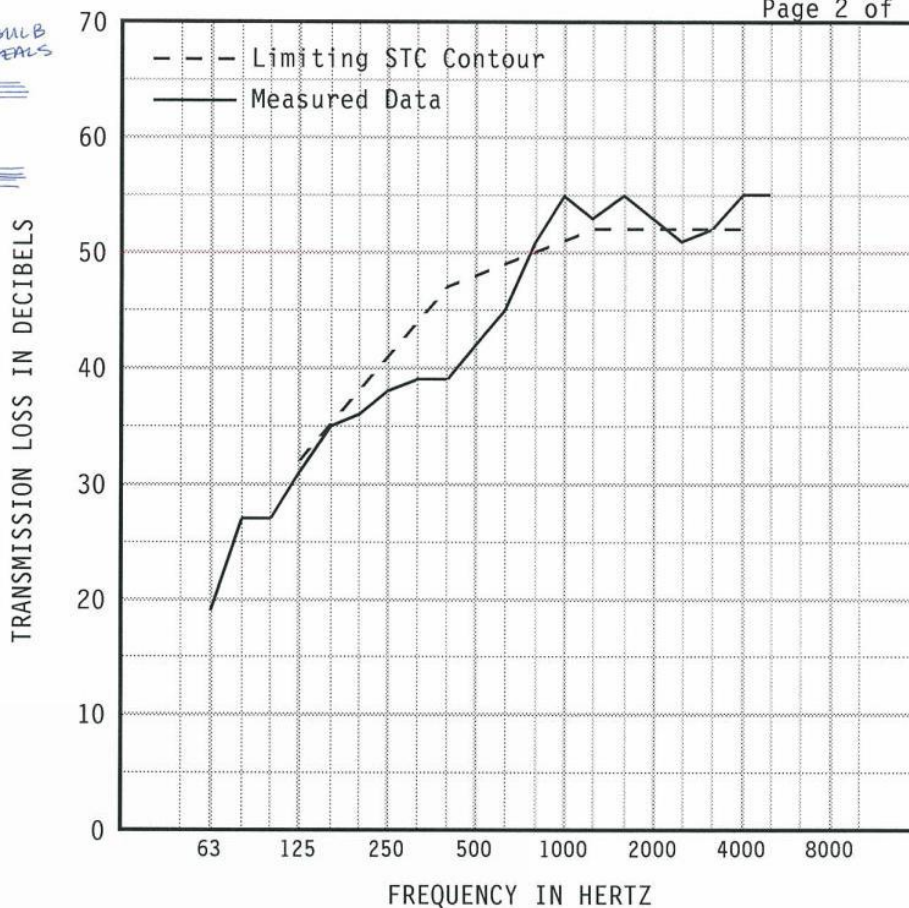
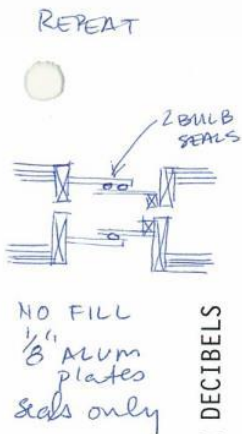

1/3 OCT BND CNTR FREQ	63	80	100	125	160	200	250	315	400	500
TL in dB	*19	*27	*27	*31	*35	*36	38	39	39	42
95% Confidence in dB deficiencies	1.42	1.92	2.07	1.47 (1)	0.89 (0)	0.76 (2)	0.80 (3)	0.52 (5)	0.36 (8)	0.38 (6)
1/3 OCT BND CNTR FREQ	630	800	1000	1250	1600	2000	2500	3150	4000	5000
TL in dB	45	51	*55	53	55	53	51	52	55	55
95% Confidence in dB deficiencies	0.29 (4)	0.44	0.38	0.39	0.36	0.56	0.55 (1)	0.31 (0)	0.32	0.50

EWR	OITC	* Minimum estimate of transmission loss. Measurement limited by filler wall. Actual TL will be equal to or greater than value reported. Specimen Area: 2.73 sq.ft. Temperature: 76.3 deg. F Relative Humidity: 32 % Test Date: 10 October 2013	STC
47	39		48 (30)

Report must be distributed in its entirety except with written authorization from Western Electro-Acoustic Laboratory

MILLION-MATS ONLY

WESTERN ELECTRO-ACOUSTIC LABORATORY

Report No. TL13-630

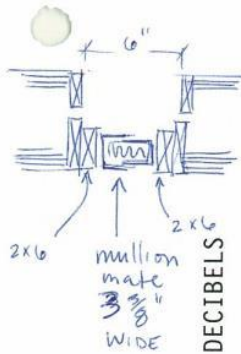

TRANSMISSION LOSS IN DECIBELS

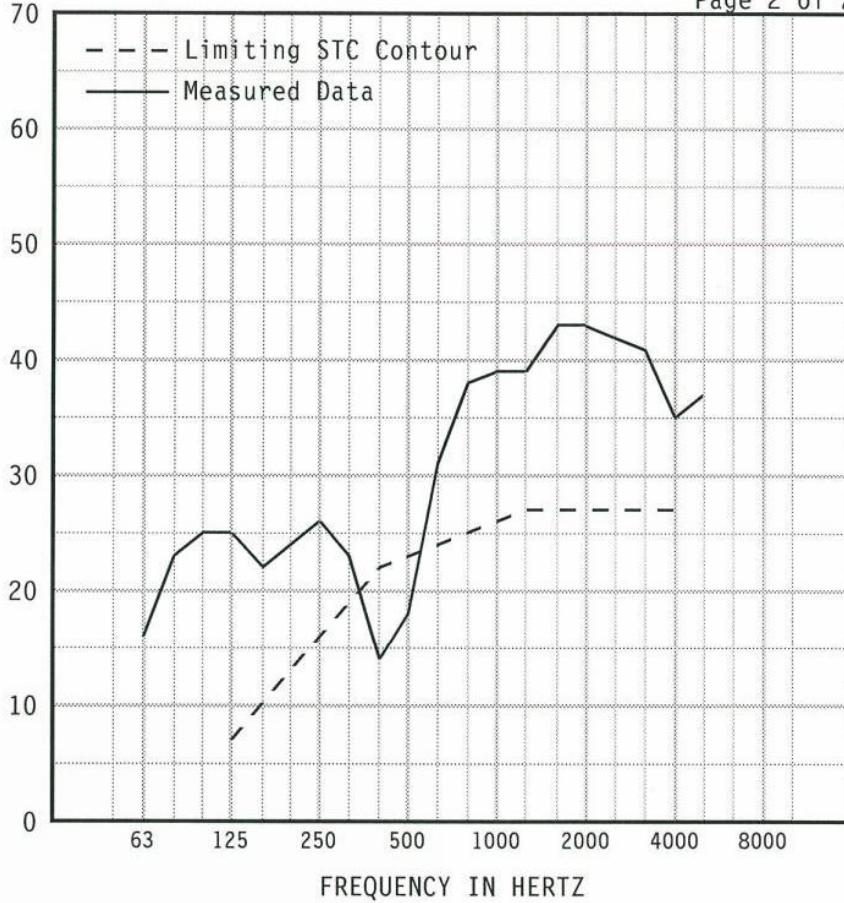

1/3 OCT BND CNTR	FREQ	63	80	100	125	160	200	250	315	400	500
TL in dB		*16	*23	*25	*25	22	24	26	23	14	18
95% Confidence in dB deficiencies		1.42	1.92	2.07	1.47	0.89	0.76	0.80	0.52	0.36 (8)	0.38 (5)
1/3 OCT BND CNTR	FREQ	630	800	1000	1250	1600	2000	2500	3150	4000	5000
TL in dB		31	38	39	39	43	43	42	41	35	37
95% Confidence in dB deficiencies		0.29	0.44	0.38	0.39	0.36	0.56	0.55	0.31	0.32	0.50

EWR	OITC	* Minimum estimate of transmission loss. Measurement limited by filler wall. Actual TL will be equal to or greater than value reported. Specimen Area: 1.41 sq.ft. Temperature: 75.7 deg. F Relative Humidity: 31 % Test Date: 10 October 2013	STC
31	23		23 (13)

Report must be distributed in its entirety except with written authorization from Western Electro-Acoustic Laboratory

11 OCT 2013

WESTERN ELECTRO-ACOUSTIC LABORATORY

Report No. TL13-631

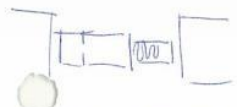

MULTI-MATE
+ BARE MULTI-MATE
net seal

Page 2 of 2

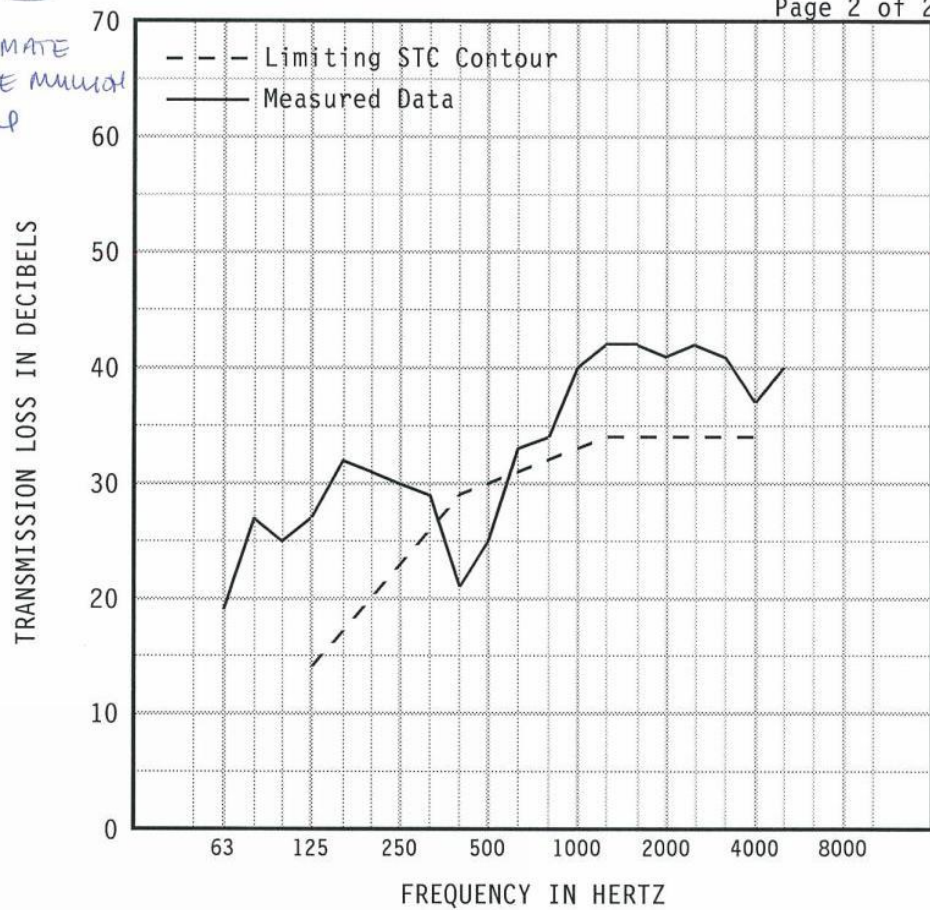

1/3 OCT BND CNTR	FREQ	63	80	100	125	160	200	250	315	400	500
TL in dB		*19	*27	25	27	32	31	30	29	21	25
95% Confidence in dB deficiencies		1.42	1.92	2.07	1.47	0.89	0.76	0.80	0.52	0.36 (8)	0.38 (5)
1/3 OCT BND CNTR	FREQ	630	800	1000	1250	1600	2000	2500	3150	4000	5000
TL in dB		33	34	40	42	42	41	42	41	37	40
95% Confidence in dB deficiencies		0.29	0.44	0.38	0.39	0.36	0.56	0.55	0.31	0.32	0.50

EWR	OITC	* Minimum estimate of transmission loss. Measurement limited by filler wall. Actual TL will be equal to or greater than value reported.	Specimen Area: 4.22 sq.ft. Temperature: 74.5 deg. F Relative Humidity: 32 % Test Date: 11 October 2013	STC
36	29			30 (13)

Report must be distributed in its entirety except with written authorization from Western Electro-Acoustic Laboratory



WESTERN ELECTRO-ACOUSTIC LABORATORY

Report No. TL13-632

MULTI-MATE
+
BEST
MULTI-MATE
wet seal

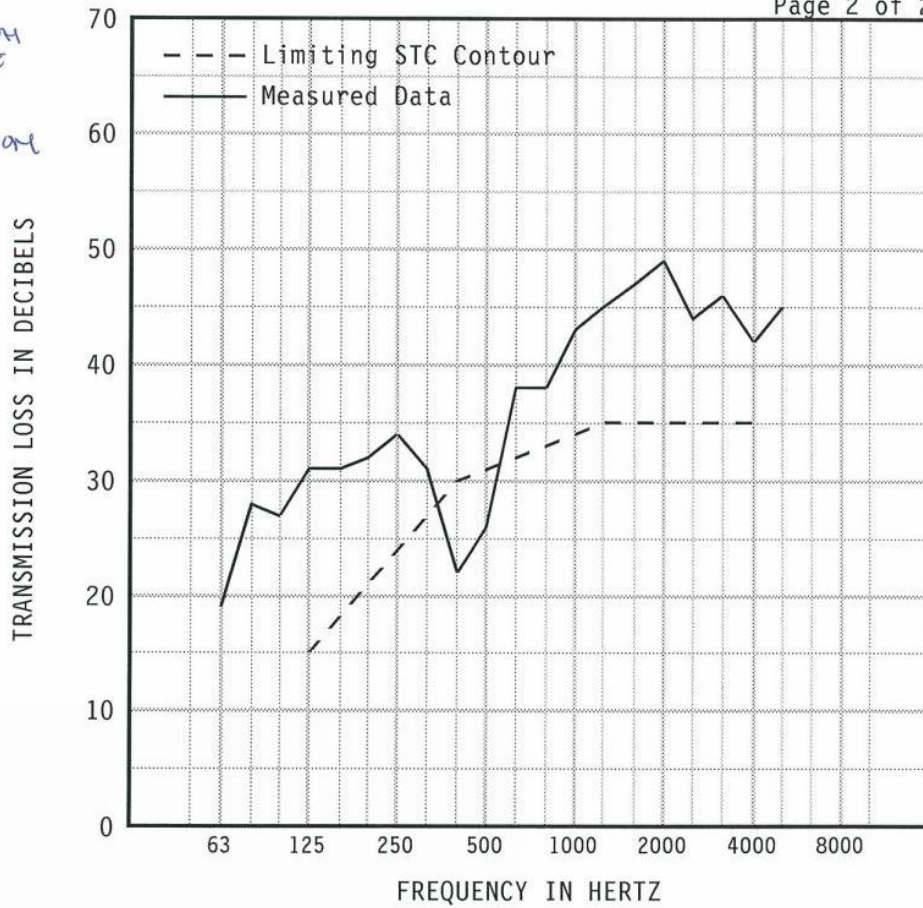

1/3 OCT BND CNTR	FREQ	63	80	100	125	160	200	250	315	400	500
TL in dB		*19	*28	27	*31	31	32	34	31	22	26
95% Confidence in dB deficiencies		1.42	1.92	2.07	1.47	0.89	0.76	0.80	0.52	0.36 (8)	0.38 (5)
1/3 OCT BND CNTR	FREQ	630	800	1000	1250	1600	2000	2500	3150	4000	5000
TL in dB		38	38	43	45	47	49	44	46	42	45
95% Confidence in dB deficiencies		0.29	0.44	0.38	0.39	0.36	0.56	0.55	0.31	0.32	0.50

EWR	OITC	* Minimum estimate of transmission loss. Measurement limited by filler wall. Actual TL will be equal to or greater than value reported.	Specimen Area: 4.22 sq.ft. Temperature: 75.2 deg. F Relative Humidity: 32 % Test Date: 11 October 2013	STC
38	31			31 (13)

Report must be distributed in its entirety except with written authorization from Western Electro-Acoustic Laboratory

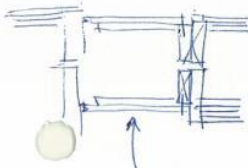

mullit over
totally
isolated
leaves

WESTERN ELECTRO-ACOUSTIC LABORATORY

Report No. TL13-633

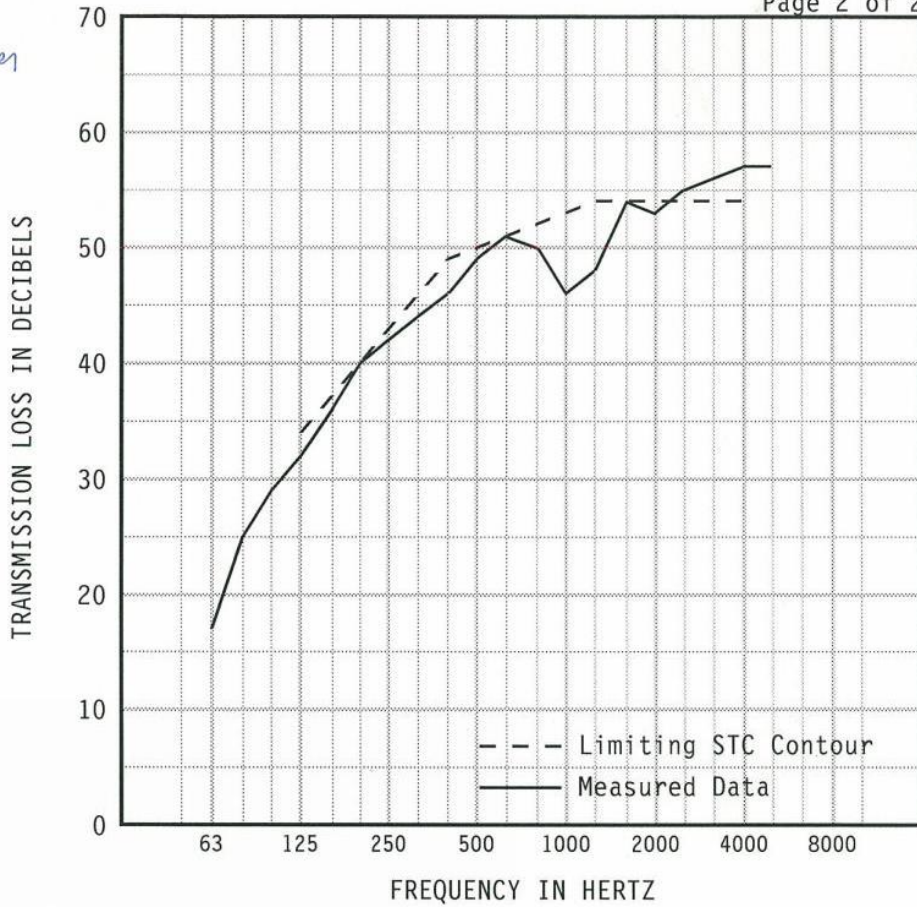

1/3 OCT BND CNTR	FREQ	63	80	100	125	160	200	250	315	400	500
TL in dB		*17	*25	*29	*32	*36	*40	*42	*44	*46	*49
95% Confidence in dB		1.42	1.92	2.07	1.47	0.89	0.76	0.80	0.52	0.36	0.38
deficiencies					(2)	(1)	(0)	(1)	(2)	(3)	(1)
1/3 OCT BND CNTR	FREQ	630	800	1000	1250	1600	2000	2500	3150	4000	5000
TL in dB		*51	50	46	48	54	53	55	56	57	57
95% Confidence in dB		0.29	0.44	0.38	0.39	0.36	0.56	0.55	0.31	0.32	0.50
deficiencies		(0)	(2)	(7)	(6)	(0)	(1)				

EWR	OITC	* Minimum estimate of transmission loss. Measurement limited by filler wall. Actual TL will be equal to or greater than value reported.	Specimen Area: 2.81 sq.ft. Temperature: 75.6 deg. F Relative Humidity: 30 % Test Date: 11 October 2013	STC
50	40			50 (26)

Report must be distributed in its entirety except with written authorization from Western Electro-Acoustic Laboratory

B.5 PHASE 3 WEAL TEST RESULTS

WEAL TL	STC	Area (SF)	Specimen (Connection)	Edge Seal	Notes
TL14-167	42	2.92 sf	STC 52 Mullion - overclad (gyp+MLV) and filled (MLV pillows)	backer rod + wet seal	overclad screwed into mullion
TL14-168	37	2.92 sf	STC 38 Mullion - filled MLV pillows	backer rod + wet seal	3 non-puttied holes
TL14-169	32	2.92 sf	STC 36 Mullion - bare and hollow	Backer rod + wet seal	3 non-puttied holes
TL14-170	32	2.92 sf	STC 36 Mullion - bare and hollow	Backer rod + wet seal	all holes puttied
TL14-171	32	2.92 sf	STC 36 Mullion - bare and hollow	Backer rod + wet seal	all holes puttied Receiver chamber removed

TABLE B- 5: PHASE 3, WEAL TEST NUMBERS, AREA AND DESCRIPTION

STC 52
MULLION



WESTERN ELECTRO-ACOUSTIC LABORATORY

Report No. TL14-167

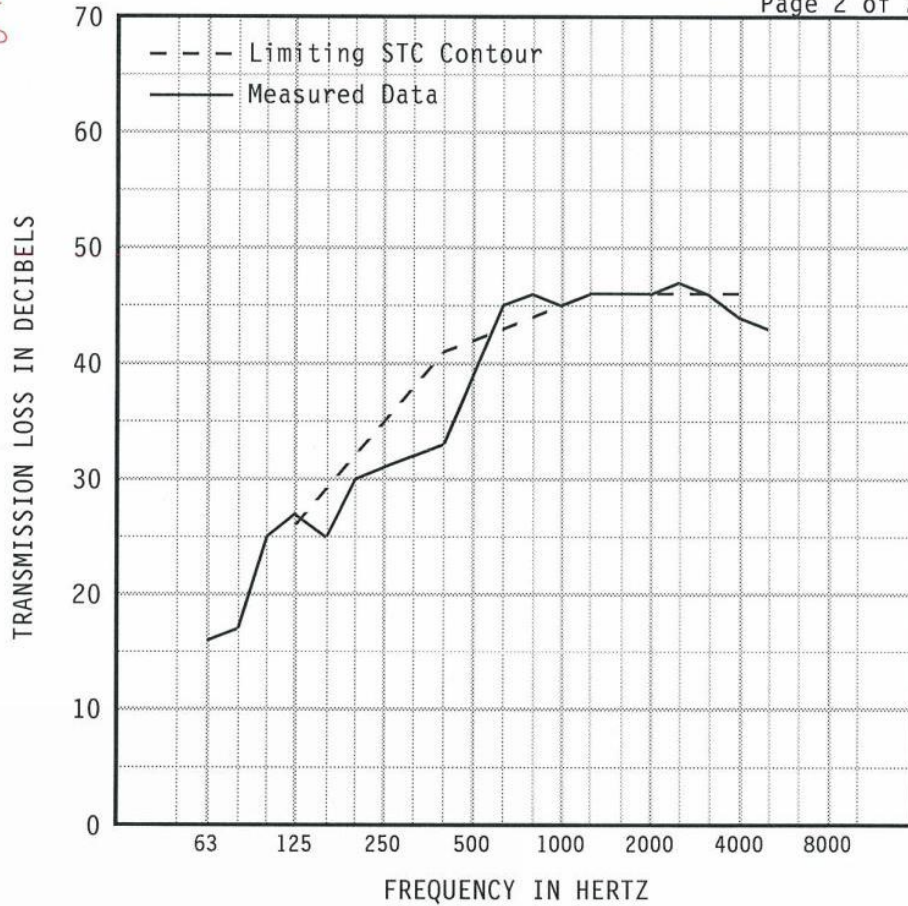

1/3 OCT BND CNTR FREQ	63	80	100	125	160	200	250	315	400	500
TL in dB	*16	17	25	27	25	30	31	32	33	39
95% Confidence in dB deficiencies	1.42	1.92	2.07	1.47	0.89 (4)	0.76 (2)	0.80 (4)	0.52 (6)	0.36 (8)	0.38 (3)
1/3 OCT BND CNTR FREQ	630	800	1000	1250	1600	2000	2500	3150	4000	5000
TL in dB	45	46	45	46	46	46	47	46	44	43
95% Confidence in dB deficiencies	0.29	0.44	0.38 (0)	0.39 (0)	0.36 (0)	0.56 (0)	0.55	0.31 (0)	0.32 (2)	0.50

EWR	OITC	* Minimum estimate of transmission loss. Measurement limited by filler wall. Actual TL will be equal to or greater than value reported.	Specimen Area: 2.92 sq.ft. Temperature: 71.6 deg. F Relative Humidity: 35 % Test Date: 18 March 2014	STC 42 (29)
41	32			

Report must be distributed in its entirety except with written authorization from Western Electro-Acoustic Laboratory

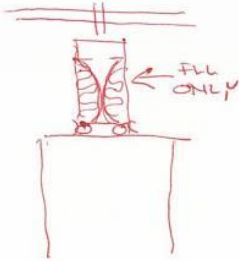

WESTERN ELECTRO-ACOUSTIC LABORATORY

Report No. TL14-168

Page 2 of 2

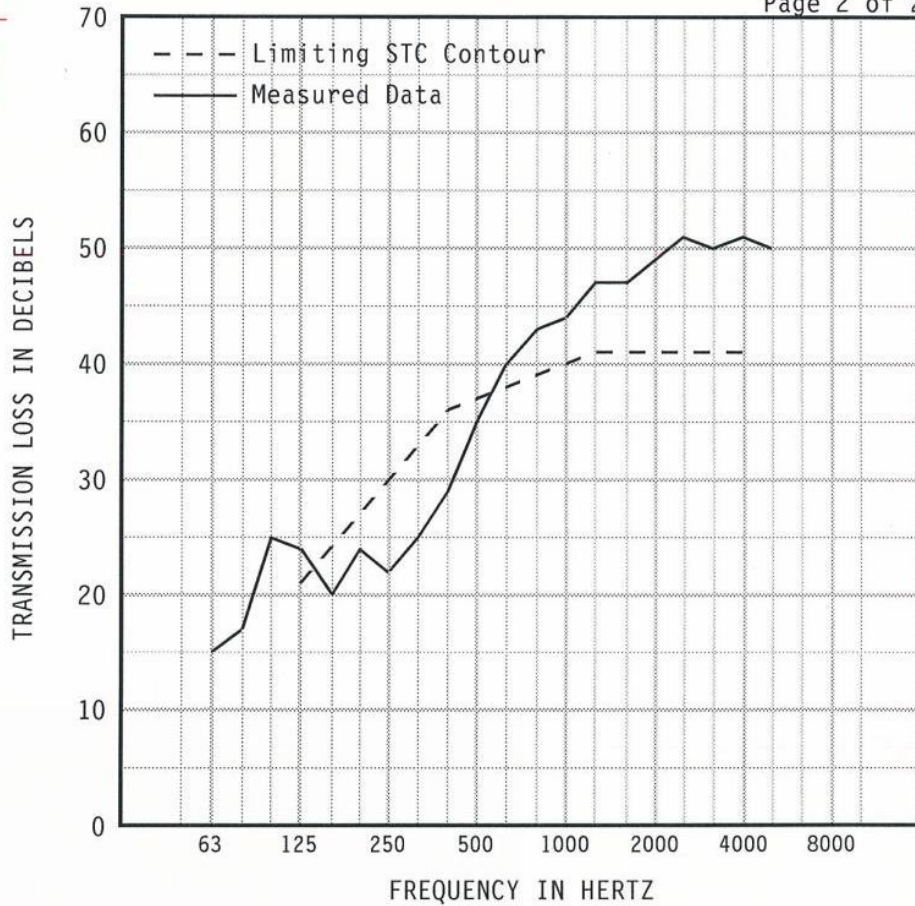

1/3 OCT BND CNTR	FREQ	63	80	100	125	160	200	250	315	400	500
TL in dB		*15	17	25	24	20	24	22	25	29	35
95% Confidence in dB deficiencies		1.42	1.92	2.07	1.47	0.89 (4)	0.76 (3)	0.80 (8)	0.52 (8)	0.36 (7)	0.38 (2)
1/3 OCT BND CNTR	FREQ	630	800	1000	1250	1600	2000	2500	3150	4000	5000
TL in dB		40	43	44	47	47	49	51	50	51	50
95% Confidence in dB deficiencies		0.29	0.44	0.38	0.39	0.36	0.56	0.55	0.31	0.32	0.50

EWR	OITC	* Minimum estimate of transmission loss. Measurement limited by filler wall. Actual TL will be equal to or greater than value reported.	Specimen Area: 2.92 sq.ft. Temperature: 72 deg. F Relative Humidity: 33 % Test Date: 18 March 2014	STC
36	29			37 (32)

Report must be distributed in its entirety except with written authorization from Western Electro-Acoustic Laboratory

WESTERN ELECTRO-ACOUSTIC LABORATORY

Report No. TL14-169

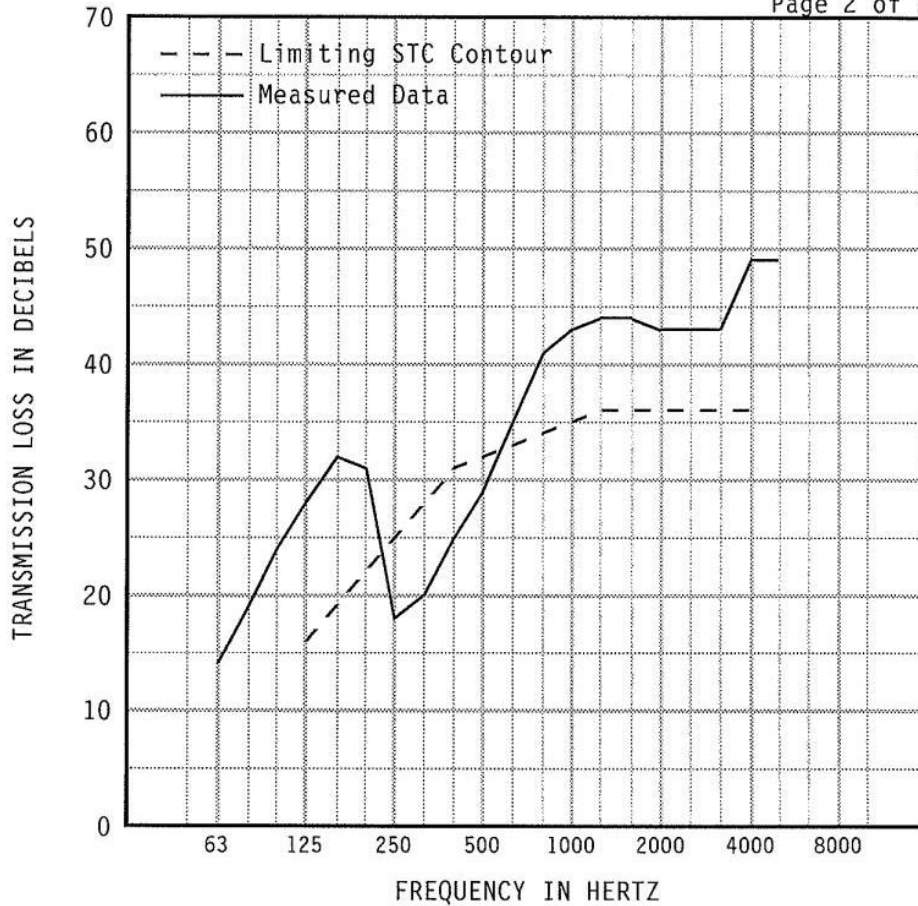

1/3 OCT BND CNTR	FREQ	63	80	100	125	160	200	250	315	400	500
TL in dB		*14	*19	24	*28	32	31	18	20	25	29
95% Confidence in dB deficiencies		1.42	1.92	2.07	1.47	0.89	0.76	0.80 (7)	0.52 (8)	0.36 (6)	0.38 (3)
1/3 OCT BND CNTR	FREQ	630	800	1000	1250	1600	2000	2500	3150	4000	5000
TL in dB		35	41	43	44	44	43	43	43	49	49
95% Confidence in dB deficiencies		0.29	0.44	0.38	0.39	0.36	0.56	0.55	0.31	0.32	0.50
EWR	OITC	* Minimum estimate of transmission loss. Measurement limited by filler wall. Actual TL will be equal to or greater than value reported.									STC
34	27	Specimen Area: 2.92 sq.ft. Temperature: 72 deg. F Relative Humidity: 32 % Test Date: 19 March 2014									32 (24)

Report must be distributed in its entirety except with written authorization from Western Electro-Acoustic Laboratory

WESTERN ELECTRO-ACOUSTIC LABORATORY

Report No. TL14-170

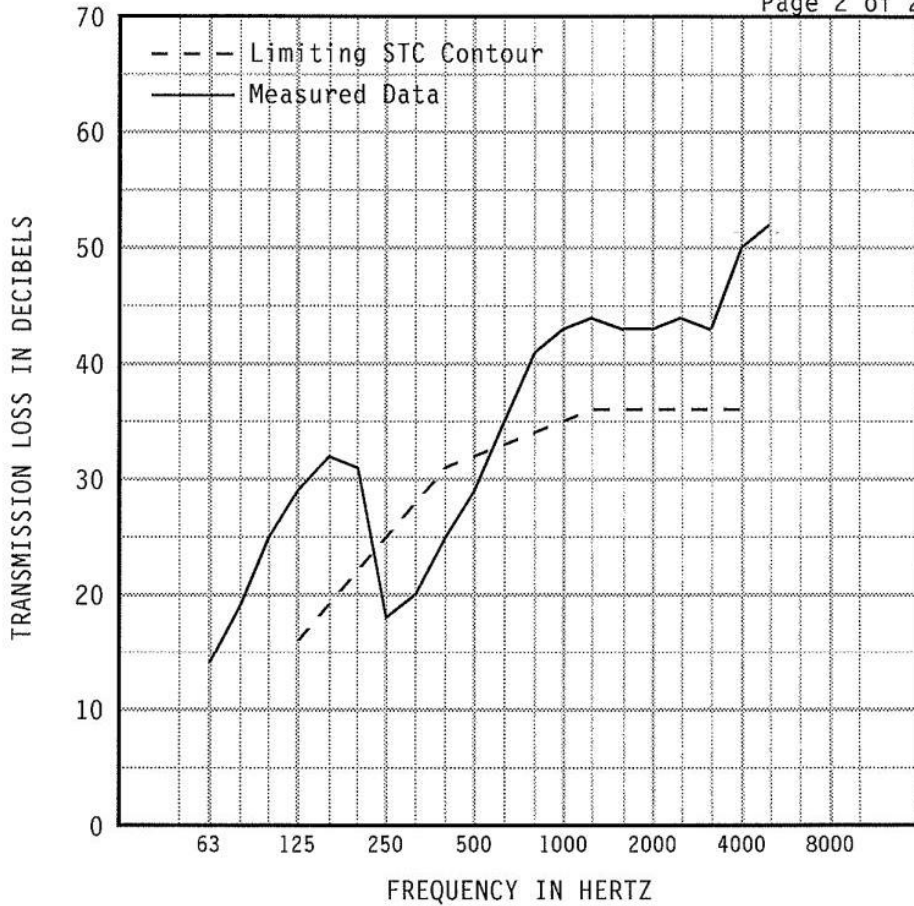

1/3 OCT BND CNTR	FREQ	63	80	100	125	160	200	250	315	400	500
TL in dB		*14	*19	25	*29	32	31	18	20	25	29
95% Confidence in dB deficiencies		1.42	1.92	2.07	1.47	0.89	0.76	0.80 (7)	0.52 (8)	0.36 (6)	0.38 (3)
1/3 OCT BND CNTR	FREQ	630	800	1000	1250	1600	2000	2500	3150	4000	5000
TL in dB		35	41	43	44	43	43	44	43	50	52
95% Confidence in dB deficiencies		0.29	0.44	0.38	0.39	0.36	0.56	0.55	0.31	0.32	0.50

EWR	OITC	* Minimum estimate of transmission loss. Measurement limited by filler wall. Actual TL will be equal to or greater than value reported.	Specimen Area: 2.92 sq.ft.	STC
34	27		Temperature: 71.8 deg. F	32
			Relative Humidity: 36 %	(24)
			Test Date: 19 March 2014	

Report must be distributed in its entirety except with written authorization from Western Electro-Acoustic Laboratory

WESTERN ELECTRO-ACOUSTIC LABORATORY

Report No. TL14-171

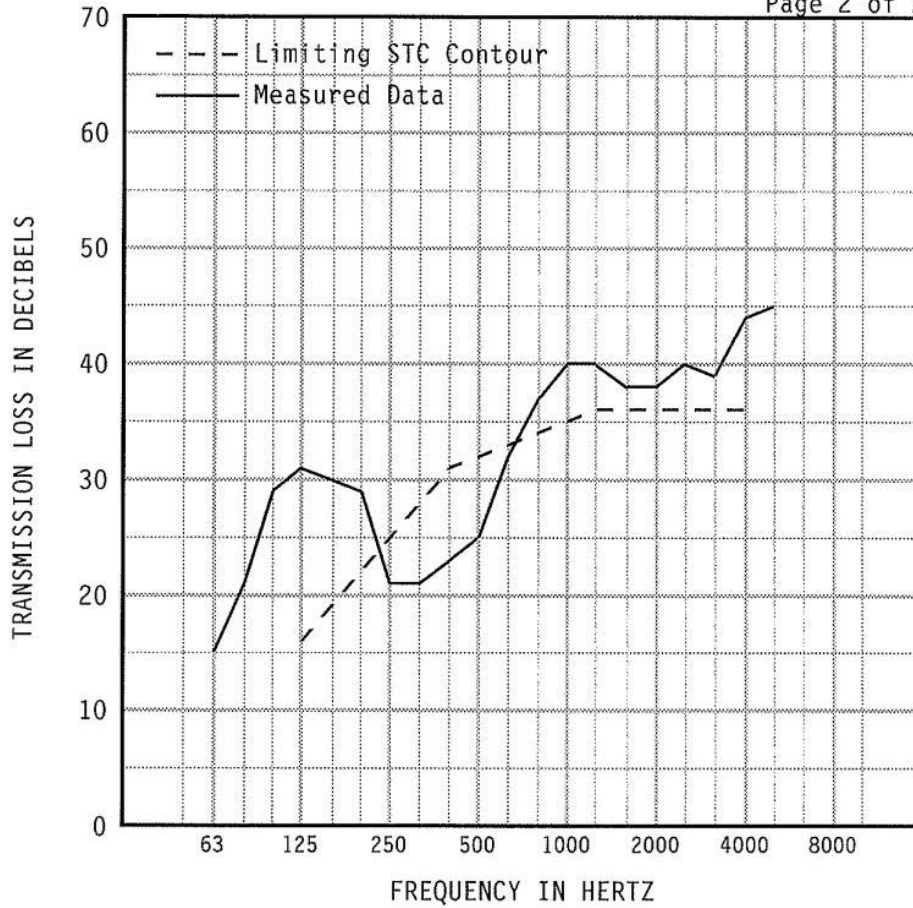

1/3 OCT BND CNTR	FREQ	63	80	100	125	160	200	250	315	400	500
TL in dB		*15	*21	*29	*31	30	29	21	21	23	25
95% Confidence in dB deficiencies		1.42	1.92	2.07	1.47	0.89	0.76	0.80 (4)	0.52 (7)	0.36 (8)	0.38 (7)
1/3 OCT BND CNTR	FREQ	630	800	1000	1250	1600	2000	2500	3150	4000	5000
TL in dB		32	37	40	40	38	38	40	39	44	45
95% Confidence in dB deficiencies		0.29 (1)	0.44	0.38	0.39	0.36	0.56	0.55	0.31	0.32	0.50
EWR	OITC	* Minimum estimate of transmission loss. Measurement limited by filler wall. Actual TL will be equal to or greater than value reported.									STC
33	28	Specimen Area: 2.92 sq.ft. Temperature: 72.3 deg. F Relative Humidity: 31 % Test Date: 19 March 2014									32 (27)

Report must be distributed in its entirety except with written authorization from Western Electro-Acoustic Laboratory

APPENDIX C ANCILLARY SOUND ANALYSIS

C.1 INTRODUCTION

Additional transmission loss comparison overlays between tests phases are provided for archival purposes.

C.2 PHASE 1 MULLION CONTROLS

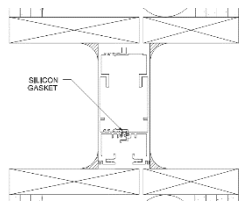
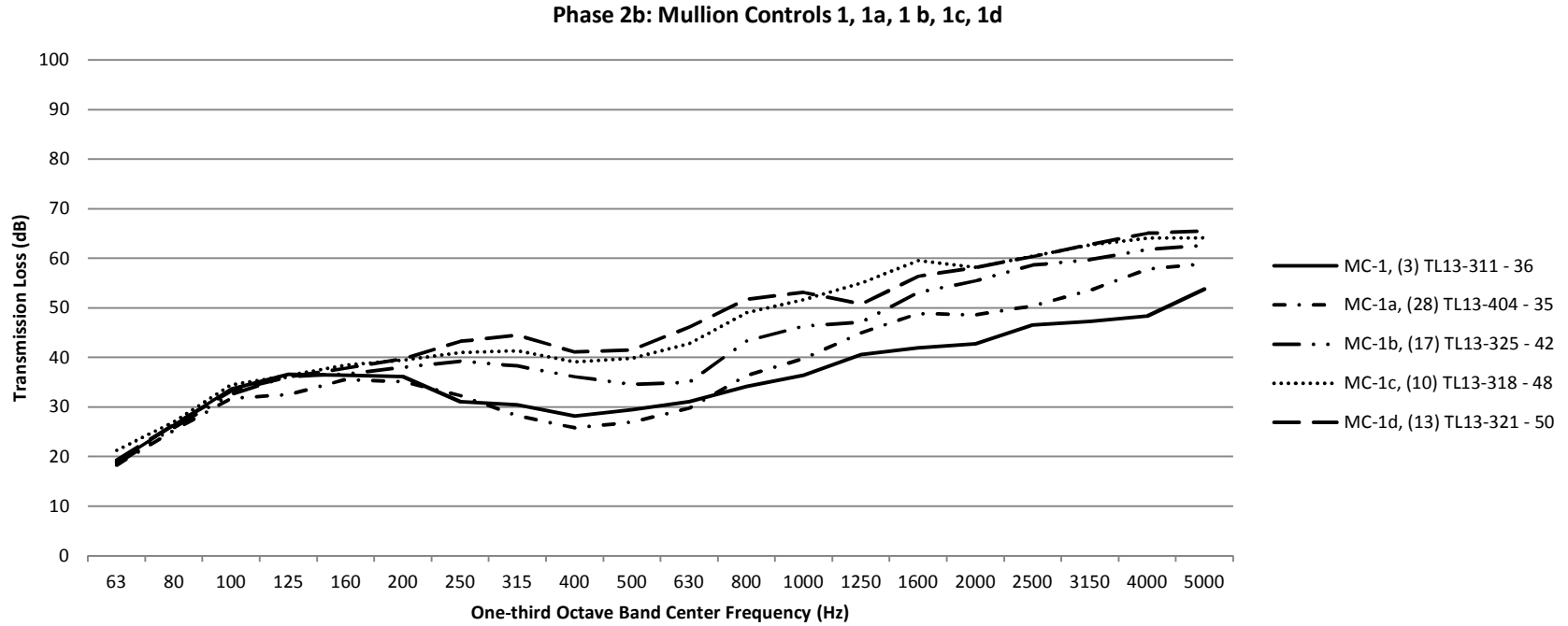

MC-1, (3) TL13-311 - 36

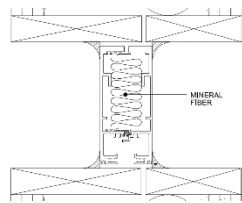

MC-1a, (28) TL13-404 - 35

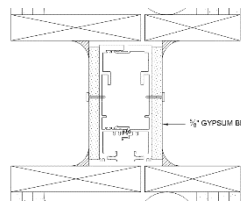

MC-1b, (17) TL13-325 - 42

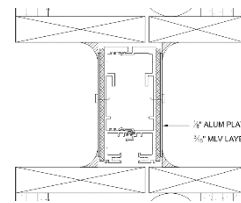

MC-1c, (10) TL13-318 - 48

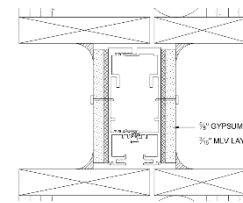

MC-1d, (13) TL13-321 - 50

FIGURE C- 1: PHASE 1-A TRANSMISSION LOSS CURVES

C.3 UVM TEST ELEMENT COMPARISON WITH A 4" AIRSPACE

Phase 2b: Plate Configurations - 4" airspace with mullion
(1/8" aluminum plate)

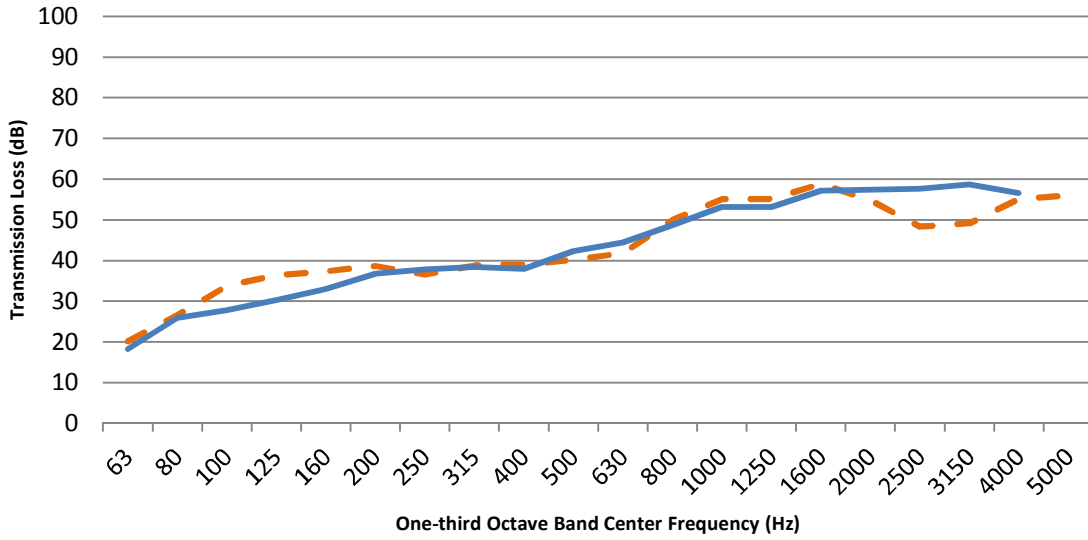

— * (4) TL13-312, STC 47 — (51) TL13-610 - 47

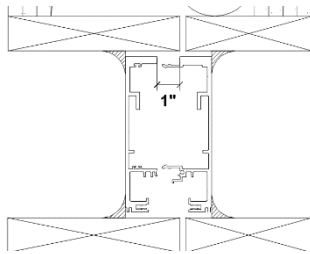

(4) TL13-312

Phase 1 – impractical mullion separated to create a 4" airspace

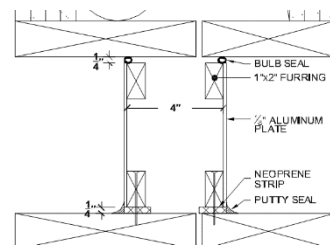

TL13-610

Phase 2b – parallel plates of aluminum without an interconnection

FIGURE C-2: 4" AIRSPACE COMPARISON, MULLION AND PLATE CONNECTION

C.4 UVM TEST ELEMENT COMPARISON WITH A 3" AIRSPACE

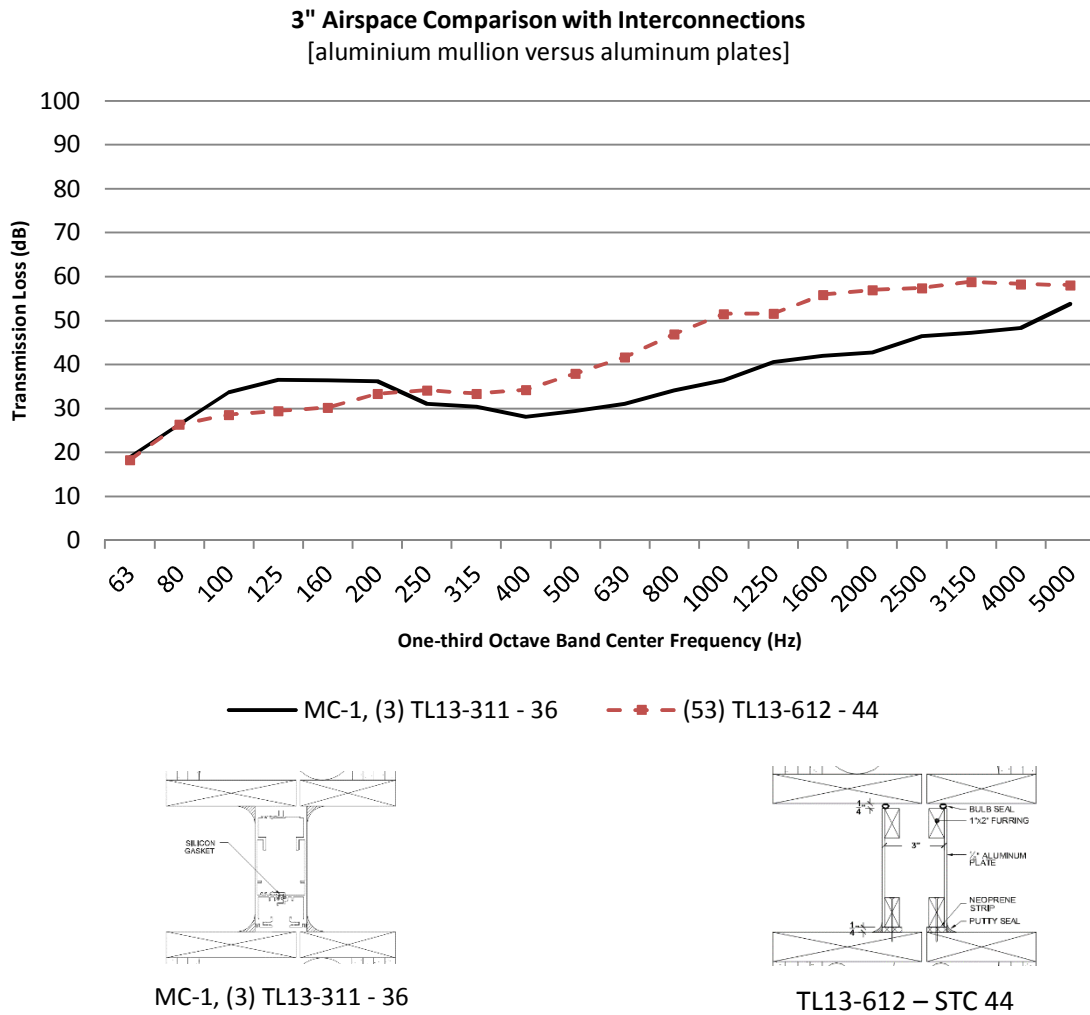

FIGURE C-3 3" AIRSPACE COMPARISON, MULLION AND PLATE CONNECTION

C.5 UVM TEST ELEMENT COMPARISON WITH A 3" AIRSPACE, BATT INFILL

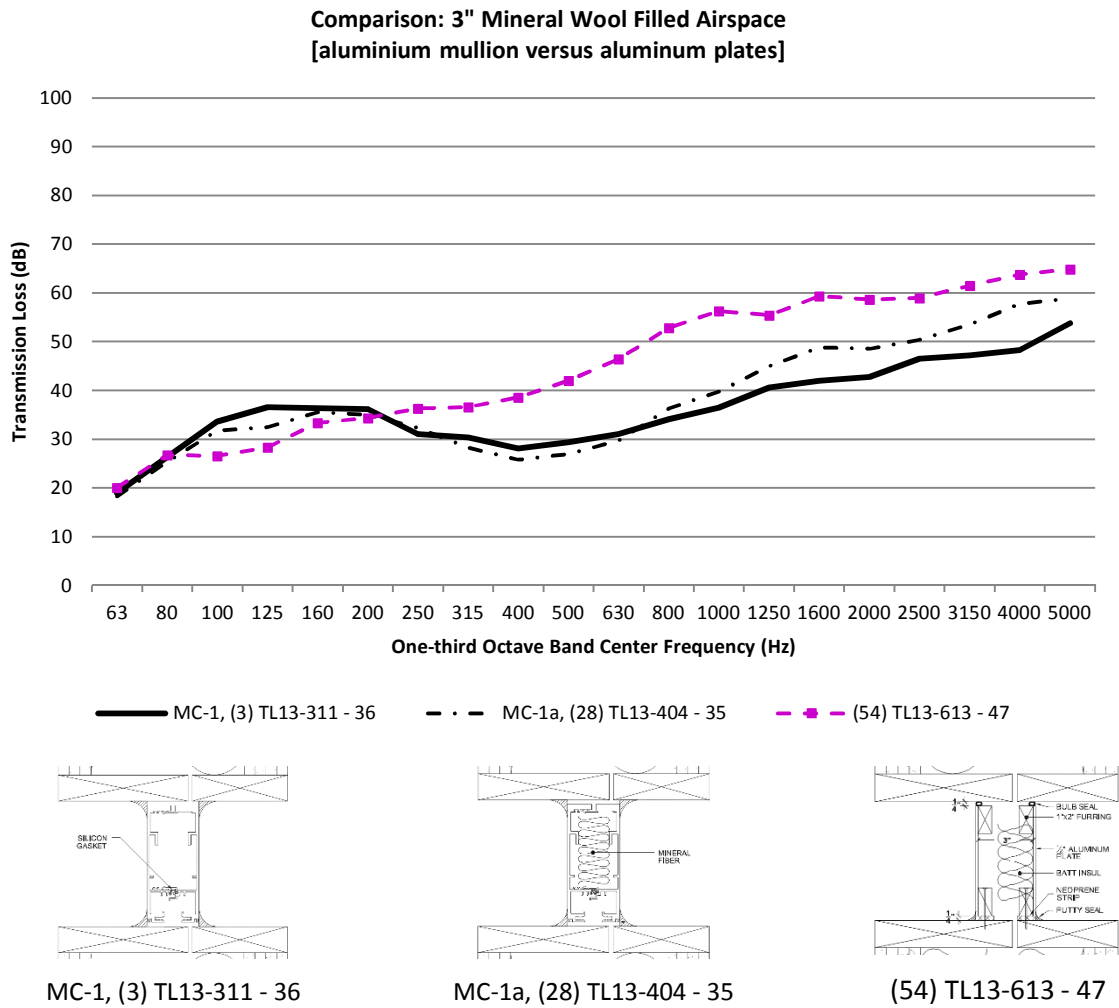

FIGURE C-4: 3" AIRSPACE AND BATT INFILL COMPARISON, MULLION AND PLATE CONNECTION

C.6 UVM TEST ELEMENT COMPARISON WITH A 3" AIRSPACE, GYPSUM OVERCLAD

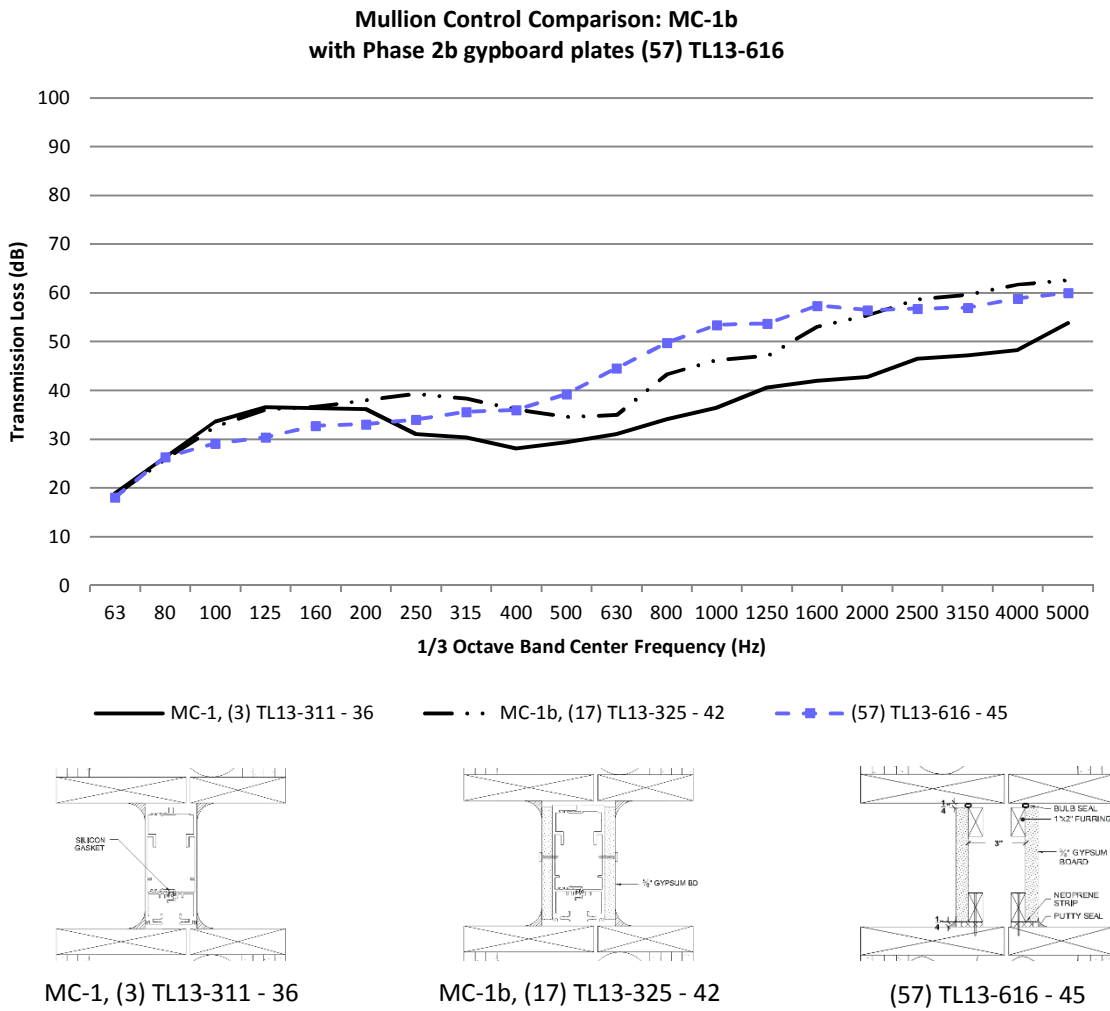

FIGURE C-5: 3" AIRSPACE AND GYPSUM OVERCLAD, MULLION AND PLATE CONNECTION

C.7 PHASE 2B CLASS A SUMMARY GRAPHS

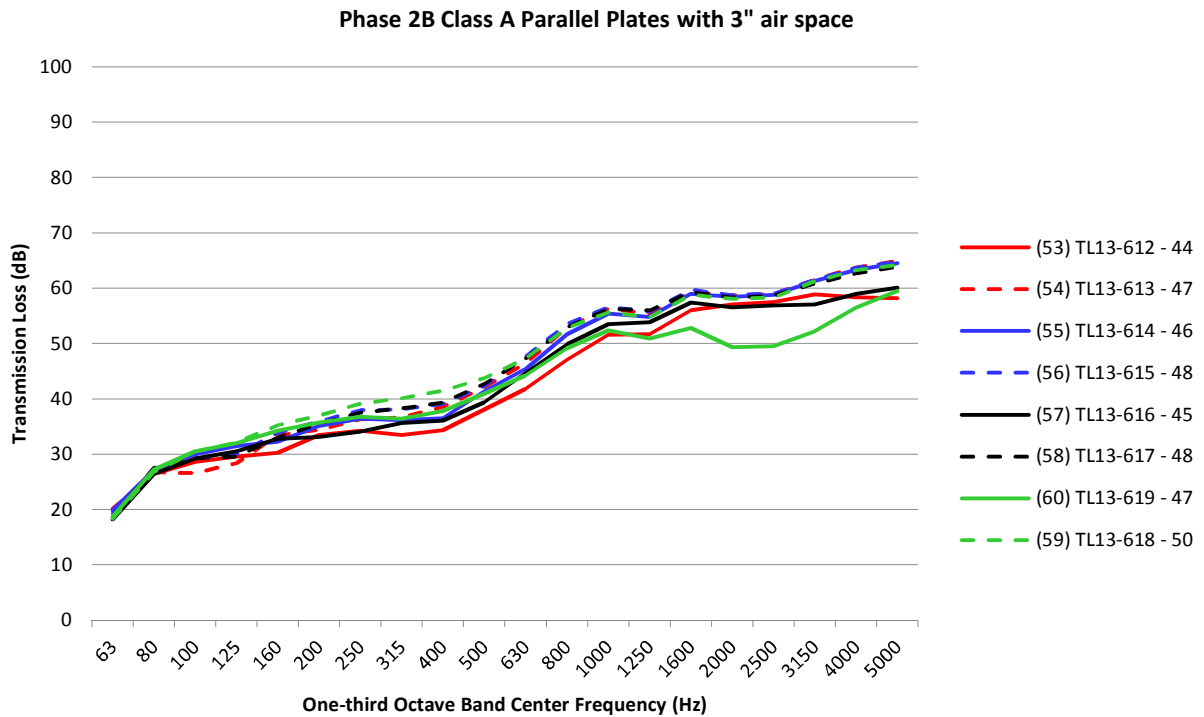

FIGURE C- 6: PHASE 2B PARALLEL PLATE TESTS WITH 3" AIR CAVITIES

Test Number	Plate Assembly
(53) TL13-612 - 44/37	1/8" aluminum
(54) TL13-613 - 47/38	1/8" aluminum + batt
(55) TL13-614 - 46/39	1/8" aluminum + MLV
(56) TL13-615 - 48/39	1/8" aluminum + MLV + batt
(57) TL13-616 - 45/38	5/8" gypsum board plates
(58) TL13-617 - 48/39	5/8" gypsum board plates + batt
(60) TL13-619 - 47/39	5/8" gypsum board + MLV + Alum. Plate
(59) TL13-618 - 50/41	5/8" gypsum board + MLV + Alum. Plate+ batt

C.8 PHASE 2B PARALLEL PLATE WITH VARIED AIR SPACE

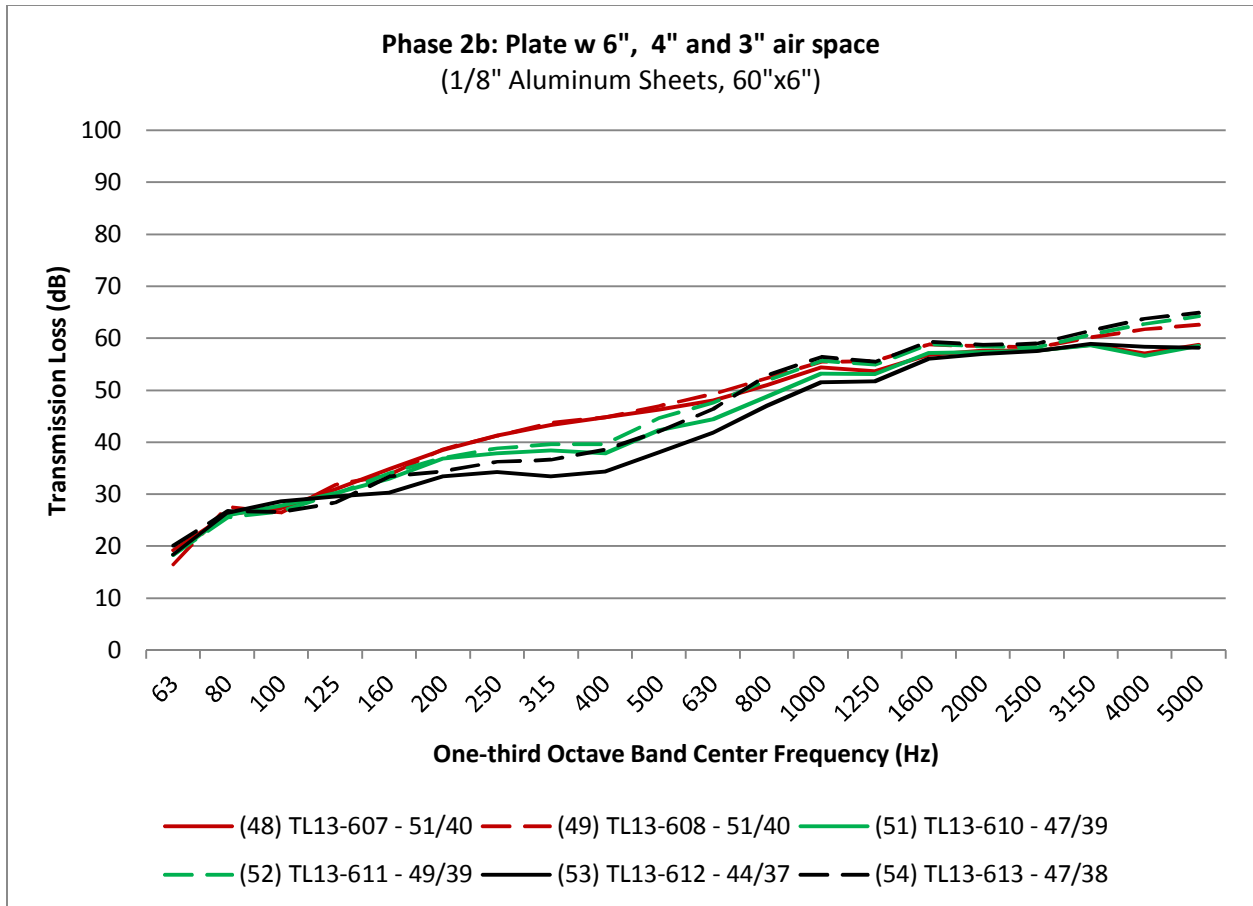

FIGURE C- 7: SOUND TRANSMISSION LOSS OF ALUMINUM PLATES ONLY WITH 3", 4" OR 6" AIR CAVITY

Test Number	Description of Air Space between Aluminum Plates
(48) TL13-607 - 51/40	6" air cavity
(49) TL13-608 - 51/40	6" air cavity + batt
(51) TL13-610 - 47/39	4" air cavity
(52) TL13-611 - 49/39	4" air cavity + batt
(53) TL13-612 - 44/37	3" air cavity
(54) TL13-613 - 47/38	3" air cavity + batt

C.9 COMPARISONS BETWEEN PHASE 1 AND PHASE 3

Comparisons between Phase 1 mullions, TL13-311 (MC-1) and TL13-323 (MC-2), are compared with Phase 3 testing.

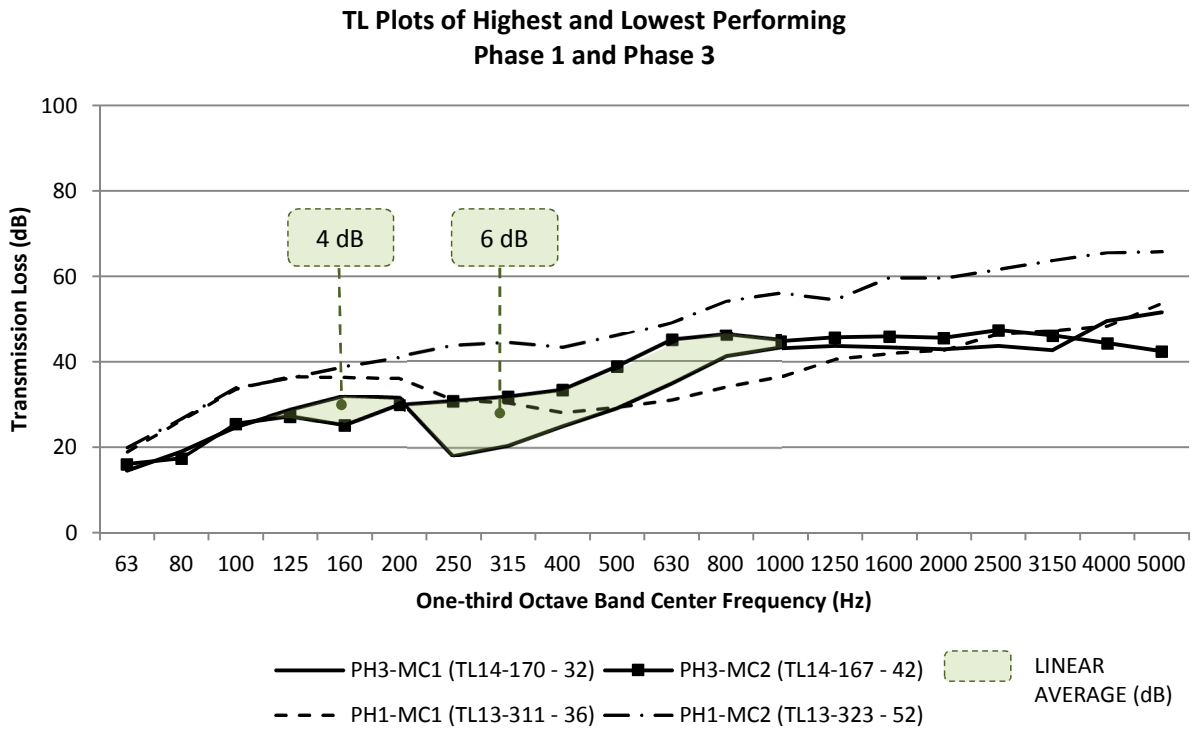

FIGURE C- 8: TL SPECTRA OF PH3-MC1 WITH PH1-MC1 AND PH3-MC2 WITH PH1-MC2

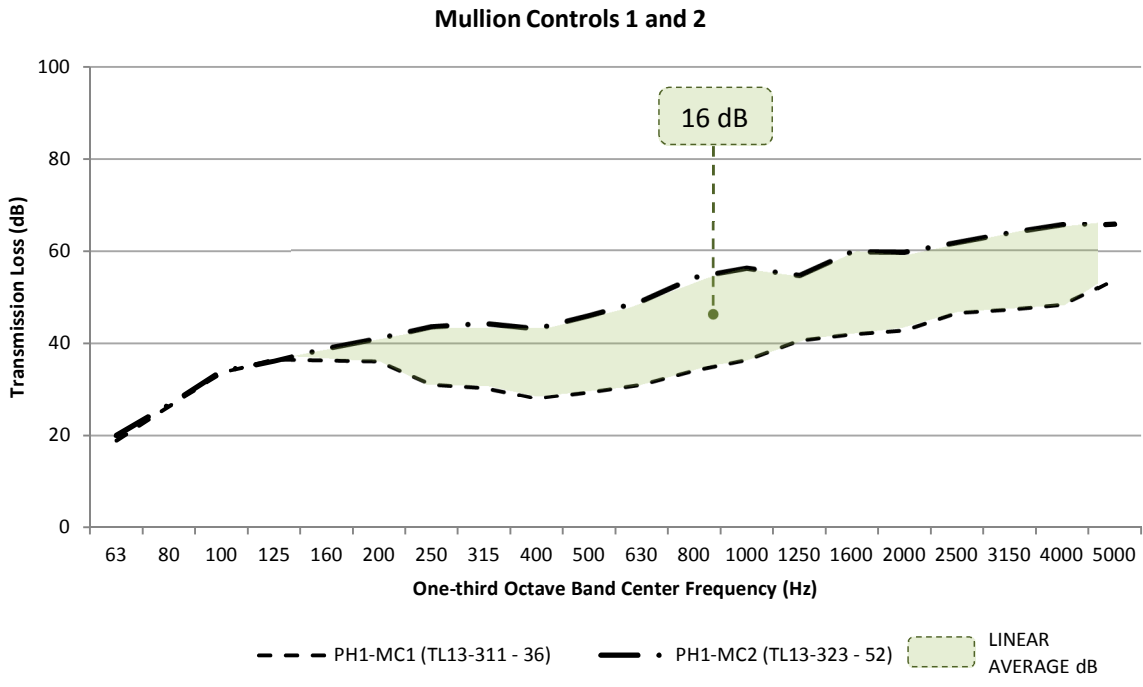

FIGURE C- 9: TRANSMISSION LOSS COMPARISON BETWEEN CONTROL MULLIONS MC1 AND MC2

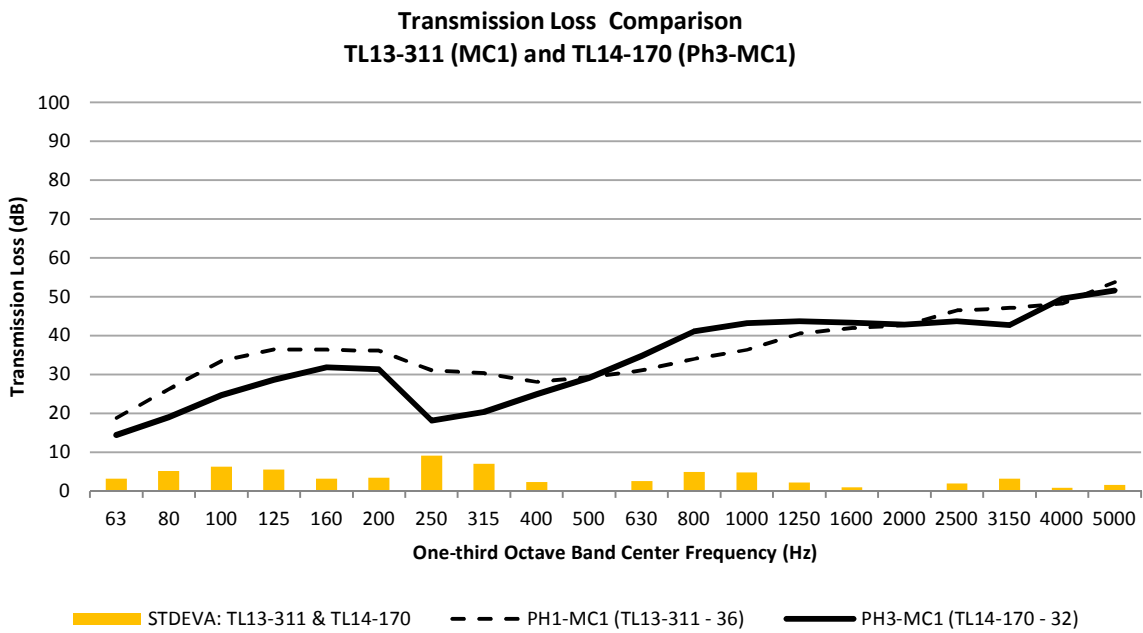

FIGURE C- 10: PHASE 1-MC1 (TL13-311) AND PHASE 3-MC1 (TL14-170)

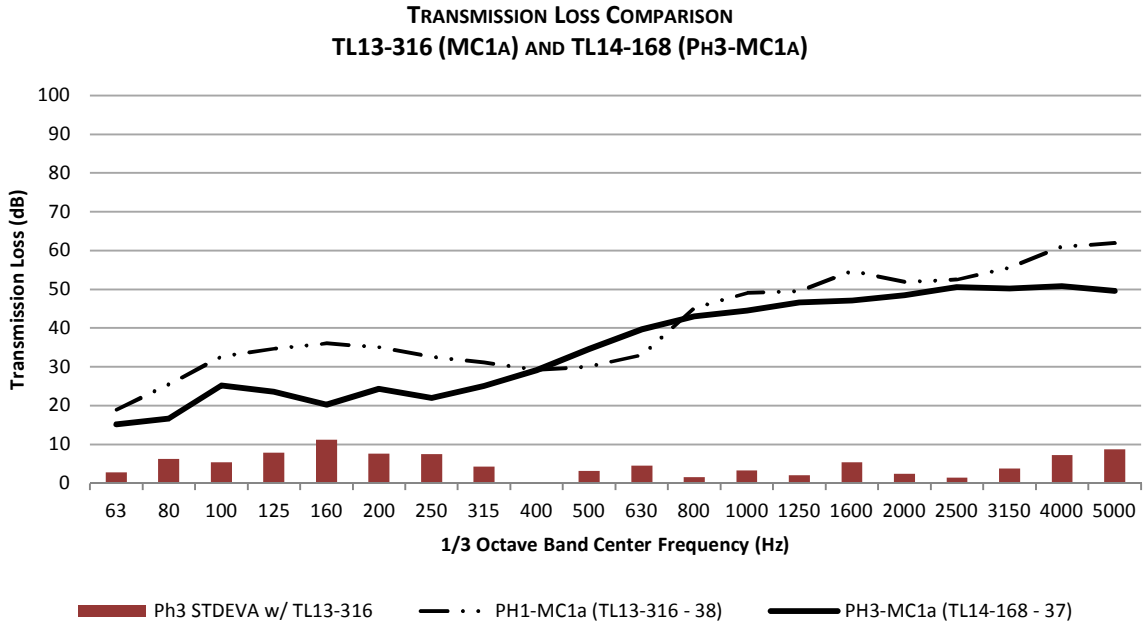

FIGURE C- 11: PHASE 1-M1A (TL13-316) AND PHASE 3-MC1A (TL14-168)

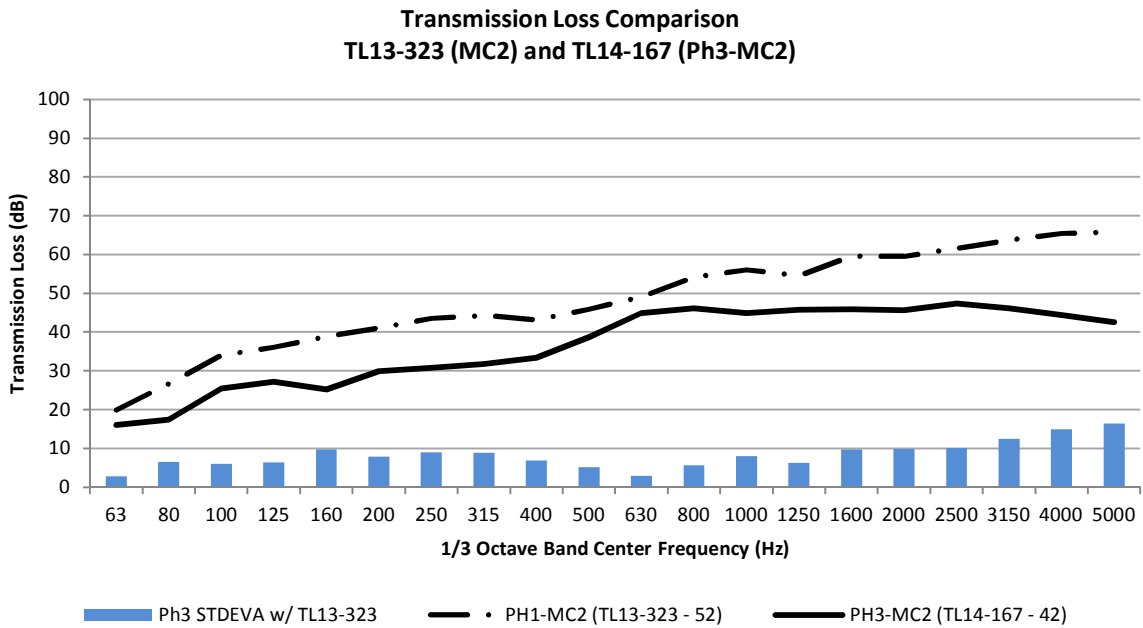
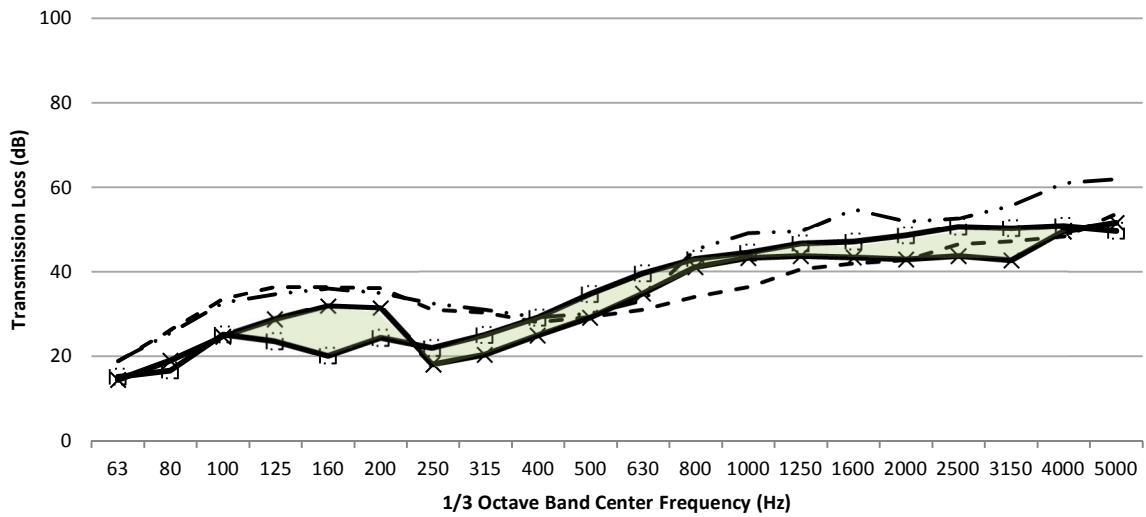

FIGURE C- 12: PHASE 1-MC2 (TL13-323) AND PHASE 3-MC2 (TL14-167)

C.10 UNCONNECTED AND CONNECTED (HOLLOW AND FILLED)

COMPARISON 1 AND COMPARISON 1A



- - - PH1-MC1 (TL13-311 - 36) — x — PH3-MC1 (TL14-170 - 32)
 - . . PH1-MC1a (TL13-316 - 38) — □ — PH3-MC1a (TL14-168 - 37)

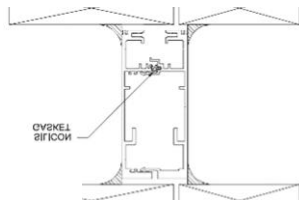

PHASE 1-MC1 (TL13-311)

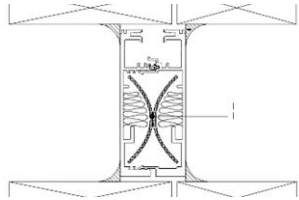

PHASE 1-MC1A (TL13-316)

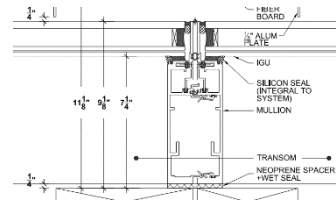

PHASE 3-MC1 (TL14-170)

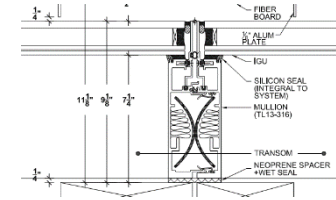

PHASE 3-MC1A (TL14-168)

FIGURE C- 13: TL PLOTS OF PHASE 1 (MC1/1A) AND PHASE 3 (MC1/1A)

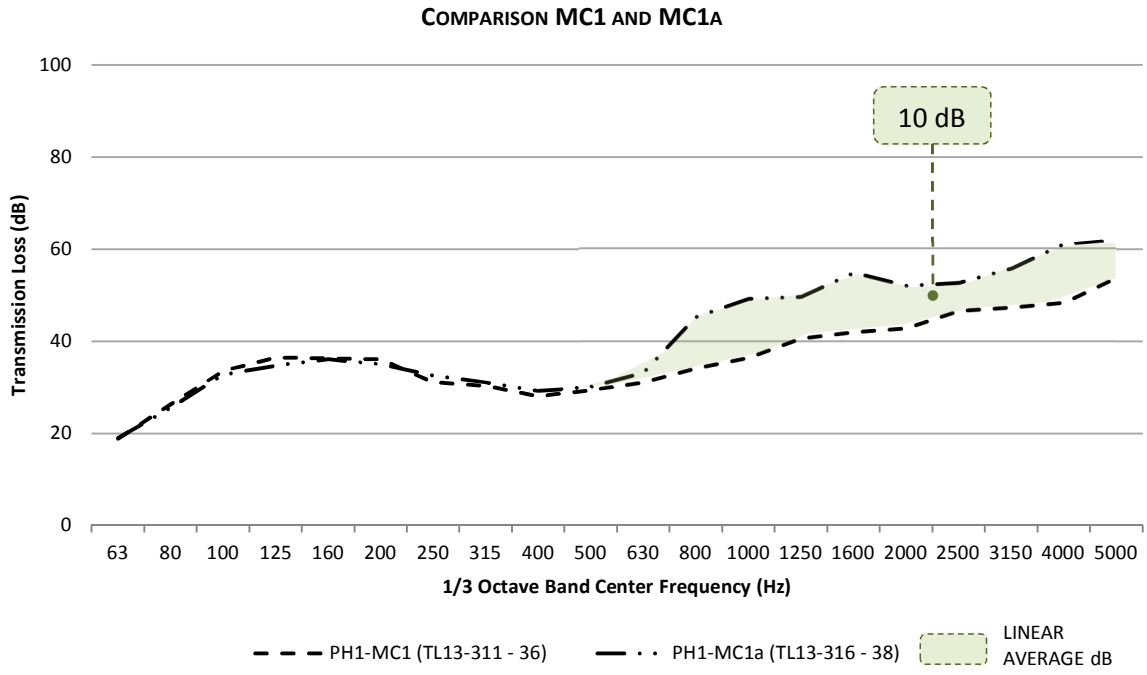

FIGURE C- 14: TL PLOTS OF COMPARISON MC1 AND MC1A

APPENDIX D ANCILLARY VIBRATION ANALYSIS

D.1 INTRODUCTION

Vibration measurements were conducted on the curtain wall assembly during Phase 3 to compare the acoustic energy passing laterally from the source to receiving chamber at the glass, vertical mullion and horizontal mullion. Description of the multi-chamber test setup including semi-anechoic enclosures is described in Chapter 3.

Typical accelerometer measurement locations on the curtain wall at the source chamber was mirrored at the receiving chamber so that measurements may be conducted simultaneously (Figure D-1).

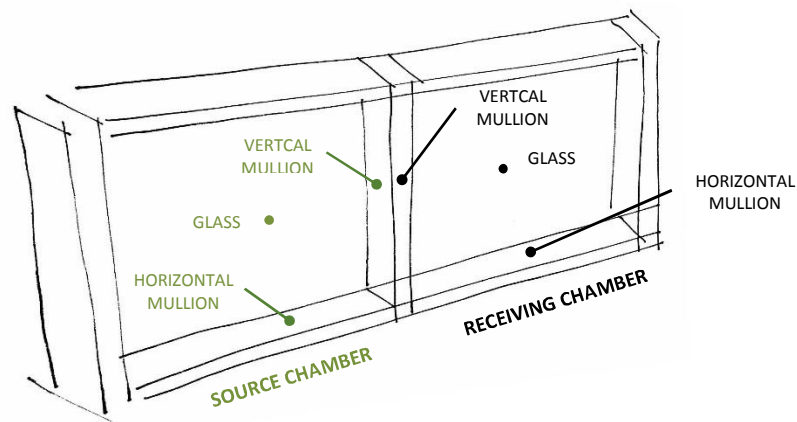

FIGURE D- 1: TYPICAL LOCATION OF THE ACCELEROMETERS AT THE SOURCE AND RECEIVING CHAMBERS

The vibration measurements are intended to provide a basis to compare

- the acoustic energy loss from source to receiving side at mirrored accelerometer locations and
- vibration levels between the vertical mullion, horizontal mullion, and glass at the receiving chamber.

The preliminary vibration measurement results and analysis is subject to future work. The initial investigation discussed in Appendix D is provided for archival purposes.

D.2 VIBRATION MEASUREMENT SET UP

Four sets of vibration measurements were taken based on several configurations (Table D – 1).

Configuration Number	UVM Assembly Used (from Phase 3)	Chamber 3S (Semi-anechoic enclosure)	Chamber 3R (Semi-anechoic enclosure)
EV1 [A _v]	TL14-167 (STC 42)	Fully Enclosed	Fully Enclosed
EV2 [B _v]	TL14-170 (STC 32)	Fully Enclosed	Fully Enclosed
EV3a [C _v]	TL14-171 (STC 32)	Fully Enclosed	Removed
EV3b [D _v]	TL14-170 (STC 32)	Removed	Removed

TABLE D- 1: PHASE 3 CONFIGURATION OF VIBRATION MEASUREMENT

- [A_v] vibration measurement**
 The EV1 [A_v] vibration measurement was conducted on the TL14-167 test specimen; the center vertical mullion is overlaid and filled.
 The 3S and 3R chambers were fully enclosed.
- [B_v] vibration measurement**
 The EV2 [B_v] vibration measurement was conducted on the TL14-170 test specimen; the center vertical mullion is exposed and hollow.
 The 3S and 3R chambers were fully enclosed.
- [C_v] vibration measurement**
 Vibration measurement was conducted on the TL14-171 test rig.
 The 3R chamber was removed.
- [D_v] vibration measurement**
 Vibration test EV3b does not have a corresponding laboratory test.
 Both the 3S and 3R chambers were removed.

The semi-anechoic chamber enclosures at configurations [C_v] and [D_v] were removed during the measurement as indicated (Table D-1). This changes the structural stiffness of the system and may influence the results.

D.2.1 Measurement and Chamber Set Up

The Phase 3 UVM Test chamber set up described in Chapter 3 was used to locate the accelerometers at typical locations indicated on the curtain wall specimen (Figure D-2).

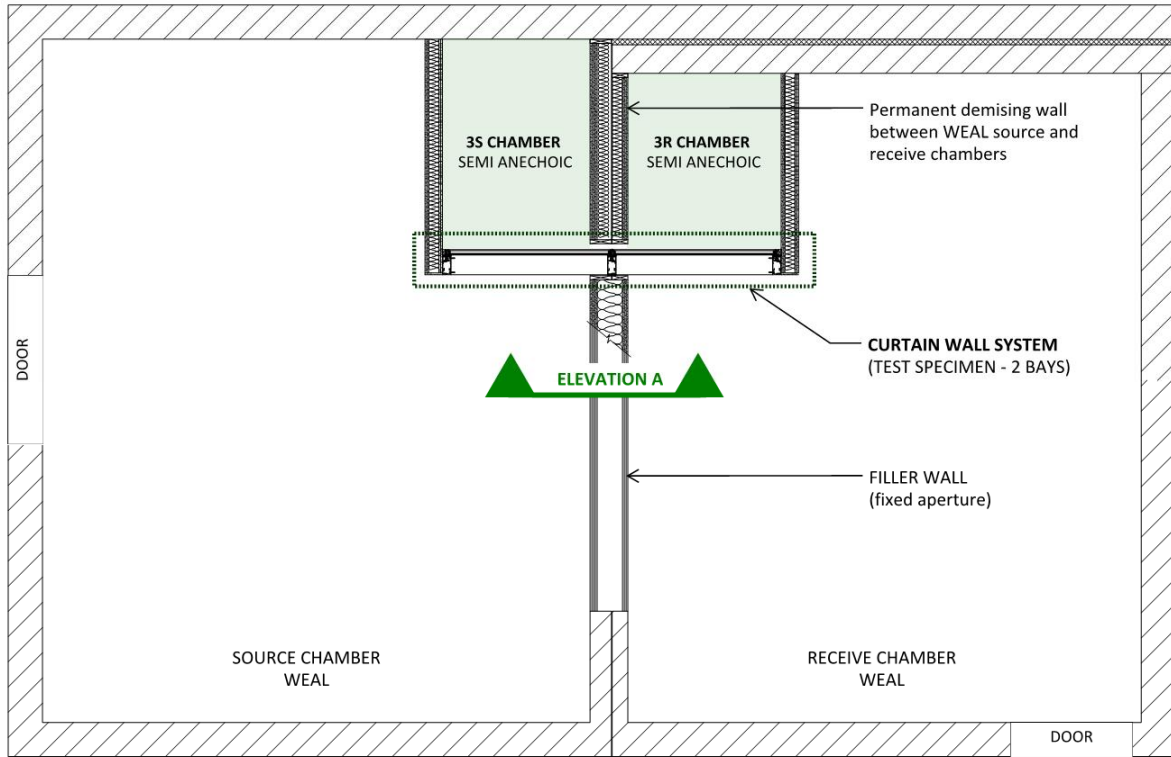

FIGURE D- 2: Plan drawing of weal test chambers and phase 3 test rig 3s/3r chambers

An elevation of the curtain wall bay specimen is shown with the accelerometer measurement locations at the 3S and 3R chambers (Figure D-3).

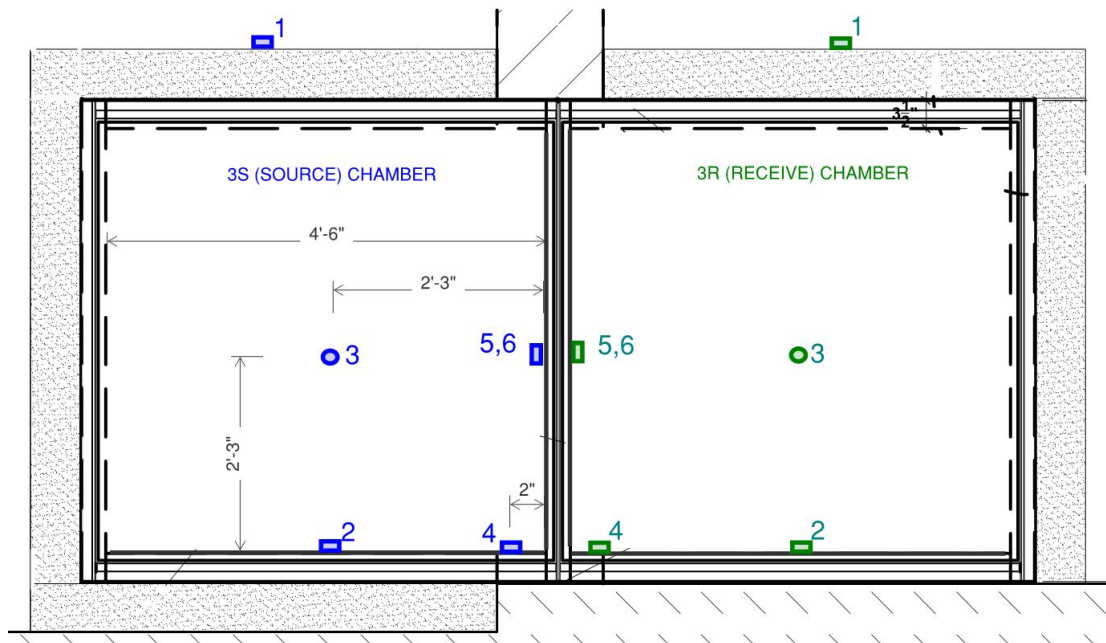

FIGURE D- 3: Elevation A: View of Accelerometer locations on chambers 3S and 3R for EV2

The accelerometers numbered in Figure D-3 correspond to the axis and location description for the EV2 [B_v] (Table D – 2).

Source	Receiver	Axis	Surface Material	Location
1	1	X	gypsum	mid-span on gypsum board header
2	2	X	aluminum	mid-span on lower transom
3	3	Z	glass	mid-span center on glass bay
4	4	X	aluminum	on lower transom 2" from vertical mullion
5	5	Y	aluminum	on vertical mullion 2'-3" mid-span
6	6	Y	aluminum	on vertical mullion 2'-3" mid-span

TABLE D- 2: PHASE 3 CONFIGURATION OF VIBRATION MEASUREMENT

D.2.2 Equipment and Procedure

Several pieces of equipment were used for the measurements (Table D – 3).

Device	Manufacturer	Model	Serial Number	Comments
Accelerometer	Endevco	7703A-1000	10125	Source
Accelerometer	Endevco	7706-1000	AD71, 977.0 pC/g	Receiver
Sound Level Meter Input	Brüel & Kjær	2260	(VA Meter #7)	Source
Sound Level Meter Input	Brüel & Kjær	2260	(VA Meter #4)	Receiver
Computer Software Analyzer	Brüel & Kjær	Evaluator Type 7820 Version 4.16.4	--	--

TABLE D- 3: VIBRATION MEASUREMENT EQUIPMENT

The settings on the Brüel & Kjær 2260 meter were

- Range: 10dB - 100dB
- One-third octave: Low Frequency
- Statistical Measurements: FAST
- measurements flat spectrum, L&L

The Brüel & Kjær Evaluator Type 7820 Version 4.16.5 software was used to analyze the data.

The two B&K 2260 meters were time synced to take simultaneous measurements.

The acoustic source of energy was from the loudspeaker in the source laboratory chambers which emitted 120 dB of pink noise.

D.3 VIBRATION MEASUREMENT RESULTS

Acceleration level (dB) L_{EQ} measurements were taken over a period of 10 second (Figure D – 4).

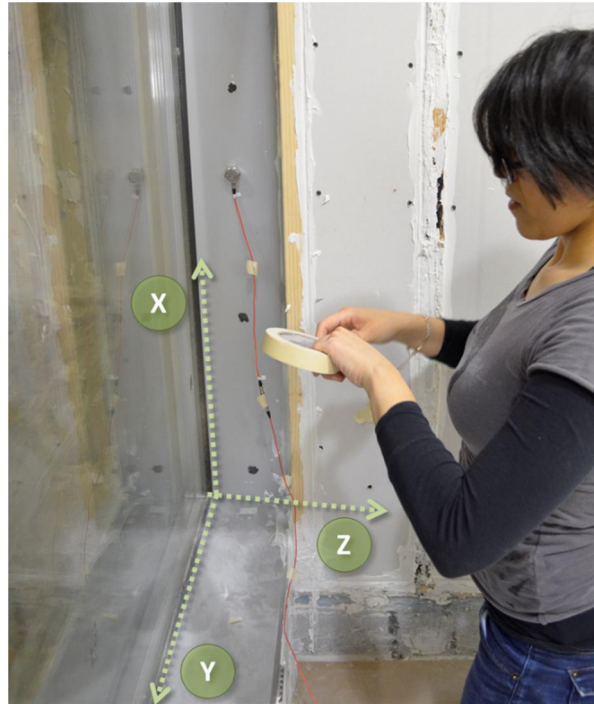

FIGURE D- 4: Axis designation for vibration measurements

Each measurement was 10 seconds. A 5 second dB L_{EQ} time period was used for analysis to omit ramp up and down from the loudspeaker.

•

D.3.1 [A_v] Vibration Measurement Results

The 5 sec dB L_{Leq} at the source and receiving chambers for the [A_v] test rig are summarized (Table D-4).

Test	L _{Leq} 5 sec, dB	Axis	[Surface Material] Accelerometer Location
[A _v] S1	83	X	[gyp board] mid-span on gypsum board header
[A _v] R1	80		
[A _v] S2	100	X	[aluminum] mid-bay horizontal on bottom horizontal mullion
[A _v] R2	96		
[A _v] S3	102	Z	[glass] mid-bay horizontal, 12" above bottom horizontal mullion
[A _v] R3	89		
[A _v] S4	--	Z	[glass] same as S3/R3, (ambient)
[A _v] R4,5	--		
[A _v] S5	103	X	[aluminum] at bottom transom, 2" from center vertical mullion
[A _v] R6	98		
[A _v] S6	100	Z	[glass] 12" above bottom transom 2" from center vertical mullion
[A _v] R7	89		
[A _v] S7	100	Y	[gypsum+mlv] on mullion 12" above bottom horizontal mullion
[A _v] R8	93		
[A _v] S8	101	Y	[gypsum+mlv] repeat - taped accelerometer from detaching
[A _v] R9	94		

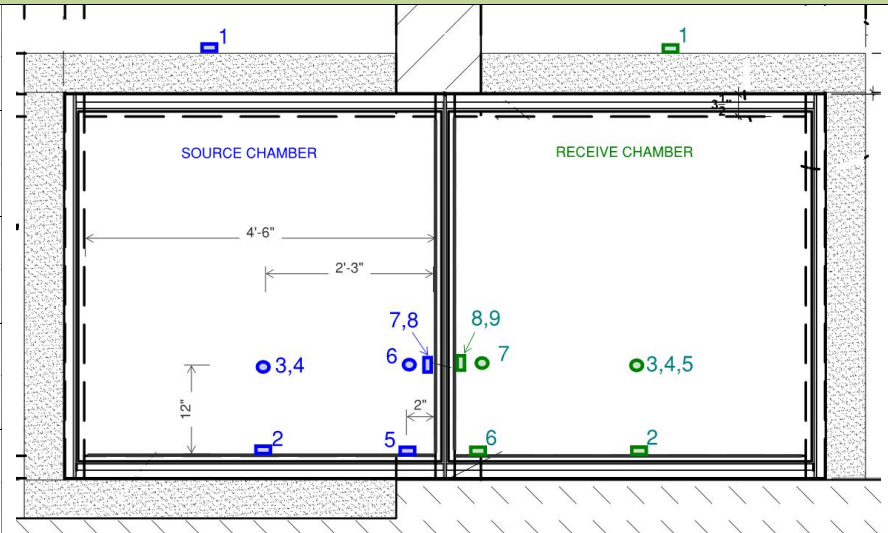

TABLE D- 4: [A_v] SOURCE AND RECEIVER RESULTS, 5 SEC DB L_{Leq}

D.3.2 [B_v] Vibration Measurement Results

The 5 sec dB L_r,L_{eq} at the source and receiving chambers for the [B_v] test rig are summarized (Table D-5).

Test	L _r ,L _{eq} 5 sec, dB	Axis	[Surface Material] Accelerometer Location
[B _v] S1	92	X	[gyp board] mid-span on gypsum board header
[B _v] R1	81		
[B _v] S2	94	X	[aluminum] mid-span on lower horizontal mullion
[B _v] R2	92		
[B _v] S3	93	Z	[glass] mid-span center on glass bay
[B _v] R3	88		
[B _v] S4	94	X	[aluminum] on lower horizontal mullion 2" from vertical mullion
[B _v] R4	93		
[B _v] S5	93	Y	[aluminum] on vertical mullion 2'-3" mid-span
[B _v] R5	93		
[B _v] S6	--	Y	[aluminum] on vertical mullion 2'-3" mid-span (ambient)
[B _v] R6	39		

TABLE D- 5: [B_v] SOURCE AND RECEIVER RESULTS, 5 SEC DB L_r,L_{EQ}

D.3.3 [C_v] Vibration Measurement Results

The 5 sec dB L_{Leq} at the source and receiving chambers for the [C_v] test rig are summarized (Table D-6).

Test	L _{Leq} 5 sec, dB	Axis	[Surface Material] Accelerometer Location
[C _v] S1	101	Z	[glass] 6" above horizontal mullion, 2" from vert mullion
[C _v] R1	86		
[C _v] S2	102	Z	[glass] 2'-3" above horizontal mullion, 2" from vertical mullion
[C _v] R2	87		
[C _v] S3	102	Z	[glass] 6" above horizontal mullion, 2'-3" from vertical mullion mid-span center on glass bay
[C _v] R3	87		
[C _v] S4	102	Z	[glass] 2'-3" above horizontal mullion, 2'-3" from vertical mullion
[C _v] R4	85		

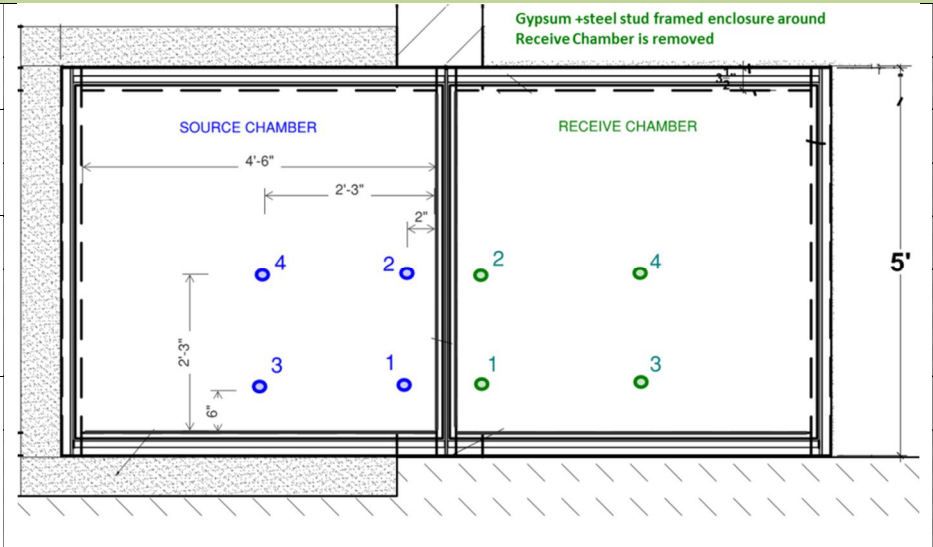

TABLE D- 6: [C_v] SOURCE AND RECEIVER RESULTS, 5 SEC DB L_{Leq}

D.3.4 [D_v] Ph3 - Vibration Measurement Results

The 5 sec dB L_{Leq} at the source and receiving chambers for the [D_v] test rig are summarized (Table D-7).

Test	L _{Leq} 5 sec, dB	Axis	[Surface Material] Accelerometer Location
[D _v] S5	102	Z	[glass] 6" above horizontal mullion, 2'-3" from vertical mullion
[D _v] R5	90		
[D _v] S6	102	Z	[glass] 2'-3" above horizontal mullion, 2'-3" from vertical mullion
[D _v] R6	91		
[D _v] S7	101	Z	[glass] 6" above horizontal mullion, 2" from vertical mullion
[D _v] R7	90		
[D _v] S8	102	Z	[glass] 2'-3" above horizontal mullion, 2'-3" from vertical mullion
[D _v] R8	92		
[D _v] S9	--	Z	Same as above (ambient measurement)
[D _v] R9	--		
[D _v] S10	88*	Z	Same as above (impulse measurement: tap on glass mid bay center) *L _{Lmax}
[D _v] R10	67*		

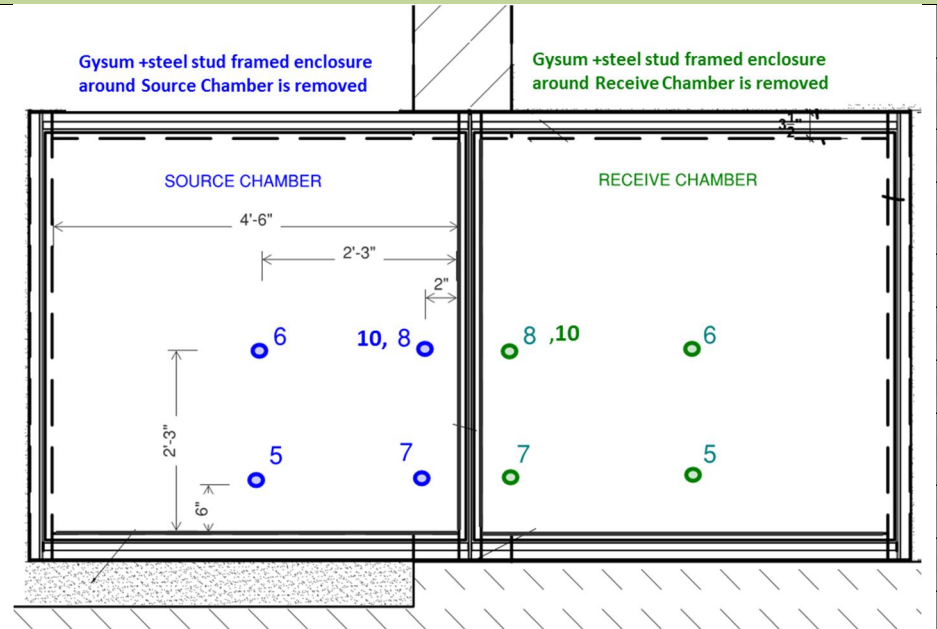

TABLE D- 7: [D_v] SOURCE AND RECEIVER RESULTS, 5 SEC DB L_{Leq}

D.4 VIBRATION ANALYSIS

A preliminary analysis investigation is summarized for the vibration measurement configurations **EV1** [A_v] and **EV2** [B_v]. Configurations **EV3a** [C_v] and **EV3b** [D_v] are not included in this analysis.

The initial analysis includes the conversion of the measured vibration acceleration levels in dB (re 10⁻⁶ m/s²) at curtain wall surfaces to sound pressure level in dB (re 20 μPa).

D.4.1 Measurement EV1 [A_v] and EV2 [B_v].

Measurements locations for the configurations used in the analysis are identified (Table D -8).

CURTAIN WALL SURFACE	EV1 [A _v] Figure D-5 Accelerometer Location (Measurement)	EV2[B _v] Figure D-5 Accelerometer Location (Measurement)
LOWER HORIZONTAL MULLION	2 (EV1_3R-02)	2 (EV2_3R-02)
VERTICAL MULLION	8 (EV1_3R-08)	5 (EV2_3R-05)
GLASS	3 (EV1_3R-03)	3 (EV2_3R-03)

TABLE D- 8: SELECTED VIBRATION MEASUREMENTS FROM TEST EV1 AND EV2

Below are elevations of the curtain wall bay that correspond with the accelerometer measurements identified in Table D-8.

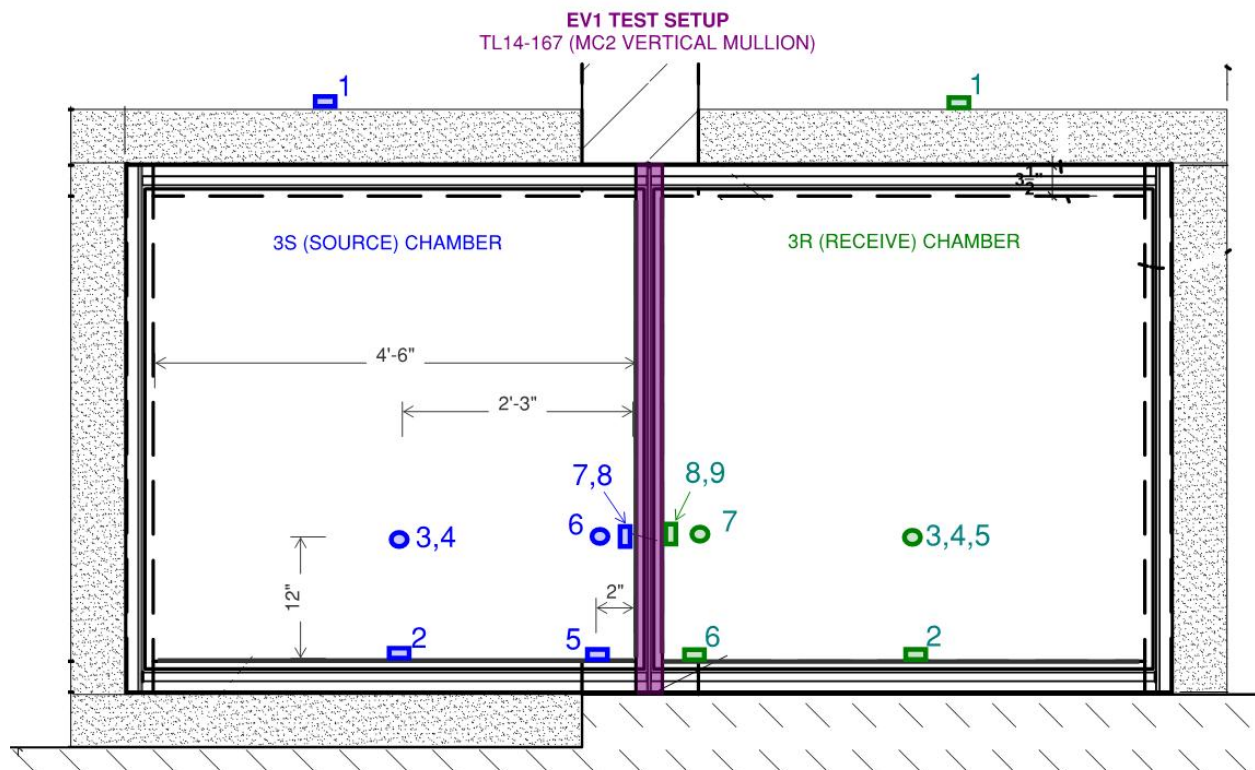

FIGURE D- 5: EV1 [A_v] Curtain Wall Elevation with 3R Chamber Accelerometer Locations 02, 08, 03

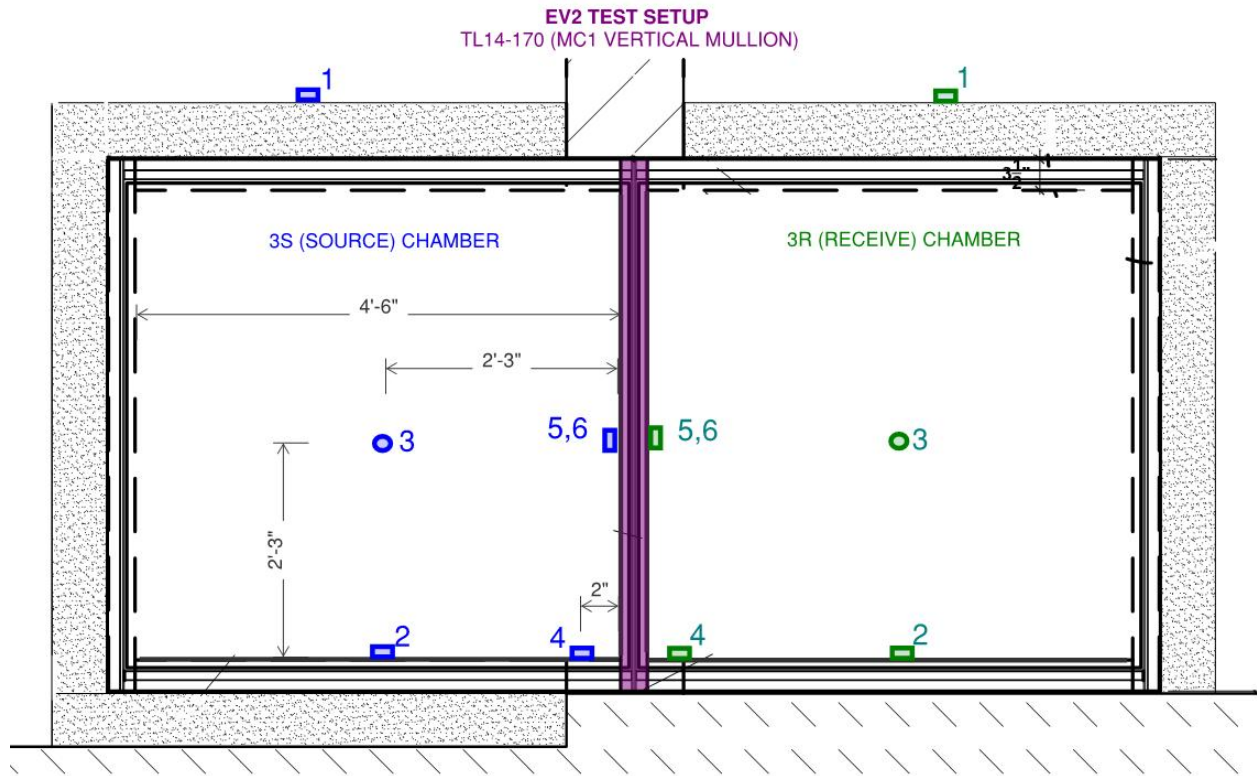

FIGURE D- 6: EV2 [B_v] Curtain Wall Elevation with 3R Chamber Accelerometer Locations 02, 05, 03

D.4.2 Calculation Procedure

Vibrational Acceleration Levels (dB) are converted to Sound Pressure Levels (dB) based on the following calculation procedure described.

- [1] Vibration Acceleration Levels (dB) measured at WEAL with the B&K 2260 meters (Table D-4 and Table D-5).
- [2] Data results in dB from [1] were converted to acceleration(*a*), in m/s^2 using the following equation:

$$a = a_0 * \left(10^{\frac{dB}{20}}\right)$$

Where,

EQUATION D-1

$$a_0 = (9.8 * 10^{-6}) m/s^2$$

- [3] Acceleration is converted to velocity (v) in (m/s) using angular frequency per One-third Octave Band Center Frequency.

$$v = a/\omega$$

Where,

$$\omega = 2\pi f$$

$f = \text{frequency (Hz)}$

EQUATION D-2

- [4] Velocity is then converted to pressure (p) in pascals using the following equation:

$$p(x) = 407 \text{ rayls} * v$$

EQUATION D-3

- [5] Pressure is converted to sound pressure level (L_p) in (dB) using

$$L_p(dB) = 20 \text{ LOG}\left(\frac{p}{2 * 10^{-5}}\right)$$

EQUATION D-4

- [6] Sound pressure level (L_p) is converted to sound power level (L_w) using

$$L_w(dB) = L_p + 10 \log(\text{area}, m^2)$$

EQUATION D-5

- [7] Sound power level is logarithmically added for the 3 elements measured, at the sill, mullion and glass:

$$L_w(dB) = 10 \log\left(10^{\frac{\text{sill}}{10}}\right) + 10 \log\left(10^{\frac{\text{mullion}}{10}}\right) + 10 \log\left(10^{\frac{\text{glass}}{10}}\right)$$

EQUATION D-6

- [8] Sound power level is converted to reverberation sound pressure level in the room: Reverberant Sound Level (from RT) - $L_{p,rev}$ from L_w

$$L_p(\text{reverberant}) = L_w - 10 \log V + 10 \log RT = 10 \log N + 14$$

EQUATION D-7

Where,

V is the room volume (m^3)

RT is the reverberation time (s)

N is the number of power sources (L_w contributing to the reverberant field)

D.4.2.1 Acceleration Level (dB) to Acceleration (m/s²)

$$L_a(dB) = 20 \log \left(\frac{a}{a_0} \right)$$

Where,

$$a_0 = (9.8 * 10^{-6}) \text{ m/s}^2$$

EQUATION D-8

D.4.3 Graphed Results of Conversions

Results based on Equations D-1 through Equation D-8 are graphed for systems EV1 and EV2.

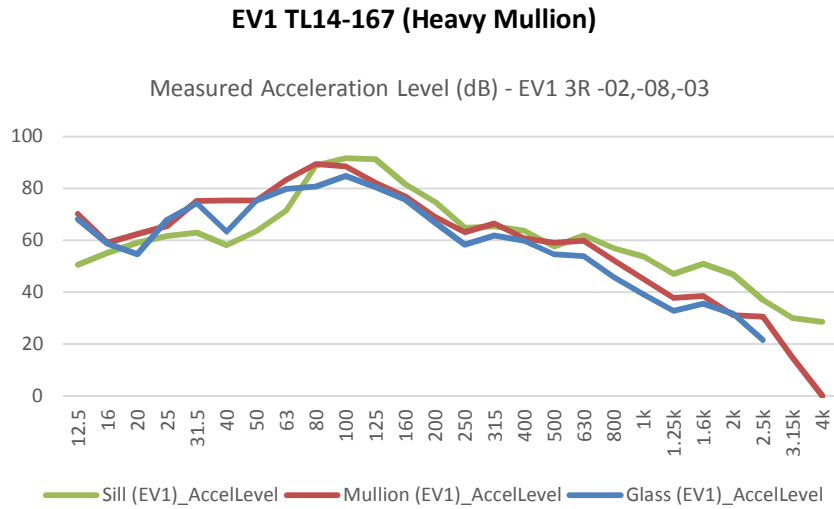

FIGURE D- 7: EV1 – MEASURED ACCELERATION LEVELS (DB)

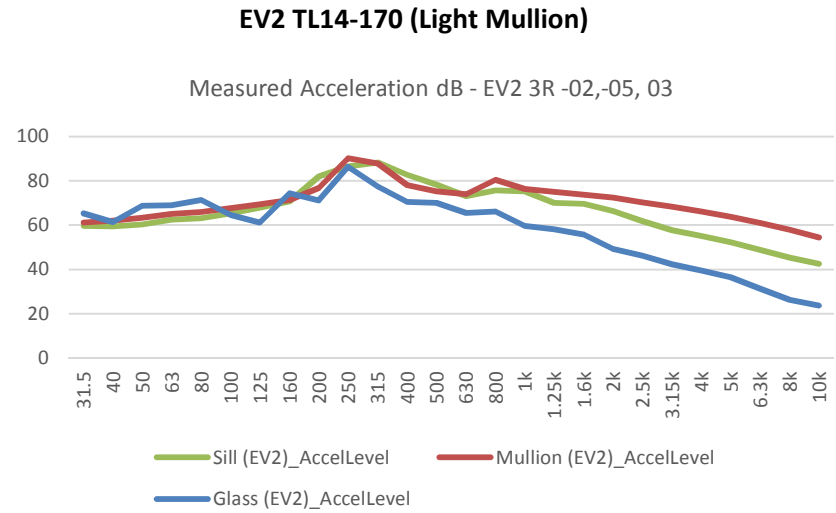

FIGURE D- 8: EV2 – MEASURED ACCELERATION LEVELS (DB)

EV1 TL14-167 (Heavy Mullion)

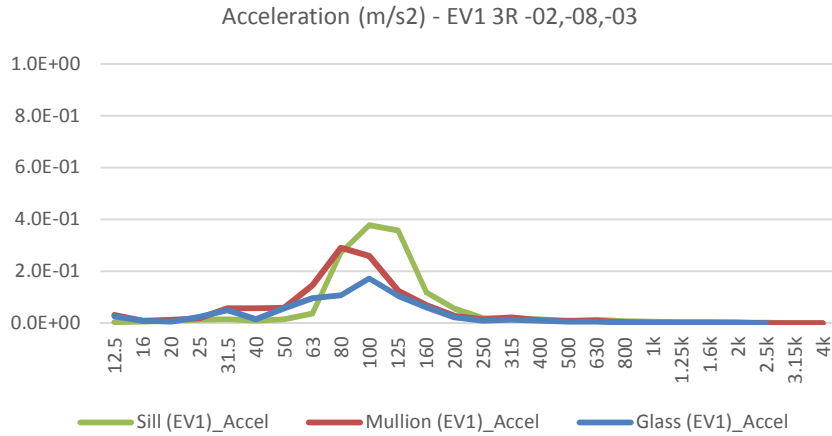

FIGURE D- 9: EV1 – CALCULATED ACCELERATION (M/S²)

EV2 TL14-170 (Light Mullion)

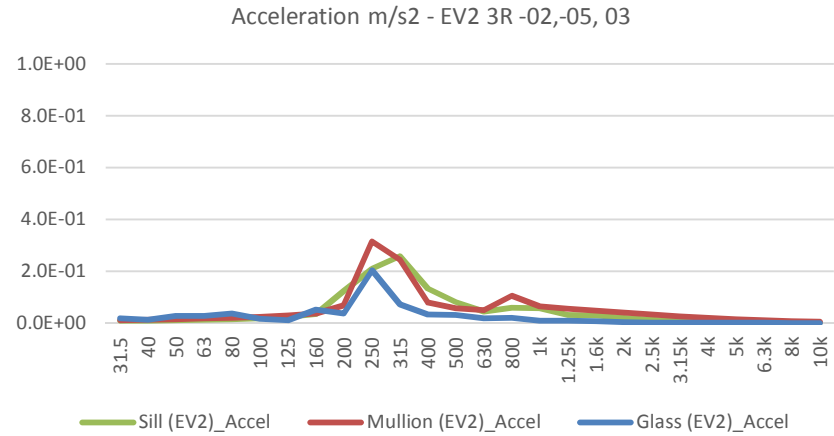

FIGURE D- 10: EV2 – CALCULATED ACCELERATION (M/S²)

Velocity (m/s) - EV1 3R -02,-08,-03

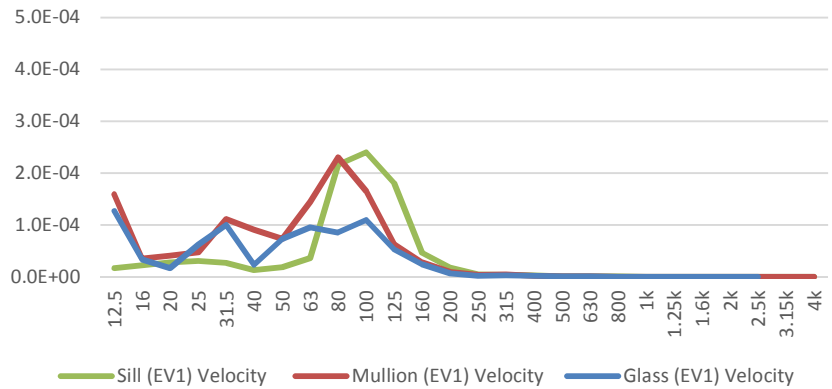

FIGURE D- 11: EV1 – CALCULATED VELOCITY (M/S)

Velocity m/s - EV2 3R -02,-05, 03

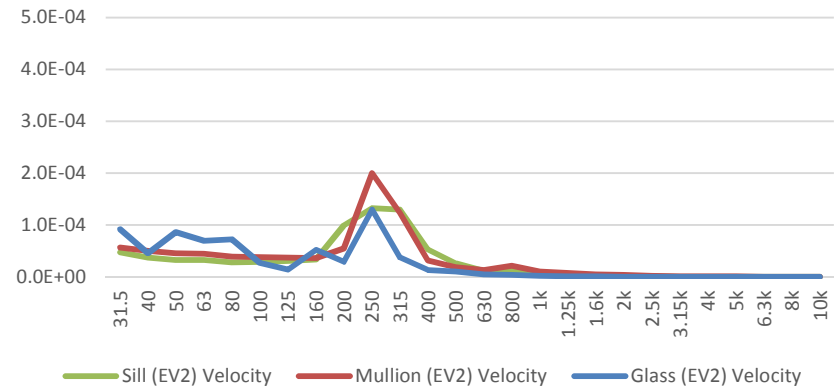

FIGURE D- 12: EV2 – CALCULATED VELOCITY (M/S)

EV1 TL14-167 (Heavy Mullion)

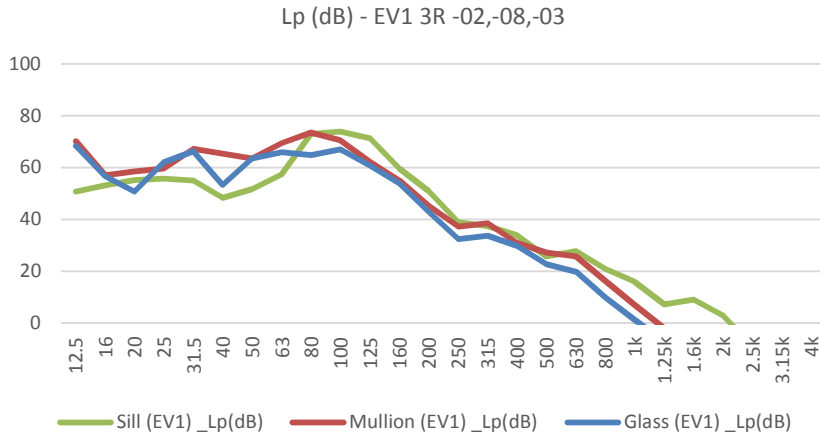

FIGURE D- 13: EV1 – CALCULATED SOUND PRESSURE LEVEL (dB)

EV2 TL14-170 (Light Mullion)

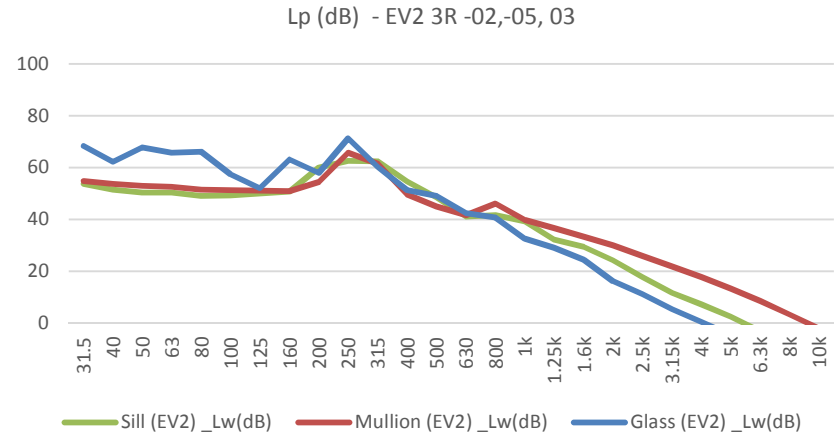

FIGURE D- 14: EV2 – CALCULATED SOUND PRESSURE LEVEL (dB)

Lw (dB) - EV1 3R -02,-08,-03

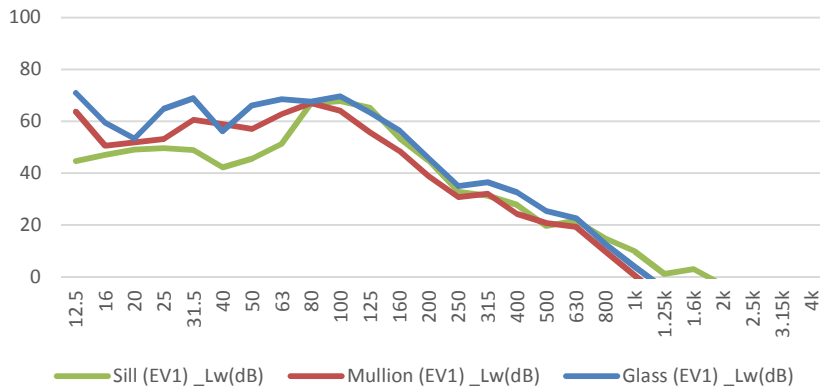

FIGURE D- 15: EV1 – CALCULATED SOUND POWER LEVEL (dB)

Lw (dB) - EV2 3R -02,-05, 03

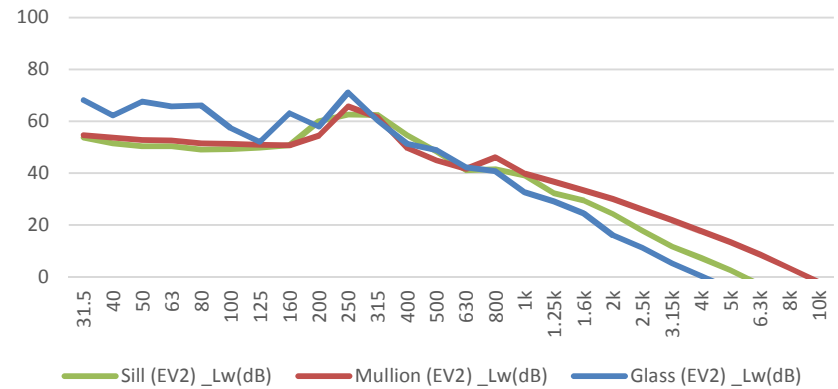

FIGURE D- 16: EV2 – CALCULATED SOUND POWER LEVEL (dB)

D.4.4 Analysis Summary

The resultant sound power and sound pressure levels are summarized at the receiving chamber (Table D – 9).

TEST SETUP	MEASUREMENT NO.	PREDICTED LEVELS					MEASURED
		Lw (dB) SILL	Lw (dB) MULLION	Lw (dB) GLASS	Lw (total dB)	Lp rev (total dB) ¹	Lp rev (dB) ²
EV1	EV1 3R-02,-08,-03	71.7	71	76	78.3	78	65.6
EV2	EV2 3R-02,-05,03	67	68	75	76.4	75.9	79.5

TABLE D- 9: SELECTED VIBRATION MEASUREMENTS FROM TEST EV1 AND EV2

¹ ($L_{p \text{ predicted}}$) with calculation procedure

² ($L_{p \text{ measured}}$) in the receiving chamber during the ASTM E90 measurements.

The predicted sound pressure levels ($L_{p \text{ predicted}}$) are compared to the measured sound pressure level ($L_{p \text{ measured}}$) (Figure D-17 and Figure D-18). The results are inconclusive and subject to further study.

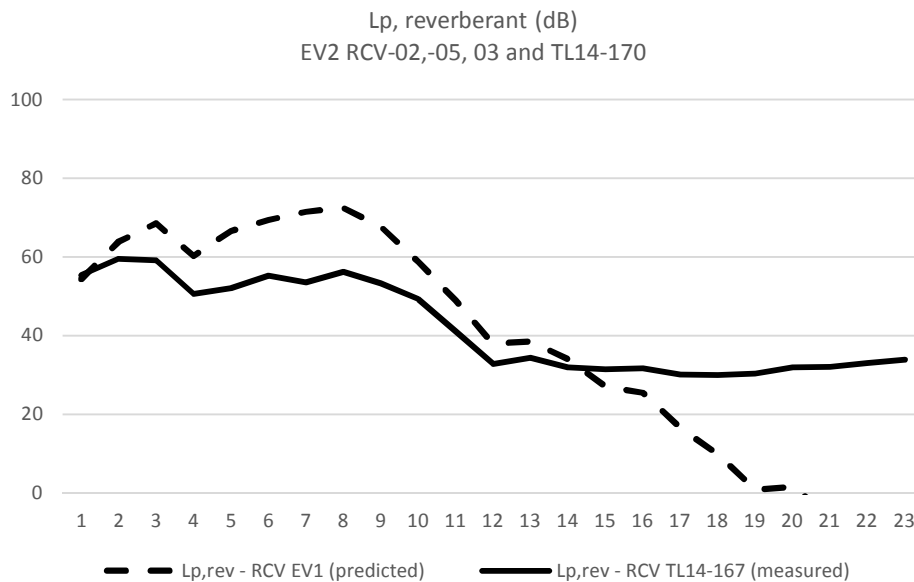

FIGURE D- 17: EV1, PREDICTED AND MEASURED SOUND PRESSURE LEVELS

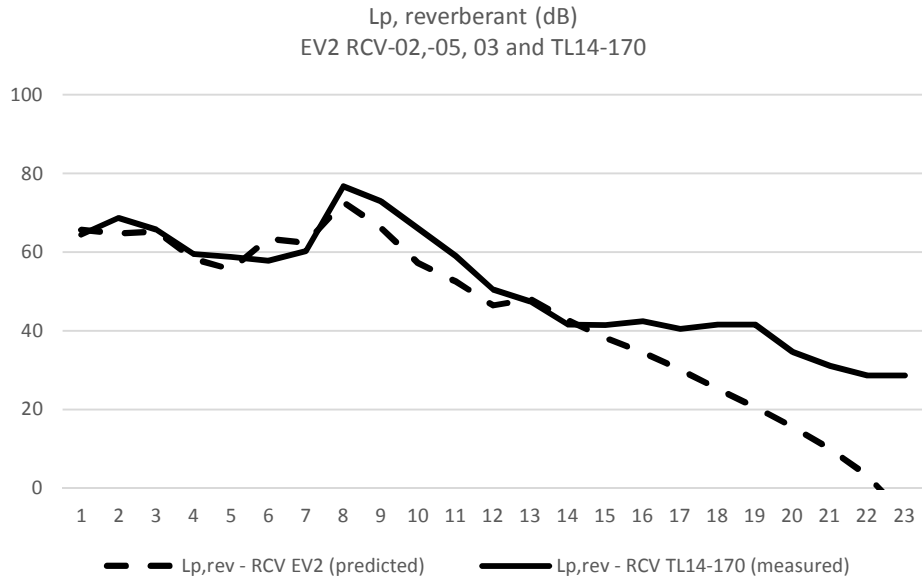

FIGURE D- 18: EV2, PREDICTED AND MEASURED SOUND PRESSURE LEVELS

D.5 VIBRATION MEASUREMENT SUMMARY

The converted sound power levels (dB re 10^{-12} W) from vibration acceleration levels (dB re 10^{-6} m/s²) at the receiving chamber for the glass, vertical and horizontal mullion are shown (Figure D-19).

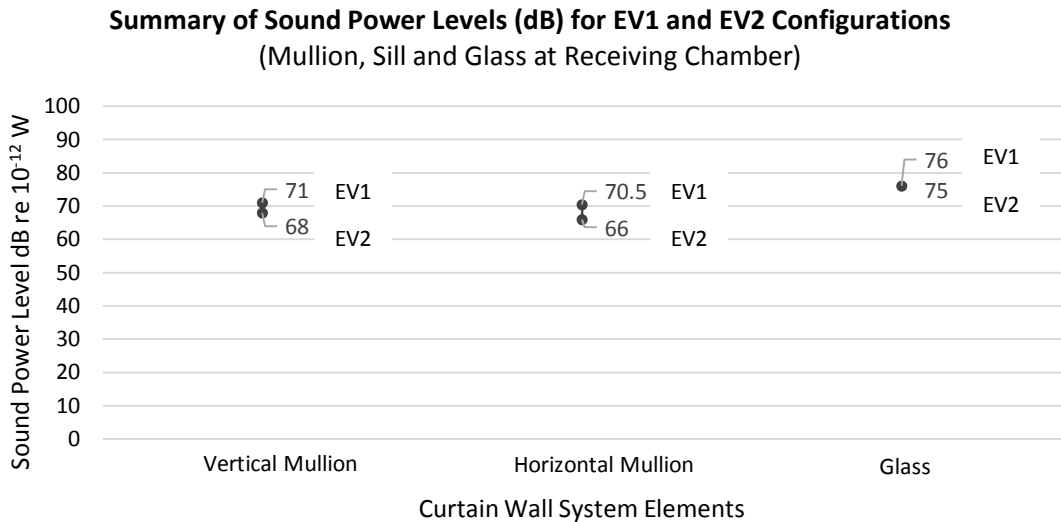

FIGURE D- 19: SUMMARY OF SOUND POWER AT EACH UVM MEASURED DURING PHASE 3

The vibration acceleration levels (dB re 10^{-6} m/s²) measured at the vertical and horizontal mullion indicate higher levels of acoustic energy at the receiving chamber than the glass.

Converting these vibration levels to sound power (dB re 10^{-12} W) and correcting for the surface area of each element, the highest level is at the glass. This indicates that the largest excited surface at the receiving chamber (i.e. glazing) may be the dominating sound flanking path.

The analysis from the vibration measurements provides preliminary insight to what element contributes most to the energy transmission of the curtain wall system. This work is subject to future refinement and development in future studies.