

# **A Method to Predict Reverberation Time in Concert Hall Preliminary Design Stage**

A Dissertation  
Presented to  
The Academy Faculty

by

Yan Zhang

In Partial Fulfillment  
of the Requirements for the Degree  
Doctor of Philosophy in the  
College of Architecture

Georgia Institute of Technology  
December, 2005

# **A Method to Predict Reverberation Time in Concert Hall Preliminary Design Stage**

Approved by:

Godfried Augenbroe, Advisor  
College of Architecture  
*Georgia Institute of Technology*

R. Lawrence Kirkegaard  
President, Principal Acoustician  
*Kirkegaard Associates*

Dr. Ruchi Choudhary  
College of Architecture  
*Georgia Institute of Technology*

Dr. Yves Berthelot  
School of Mechanical Engineering  
*Georgia Institute of Technology*

Dr. Brani Vidakovic  
School of Industrial and Systems Engineering  
*Georgia Institute of Technology*

Dr. Ning Xiang  
School of Architecture  
*Rensselaer Polytechnic Institute*

Date Approved: August, 12, 2005

*Dedicated to the intellectual curiosity  
that keeps me motivated and entertained*

## Acknowledgements

It has been four years since I stepped out of the plane and was confused about everything in this different country. Thanks to the PhD program, advisors, mentors and friends, my journey has been rich and rewarding.

My thesis advisor, Fried Augenbroe, had the most significant impact on my academic path. He led me into many exciting fields, taught me to be patient and critical about my own work, and encouraged me to go for my dream. He picked sensible sparkles in my wild thoughts, supplied them with firework, and let them glow. I am thankful for his support, ranging from help in funding to taking care of my important form when I predictably forgot. His perfect balance of intelligence, wisdom, and sense of humor make him a great advisor and a fun friend.

I also benefit from other mentors and friends in our program. I enjoyed the intellectual depth of morphology and exercised to be both analytical and creative in John Peponis' classes. His insights about design and space, delivered with wit and rigor, are always very inspiring for me. Through Chuck Eastman's classes I developed understandings in data model, which had implicit but natural influence in my work. His concise comments always lead me to intellectual contemplation, and motivate me to do better work. Through Doctor Seminar by Craig Zimring I was encouraged to think like an independent researcher. I enjoyed keen comments from Sonit Bafna all the time. I appreciate Ruchi's interest in my work, time to correct my grammars, writing suggestions and her hard working attitude. I thank Chuck as the director of our PhD program for providing the great academic environment, and what I learned here will be always with me in the future.

Having my dissertation blessed by Larry Kirkegaard is one of the most important highlights in my PhD journey. Larry's sharp, insightful yet warm comments helped me to improve my dissertation and shape my future research direction. After my defense Larry offered me opportunity to attend a unique "Hard Hat" tuning concert in Omaha Performance Center. I had chance to observe many backstage tuning activities, and more importantly, enjoyed even the softest touch and twist of the sound carried by the rich acoustics of the auditorium in its informal debut. The aural feast was truly enjoyable. I thank Rogene and Larry for the warm, pleasant and encouraging conversations. I am grateful for Scott Pfeiffer, Jake Ament, Zackery Belanger, Molly Norris, Tim Gulsrud and other crews in Kirkegaard associates for being helpful and friendly. I also appreciate the help from Lily Wang and Rebecca when I toured University of Nebraska Lincoln for the scale model of the Omaha Performance Center.

I thank Ning Xiang, director of Architectural Acoustics in Rensselaer Polytechnic Institute, for taking time to travel to Atlanta right after a busy conference in Brazil. His encouraging comments further boost my confidence, and his suggestions on relevant literature readings helped me to better understand specific topics.

This work might have not been possible without the excellent faculty resource in Georgia Tech in other disciplines. In Spring, 2001, I took a great class with Prof. Brani Vidakovic and had chance to further work with him on wavelet encryption and image processing. I was fascinated by the orthogonal decomposition idea, and was driven to take quite a few great classes. With Brani and other mathematicians as tour guides, my intellectual journey in this wonderland was marvelous. I also owe Brani gratefulness for the application of Bayesian method in this dissertation.

Many thanks go to Dr. Yves Berthelot, a quick-witted intelligent physicist. His class got me started in true understandings in acoustics and further inspired my research interest. His suggestion in very specific readings helped me to develop the theoretical depth of my current and possible future work. I view him as a respectable mentor and admire his intelligence and neat working style. It has been and will always be delightful to learn from him.

I am thankful for GSA and Steelcase for their funding support in the past four years. In GSA project I learned many things by working with Fried. In Steelcase I enjoyed the fabulous energy and creativity by working with John Peponis, Craig Zimring, Sonit Bafna and Mahbub Rashid.

I thank Fried and our PhD program for funding support to get access to ODEON simulation software. I'd like to thank our PhD program, Fried, and our college for funding me to attend 10dbmc and ASA conferences, where I got to know many interesting research and great people. I particularly thank Chuck Eastman and the PhD program for funding me the case study trip to Omaha.

I enjoyed the supportive environment provided by the Ph.D. program, our college and our university. I thank Mercedes Saghini for being a very helpful academic assistant and a sweet friend. I thank Donghoon for being a great homework teammate, Tuba for her critiques as a statistician, Ghang, Donghoon and Frank for their help in web programming, Ghang, Moon and Pati for their advices as senior students – especially for Ghang's format template, Mate, Mahbub and Moon for tolerating my disturbance when I am randomly bored. I had a relaxing wonderful time in our routine PhD potluck parties with faculty members and colleagues. I also enjoyed those gatherings with Fhemi Dogan

& Jenny Couch, Frank & Liyan, Ghang & Sungjin, Donghoon, Ranah, Tuba, Elif, Chunheng, Julie, Tifei, Kem, Mayank, Anjali, Gayle, Marietta, Ayse, Young&Bo, Hyung, Dida, Gelsy, Devon and other friends.

The personal life of an absent-minded idiot would have been a disaster without friends. I'd like to thank Loping, Mahbub and Mercedes for rescuing me when I was locked out of office in the midnight. I'd like to thank Fhemi, Rahul and Frank for taking me to the road driving test three times – I remember your help whenever I pass Monore test center. I'd like to thank Mayank, Mate, Frank, Julie, Tifei, Rahul, Haibin, Patricia for their help when I forgot my luggage right before the Paris flight, when I lost my itinerary and forgot my hotel name in a trip, when I forgot where I parked, when my car got stuck in the midnight for no humanly understandable reason, when I filled my car with Diesel, when my car hit or was hit by something, when I ran into all road damages in Atlanta and had my tires flattened numerous times. As a lazy Garfield cat from time to time I am also thankful for Patricia, Rahul, Haibin and Mi for being the best chefs in the world.

All in all, the world has been sunny surrounded by people who share my tears and laughter. They bless my dreams when I fly, even just with fantasy bubbles, and help me to heal my broken nose when I bump into rough surfaces with geometrical irregularities of non-negligible magnitudes. Names included or not, I am indebt to mentors, colleagues, family and friends who guide me, support me and light up my life.

Finally, I want to express my gratefulness to intellectual splendors created by great people, and forever admire creative efforts to make the world look and sound better. For me life is beautiful owing to any level of resonances with them.

# Table of Contents

Acknowledgements .....	iv
List of Tables .....	xii
List of Figures .....	xiv
List of frequently used symbols.....	xvii
List of Abbreviations.....	xx
Summary.....	xxi
CHAPTER 1. Introduction.....	1
1.1 Concert Hall Design based on Myth.....	2
1.2 Concert Hall Design based on Precedents.....	6
1.3 Concert Hall Design based on Science.....	10
1.4 Architectural Acoustics and Modern Concert Hall Design.....	12
1.5 Research Scope.....	15
1.6 Research Method.....	15
CHAPTER 2. Reverberation Time.....	19
2.1 Concert Hall Acoustic Performance Index.....	20
2.2 Reverberation Time and Music Appreciation.....	24
2.3 Sound Frequency and Reverberation Time.....	27
2.4 Reverberation Time Position Variability.....	30
2.4.1 Theoretical Study.....	30
2.4.2 Measurement Data.....	32
2.5 Reverberation Time Measurement.....	34
2.5.1 Measurement Principles.....	34
2.5.2 Reverberation Time vs. Other Indexes.....	38
2.6 Conclusion.....	39
CHAPTER 3. Current Reverberation Time Prediction Model.....	40
3.1 Sound Propagation and Wave Theory.....	40



3.1.1 Reflection.....	40
3.1.2 Absorption.....	41
3.1.3 Diffraction and Scattering Effect.....	44
3.2 Scale Model Experiments.....	46
3.3 Wave Theory and Room Modes.....	48
3.4 Geometrical Room Acoustics: Simulation Software.....	50
3.5 Geometrical Room Acoustics: Sabine Equation.....	53
3.6 Geometrical Room Acoustics: Models with Modifications.....	54
3.6.1 Eyring Method.....	55
3.6.2 Kuttruff's Modification.....	56
3.6.3 Millington's Method.....	57
3.6.4 Zhang's Method.....	58
3.7 Geometrical Room Acoustics: Methods Based on Rectangular Enclosure....	59
3.7.1 Fitzroy's Equation and Neubauer's Modification.....	59
3.7.2 Arau-Puchades' Method.....	60
3.8 Summary on Geometrical Room Acoustics Methods.....	61
3.9 Empirical Approach.....	63
3.10 Semi-empirical Approach.....	64
 CHAPTER 4. Concert Hall Geometry and Reverberation Time.....	 67
4.1 Concert Hall Shapes.....	68
4.2 Necessity of Shape Influence Modifications.....	72
4.3 Empirical Model for Free Path Length Variance.....	74
4.3.1 Shoebox Shape.....	78
4.3.2 Extruded Shape – Right Prism.....	81
4.3.2.1 Cylinder and Elliptical Cylinder.....	82
4.3.2.2 Triangular Prism.....	84
4.3.2.3 Right Prism.....	87
4.4 General Shape.....	90
4.5 Conclusion.....	92

CHAPTER 5. Non-Uniform Material Assignment and Reverberation Time.....	94
5.1 Method Evaluation.....	95
5.2 Adjustment for Practice.....	98
5.3 Comparison with Simulation.....	100
5.3.1 Kuttruff Method.....	101
5.3.2 Comparison between Arau-Puchades and Fitzroy Methods.....	102
5.4 Conclusion.....	105
 CHAPTER 6. Scattering Effect.....	 106
6.1 Concert Hall Interior Surface Diffusivity .....	106
6.2 Surface Diffusivity and Wave Length.....	109
6.3 Analytical Solutions.....	112
6.4 Scattering Coefficient Estimation.....	114
6.5 Simplified Model.....	117
 CHAPTER 7. Model Structure.....	 120
7.1 Simplified Model Structure.....	120
7.2 Surface Irregularity Scale.....	123
7.3 Statistical Model.....	125
 CHAPTER 8. Calibration Method.....	 127
8.1 Bayesian Analysis.....	128
8.2 Software Tool.....	130
 CHAPTER 9. Parameter Value and Uncertainty Assessment.....	 132
9.1 Measurement Error.....	132
9.1.1 Measurement Error at One Specific Location.....	132
9.1.2 Overall Measurement Error Assessment.....	134
9.2 Material Property Uncertainty.....	135
9.3 Initial Distribution of $d$ .....	140

CHAPTER 10. Model Calibration and Validation.....	141
10.1 Model Calibration.....	141
10.2 Model Validation.....	142
CHAPTER 11. Conclusion.....	145
11.1 Summary.....	145
11.2 Contribution.....	145
11.3 Limitation.....	147
11.4 Future Work.....	148
APPENDIX A. COLEMAN’S FORMULA.....	149
APPENDIX B. TECHNICAL DESCRIPTION OF GROSSER MUSIKVEREINSSAAL HALL.....	150
REFERENCES.....	152
VITA.....	163

## List of Tables

Table 2.1 Recommended occupied reverberation time .....	26
Table 2.2 Position variability in 11 halls measured by Peloson et al.....	32
Table 2.3 Position variability in Ferst Center of Art, Atlanta.....	33
Table 3.1 Comparison of different methods.....	61
Table 4.1 Comparison between a sphere and a rectangle.....	73
Table 4.2 Comparison between a cylinder and its containing box.....	83
Table 4.3 Simulation data for the triangular prisms.....	86
Table 4.4 Comparison between actual values and model predictions for the vineyard plan .....	87
Table 4.5 Comparison between actual values and model predictions for the horseshoe plan.....	88
Table 5.1 Comparison among three methods.....	95
Table 5.2 Comparison between Kuttruff prediction and ODEON result for diffusive surfaces settings.....	102
Table 5.3 Comparison among Arau-Puchades, Fitzroy predictions and ODEON simulation for a Box of proportion 1:1:1.....	103
Table 5.4 Comparison among Arau-Puchades, Fitzroy predictions and ODEON simulation for a Box of proportion 1:1:2.....	103
Table 5.5 Comparison among Arau-Puchades, Fitzroy predictions and ODEON simulation for a Box of proportion 1:2:2.....	104
Table 6.1 Technical Parameters of Boston Symphony Hall.....	110
Table 6.2 Measured reverberation time for Boston Symphony Hall.....	111
Table 6.3 Predicted reverberation times with Kuttruff and Fitzroy methods.....	111
Table 6.4 Estimated diffusive proportion.....	116
Table 7.1 Hann and Frick's Assessment Method.....	123

Table 7.2 Recommended values for geometrical scale estimation.....	124
Table 9.1 Empirical Measurement Data Format (Beranek, 2004).....	132
Table 9.2 Measurement error for 6 repetitive measurements.....	133
Table 9.3 Measurement error for 30cm variation of source-microphone position.....	133
Table 9.4 Measurement error for Dodecahedron 45cm with stepwise rotation .....	134
Table 9.5 Measurement error for Cube 16cm Edge with stepwise rotation.....	134
Table 9.6 Measurement Error Estimation.....	134
Table 9.7 Measurement error of seven teams with different equipments.....	135
Table 9.8 Audience absorption coefficient by Kahn and Kuhl.....	137
Table 9.9 Strip width to compensate the edge effect.....	137
Table 9.10 Standard deviation of audience absorptive coefficients.....	138
Table 9.11 Absorptive coefficient without audience (Beranek and Hidaka 1998).....	138
Table 9.12 Standard deviation of material absorptive coefficients.....	139
Table 10.1 Halls used for calibration purpose.....	141
Table 10.2 Comparison between measurements and predictions.....	144
Table B.1 Technical Parameters of Grosser Musikvereinssaal Hall (Beranek, 2004)...	150

## List of Figures

Figure 1.1 Buildings with acoustics of the open air, derived from the classical amphitheater (Johannes Bochius, 1595).....	2
Figure 1.2 Theatre of Vitruvius, from Athanasius Kircher, Phonurgia Nova (Hunt, 1992) .....	4
Figure 1.3 The temple of music, an imaginary edifice designed around music symbolism (Robert Fludd, 1618).....	4
Figure 1.4 Markgrafliches Opernhaus, Bayreuth, by Giuseppe and Carlo Calli-Bibiena (Forsyth, 1985).....	6
Figure 1.5 Neues Gewandhaus, Leipzig, by Martin Gropius and Heinrich Schmieden, colored woodcut engraving by E.Limmer.....	6
Figure 1.6 Opera Garnier, photograph from 1895 (Forsyth, 1985).....	8
Figure 1.7 Relevant scale of Eszterhaza hall and King's theatre (Meyer, 1978).....	9
Figure 1.8 Illustration from Athanasius Kircher to demonstrate the focal effects (Hunt, 1992).....	11
Figure 2.1 Sound propagation in concert hall (Beranek, 2004).....	22
Figure 2.2 Reverberation time and ITDG (Beranek, 2004).....	22
Figure 2.3 Recommended Reverberation time (Wilson, 1989).....	27
Figure 2.4 Sound wave forms (Taylor, 2000).....	28
Figure 2.5 Spectrum of the clarinet in its middle range, fundamental frequency 415Hz (Barron, 1993).....	29
Figure 2.6 Frequency range of music instruments (Pierce, 1981).....	30
Figure 2.7 Reverberation time distribution with different distribution of absorptive materials (Kuttruff, 1994).....	32
Figure 2.8 Equipment Sabine used to explore reverberation time (Thompson, 2002)...	34
Figure 2.9 Reverberation time measurement method (Kuttruff, 1999).....	35
Figure 2.10 Typical recorded decaying process (Kuttruff, 1999).....	35

Figure 2.11 Representation of decaying process (Wilson, 1989).....	36
Figure 2.12 Measurement uncertainties (Bork, 2002).....	38
Figure 2.13 Mean relative standard deviation in % of parameters measured by seven teams from independent labs (Lundeby and Vigran, 1999).....	38
Figure 3.1 Illustration on reflection from Athanasius Kircher's Phonurgia Nova .....	41
Figure 3.2 An early absorption material commercial in 1923 (Thompson, 2002).....	41
Figure 3.3 Closed and Open pore structure (Cox and D'Antonia, 2004).....	42
Figure 3.4 Typical constructions for Helmholtz absorber and membrane absorber (Cox and D'Antonia, 2004).....	43
Figure 3.5 Illustration of a single panel Schroeder Diffuser (Cox and Antonia, 2004)...	45
Figure 3.6 Scattering Effect Illustration (Cox and Antonia, 2004).....	46
Figure 3.7 Scale model for Atlanta Symphony Hall (Kirkegaard Associates).....	47
Figure 3.8 Excited frequency spectrum of a room (Mankovsky, 1971).....	50
Figure 3.9 Illustration of reverberation time prediction method.....	66
Figure 4.1 Typical concert hall shapes (Barron, 1993).....	69
Figure 4.2 Royal Albert Hall (Beranek, 2004).....	69
Figure 4.3 Boston Symphony Hall (Beranek, 2004).....	70
Figure 4.4 Berlin Philharmonic Hall (Beranek, 2004).....	70
Figure 4.5 Orchestra Hall in Chicago (Kirkegaard Associates website).....	71
Figure 4.5 Tokyo Opera City (Beranek, 2004).....	71
Figure 4.6 Free path length distribution for a rectangular enclosure 10*10*10m.....	72
Figure 4.7 Free path length distribution for a rectangular enclosure 4*30*30m.....	75
Figure 4.8 Free path length histogram generated by ODEON.....	76
Figure 4.9 Free path length variance.....	77

Figure 4.10 Residuals of the linear model.....	79
Figure 4.11 Comparison between real value and model prediction.....	79
Figure 4.12 Residual from Equation (4.3).....	80
Figure 4.13 Two distortion trends from rectangular shape.....	80
Figure 4.14 Description of a cylinder.....	81
Figure 4.15 Cross-section of a cylinder and the box containing it.....	82
Figure 4.16 Cross-section of a an elliptical cylinder.....	83
Figure 4.17 Description of a triangular prism.....	84
Figure 4.18 Empirical data of the triangular prisms.....	84
Figure 4.19 Fit the empirical data with BL.....	85
Figure 4.20 Model modification.....	86
Figure 4.21 Residual between the model and real value.....	86
Figure 4.22 Description of the Vineyard plan.....	88
Figure 4.23 Description of the Horseshoe plan.....	88
Figure 4.24 Description of the Fan plan.....	89
Figure 4.25 Free path length vs. $b/a$ .....	90
Figure 4.26 Illustration of the two stages.....	90
Figure 4.27 The geometrical representation for ODEON simulation.....	91
Figure 5.1 Comparison of the predictions of Kuttruff, Arau-Puchades, and Fitzroy equations.....	96
Figure5. 2 Christchurch Town Hall (Beranek, 2004).....	99
Figure 5.3 ODEON setup in scattering method.....	101
Figure 5.4 An Example used for Odeon simulation.....	102
Figure 5.5 Comparison between Kuttruff prediction and simulation result.....	102



Figure 5.6 Comparison among Arau-Puchades, Fitzroy predictions and ODEON simulation for a Box of proportion 1:1:1.....	104
Figure 5.7 Comparison among Arau-Puchades, Fitzroy predictions and ODEON simulation for a Box of proportion 1:1:2.....	104
Figure 5.8 Comparison among Arau-Puchades, Fitzroy predictions and ODEON simulation for a Box of proportion 1:1:2.....	105
Figure 6.1 Concert to celebrate the birth of the dauphin: oil painting by Giovanni Paolo Panini, 1729.....	108
Figure 6.2. Kleinhans Music Hall, Buffalo (Beranek, 2004).....	108
Figure 6.3 Boston Symphony Hall (Beranek, 2004).....	110
Figure 6.4 P value inferred by measurement data.....	112
Figure 6.5 Illustration of relevant relation among equivalent absorptive coefficient, Fitzroy prediction and Kuttruff prediction.....	112
Figure 6.6 Relevant magnitude of roughness and sound field (Ogilvy, 1991).....	115
Figure 6.7 Relative magnitude of diffusive proportion.....	117
Figure 8. 1 WinBUGS Text coding Interface.....	131
Figure 9. 1 Illustration of scattering effect (Ogilvy, 1991) .....	140
Figure 10.1 Calibration Result inferred from Winbugs.....	142
Figure 10.2 Grosser Musikvereinssaal, Vienna (Beranek, 2004).....	143
Figure 10.3 Comparison between measurements and predictions.....	144
Figure B.1 Plan drawings of grosser Musikvereinssaal Hall(Beranek, 2004).....	151

## List of Frequently Used Symbols

$A$	total absorption of a room ( $\text{m}^2$ )
$a_{en}$	modified average absorptive coefficient of enclosure other than ceiling
$a_{ac}$	modified average absorptive coefficient of ceiling, audience and stage
$a_x$	modified absorptive coefficient vertical to x axis
$a_y$	modified absorptive coefficient vertical to y axis
$a_z$	modified absorptive coefficient vertical to z axis
$B$	Surface irradiation strength ( $\text{W}/\text{m}^2$ )
$c$	Sound speed (m/s)
$d$	Parameter moderating magnitude between coherent and diffusive energy
$D_x$	Equivalent scattering coefficient on x axis
$D_y$	Equivalent scattering coefficient on y axis
$D_z$	Equivalent scattering coefficient on z axis
$E_0$	Initial sound energy (J)
$E(t)$	Sound energy at time t (J)
$f$	Frequency (Hz)
$F_i$	Scattering coefficient of surface $i$
$k$	wave number
$I$	Sound energy intensity ( $\text{W}/\text{m}^2$ )
$l$	free path length (m)
$\bar{l}$	Mean free path length (m)
$\overline{l^2}$	Mean of the square of the free path length (m)
$m$	Energy attenuation coefficient for absorption in air
$N$	Number of collisions one particle with surfaces
$N_i$	Number of collisions one particle with surface $i$
$\bar{n}$	Average collision frequency in unit time ( $\text{s}^{-1}$ )
$p$	Sound pressure (Pa)
$S$	Surface area of a room ( $\text{m}^2$ )
$S_c$	Area of ceiling ( $\text{m}^2$ )

$S_f$	Area of floor and stage (m <sup>2</sup> )
$S_w$	Area of side enclosure (m <sup>2</sup> )
$S_x$	Area of walls normal to coordinate $x$ (m <sup>2</sup> )
$S_y$	Area of walls normal to coordinate $y$ (m <sup>2</sup> )
$S_z$	Area of walls normal to coordinate $z$ (m <sup>2</sup> )
$S_i$	$i$ th Surface area (m <sup>2</sup> )
$t$	Sound particle travel time (s)
$T_{60}$	Reverberation time (s)
$V$	Volume (m <sup>3</sup> )
$V_{max}$	Maximum rectangle of this enclosure (m <sup>3</sup> )
$w$	Sound energy density (W.s/m <sup>3</sup> )
$w_0$	Initial sound power (W.s/m <sup>3</sup> )
$x$	Cartesian coordinate (m)
$x$	Shortest edge of rectangular enclosure (m)
$x_{max}$	Shortest maximum edge of rectangular enclosure (m)
$y$	Cartesian coordinate (m)
$y$	Middle edge of rectangular enclosure
$y_{max}$	Middle maximum edge of rectangular enclosure (m)
$z$	Cartesian coordinate (m)
$z_{max}$	Longest maximum edge of rectangular enclosure (m)
$\alpha$	Sound absorptive coefficient
$\bar{\alpha}$	Average absorptive coefficient
$\alpha_c$	Absorptive coefficient contributed by coherent sound field
$\alpha_d$	Absorptive coefficient contributed by diffusive sound field
$\alpha_{ac}$	Average absorptive coefficient of ceiling and audience and stage
$\alpha_{eq}$	Equivalent absorptive coefficient
$\alpha_{en}$	Average absorptive coefficient of all enclosure other than ceiling
$\alpha_{mmod}$	Absorptive coefficient after material assignment modification
$\alpha_{smod}$	Absorptive coefficient after shape modification

- $\alpha_x$  Average absorptive coefficient vertical to axis x
- $\alpha_y$  Average absorptive coefficient vertical to axis y
- $\alpha_z$  Average absorptive coefficient vertical to axis z
- $\lambda$  Wave length (m)
- $\rho$  Reflective coefficient
- $\bar{\rho}$  Average reflective coefficient
- $\gamma^2$  Variance of free path length
- $\gamma^3$  Third moment of free path length distribution

## **List of Abbreviations**

ACF	Auto correlation function
BR	Bass Ratio
EDT	Early decay time
IACC	Inter-aural cross correlation
ITDG	Initial time delay gap
LF	Lateral energy fraction
LG	Late lateral energy
RT	Reverberation time
STD	Standard deviation

## Summary

A historical review is performed to study the impact of acoustical knowledge on concert hall developments. It shows that although acoustics developed from myth to real science, there is still a gap between its fast growing knowledge and relatively slow applications to improve designs. There have been many successful innovative auditorium designs celebrating the integration of art and science (Beranek, 2004; Kirkegaard, 1999), but they are usually facilitated by experienced acousticians who master the essence of both architecture and acoustics. Architectural acoustics research and education shall help populating the tacit knowledge and experience of acousticians to reduce the gap between design and knowledge. The established paradigm in this field is to identify the performance goals of concert halls, recognize the available design information in different stages, and establish models to link them together. Placed in this general picture, this thesis focuses on providing design support for preliminary stage. It develops a model to link accessible design features with the most important acoustics performance index, reverberation time.

A literature review on existing reverberation time prediction methods shows that they are based on either too demanding or over-simplified for this stage. This study intends to develop a model that makes maximum use of available information and improves prediction accuracy in comparison with existing simplified methods. Through literature survey and data analysis, three factors (geometrical shape, non-uniform material distribution and scattering effect) are recognized as significant for reverberation time prediction.

On geometrical shape, Kuttruff derived an analytical formula introducing the free path length variance to account for its influence (Kuttruff, 1999, Arau-Puchades, 1988, Fitzroy, 1959). However, its applicability in engineering practice is limited by the difficulty in assessing this parameter. This thesis developed a simple method to estimate free path length variance through analysis on virtual experimental data with ODEON simulation software.

This thesis studies the influence of scattering effect and non-uniform material distribution, and states that scattering effect moderates the impact of non-uniform material distribution on reverberation time. Theoretical assumptions and prediction results of three popularly used equations addressing the non-uniform material distribution are studied. The author argues that they are only appropriate for surfaces of specific scattering coefficient ranges and therefore have limited applications. A case study on Boston Symphony Hall is used to demonstrate the necessity to integrate the two factors in model prediction. The difficulty in estimating scattering coefficients in practice is also discussed, and this thesis proposes a method to link the scattering coefficients with the surface diffusivity based on the structure of analytical solutions.

The final simplified model developed in this thesis integrates geometrical factor with a practical method, recognizes the interaction between non-uniform material distribution and scattering effect, and for the first time includes scattering effect in a simple analytical formula.

This model is further calibrated with empirical data. Considering the complicated uncertainty structures contained in empirical data, this thesis develops a hierarchical statistical model and uses Bayesian rather than traditional regression method to do

parameter estimation. The improved accuracy of the model is demonstrated by comparing its prediction with results from existing analytical equations and empirical measurements on Grosser Musikvereinssaal Hall.

In summary, this thesis developed a semi-empirical model to support concert hall preliminary design. The specific contributions of this thesis are the following:

- An appropriate parameter metric is recognized as significant for predicting concert hall reverberation time performance.
- “Scattering effect” is introduced for reverberation time prediction in a simple manner and a practical method is developed to estimate the frequency dependent scattering coefficients.
- A simple method is developed to estimate the “free path length variance” and thus make Kuttruff’s method applicable in practice.
- Bayesian method is used as an advanced method to handle the complicated uncertainties in empirical data for parameter estimation. Bayesian method has been successfully used in architectural acoustics domain to solve complicated parameter estimation and model selection problems (Xiang and Goggans, 2001, Xiang et al, 2005, Jasa et al, 2005). Its different but effective application in this thesis will help bring further awareness of research community on this advanced technique.



# **CHAPTER 1**

## **Introduction**

As a tribute to music and visual art, concert hall designs demand excellent sound quality, pleasant visual environment and architectural aesthetics. They are among the most challenging tasks for architects due to the multiple constraints in acoustics, visual sightlines, stage design, and the usual structural concern.

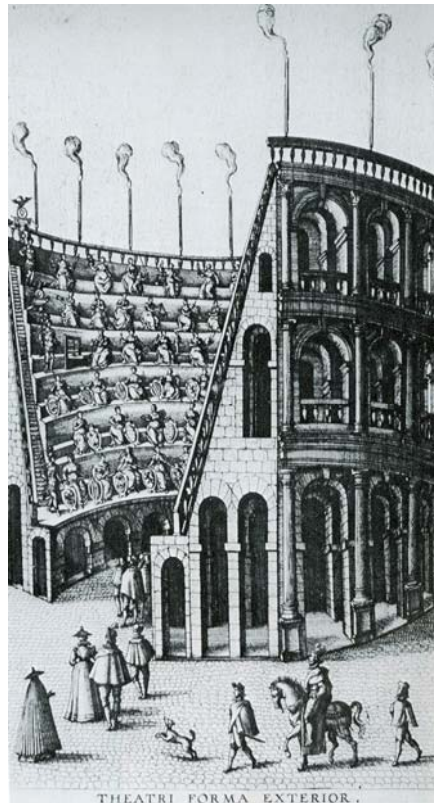
Historical research has shown that concert hall designs are significantly influenced by acoustics knowledge, social environment and contemporary architectural theory (Forsyth, 1985, Thompson, 2002). Section 1.1 through 1.3 summarizes the development of concert hall designs and acoustical knowledge, especially on the impact of knowledge on design in a historical context. Although there is no doubt that the development of scientific knowledge has fostered many successful innovative designs in past decades (Beranek, 2004, Kirkegaard, 1999, Hidaka et al., 2000, Gilbert - Rolfe and Gehry, 2002), a gap between the fast knowledge growth in acoustics and its relatively slow application in improving the concert hall designs is still observed.

Section 1.4 discusses that this gap shall be reduced by a performance based scientific framework, which has already set the tone as the research paradigm of architecture acoustics. What prevents the implementation of this approach is discussed. Section 1.5 proposes the research scope of this thesis to address this

barrier, and discusses how this work fit in the general performance based framework picture. Section 1.6 proposes the research method of this thesis.

## 1.1 CONCERT HALL DESIGN BASED ON MYTH

The ancient Greek and Roman open air amphitheaters provided an environment for both religious rites and music performance. The acoustical knowledge at that time was mostly rooted in empirical observations, intuition, symbolic and analogical thinking.



**Figure1. 1 Buildings with acoustics of the open air derive from the classical amphitheater (Johannes Bochius, 1595) (Forsyth, 1985)**

In Ten Books of Architecture - the earliest historical documents addressing theatre design - Vitruvius justifies the development of raking seats around the stage

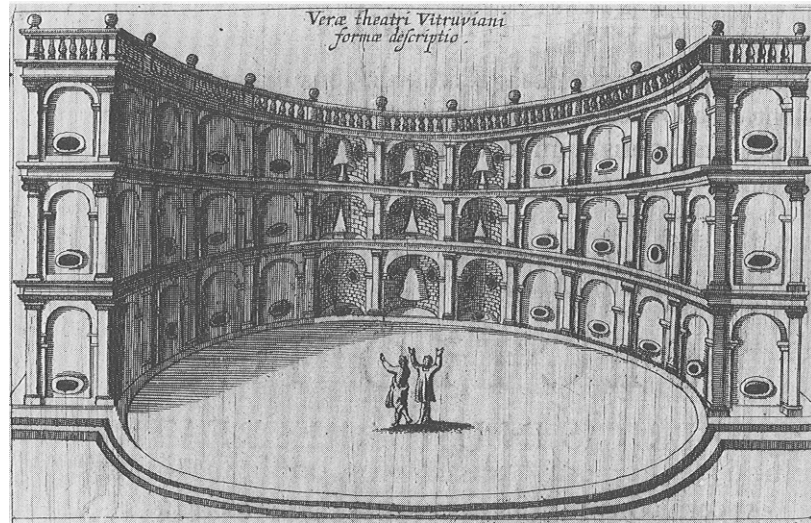
center by his understanding in sound propagation to “make every voice uttered on the stage come with greater clearness and sweetness to the ears of audience”. He wrote, “... the voice executes its movements in concentric circles; but while in the case of water the circles move horizontally on a plane surface, the voice not only proceeds horizontally, but also ascends vertically by regular stages... Hence the ancient architects, following in the footsteps of nature, perfected the descending rows of seats in theatre from their investigation of the ascending voice” (Vitruvius, 1960).

Although Vitruvius’s book contains valid wisdom and awareness, before the establishment of modern acoustics the history of music buildings design was influenced by all kinds of myths.

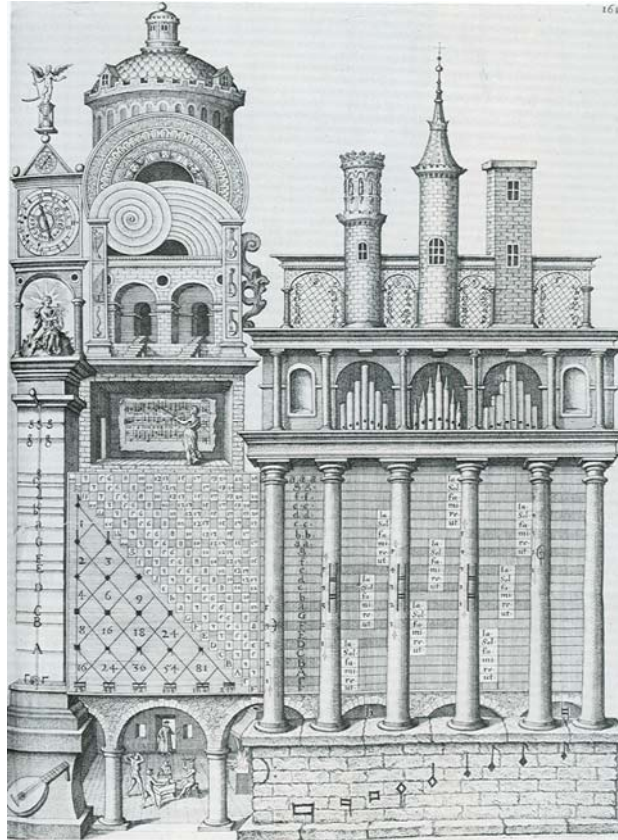
The earliest myth roots from the discovery of harmony in music. Vitruvius expressed his optimism by saying : “For just as musical instruments are brought to perfection of clearness in the sound of their strings by means of bronze plates or horn, so the ancients devised methods of increasing the power of the voice in theaters through the application of harmonics”(Vitruvius, 1960).

Thereafter, until Renaissance, many philosophers and architects believed that music was inherently linked to architecture through the underlying harmony of the universe. Originating from Pythagoras and Plato, the idea is that if simple proportions underlie the harmony of music, then it may also contain the divine cosmological order. The architecture representing this order will echo the sublime of the music being played. Figure 1.3 demonstrates a building designed centered on this philosophy. Otto von Simson summarized the essence of these ideas by

claiming that architecture was the mirror of eternal harmony, and music was its echo. (Padovan, 1999, Plato, 1957, Barron, 1993, Forsyth, 1985, Von Simson, 1962).



**Figure1. 2 Theatre of Vitruvius, From Athanasius Kircher, Phonurgia Nova, 1673 (Hunt, 1992)**



**Figure1. 3 The Temple of Music, an imaginary edifice designed around music symbolism (by Robert Fludd in 1618)(Forsyth, 1985)**

Many other kinds of myths come from the analogical thinking. The following list some of them:

- Auditoriums with bell shape was designed in hope to be sonorous as a bell
- Wood is considered as the best material because many music instruments are made of it.
- Like wine, concert halls become fine and mellow with time.

In modern days such analogical hypothesis have been rejected or explained by scientific knowledge, but historically they did influence the concert hall designs, and the belief in wood material is still retained by some artists. Barron, Beranek,

etc. provided good arguments against these myths(Beranek, 2004). Despite the chaos in philosophical justification, symbolic thinking, analogical thinking and empirical observations, some auditoriums with excellent acoustics survived through trials and errors and become the important models for later concert hall designs.



**Figure1. 4 Markgräfliches Opernhaus, Bayreuth, by Giuseppe and Carlo Galli-Bibiena, 1744-1748 (Forsyth, 1985)**





**Figure1. 5 Neues Gewandhaus, Leipzig, by Martin Gropius and Heinrich Schmieden, colored woodcut engraving by E.Limmer, 1891. It was one of the most influential concert hall, used as precedents of Boston symphony hall. (Forsyth,1985)**

## **1.2 CONCERT HALL DESIGN BASED ON PRECEDENTS**

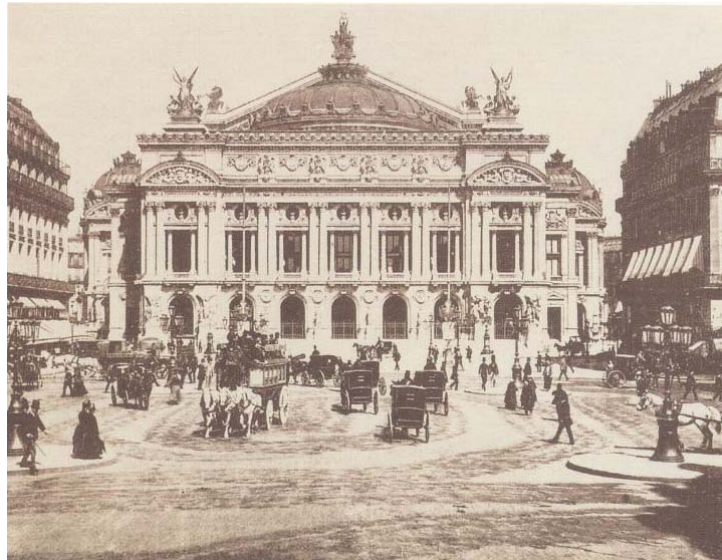
In 17<sup>th</sup> and 18<sup>th</sup> century, most of symbolic myths were abandoned due to their failures in generate sublime sound effect. Since little acoustics science was developed at this time, architects largely relied on their observations on successful precedents. Intuitive understanding became the primary source to drive architects produce innovative designs. Charles Garnier confessed in 1875 that he finally trusted luck, which was quite good considering the success of Opera Garnier: (Beranek, 2004)

*“Like the acrobat who closes his eyes and clings to the ropes of an ascending balloon..Eh bien..Je suis arrive!”*

*“It is not my fault that acoustics and I can never came to an understanding. I gave myself great pains to master this bizarre science, but after fifteen years’ labour, I found myself hardly in advance of where I stood on the first day... I had read diligently in my books, and conferred industriously with philosophers – nowhere did I find a positive rule of action to guide me; on the contrary nothing but contradictory statements.”*

It is not surprising that Garnier was not able to master the bizarre science, for architectural acoustics remains a mysterious art until Sabine's research and Rayleigh's *The Theory of Sound* at the end of 19<sup>th</sup> century.

Since few scientific explanations were available to account for the excellent sound quality of certain halls, designers could either emulate the successful precedents as close as possible, or, intuitively select certain acoustical traits considered as beneficial. Judgment and experience rather than scientific knowledge served as the basis for design decisions.

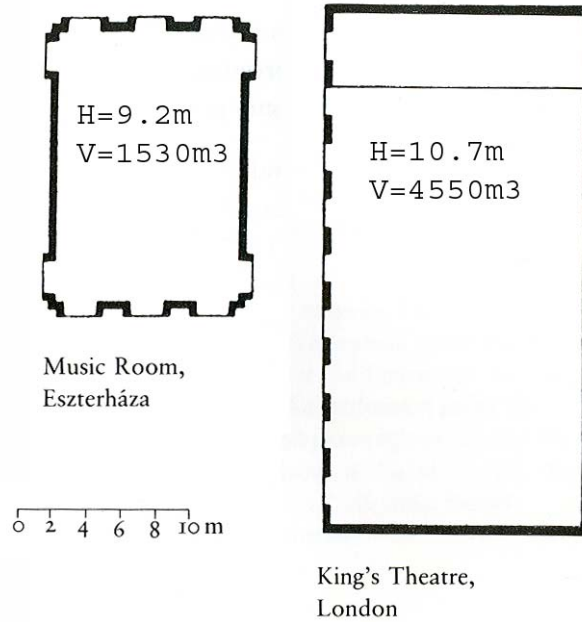


**Figure1. 6 Opera Garnier, photograph from 1895**

In this period through trials and errors the classical shoebox concert hall style was established as the most successful; and Vienna Grosser Musikvereinssaal(1870) and Amsterdam Concertgebouw(1888) were opened. They are considered as the best concert halls in the world even until present and have served as precedents for decades (Barron, 1993, Clements, 2001).



The rationale for precedent based design is beyond the superficial reason that emulating successful concert halls will guarantee good sound quality. Musicological studies show that composers were sensitive to auditorium settings and adapt their music style to them. Sabine argued that the music styles of different nations are influenced by acoustical characteristics of their auditoriums. The developments of melodic or rhythmic music were influenced by whether the local people were “housed or unhoused, dwelling in reed huts or in tents, in houses of wood or stone, in house and temples high vaulted or low roofed, of heavy furnishings or light”(Sabine, 1922). A study by Meyer shows the sensitivity of Haydn’s music style toward concert halls acoustics. For example, when Haydn writes Symphony No.61 for a small auditorium with very dry acoustics, Esterhaza hall, he wrote some very fast lines which are only recognizable in such an environment. In contrast, the Symphony No. 102 takes full advantage of reverberant environment of King’s theatre as the setting for its first performance (Barron, 1993, Forsyth, 1985, Meyer, 1978).



**Figure1. 7 The relevant scale of Eszterhaza hall and King's Theatre (Forsyth, 1985)**

More generally, Dart observed (Dart, 1954),

*But even a superficial study shows that early composers were very aware of the effect on their music of the surroundings in which it was to be performed, and that they deliberately shaped their music accordingly. Musical acoustics can be roughly divided into resonant, room and outdoor. Plainsong is resonant music; so is the harmonic style of Leonin and Perotin .. Perotin's music, in fact, is perfectly adapted to the acoustics of the highly resonant cathedral (Notre Dame Paris) for which it was written ...Gabrieli's music for brass concert is resonant, written for the Cathedral of St. Mark's; music for brass concert by Hassler or Mathew Locke is open-air music, using quite a different style from the same composers' music for stringed instrument, designed to be played indoors. Purcell distinguished in style between the music he wrote for Westminster Abbey and the music he wrote for the Chapel Royal; both styles differ from that of his theatre music, written for performance in completely dead surroundings. The forms used by Mozart and Haydn in their chamber and orchestral music are identical; but the details of style (counterpoint, ornamentation, rhythm, the layout of chords and the rate at which harmonies change) will vary according to whether they are writing room-music, concert-music or street-music.*

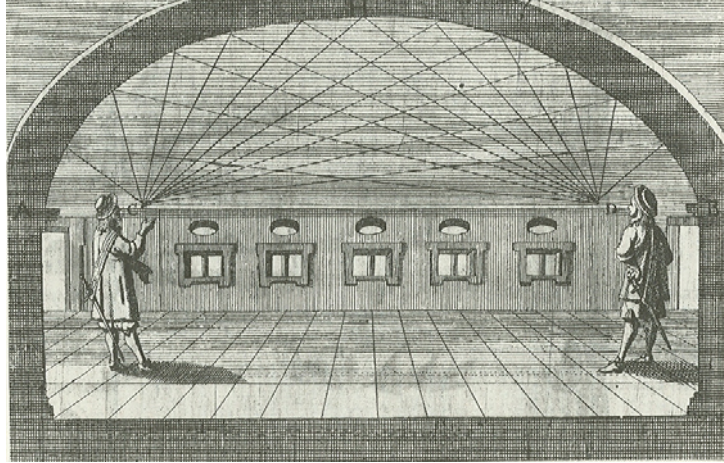
The logic for precedent based approach is that if the composers wrote their music based on the acoustic characteristics of certain music hall, that specific hall has the best architectural form to fit the function of performing this music. Following this logic, and given the fact that concert halls are designed mainly to perform a body of existing music, the research programme for designing concert

hall would have to research historical documents and identify what is the original acoustical model the composers had in mind when writing certain music. In spite of its obvious benefits in the guaranteed good sound quality, emulating historical precedents will be the end of architecture and prevent innovations (Cremer and Muller, 1982).

### **1.3 CONCERT HALL DESIGN BASED ON SCIENCE**

Scientific knowledge of sound behavior was significantly developed by mathematical analysis and experimental studies. By the time Lord Rayleigh published “Theory of Sound” in 1877, it was considered the last word on the subject for many years (Thompson, 2002). Yet the advance in acoustic knowledge fails to impact architecture design. In fact, it seems to stay divorced from application due to its complex mathematical form.

The complexity in mathematical forms is not the only thing that prevents the application of scientific principles in the domain of architecture design. Another problem for designers is that they do not know how to achieve scientific knowledge. Without a well defined goal, people may consider focal effect to be beneficial and try to use known knowledge to achieve it. For example, Patte suggest elliptical auditorium and concave form to be ideal to archive such effects, but it turns out that focal effect is not enjoyable listening experience.



**Figure1. 8 Illustration from Athanasius Kircher to show the focal effects (Hunt, 1992)**

Sabine's work made the breakthrough to link the scientific knowledge to design applications by developing the reverberation formula (Sendra, 1999).

$$RT=0.163V/A \quad (1.1)$$

Where RT reverberation time,

V room volume,

A room absorption.

The virtue of this formula is not only its simplicity, but also its clear recognition and definition of reverberation time as a design goal. As Sabine considered architectural acoustics as two domains. One is pure physical investigation of sound propagation and its interaction with enclosure, and the other is subjective perception of musical effects and its quantification. Sabine's formula is used to predict the reverberation time, while the reverberation time is used as the critical parameter influencing music appreciation and its optimum range is investigated. The establishment of Sabine's formula is considered as the starting point of architectural acoustics (Sendra, 1999). This formula also proves to be the most useful and popular tool in concert hall design.

Unfortunately, Sabine's emphasis on the influence of acoustical quality on music perception was not paid enough attention afterwards. For decades reverberation time remained the only quantified acoustical index considered by designers. It is not until the famous opening disaster of New York Philharmonic Hall in 1962 under the baton of Leonard Bernstein that people recognized the importance of psycho-acoustical study (Schroeder, 1985). By now psycho-acoustical community has been doing research to identify a set of environmental performance indexes critical for music appreciation. This index set will replace the "quirks of the orchestra", "whims of philanthropists and city officials" and other subjective perceptions with objective measurable parameters (Gilbert - Rolfe and Gehry, 2002). A brief introduction of these indexes will be discussed in Chapter 2.

#### **1.4 ARCHITECTURAL ACOUSTICS AND MODERN CONCERT HALL DESIGN**

The general research paradigm of architectural acoustics emerges through the cooperation between psycho-acoustical and engineering studies, and by now a performance based framework has been developed to facilitate the application of knowledge into concert hall design. Such a framework constitutes a set of environmental performance indexes critical for music appreciation, a set of relevant design features having impact on these indexes, and scientific models to link them together (CIB, 1982). Supported by such a framework, the consequence on performance outcomes of the design actions will be predicted and observed, and this information will help designers make more rational decision.

However, by now it is still noticed that acoustical knowledge grows faster than its application in concert hall designs. No one denies that sound behavior is predictable by scientific theories, but the role of science in concert hall design is under controversy. Although many modern great acousticians consciously facilitate the integration between science and art (Kirkegaard, 1999, Beranek, 2004, Talaske and Boner, 1987), there are still quite some acoustical practitioners counting mostly on their experience rather than scientific models in providing design suggestions. The famous claim that acoustic design should be “an art, not a science” by Theodore Schultz still have many followers in the practitioner community (Forsyth, 1985). So what is preventing the application of acoustical knowledge in design practice? What makes famous architects like Frank Gehry criticize the acoustics as “inexact science” (Gilbert - Rolfe and Gehry, 2002)?

The author argues that the maturity of applicable performance prediction models is one significant barrier. The development in wave theory makes it theoretically possible to make accurate prediction, but it demand very long computation time, and detailed information – most of time unavailable for designers. To count on simplified model introduces deviations and uncertainties depending on the assumption in the model. As will be discussed in chapter 3, there are too many different models developed from diverse perspectives and there predictions may stay quite apart. The lack of consensus on their applicability will confuse designers on which model to trust. Faced with conflicting predictions designers will have difficulty in using their for design support.

The second barrier is that there is a lack of conscious effort on how to structure the architectural features set customized for the available design information in different stage. For example, acoustical simulation software is a very useful tool for detailed design stage when detailed information is available. In earlier preliminary design phase, without detailed information designers have to do many guess work on unknown parameters in order to feed the demanding input information of software . The author argues that a good design support tool should be based on available information in specific stage. Design information should take different structures in different stage, and it calls for the research effort of architectural acoustics community to identify these stages and develop models to satisfy the needs of designers.

In general the author argues that a performance based approach will help the integration between design and knowledge. The emergence of many innovative modern concert halls and auditoriums with excellent sound quality has demonstrated how scientific knowledge can be used to improve the design and satisfy both the critical ear of audience and the aesthetics of architects.

To further facilitate science, engineering and art to meet in concert hall design, the model accuracy and the applicability to different design stages need to be improved. The author agrees with Thompson that the ultimate goal of research in architectural acoustics is to offer architects a compendium of scientific models that could simply and easily apply to their designs in various stages (Thompson, 2002).

## **1.5 RESEARCH SCOPE**

This thesis will choose reverberation time as the research subject for its uncontroversial importance as acoustical quality index. The detailed justification for this choice will be discussed in Chapter 2. This thesis will first select the preliminary design stage as the research setting. Two major concerns to choose it are the lack of design support in this stage and its significant impact on the whole design process.

The goal of this thesis is to develop a model to predict reverberation time in preliminary design stage with better accuracy in comparison with existing simplified analytical models.

Through this thesis the model applicability for preliminary design stage is of important concern. The author is aware that this model did not capture all useful and available information, hence the limitations of this model will be clearly presented in final chapter to avoid possible risk in applying this model.

## **1.6 RESEARCH METHOD**

This thesis will use both theoretical knowledge and statistical method to achieve the defined goal.

Analytical simplified model is appropriate for preliminary design stage due to the information availability in the earlier design stage. A set of design significant parameters are extracted through the study in sound physical phenomena, existing methods and the available information in conceptual design stage. A simplified model is developed to make more accurate prediction by taking use of this information.



The unavoidable problem of simplified model is the deviation caused by simplifications. This thesis approaches this problem by calibrating the model with empirical data to improve its accuracy. To ensure the rigorous coherence between the model and data, Bayesian method and a hierarchical statistical model will be applied with special attention paid to the uncertainties in the empirical data (Iversen, 1984; Harney, 2003; Bretthorst, 1998). As Bayesian method has been paid more and more attentions by pioneering research in architectural acoustics domain (Xiang, 1995; Xiang and Goggans, 2001; Xiang and Goggans, 2003), its effective application in this thesis calls for further awareness to this method in architectural acoustics research community.

This research will use published data for model calibration. Beranek's book "Concert halls and opera houses: how they sound" and other relevant publications are used as major source. Descriptions in concert hall geometry, material assignment and other acoustical treatments are available in detail. The measurement data is presented in the octave band format for use.

## **1.7 THESIS STRUCTURE**

This thesis is structured as following:

Chapter 2 discusses the justifications for selecting reverberation time as research subject. Along with the discussion the background information about reverberation time is presented.

Chapter 3 discusses the existing reverberation time prediction methods and the justification for the semi-empirical approach of this thesis.

Chapter 4 discusses a simplified model to represent the shape influence.

Chapter 5 and chapter 6 develop a simplified analytical model to account for the non-uniform material distribution and scattering effect.

Chapter 7 summarizes the model, integrate a numerical scaled evaluation method, and develops a statistical model for data calibration.

Chapter 8 discusses the Bayesian method and the corresponding software tool.

Chapter 9 elicits the uncertainties in empirical data to prepare for Bayesian calibration.

Chapter 10 calibrates the model with a few cases. This model is validated with a simple example to demonstrate its improved accuracy.

Chapter 11 summarizes thesis work, the contribution and limitation of the model. Future work is also proposed.

## **CHAPTER 2**

### **Reverberation Time**

As discussed in Chapter 1, the goal of this thesis is to contribute to acoustics design by providing a model that links design parameters to acoustical quality index(es). After careful considerations, this thesis chooses to focus on reverberation time as acoustical quality index from three aspects.

First of all, although many acoustical indexes are developed in literature, reverberation time is selected due to the consensus on its importance from researchers and practitioners. Furthermore, studies show that the influence of reverberation time on music appreciation is independent from other indexes(Ando, 1985), and thus provides justification for this thesis to select reverberation time without considering its relationships with other indexes. Sections 2.1 through 2.2 discuss the role of reverberation time against other acoustical performance indices in the context of music appreciation. Section 2.3 discusses the frequency dependency of reverberation time and the frequency range concerned in this thesis.

Secondly, since this thesis is focused on preliminary design stage, it is important to choose indexes that are possible to be predicted in this stage. If an acoustical index is significantly influenced by details like the angle of one specific acoustical panel, the decisions made in preliminary design stages will play a less important role in its final performance, and thus will not be an appropriate research subject for this thesis. Among all the acoustical indexes, reverberation time is the one least influenced by design details

like angle of certain reflection panel (Barron, 1993). Furthermore, for preliminary design stage, only global or overall assessment of the concert hall sound quality is possible or necessary. This further justifies the selection of reverberation time as it is least affected by position variability (Nakajima, 1997; Lundeby, 1999). Section 2.4 discusses the location variability magnitude of reverberation time in detail.

Finally, since this thesis will use empirical data for model calibration, the measurement accuracy is an important concern. Research has shown reverberation time measurement error to be least. Section 2.5 addresses this issue and discusses the reliability of reverberation time measurement method.

## **2.1 CONCERT HALL ACOUSTIC PERFORMANCE INDEX**

Psycho-acoustical research has recognized the underlying sound quality dimensions that are important for music appreciation. In general they fall into two categories: temporal and spatial. It is necessary to have an overview on the recognized indexes and be aware that reverberation time is an important but not the only sound quality index.

Temporal indexes characterize the audience perception on the time domain. The temporal features are closely related with the sound reflection phenomena in an enclosed space. Figure 2.1 provides an intuitive picture to understand sound propagation, and a more detailed description on sound propagation will be discussed in Chapter 3. Due to reflection of sound from enclosures, audience keeps receiving signals after the arrival of direct sound. This is completely different with outdoor condition, where sound passes by and doesn't return. In an enclosed space excited by an impulse signal, audience first hears the direct sound, and then a decaying continuation of reflected sound. The arrival sound signal is illustrated in Figure 2.2. Two basic indexes to describe this process are marked

as ITDG (Initial Time Delay Gap) and reverberation time (RT). ITDG describes the time interval between direct sound and the first reflected sound, and reverberation time describes the time interval for sound to decay 60db. The subjective perceptions associated with these two indexes are intimacy and liveliness. The longer ITDG is, the longer distance audience perceives between the sound source and himself, and thus feels less intimate. The longer the reverberation time is, the music tone is better developed and the hall is considered as more “live”, in comparison with “dry” with short reverberation time.

Two other important performance indicators,  $D_{50}$  and  $C_{80}$  are developed to describe the ratio between early and late sound energy in time domain. The rough idea is that the more sound energy arrives in the early phase, the easier to recognize it.  $D_{50}$  was proposed by Thiele (Thiele, 1953) to measure the speech clarity. It is defined as the proportion of the early sound energy arriving within 50ms after the direct sound. Later Reichardt et al (Reichardt et al, 1975) considered that 80ms is more appropriate for music appreciation and thus proposed  $C_{80}$ . Nowadays  $C_{80}$  is the mostly used clarity index in concert hall acoustics (Barron 1993).

These indexes need to be well balanced for their conflicting natures. The livelier and more intimate the hall is, the more energy arrives in the early stage, and may result in less clear sound effect (Barron 1988).

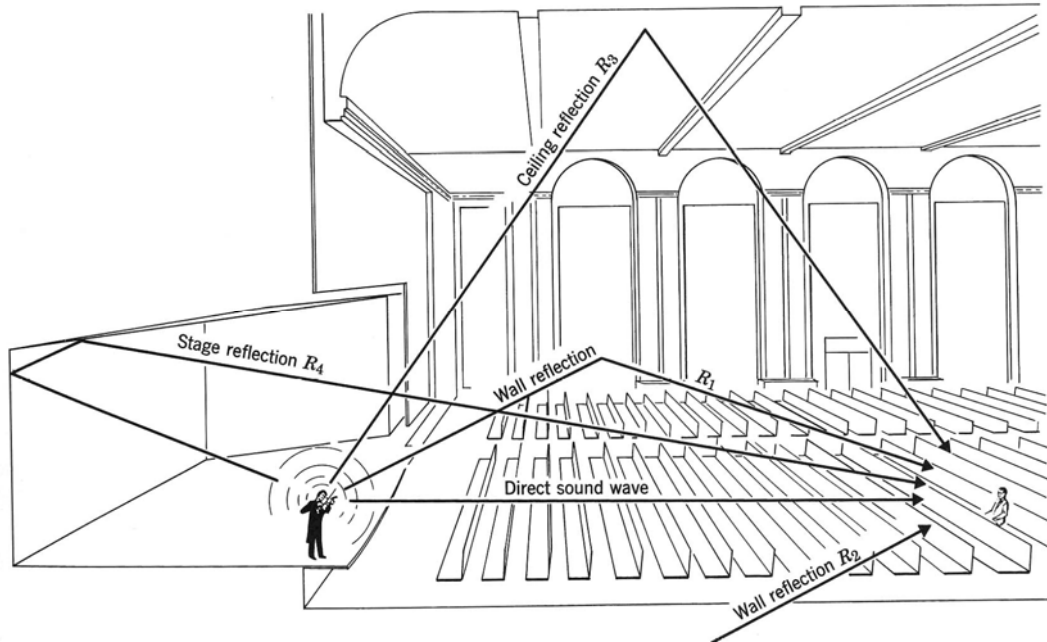


Figure 2. 1 Sound Propagation in Concert Hall (Beranek, 2004 )

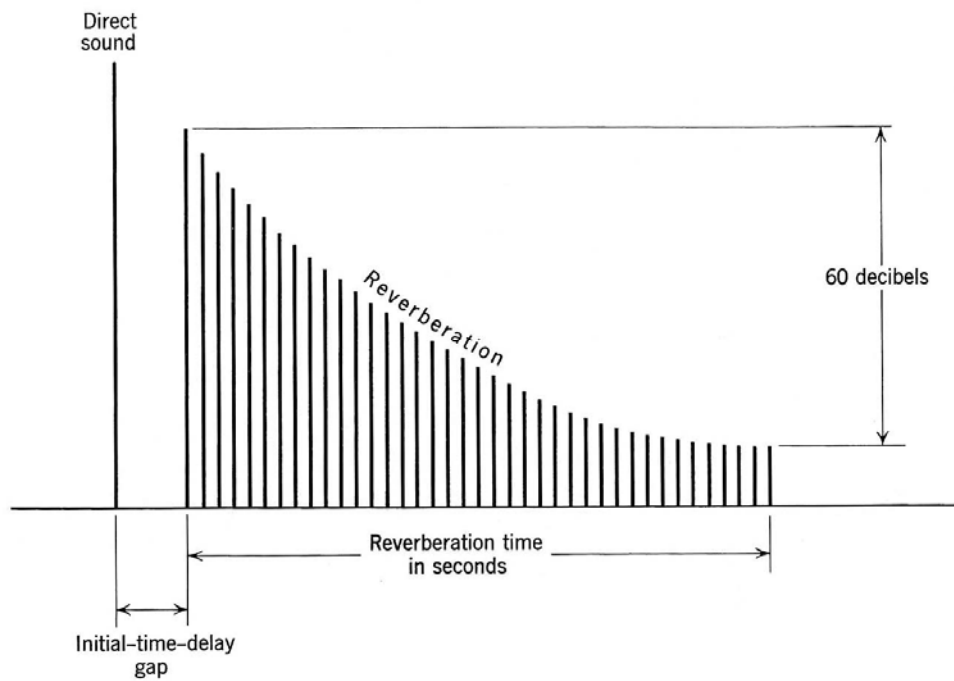


Figure 2. 2 Reverberation time and ITDG (Beranek, 2004 )

An objective sound quality index to account for spatial perception was not recognized until it was first suggested in 1967 and 1968 (Marshall 1967), although musicological studies has found that composers like Haydn had serious concern in the spatial sound quality of auditorium settings (Barron 1993). Researches show that the people prefer the sound when it reaches the two ears with phase difference. This lateral dissimilarity can be characterized by Inter-Aural Cross Correlation (*IACC*). It can be measured by comparing the difference between two signals reaching both ears. Ando's experiments show that people consensually prefer the greater lateral dissimilarity index *IACC* (Ando 1985).

Another important perception in spatial domain is called "Listener Envelopment" (LE).. LE addresses how the listener feels surrounded by the music, rather than listening to it as if through a window. A good listener envelop is that the sound comes from all direction rather than from limited directions. It is measured by Lateral Energy Fraction, as a ratio of sound energy arriving laterally over sound energy arriving from all directions ( Barron 1988; Ando and Noson 1997; Beranek 2004). The accurate definition of  $D_{50}$ ,  $C_{80}$ , *IACC* and *LE* are closely related with impulse response method (Barron, 1993) and not listed here, but their measurements can be easily performed by digital device produced by acoustical equipment manufacturers.

Spatial performance indexes are predictable from architectural geometry, acoustical material assignment and acoustical panel distribution. However, they are closely associated with the detailed features and thus not suitable for concern in conceptual design phase. For example, the angle of acoustical panel may significantly influence the lateral reflection and the resultant spatial index *IACC* and *LE*. Since this thesis focuses on

the preliminary design stage where no detailed information is available, the spatial indexes are out of consideration.

Furthermore, this thesis uses empirical data which is presented in the form of global value (one average value for the whole hall); therefore it is chosen to focus on the indexes that are of less local variability. According to the study by Pelorson et al (Pelorson et al. 1992), reverberation time has the most uniform distribution across the audience seat in comparison with all other acoustics performance indexes. Hence reverberation time is chosen as the focus on this study.

## **2.2 REVERBERATION TIME AND MUSIC APPRECIATION**

Reverberation time has been one of earliest and most important acoustical quality index that influences music appreciation and general listening experience. Its definition, measurement method, and prediction method were first introduced by Sabine. It is also the first index to link the subjective music appreciation with the physical parameter of a space.

From daily experience we know that people tend to be more on tune when humming in a reverberant space like bathroom than open space. Similarly but more critically, musicians expressed their sensitivity toward the reverberation of the performing space. To quote Issac Stern,

*“Reverberation is of great help to a violinist. As he goes from one note to another the previous note perseveres and he has the feeling that each note is surrounded by strength, When this happens, the violinist does not feel that his playing is bare or naked – there is a friendly aura surrounding each note”*

E. Power Biggs makes comments on the dependence of organ music on the long reverberation setting,



*“An organist will take all the reverberation time he is given, and then ask for a bit more, for ample reverberation is part of organ music itself. Many of Bach’s organ works are designed actually to exploit reverberation. Consider the pause that follows the ornamented proclamation that opens the famous Toccata in D minor. Obviously this is for the enjoyment of the notes as they remain suspended in the air”*

To provide an optimum value for reverberation time is the first step for acoustical design. As discussed earlier in chapter one, historically music style is influenced by the reverberation time setting for which it was written. This means that simply to respect the intentions of composers different music style requires different optimum reverberation time. Moreover, instead of studying the original intentions of the composers, psycho-acoustics focuses on the recognition of the most desirable listening environment perceived by people in a scientific manner.

As early as 1956, Kuhl performed a famous round robin investigation by recording three pieces of music in halls with different reverberation times and asking listeners to evaluate them. The listeners included musicians, acousticians, historians and relevant engineers. The results showed that for Mozart’s Jupiter symphony and Stravinsky’s “Le Sacre du Printemps” 1.5s was considered as optimal; while for Brahms’ 4<sup>th</sup> Symphony 2.1s was considered as suitable. This research confirmed the intuitive conjecture that reverberation time should be different depending on music style. Nevertheless, it can be criticized from two perspectives: 1. music professionals may simply prefer the reverberation time they used to hear thus the optimum value is not determined by human nature but their environment; 2. the influence of reverberation time may interfere with other hidden factors (Kuhl 1954; Kuttruff 1999).

Development in hearing physiology and experimental methods in the past 60 years has resulted in more scientific research in this area. Ando and his colleagues (Ando, 1985) performed important research in this area, and provided more solid evidence for

the importance of reverberation time from the physiological ear-brain mechanism perspective. They also discovered that reverberation time is the dimension in the temporal perception of left hemisphere, and its influence is orthogonal with spatial perceptions of right hemisphere. The implication of this conclusion is that music appreciation influenced by reverberation time is independent from other indexes, and therefore can be studied separately. Ando et al's research also addressed the relation between music style and reverberation time. They consider music as stochastic signal and characterize the music style with its autocorrelation function (*ACF*). Empirical functions are established for the optimum reverberation time using the *ACF* parameters (Ando 1998).

Contemporary concert halls usually need to perform different types of music requiring different music styles, thus various controlling elements like draperies and reverberation chambers are introduced in modern halls to adjust its reverberation time. To design halls with variable reverberation time is an interesting issue, but beyond the scope of this thesis. Table 2.1 lists the recommended occupied reverberation time for different purpose, and Figure 2.3 demonstrates more detailed information recommended by Bruel& Kjare (Wilson, 1989).

**Table 2.1 Recommended occupied reverberation time (s)  
(Barron 1993)**

Organ music	>2.5
Romantic Classical music	1.8-2.2
Early classical music	1.6-1.8
Opera	1.3-1.8
Chamber music	1.4-1.7
Drama theatre	0.7-1.0

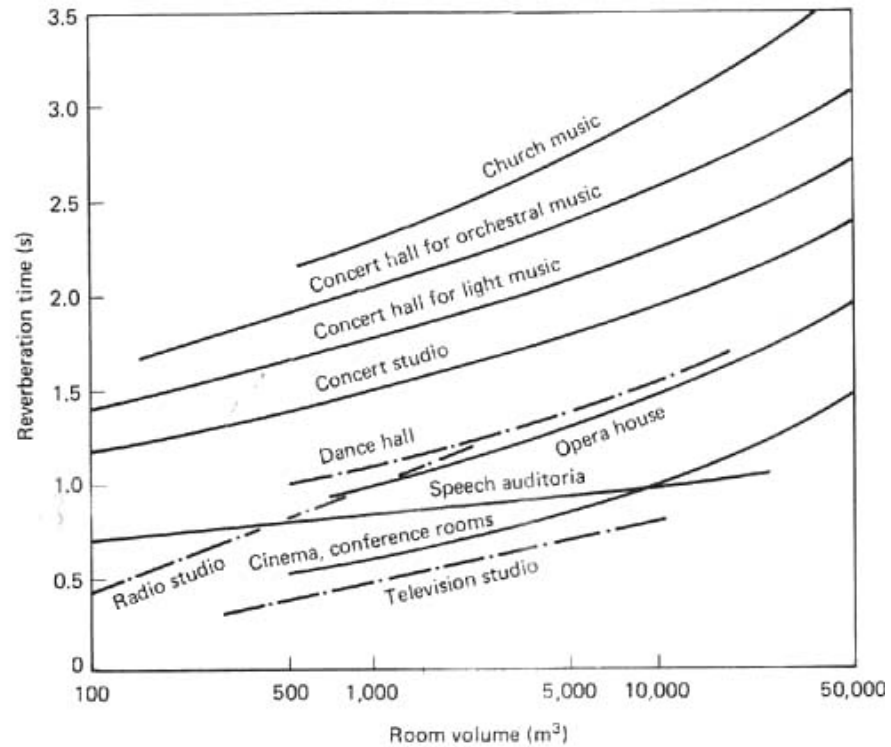
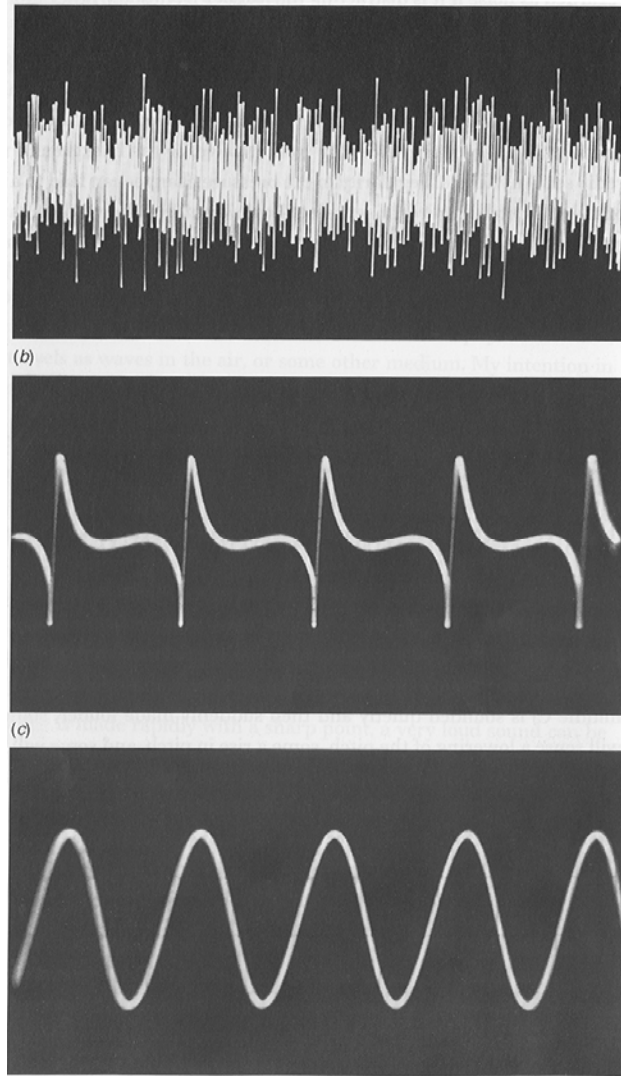


Figure 2. 3 Recommended Reverberation Time (Wilson, 1989)

## 2.3 SOUND FREQUENCY AND REVERBERATION TIME

Illustrated in Figure 2.4, general audible sounds can be divided into the following categories depending on their wave characteristics: noise, pure tone and music. Noise lacks distinct pattern; pure tone is a sinusoidal variance at a single frequency; and music tone consists of a fundamental tone and its harmonics (multiples of fundamental frequency) (Hunter 1957). Although the harmonic wave nature was not fully understood until the development of wave theory, the fact that musical harmony is associated with simple ratio (1:2:3:4:5) was discovered by ancient Greeks. As Vitruvius (Vitruvius 1960) proudly stated, “Harmonics is an obscure and difficult branch of music science, especially for those who do not know Greek.”. Later on the theory on music harmony was developed on a scientific base (Helmholtz, 1862).

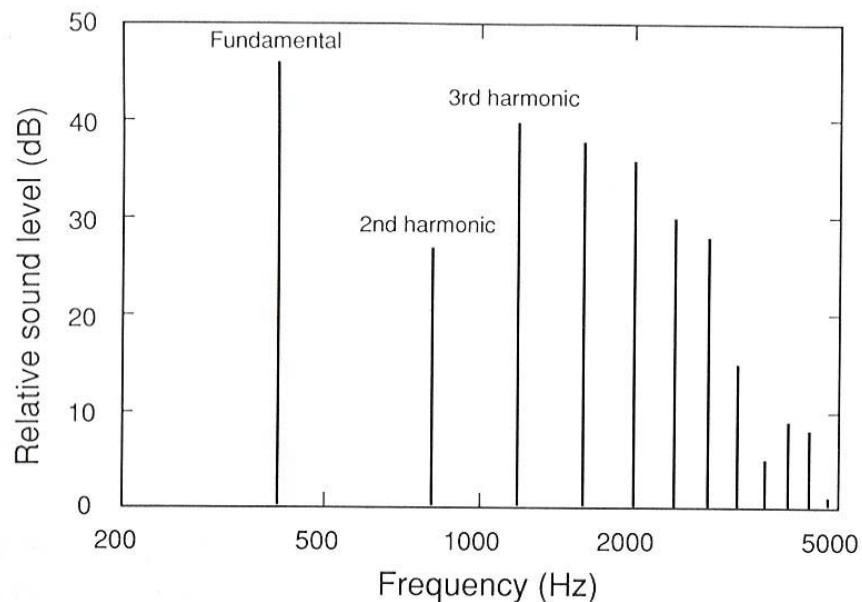


**Figure 2. 4 Sound wave forms (Taylor, 2000)**

Figure 2.5 illustrates the frequency spectrum of a music tone. The lowest frequency in a music tone is called first harmonic and determines the pitch perceived by our ear, while the relative strength of harmonics characterizes the sound quality or timbre of the instruments (Barron 1993).

Since acoustical performance indexes are frequency dependent, their values are represented as octave band format. The frequency range of music instruments is illustrated in Figure 2.6. It is shown that although human hearing range is 20-20000 Hz,

the frequency range of music instruments is generally below 5000Hz. This thesis will follow the convention and concern reverberation time at following frequencies: 125Hz, 250Hz, 500Hz, 1000Hz, 2000Hz, and 4000Hz. Besides the individual value of frequency dependent reverberation time, their relative magnitudes influence perception of “warmth” and “brilliance”. The perception of warmth is associated with stronger reverberation of low frequency sound like bass, and it is defined as the ratio between low and mid frequency reverberation time. The perception of brilliance is associated with stronger reverberation of high frequency sound produced by string and other instruments, and it is defined as the ratio between high and mid frequency reverberation time. Following Beranek’s convention, in this thesis low frequency refers to 125Hz and 250Hz, mid frequency refers to 500Hz and 1000Hz, and high frequency refers to 2000Hz and 4000Hz.



**Figure 2. 5 Spectrum of the clarinet in its middle range, fundamental frequency 415HZ  
(Barron, 1993)**

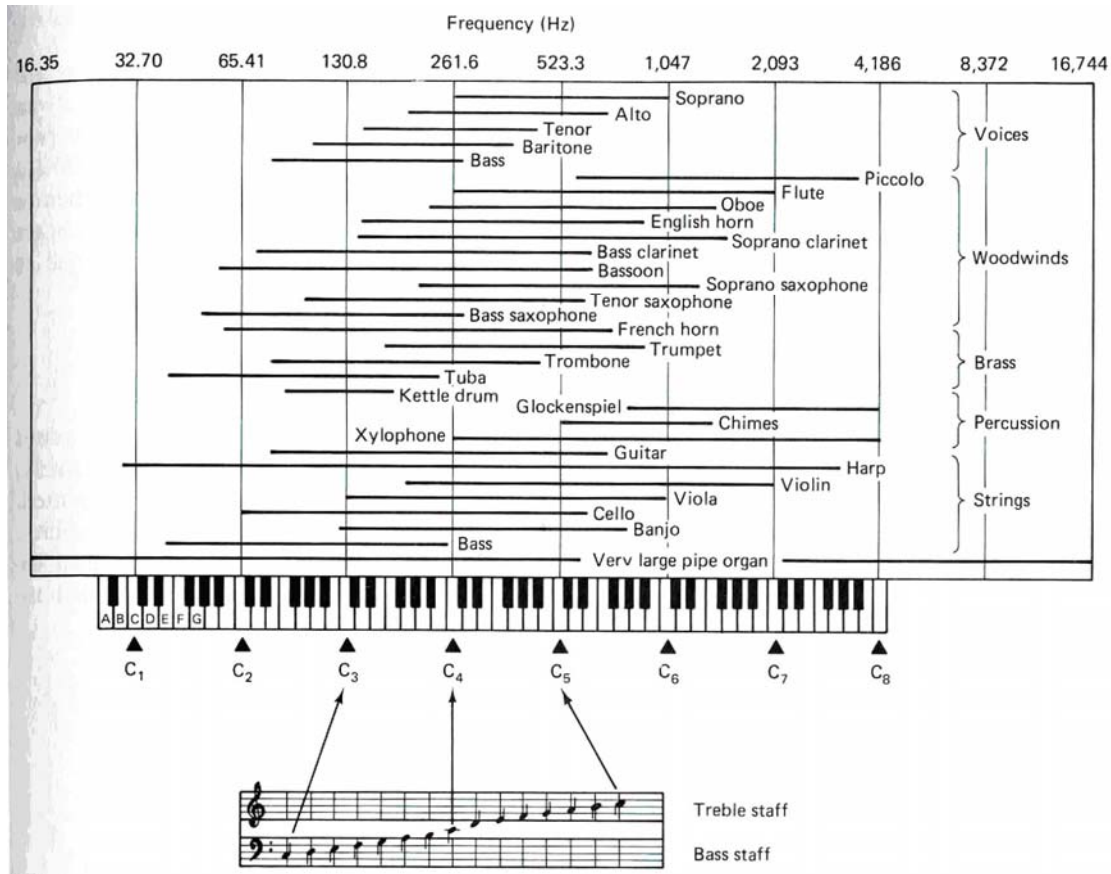


Figure 2. 6 Frequency range of music instruments (Pierce, 1981)

## 2.4 REVERBERATION TIME POSITION VARIBILITY

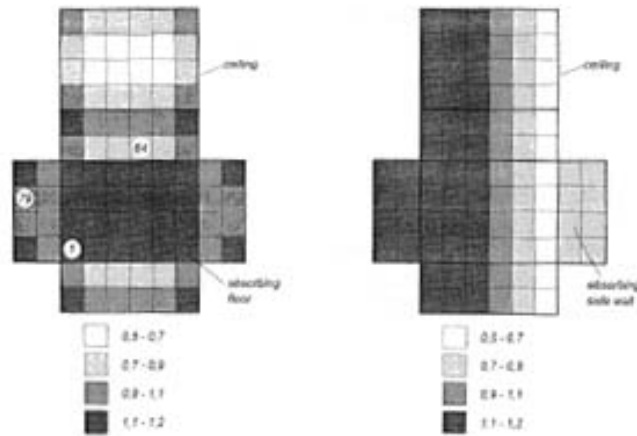
Measurements in concert hall settings have shown that reverberation time is the most uniform distribution in comparison with other indexes like IACC, IDTG and so on (Nakajima, 1997). This section will discuss the magnitude of position variability of reverberation time in detail to further justify the usage of global value to represent the performance of the whole concert hall.

### 2.4.1 Theoretical study

Two factors that influence the distribution of reverberation time are shape and distribution of absorptive materials.

If the room has a distinctive shape, e.g., cylindrical, the curved surfaces can focus sound to certain area of the enclosure and result in the variance in reverberation time (Cox and D'Antonio 2004). For long rectangular enclosure, experimental and simulation studies have shown that the longer the distance between source and receiver, the longer the reverberation time even if the absorptive materials are uniformly distributed along the enclosure. (Picaut, Simon et al. 1999; Kang 2002)

Reverberation time position variability within a concert hall subjects to the relative assignment of absorptive material. Kuttruff did computer simulation to study this problem. Typical concert halls have heavy absorption at audience and light absorption on other surfaces. Kuttruff simulates a room with 100% absorption material at audience surface. The left figure in Figure 2.7 shows that reverberation time distributed evenly all over the audience area (Kuttruff 1995). However, if the heavy absorption is moved to a side wall, then the right figure in Figure 2.7 shows that reverberation time significantly differ by position. The comparison of these two simulation results demonstrates that the distribution of absorption material distribution influence the position variability significantly. The surface with the heaviest absorptive coefficient has the most uniform reverberation time distribution. For concert halls, since the audience surface contributes the highest absorptive capacity, the reverberation time is expected to be uniform on this surface.



**Figure 2.7 Reverberation time distribution with different distribution of absorptive materials (Kuttruff, 1999 )**

### **2.4.2 Measurement data**

In most measurements different receivers are placed but only average value is reported without addressing its deviation from the individual receiving points.

Pelorson et al (Pelorson et al. 1992) explicitly addressed this problem by reporting the standard deviation of individual positions. 212 locations are taken in 11 halls and the standard deviation is shown in Table 2.2.

**Table 2.2 Position variability in 11 halls measured by Pelorson et al**

Hall	Volume(m <sup>3</sup> )	STD(s)	Range between Lowest and Highest value(s)
BST	21000	0.1	0.15
TMP	18500	0.1	0.4
TDA	9800	0.15	0.3
TCE	7000	0.1	0.4
OL	6500	0.15	0.5
DAU	5200	0.1	0.15
SOV	3600	0.1	0.4
POV	3300	0.5	2.1
LYR	3000	0.1	0.4
CMR	2400	0.2	0.8
OLM	2200	0.2	0.4



One technical document reported the acoustic performance at 4 points (left front, right front, mid-house, left rear) in Ferst Center for the Arts in Atlanta (Acentech 1998).

The following table is structured based on the supplied data in the document.

**Table 2.3 Position Variability in Ferst Center of Art, Atlanta**

	63Hz	125Hz	250Hz	500Hz	1000Hz	2000Hz	4000Hz
RT STD (s)	0.2	0.3	0.2	0.1	0.1	0.0	0.1
RT Mean (s)	2.8	2.4	1.5	1.4	1.3	1.3	1.3
RT range (max-min) (s)	0.55	0.5	0.3	0.2	0.15	0.1	0.1
RT STD as percentage of RT	8.4%	11.1%	10.6%	6.7%	4.8%	3.6%	4.6%

To further investigate the position variability, this thesis also observes results from other independent studies. From data supplied in Lundeby's study (Lundeby and Vigran 1999), it is estimated that standard deviation of reverberation time for different location is about 10% (0.15s). From data supplied in Abdou's study (Abdou 2003), it is estimated that the standard deviation measured at different location is less than 5%.

In summary, literature survey shows that the reverberation time position variability is in general around 5-10%, and it is not necessarily correlated with the size of the hall. It is to be aware that this position variability number may not be reliable enough since the measurement error is about the same scale. Therefore the study on reverberation time position variability still needs the improvement of measurement equipment and methods (Pelorson et al. 1992), and it would be reasonable to use an overall reverberation time index to represent the sound quality performance across the whole hall.

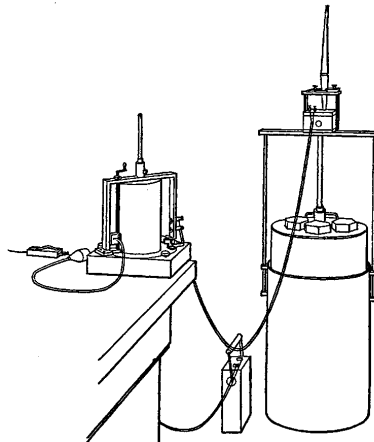
In practice, it is ideal to achieve the uniform distribution of reverberation time in the audience area, and acoustic detailing treatments such as scatters may help the achievement of diffusive listening area. Furthermore, all these measurement are performed when the hall is unoccupied. The occupied hall measurements are more

difficult for the intrusion of measurements and more demanding signal processing method (Kirkegaard, 1996; Allen, 1993). However, from the position variability perspective, when the full presence of audience increases the audience area absorption coefficient, the reverberation time distribution is expected to be more uniform. This further justifies the use of one global reverberation time index in this thesis.

## **2.5 REVEBERATION TIME MEASUREMENT**

### ***2.5.1 Measurement Principles***

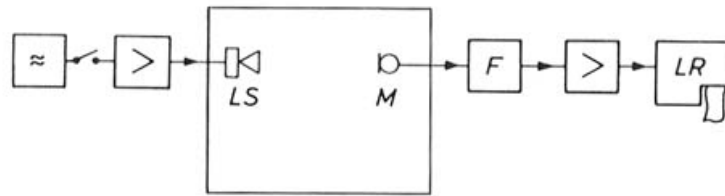
When Sabine performed experiments for reverberation time, the only equipment he used was a few organ pipes, a stop watch and his ear. A large tank of compressed air was used to sound the organ pipe mounted on top of it. By turning off the air supply and listen to the continuation of sound, Sabine measure the reverberation until it is inaudible. A chronograph on the table recorded the interval, or reverberation time (Thompson 2002).



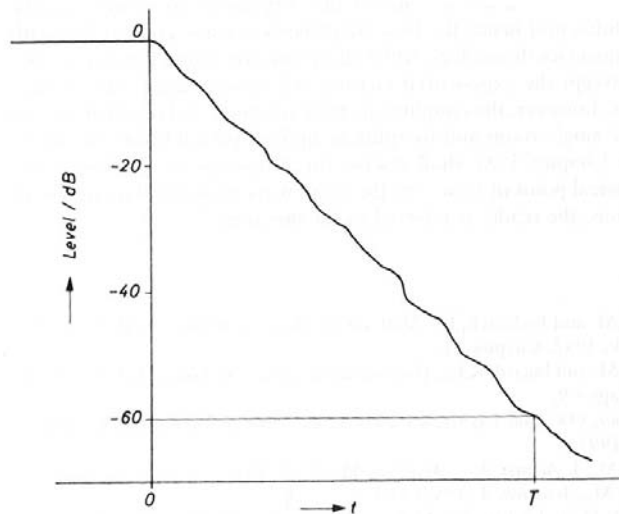
**Figure 2. 8 Equipment Sabine used to explore reverberation time (Thompson, 2002)**

The modern version of Sabine measurement method is “Interrupted Noise Method”. A loudspeaker is driven by a signal generator (white/pink noise) to excite the room to a

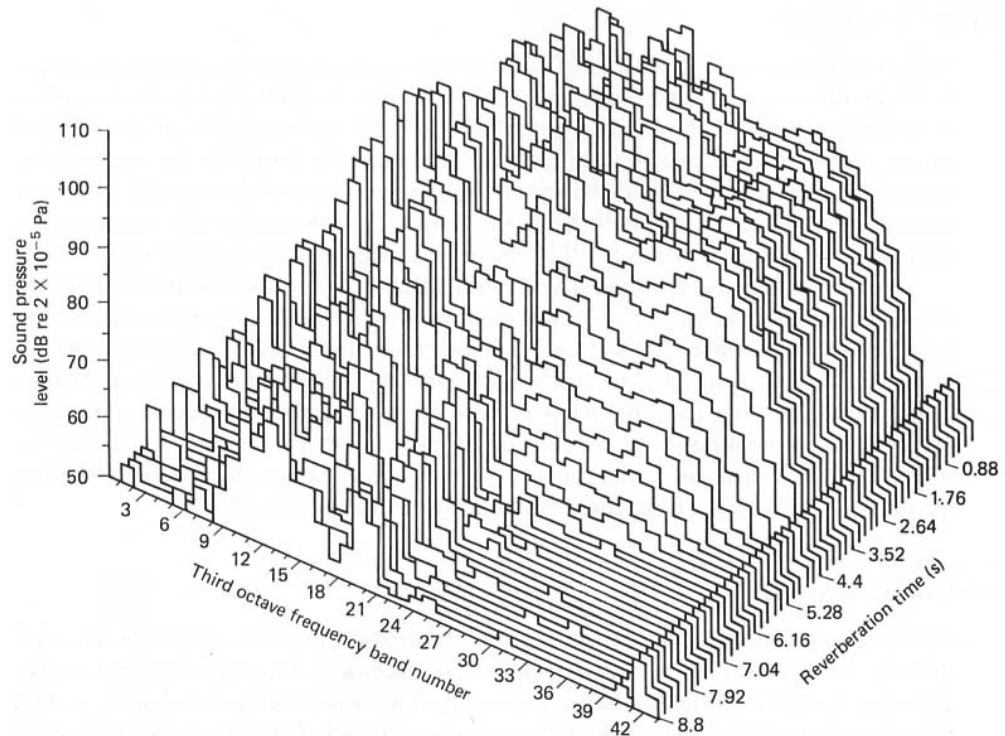
steady state. A microphone receives the signal and passes it to the amplifier and filter. The frequency dependent decaying processes are recorded and reverberation time can be computed (ISO3382). Figure 2.9 and 2.10 separately show the measurement principle and a typical decaying process. In Figure 2.10, the y axis represents Sound Pressure Level (*SPL*), which is defined as  $10\log\frac{p^2}{p_{ref}^2}$  where  $p$  is the sound pressure and  $p_{ref}$  is the reference pressure. Corresponding to the drop of 60db in *SPL* means that sound pressure drops to 1/1000 of the original value, and the sound energy decays to 1/10<sup>6</sup>. Figure 2.11 represents the sound decaying process as a three-dimensional landscape where the axes are amplitude, frequency and time.



**Figure2.9 Reverberation time measurement method (Kuttruff, 1999)**



**Figure2.10 Typical Recorded Sound decaying process (Kuttruff, 1999 )**



**Figure 2.11 Representation of Decaying process (Wilson, 1989)**

The problem with this method is the uncertainties introduced by the noise generator for its random nature (Kuttruff, 1994), therefore the decaying process will have significant variances for each individual measurements. A large number of repetitive measurements will be needed to achieve measurement accuracy.

Impulse response method was proposed by Schroeder to improve the measurement reproducibility (Schroeder, 1965). The theory foundation is that the impulse response represents almost all information of linear time invariant system, and room response driven by interrupted noise signal can be computed through convolution between the impulse and noise signal (Xiang 1995). In practice the impulse Delta signal can be approximated by pistol shots, and a more sophisticated MLS method is used to determine

the impulse response with pseudorandom signal (Schroeder, 1979, Xiang 1992, Borish & Angell 1983, Xiang and Schroeder, 2003, Chu, 1990).

Once the impulse response is acquired, Schroeder backward integration method can be used to determine the decay function. Its essence is that the ensemble average  $\langle h^2(t) \rangle$  can be estimated by the impulse response  $g(t)$  by equation (2.1) (Schroeder, 1965).

$$\langle h^2(t) \rangle = \int_t^\infty [g(x)]^2 dx = \int_0^\infty [g(x)]^2 dx - \int_0^t [g(x)]^2 dx \quad (2.1)$$

This equation implies that Schroeder method can reach the accuracy of traditional method without repeating a large number of measurements. It is reported that the accuracy of impulse response method is equivalent to the average of 10 decaying curves using traditional method (Volander and Bietz, 1994).

After the decaying function is acquired through impulse method, parameter estimation techniques will be used to infer the reverberation time. In comparison with traditional linear regression fit, advanced methods handle information containing complex uncertainties. For example, BN effect is a big issue resulted from the nature of Schroeder integration (replacement of infinity in equation (2.1) with a certain value). It leaves the problem of integration limit not satisfyingly solved (Chu, 1978). Xiang proposes a nonlinear iterative regression approach to improve the accuracy of RT estimation. This model does not require a careful selection of integration limit and precise estimation of background noise (Xiang, 1995). The second successful application is Bayesian method in inferring reverberation time, where the uncertainties are rigorously handled. These advanced parameter estimation methods help to improve the measurement accuracy (Xiang and Goggans, 2001; Xiang and Goggans, 2003; Xiang et al 2005).

### 2.5.2 Reverberation Time vs. Other indexes

Two independent research both demonstrate that the accuracy of reverberation time measurement is better than most of other acoustical quality indexes. Bork measured the acoustical index in a rectangular room to assess their measurement uncertainties. Figure 2.11 demonstrates his result (Bork 2002). Lundeby and Vigran (Lundeby and Vigran 1999) organized 7 independent teams to measure a same room on different acoustical indexes. The overall uncertainty assessment is demonstrated in Figure 2.12. Both results show that reverberation time measurement has better accuracy in comparison with most of other acoustical indexes.

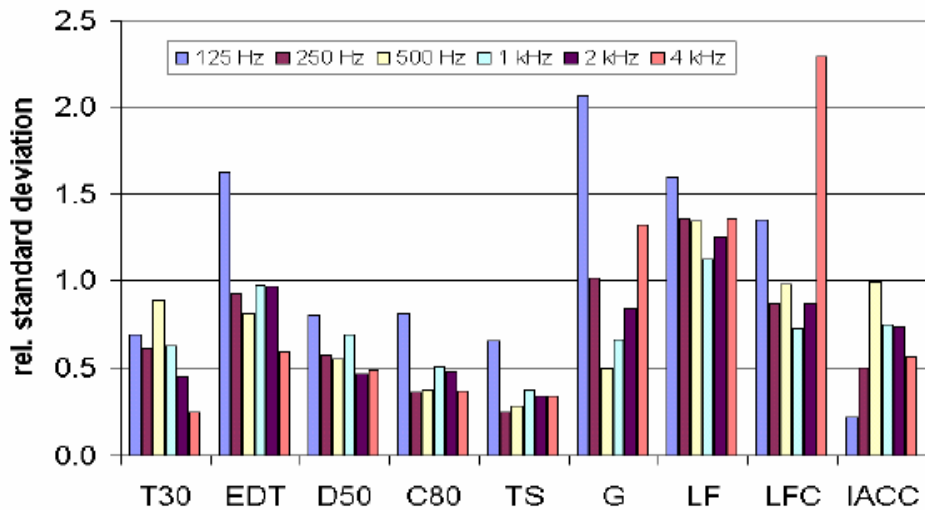


Figure 2.12 Measurement uncertainties (Bork 2002)

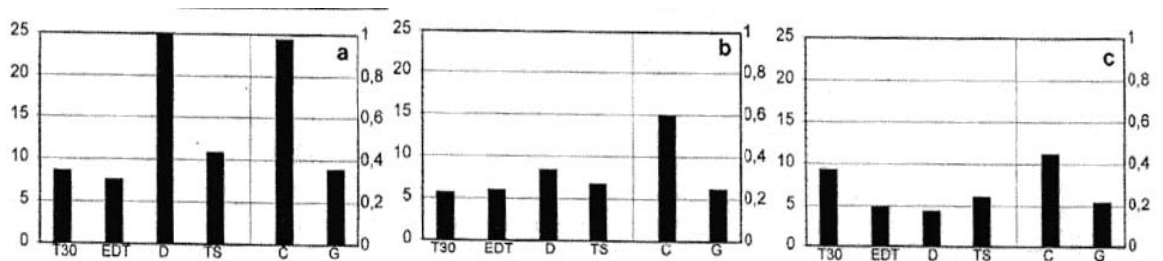


Figure 2.13 Mean relative standard deviation in % of parameters measured by seven teams from independent labs a) 125Hz, b) 1kHz, c) 4kHz (Lundeby and Vigran 1999)

## **2.6 Conclusion**

This chapter discusses the justifications for selecting reverberation time over all other acoustical quality indexes as the research subject of this thesis. Included in this discussion are relevant issues on its definition, location variability, measurement method.

The following chapters will focus on developing a model to predict reverberation time based on available design information in preliminary design stage. Chapter 3 will review the existing methods and propose the semi-empirical approach of this thesis considering its applicability in early design stages. Chapter 4 through 10 will implement such an approach by developing a simplified model calibrated using statistical methods.

## **CHAPTER 3**

### **Reverberation Time Prediction Method**

This chapter reviews existing reverberation time (RT) prediction methods as basis for proposing a different method. It is shown that existing methods to predict reverberation time are either driven by theory or by empirical data. Section 3.1 introduces the basic sound propagation mechanism and relevant concert hall engineering treatments in utilizing them. Section 3.2 introduces the scale model method to predict reverberation time. Section 3.2 to 3.7 review methods driven by theory, while section 3.8 discusses the data driven approach. This thesis argues that the most appropriate approach for reverberation time prediction in preliminary design stage is semi-empirical by developing a model combining theoretical knowledge with empirical data.

#### **3.1 SOUND PROPAGATION**

This section will introduce the basic sound propagation phenomena from the wave theory viewpoint, as the wave nature of sound is essential to fully understand its propagation. In an enclosed space like concert hall, four phenomena are associated with sound propagation process: reflection, absorption, diffraction/scattering.

##### ***3.1.1 Reflection***

Reflection is the most intuitive and earliest recognized phenomenon. In fact, directional arrows were used to model sound paths as early as 17<sup>th</sup> century by Athanasius Kircher. Figure 3.1 shows an illustration from his book “Phonuigia Nova” to explain that reflection is the reason for the speech possibility between two people who can’t see each other (Forsyth 1985).



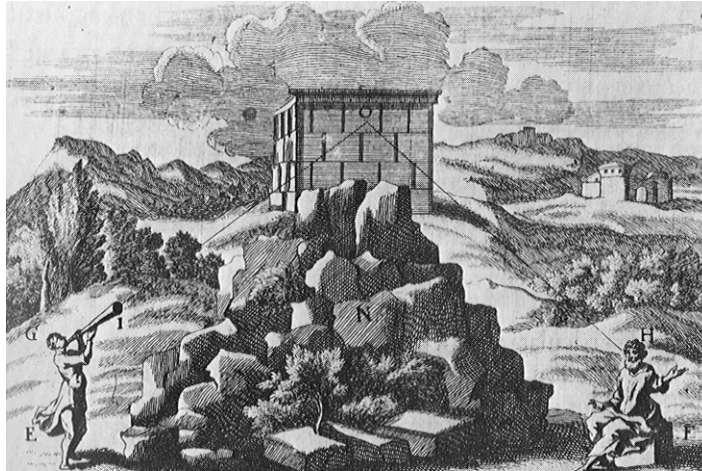


Figure3. 1 Illustration from Athanasius Kircher's Phonurgia Nova

### 3.1.2 Absorption

In room acoustics, absorption describes the energy loss when sound hits certain surface. This concept was developed after Sabine's research work (Sabine, 1922) and acoustical absorption material was quickly produced.

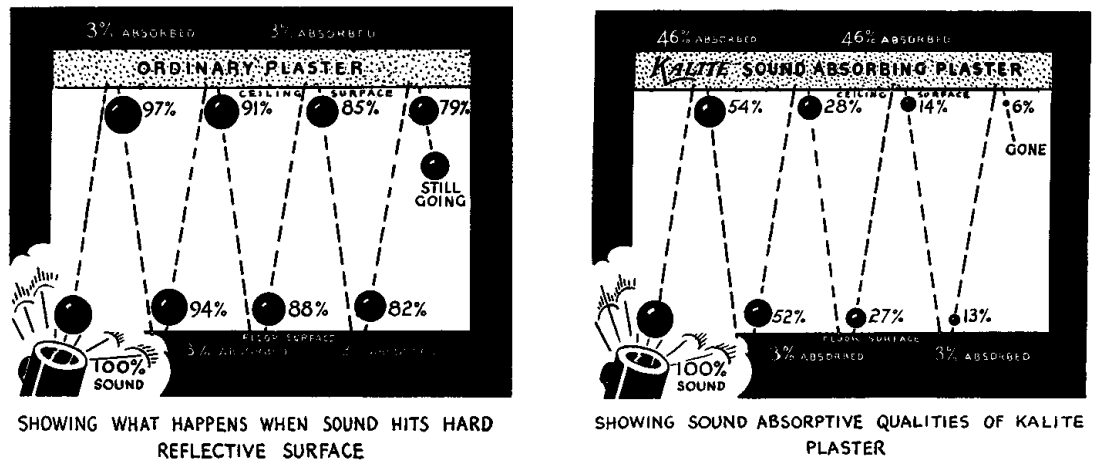
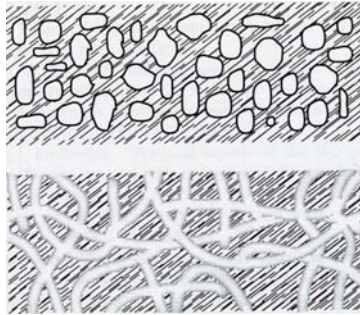


Figure 3. 2 An early absorption material commercial in 1923(Thompson, 2002)

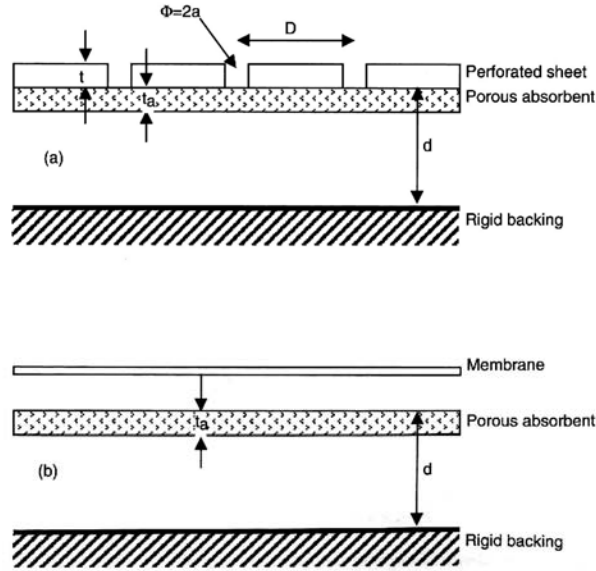
Nowadays two absorption mechanisms are mostly used in concert hall designs: dissipation and resonance. Porous materials absorb sound by viscous and thermal dissipation: viscous losses result from friction in movement of air particles in pores, while the thermal losses are due to heat conduction between air and fiber. To have

effective viscous dissipation, open pore structure of material is required. To have effective thermal dissipation, the sound needs to be at sufficient low frequency to guarantee enough time for heat exchange. Therefore, high frequency absorption is usually dominated by viscous dissipation, while for low frequency sounds thermal dissipation contributes the significant portion of sound absorption. Numerous studies have been performed to study the influence of porosity and other physical parameters on the absorptive capacity of materials.



**Figure 3. 3 Closed and Open pore structure (Cox and D'Antonia, 2004)**

Absorption based on resonance works differently by being separate objects arranged either on the wall or on free space. Two common devices are Helmholtz resonator and membrane absorber. The following figure demonstrates the typical construction for these two absorber types. They are generally designed to absorb sound of certain frequency bands.



**Figure 3. 4 Typical constructions for Helmholtz absorber and membrane absorber (Cox and D’Antonia, 2004)**

In addition, the absorptive capability of material depends on not only the material itself, but also the boundary condition, surrounding media, and incidental sound wave. The physical structure and descriptions of material determines the acoustical impedance and many models are developed in engineering field. Based on acoustical impedance, incidental angle of sound and other environmental properties, the absorptive coefficient of a material can be computed. For example, in the medium with density  $\rho$  and specific heat capacity of  $c$ , when a plane wave strikes a uniform wall of infinite extent with acoustic impedance  $Z$  at an incidence angle  $\theta$ , the absorptive coefficient  $\alpha$  can be computed as (3.1):

$$\alpha = \frac{4 \operatorname{Re}\left(\frac{Z}{\rho c}\right) \cos \theta}{\left(\left|\frac{Z}{\rho c}\right| \cos \theta\right)^2 + 2 \operatorname{Re}\left(\frac{Z}{\rho c}\right) \cos \theta + 1} \quad (3.1)$$

In room acoustics the most commonly used property is the Sabine absorptive coefficient, which is listed in most handbooks for commonly used materials. It is computed with equation 3.2 by the reverberation time measured in a reverberation room of volume  $V$  and surface area  $S$  before and after the material is placed.

$$\alpha = 0.16V \frac{1/T_{60(s)} - 1/T_{60(o)}}{S} \quad (3.2)$$

$T_{60(s)}$  reverberation time before the material is placed,

$T_{60(o)}$  reverberation time after the material is placed.

### ***3.1.3 Diffraction and Scattering Effect***

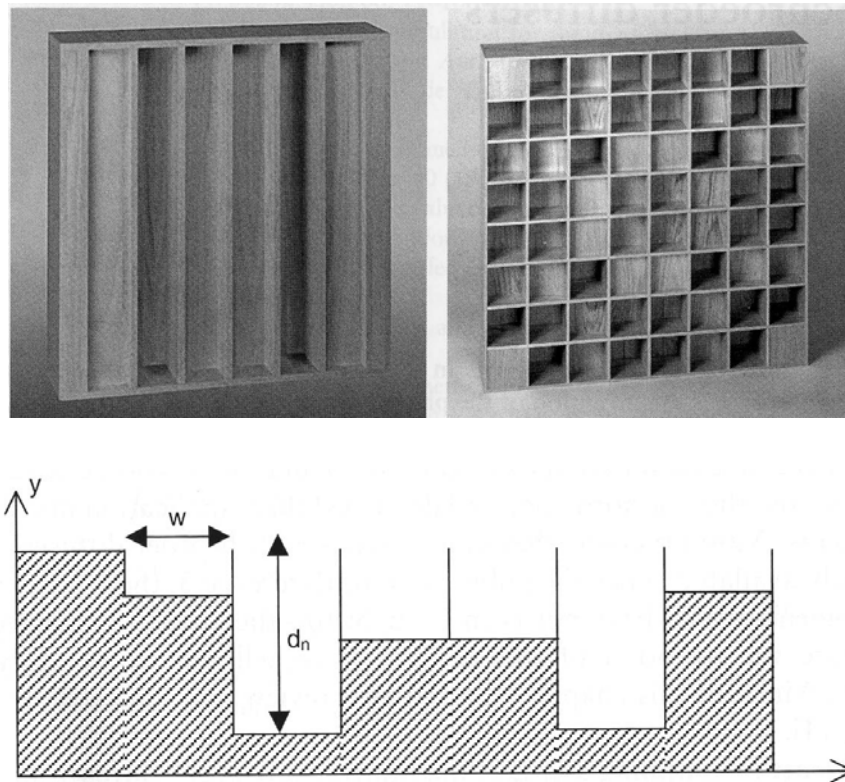
Diffraction is closely associated with the wave nature of sound. When sound encounters obstacles of small size in relation with its wavelength, instead of being reflected, it will bypass the obstacle and recombine as if there is no obstacle (Barron 1993). Diffraction also occurs when the acoustic impedance is not uniform over a smooth surface.

When hitting a surface with geometrical irregularity significant for wavelength of the sound, the diffracted wave travels in all direction and results in scattering effect. In room acoustics this scattering effect is important for music appreciation because it enhances ‘Listener Envelopment’ which indicates that sound is coming from every direction.

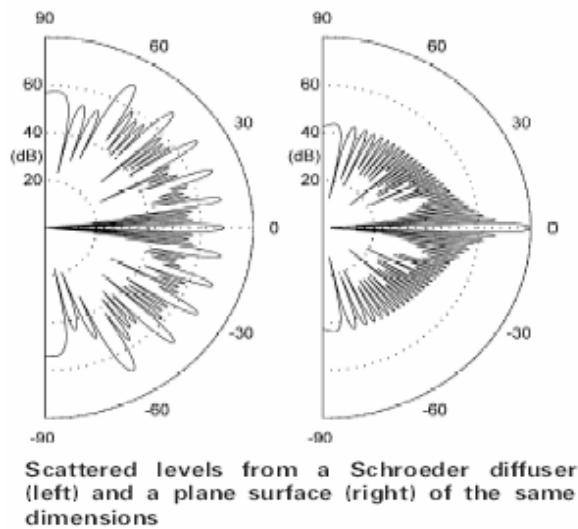
It is very common for acousticians to desire cylinders, pyramids and triangles for scattering effect, and the most popular commercial products for this purpose are Schroeder diffusers. Figure 3.5 is an example of a single plan Schroeder diffuser. It

consists of a series of wells of the same width and different depth, determined by a mathematical sequence from number theory. The scattered level from such a diffuser is also demonstrated in Figure 3.6 (Cox and D'Antonio, 2004).

It has been observed that scattering effect also has a significant influence on reverberation time prediction, and newly developed acoustical simulation software are addressing this problem by integrating scattering coefficient as one important predicting parameter and developing corresponding algorithms to simulate its effect.



**Figure 3.5 Illustration of a single panel Schroeder Diffuser (Cox and D'Antonio, 2004)**



**Figure3. 6 Scattering Effect Illustration (Cox and D'Antonia, 2004)**

### **3.2 SCALE MODEL**

Scale model has been used since 1930s to help study the sound effect by manipulate the acoustical elements in the model and observe their impacts on the acoustical quality (Barron, 1983).

By the scale model principle it is determined that the sound frequency applied in the model need to be determined by the sound speed in the media and the scale proportion. Suppose the model is filled with air, the frequency needed for the measurement will be determined by the model scale. If the concerned frequency in real room is 125Hz-4000Hz and the scale is 10:1, then the frequency applied to the scale model will be 1250-40000Hz. The demand for the high frequency transducer and signal source limits the model scale (Kuttruff, 1994). The scale factor has changed over time. Early models use scales 1:8 or 1:10. Research shows that 1:50 scale was feasible for objective measurement up to 1000Hz octave. Recent models have used intermediate scale of 1:20 or 1:25 (Barron, 1979; Barron, 1997).

Another effect to be concerned in the scale model measurement is the compensation on the air absorption as it increases significantly with frequency.

The scale model is the most direct and effective way to measure the reverberation time and test out acoustical treatments influence. It naturally take into to account the effect of scattering, diffraction and curve surfaces etc, and has become a well established technique popularly used by acousticians in practice (Sato et al, 1996; Marshall and Kirkegaard, 1993; Barron, 1979; Barron, 1997). Xiang and Blauert did research on dummy head and binaural evaluation of acoustic scale models (Xiang and Blauert, 1991; Xiang and Blauert, 1993). The difficulty for using this technique is the time cost and the reproduction of absorbing material and other treatment features.

Due to the limited resources, this thesis did not use the method for research.



**Figure 3.7 Scale Model for Atlanta Symphony Hall (Source: Kirkegaard Associates)**

### 3.3 WAVE THEORY AND ROOM MODES

This section discusses the understanding reverberation time from the viewpoint of wave theory. It is not very intuitive for it is related with the complexity and numerical method in wave equation. It will be shown that for low frequency sound the room mode should be considered and Schroeder provides a equation to suggest such a threshold. In non technical language, when the frequency of concern is lower than this threshold, the sound field must be investigated in considering the wave nature and is not appropriate to be reduced to geometrical acoustics.

Room resonance and modes are important concepts to understand reverberation in terms of wave theory. When a room is excited by a pure tone, standing waves at certain frequencies will be excited. These frequencies are the resonant frequency corresponding to room modes, and can be computed based on the eigenvalues of the wave equation:

$$\Delta p + k^2 p = 0 \tag{3.3}$$

where p is pressure and k is wave number

For rooms with simple geometry analytical equations are provided to compute these values. Whatever the source of excitation is, it will cause vibrations of certain frequencies, and the persistence of these resonant vibrations is considered as reverberation. As per sound energy behavior, the energy decaying process of each standing wave corresponding to excited frequency follows the exponential law, and the process of decay of sound energy in the enclosure is the superposition of the decay of all waves. Reverberation time characterizes the decaying speed of such a process (Kuttruff, 1999; Pierce, 1981; Hunter, 1957; Knudsen, 1932; Beyer, 1999).



The eigenvalues of a specific shape constitute the intrinsic nature of the shape and are the basis to solve the wave equations in an enclosure with certain boundary conditions and input signal description. However, it is difficult to derive analytical solutions for general shapes. For special shapes like rectangles, numerical techniques can be performed to derive a solution once boundary conditions are set. Finite Element Method (FEM), Boundary Element Method (BEM), and finite difference time domain (FDTD) are examples of numerical methods used to simulate the solution for wave equations. BEM is superior to FEM in the sense that the matrix is denser and smaller by considering the boundary characteristics. In FDTD the derivative in wave equations is replaced by corresponding finite differences, and thus it is easier to produce impulse responses than frequency domain responses. In general, although it is reliable especially in studying low frequency sound behavior, its demanding computation time and intrinsic complexity prevent practical engineering applications (Kleiner, Dalenback et al. 1993; Otsuru and Tomiku 1999; Savioja 1999)

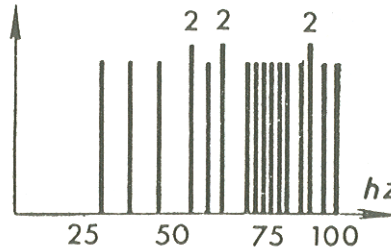
Practically, when the room is of small size, the excited frequencies may separate from each other on the spectrum diagram, especially for the low frequency area. At one location a listener may experience both enhanced and suppressed modes depending on different frequency, and when he moves he may experience a significant difference in sound loudness level. It is desirable to avoid this effect in critical listening rooms. For example, the excited frequency of a cubic room  $f_{res}$  can be derived as following by using variable separation method:

$$f_{res} = \frac{c}{2} \left[ \left( \frac{m}{L} \right)^2 + \left( \frac{n}{W} \right)^2 + \left( \frac{p}{H} \right)^2 \right]^{\frac{1}{2}} \quad (3.4)$$

Where L,W,H are length, width and height

m, n, p are integers

For example, a room of 6\*4\*3m will have the frequency spectrum shown in figure 3.8 (Mankovsky, 1971 )



**Figure 3.8 Excited frequency spectrum of a room (Mankovsky, 1971)**

The gap in the low frequency area will cause unpleasant listening experience. To define what is considered as “dense” enough, Schroeder provides a critical value by requiring that on average three eigen-frequencies fall into one resonance half-width. Equation 3.5 shows the derived Schroeder frequency after simplification.

$$f = 2000 \sqrt{\frac{T}{V}} \quad (3.5)$$

For large concert halls this critical value usually ranges in 20-30Hz. Thus the effect caused by room modes can be safely ignored unless under special conditions. This justifies the application of geometrical acoustics for concert hall reverberation time prediction.

### **3.4 GEOMETRICAL ROOM ACOUSTICS: SIMULATION SOFTWARE**

As discussed in previous section, since it is difficult to handle practical problems with wave theory due to its complexity, geometrical room acoustics was developed to simplify the acoustics discipline for practical applications. The essential assumption is to

replace the wave concept with the sound ray concept. This simplification compromises the scientific rigor, but its development and application over the last fifty years has demonstrated that it can be used for many room acoustics problems without compromising the engineering accuracy. When applying geometrical acoustics, it is important to be aware that the phenomena driven by wave nature, such as diffraction and refraction, will not be represented or handled. Other phenomena like absorption or scattering are simplified such that users only need to consider absorption and scattering coefficients rather than the underlying complicated wave mechanism. Handbooks supply data for these coefficients and significantly simplify the phenomena. However, cautions must be taken to apply these values, for these coefficients are not determined by essential nature of the material, but by interactions between the material boundary conditions and incidental waves. Later sections will further address these problems.

When sound is considered as a set of rays from the source that lose energy and change directions when hitting surfaces, tracking down each ray in time and adding those together constitutes the general energy decaying process. Certainly computation more than man-power is required to handle this problem, thus this technique was not implemented until Schroeder and his co-workers introduced computer simulation in acoustics in 1960<sup>th</sup>. Later Krokstad et al (Krokstad, Strom et al. 1968; Kuttruff 1999) further developed a simulation method for concert hall acoustics.

Three major methods in sound ray-based simulation are ray-tracing, image-sourcing and hybrid method. The distinction between ray-tracing and image sourcing methods is the way the reflection paths are calculated. To model an ideal impulse response all the possible sound reflection paths should be identified. The image source method finds all

the paths, but only a set of early reflections are computed due to the computational requirements. Thus the order of reflections depends on the available computation capacity. On the other hand, the ray tracing method applies Monte-Carlo technique to sample these reflection paths and gives a statistical result. In comparison with the full paths but lower reflection orders in image sources method, this technique attains higher order reflections but with sampled paths (Savioja 1999). Due to accuracy of image source method and the fast speed of ray tracing method, a hybrid algorithm was developed by who? to use image source method for low order reflections and ray tracing method for higher order (Rindel 2000).

Nowadays many commercial and academic software are available with faster computation speed and better visual interface. The latest Round Robin research in 2002 shows that the reliability of room simulation software has improved significantly over the past 10 years and some have been shown to have quite a good match with measurement data of a simple auditorium (Bork 2002). It has also been reported that the quality of software can vary quite significantly, and some software even do not reflect the various air absorptions at different frequencies. ODEON, CATT, CARA, RAYNOISE, AURORA, RAMSETE are popularly used software, and among them ODEON has very good reputation and wide application in academic research. This thesis has hence chosen ODEON as a research tool.

Computer simulation has both advantage and disadvantage. The advantage is that it can demonstrate the visual sound propagation process and auralized sound signals. The disadvantage is that it does not disclose the explicit relation between design parameters and acoustical quality prediction. Thus, designers can only reach their design goal by

changing the settings by trial and error, and testing the simulation results without guidance. This thesis will also use ODEON as a tool to disclose and verify the parameter-performance relations in acoustic simulations.

### 3.5 GEOMETRICAL ROOM ACOUSTICS: SABINE'S EQUATION

Sabine developed the first simple equation to predict reverberation time known as Sabine's equation. Equation (3.6) show the reverberation time  $T_{60}$  to be predicted by the room volume  $V$  and total absorption  $A$ .

$$T_{60} = 0.163 \frac{V}{A} \quad (3.6)$$

This equation was empirically derived, and its theoretical derivation was firstly supplied by William Franklin. The development of Sabine equation was the starting point for architectural acoustics as a scientific discipline.

For a room of volume  $V$  and absorption capability  $A$  with air specific heat capacity  $c$ , the derivation of Sabine's equation (Sabine 1922) in steady state given by equation (3.7) through (3.10). Given the diffusive sound field assumption, the sound density  $I$  is uniform everywhere and does not depend on the direction.

$$w = \frac{4\pi I}{c} \quad (3.7)$$

$$B = \pi I = \frac{c}{4} w$$

Suppose a sound source feeds the acoustical power  $P(t)$  into the room.

$$P(t) = V \frac{dw}{dt} + B\alpha w = V \frac{dw}{dt} + \frac{cA}{4} w \quad (3.8)$$

If  $P(t)=0$  for  $t>0$ , the differential equation yields the following solution:

$$w(t) = w_0 e^{-2\delta t} \quad \text{with the damping constant} \quad \delta = \frac{cA}{8V} \quad (3.9)$$

$$\text{Thus } T_{60} = 0.163 \frac{V}{A} \quad (3.10)$$

The assumption is that the room is in steady state conditions during sound decay process. However, the reality is that if the absorption coefficient equals to 1, there is no reverberation at all. This extreme situation implies that the bigger the absorption coefficient is, the more deviation the actual sound field has from the steady state sound field. Joyce shows that this method is exactly accurate if the enclosure is mixing and absorption is weak and uniformly distributed (Joyce 1975).

### 3.6 GEOMETRICAL ROOM ACOUSTICS: MODELS WITH MODIFICATIONS

There are several methods to derive the reverberation time formula under the assumption of diffused sound field taking into account the non-uniform distribution of absorptive material,.

If we look at the sound field as being composed of a very large number of sound particles, these sound particles move in straight line, hit the surface and lose energy because the surface absorption.

If a sound particle is observed over long time interval  $t$ , the total length it moves will be  $ct$ . If this particle hits the surface  $N$  times, the average free length  $\bar{l}$  between two hits is

$$\bar{l} = \frac{ct}{N} = \frac{c}{n} \quad (3.11)$$

It is proved that for arbitrary shape the mean free path of any sound particle is  $4\frac{V}{S}$  given the diffused sound field or diffused surfaces. (Kosten 1960; Kuttruff 1999)

Suppose there are surface  $S_1$  and  $S_2$  with absorption coefficient  $\alpha_1$  and  $\alpha_2$ . If the sound particle hit the surfaces  $N$  times, different formulas are developed according to the estimation of hit of surface  $S_1$  and  $S_2$  separately. Various approach in estimating the expected collision results in different computation methods.

### 3.6.1 Eyring's method

In Eyring's method, the probability of hitting surface  $S_1$  is estimated as

$$P_N(N_1) = \binom{N}{N_1} \left(\frac{S_1}{S}\right)^{N_1} \left(\frac{S_2}{S}\right)^{N-N_1} \quad (3.12)$$

With initial energy  $E_0$ , after  $N_1$  collisions with  $S_1$  and  $N_2=N-N_1$  collisions with  $S_2$ , a sound particle has the remaining energy

$$E_N(N_1) = E_0(1-\alpha_1)^{N_1}(1-\alpha_2)^{N-N_1} \quad (3.13)$$

Then the expected value of this expression is

$$\langle E_N \rangle = \sum_{N_1=0}^N E_N(N_1)P_N(N_1) = E_0 \left[ \frac{S_1}{S}(1-\alpha_1) + \frac{S_2}{S}(1-\alpha_2) \right]^N = E_0(1-\bar{\alpha})^N \quad (3.14)$$

Replace the total number of  $N$  with the mean value  $\bar{nt}$  where  $n = \frac{cS}{4V}$  and we have

$$E(t) = E_0 \exp\left(\frac{cS}{4V} t \ln(1-\bar{\alpha})\right) \quad (3.15)$$

By this and take into account the air attenuation we have

$$T_{60} = 0.163 \frac{V}{4mV + S\alpha_{EY}}, \alpha_{EY} = -\ln(1 - \bar{\alpha}) \quad (\text{Eyring 1930}) \quad (3.16)$$

### 3.6.2 Kuttruff's modification

Kuttruff introduced two important modifications to Eyring's equation: shape modification and material assignment modification. (Kuttruff 1970; Kuttruff 1971; Kuttruff 1995; Kuttruff 1999)

#### (1) Shape modification

First of all, in Eyring's method,  $l$ , is replaced by the mean free path, which is a significant simplification because of the non-negligible all moments of statistical distribution. Unless all paths have equal length, this simplification is not rigorous. Kuttruff extended it into the second moment, i.e., variance of free length distribution. (Joyce 1975; Benedetto and Spagnolo 1984). Equation 3.17 is derived by Kuttruff to address the shape influence:

$$\alpha_{\text{smod}} = -\ln(1 - \bar{\alpha}) \left[ 1 + \frac{\gamma^2}{2} \ln(1 - \bar{\alpha}) \right] \quad (3.17)$$

$$\gamma^2 = \frac{\bar{l}^2 - \bar{l}^2}{\bar{l}^2}$$

It is pointed out that the specularly and diffusively reflective surfaces yield essentially similar results, so  $\gamma^2$  is only related with the shape and this method can be considered as shape factor. Kuttruff used Monte-Carlo simulation to compute  $\gamma^2$ . The improved method to compute  $\gamma^2$  will be discussed in next chapter.



(2) Material assignment modification

The diffused sound field is a very stringent assumption that can hardly be approximated by reality. Kuttruff introduced a modification based on a looser condition of diffused sound surface. (Kuttruff 1995; Kuttruff 1999)

The idea is to consider the irradiation strength proportion among the enclosing surfaces. The sound decaying process is reasonably assumed to be exponential, and the equivalent sound absorptive coefficient can be derived as the following:

$$\alpha_{m\text{mod}} = \ln\left(\frac{\iint BdS}{\iint \rho BdS}\right) \quad (3.18)$$

It is reasonable to assume the following

$$B_n \sim \sum_1^N \rho_i S_i - \rho_n S_n \quad (3.19)$$

Insert it into the previous equation and we will have

$$\alpha_{m\text{mod}} = \ln\left(\frac{1}{\rho}\right) + \ln\left(1 + \frac{\sum \rho_n (\rho_n - \rho) S_n^2}{\rho^2 S^2 - \sum \rho_n^2 S_n^2}\right) \quad (3.20)$$

This modification can be extended to other method easily.

### 3.6.3 Millington's method

Instead of probability distribution of  $N_i$ , Millington considers that the particle will hit the wall portion  $S_i$  by the exact number of  $NS_i/S_{total}$ . (Millington 1932).

Therefore the energy over time will be

$$E(t) = E_0 \prod_{i=1}^M (1 - \alpha_i)^{NS_i/S_{total}} = E_0 \exp\left(\frac{cS}{4V} t \sum_{i=1}^M \frac{S_i}{S} \ln(1 - \alpha_i)\right) \quad (3.21)$$

### 3.6.4 Zhang's method

It is reasonably argued by Zhang that Eyring equation (3.16) overestimated  $N_1$  by the binomial distribution because the probability that  $N_1 > \text{ceil}(N/2)$  is zero given two surfaces, where  $\text{ceil}(N/2)$  is the smallest integer that is not smaller than  $N/2$  (Zhang 2003).

He also argues against the Millington's estimation by giving a counter example. If the room has one surface with full absorption  $S_i \ll S_{total}$ , according to Millington the particle will hit this surface  $N \frac{S_i}{S}$  times, but in fact it will be killed for hitting this surface just once. Therefore the deficiency of Millington is disclosed.

Zhang proposed the following method instead: the probability of one particle surviving from surface  $i$  is  $1 - \alpha_i \frac{S_i}{S}$ , therefore overall the particle will survive at the probability

$$\prod_{i=1}^M (1 - \alpha_i \frac{S_i}{S})$$

Hence the total energy will be expressed as

$$E(t) = E_0 \prod_{i=1}^M (1 - \alpha_i \frac{S_i}{S})^N = E_0 \exp(\frac{cS}{4V} t \sum_{i=1}^M \ln(1 - \alpha_i \frac{S_i}{S})) \quad (3.22)$$

$$T_{60} = \frac{0.16V}{S \sum_i \ln(1 - \alpha_i \frac{S_i}{S})} \quad (3.23)$$

Zhang's method is an improvement in comparison with Millington's method (3.21), but his critique on Eyring's method is not sound. As we notice from the derivation of

Eyring's equation, it allows the non-zero probability when  $N_l > \text{ceil}(N/2)$  because Eyring didn't assume the flatness of surface  $S_l$ .

However, this argument does bring to the attention that the shape and distribution of absorptive material should be compensated in Eyring's equation. This argument further justifies the necessity of Kuttruff's modification.

### **3.7 GEOMETRICAL ROOM ACOUSTICS: METHOD BASED ON RECTANGULAR ENCLOSURE**

The following introduces methods developed on the assumption of rectangular enclosure. It is stated and verified by the authors that the method can also be used for other shape. These methods are used in the context of concert hall.

#### ***3.7.1 Fitzroy's equation and Neubauer's modification***

Fitzroy proposed that the sound field may tend to develop reflection patterns involving the three major axes of a rectangular room, and that each of these patterns decay at different rates. The overall decaying will be the sum of the decays between each pair of surfaces, each contributing in proportion to the area of each pair. This is a speculative model but is quite popular due to the simplicity of its format (Fitzroy 1959; Lawrence 1970).

$$T_{60} = 0.16 \frac{V}{S^2} \left[ \frac{-S_x}{\ln(1-\alpha_x)} + \frac{-S_y}{\ln(1-\alpha_y)} + \frac{-S_z}{\ln(1-\alpha_z)} \right] \quad (3.24)$$

On the other hand, Neubauer proposed a modification for Fitzroy's formula to account for the influence of non-uniformity of the absorption materials (Neubauer 2001).

$$T_{60} = \left( \frac{0.16V}{S^2} \right) \left( \frac{S_z}{\alpha_z^*} + \frac{S_x + S_y}{\alpha_{xy}^*} \right) \quad (3.25)$$

$$\alpha^* = -\ln(1-\alpha) + \left[ \frac{\sum (1-\alpha_i)(\bar{\alpha} - \alpha_i)S_i^2}{S^2(1-\bar{\alpha})^2} \right]$$

This method does not come with enough theoretical justification, and therefore will not be considered in this thesis.

### 3.7.2 Non-uniform material distribution (Arau-Puchades 1988)

Arau-Puchades proposed an improved formula. Considering that the sound decay results from multiple sequential and simultaneous reflections on the surface of the room, Arau-Puchades reasonably assume that reflections occur more often between pairs of parallel walls and the simultaneous sound reflections are produced in adjacent perpendicular walls, the following coefficient  $\bar{a}$  is introduced to integrate the influence of sound decay in three directions.

$$\alpha_{m\text{mod}} = (\bar{a}_x)^{s_x/3} (\bar{a}_y)^{s_y/3} (\bar{a}_z)^{s_z/3} \quad (3.26)$$

$$\begin{aligned} \bar{a}_x &= -\ln(1-\bar{\alpha}_x) \\ \bar{a}_y &= -\ln(1-\bar{\alpha}_y) \\ \bar{a}_z &= -\ln(1-\bar{\alpha}_z) \end{aligned} \quad (3.27)$$

$$T_{60} = \frac{0.161V}{-S\alpha_{m\text{mod}}} \quad (3.28)$$

When the absorption coefficients does not differ with each other too much,  $\bar{a}$  can be approximated by  $\bar{\alpha}_{av} = \frac{1}{S} \sum_i S_i \alpha_i$ , which is the coefficient used in Eyring's equation.

Arau-Puchades argues that the difference between  $\alpha_{m\text{mod}}$  and  $\overline{\alpha_{av}}$  provides a measure of the anisotropy and inhomogeneity of the sound field.

### 3.8 SUMMARY ON GEOMETRICAL ACOUSTICS METHODS

**Table 3.1 Comparison of different methods**

Method	Theory	Parameters	Shape Modification	Material Assignment Modification	Scattering effect Modification
Simulation software	Geometrical acoustics	Detailed shape material properties	Yes	Yes	Yes
Sabine	Stationary State Equation	$V, S, \alpha$	No	No	No
Millington	Probability				
Zhang	Probability				
Eyring	Probability				
Arau-Puchades	Speculative	$V, S, \alpha, S_x$ $\alpha_x, S_y, \alpha_x, S_z$	No	Yes	No
Fitzroy	Empirical Speculative	$\alpha_z$		Yes	No
Kuttruff	Probability	$V, S, \alpha, S_i$ $\alpha_t$	Yes	Yes	Yes

Table 3.1 summarized the methods discussed in 3.3 through 3.6. It is recognized that geometrical shape, non-uniform material distribution and scattering effect are three important factors influencing the reverberation time.

It is also noticed that although scattering coefficient has been reported to influence reverberation time mostly from literature on simulation software (Vorlander, 1995), there is no simple method including it as predicting parameters. This thesis will try to address this problem.

Kuttruff, Fizroy/Neubauer, and Arau-Puchades equations are used to predict the influence of non-uniform material distribution on reverberation time. However, there is no consensus on the merits of these equations and this thesis will discuss them in later chapters.

### **3.9 EMPIRICAL APPROACH**

Empirical approach in concert hall design has its root in precedent-based design, and even nowadays there are several acousticians that claim to be empiricists. They criticize acoustics as inaccurate science and prefer to depend on empirical observations. The extreme approach being complete disregard of scientific theories.

Statistical method is a way to formalize the empiricist approach. An experienced consultant makes estimations based on acoustic features of existing halls. Based on the cognitive capabilities to extract rules of thumb, he/she relies on the assumed relationship between acoustic performance and general acoustical features in existing concert hall. With the development of statistical methods, this implicit cognitive process is explicated through data analysis.

The early empirical research in acoustics focuses on discovering correlation between one specific architectural parameter and certain acoustical performance index. Chiang (Chiang 1994) systematically studied the effects of architectural parameters on reverberation time and other acoustical indexes through correlation analysis, factor analysis and multiple regression methods. His research shows that some significant relations exist between architectural parameters and acoustical indexes, but a linear model cannot explain the variance of hall behavior (Chiang 1994; Gade 1996; Nannariello and Fricke 2001; Beranek 2004; Haan and Frick, 1992).

Observing the failures of linear regression models, Nannariello and Fricke (Nannariello and Fricke 1999; Nannariello and Fricke 2001; Nannariello and Fricke 2001; Nannariello and Fricke 2002) proposed to use artificial neural network (ANN) to solve the problem. ANN is known for its capability to discover complicated “patterns” and model nonlinear phenomenon. This work was more successful in predicting reverberation time and other acoustical indexes in comparison with other methods. However, as the general critique of the ANN method, the neural cells identify patterns but are not able to explicitly show them. It is not known what kind of pattern or correlations the smart black box uses. Hence it is potentially unreliable.

Overall, the criticism of the empirical method is that it does not make use of known scientific theory, and this absence of theory may result in omission of significant factors. For example, an empirical equation (3.29) is derived by Schultz to predict the sound pressure level  $L_p$  with distance  $r$  to a source sound pressure level  $L_w$  (Schultz 1985).

$$L_p = L_w - 10 \log r - 5 \log V - 3 \log f + 12 \quad (3.29)$$

This equation has good empirical match according to Schultz but confuses many people. In this equation we observe the parameter room volume  $V$ , distance  $r$ , which are supposed to be influential for sound pressure level prediction. However, it does not include absorption as a prediction parameter, which is an essential item according to theoretical equation (3.30)(Wilson, 1989). It is obvious from that equation that absorption coefficient plays a role in the sound pressure level prediction, and intuitively the larger the absorption, the smaller the sound pressure level is.

$$Lp = Lw + 10 \log\left(\frac{Q}{4\pi r^2} + \frac{4}{R}\right) \quad (3.30)$$

$$R = \frac{S\bar{\alpha}}{1 - \alpha}$$

One way to explain the empirical match of the Schultz's formula without absorption coefficient is the coincidence of empirical experimental setting. If the formula didn't reflect the mechanism of how and why things happen, its predicative power is not philosophically justified. This is the essential problem with empirical approach: even if the equation has good match with empirical data, it is under risk because this match may result from coincidence or hidden parameters.

### 3.10 SEMI-EMPIRICAL APPROACH

To take advantage of both theoretical knowledge and empirical data, this thesis approaches reverberation time prediction with semi-empirical method: First establish a simplified model, then identify calibration parameter(s) and infer its value through empirical data. The idea is that the deviation caused by the model simplification will be compensated through parameter calibration with empirical data. The coherence between

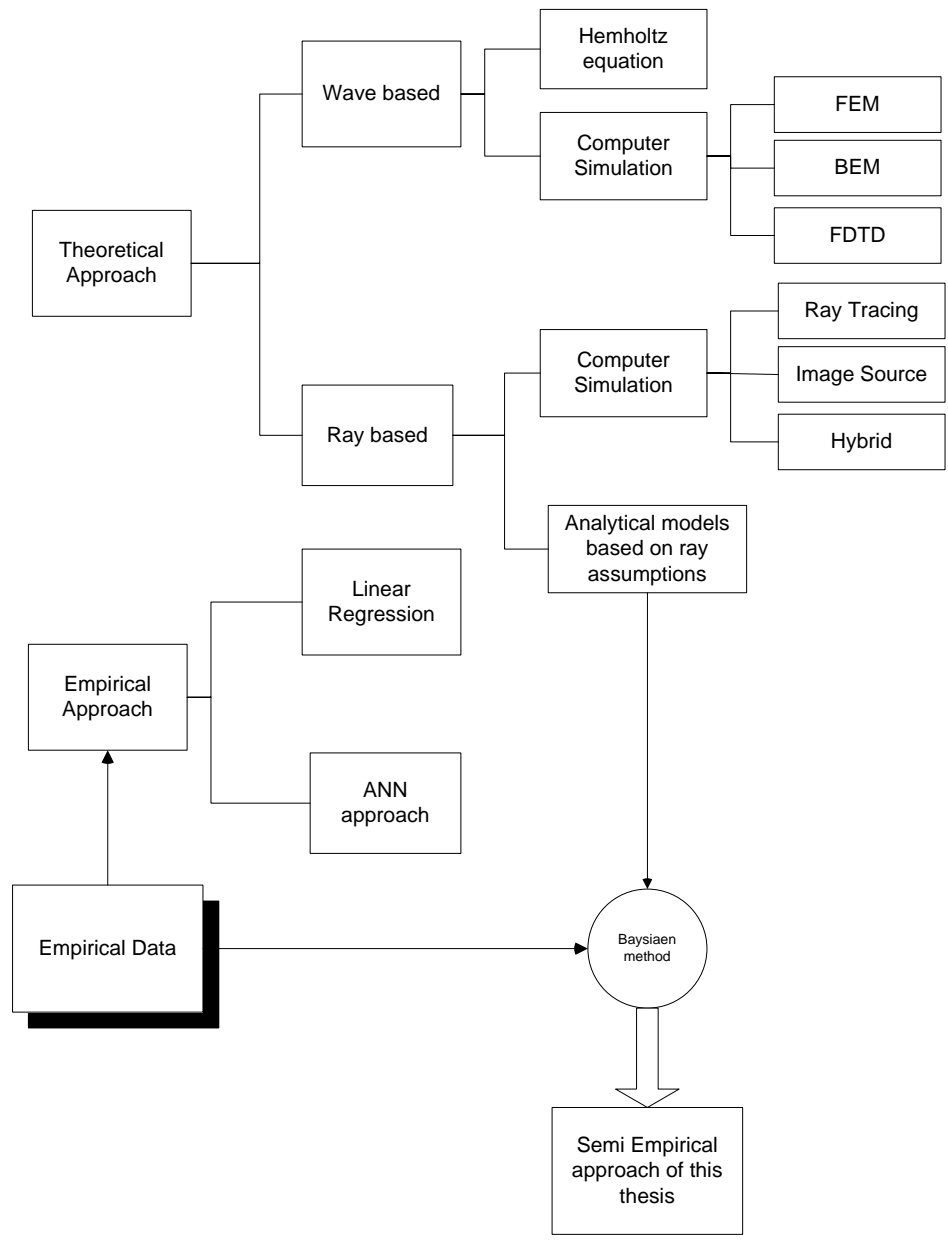


the model structure and empirical data is guaranteed by the mathematical rigor of Bayesian method. This approach and its relation with others are illustrated in Figure 3.

This thesis argues that it is an appropriate approach especially when scientific theory is practically inapplicable or when input information is not sufficiently available. It is particularly useful for reverberation time model development in preliminary design stage due to the unavailability of design information. From a broader viewpoint, the development of such a model is considered to integrate the virtue of precedent-based approach and scientific knowledge based approach.

Chapter 4 through 6 will build an improved model based on the simplified methods, especially those developed by Kuttruff, Arau-Puchades and Fitzroy. Chapter 4 investigates the shape influence based on Kuttruff equations, and derives an empirical representation of its unknown but important parameters using an acoustic simulation software (ODEON). Chapter 5 investigates the current methods addressing non-uniform material distribution problem, and concludes that the influence of non-uniform material distribution depends on scattering coefficients. Chapter 6 develops a model to incorporate the factor of non-uniform distribution and factor of scattering coefficients. Through the whole modeling process one important concern is to represent the influential factors in such a structure that it is appropriate and accessible for preliminary design stage.

Chapter 7 summarizes the model and identifies the parameters subject to calibration. Chapter 8, 9, and 10 deal with the parameter calibration of empirical data using with Bayesian method.



**Figure 3.9 Illustration of reverberation time prediction method**

## **CHAPTER 4**

### **Concert Hall Geometry and Reverberation Time**

This chapter discusses the influence of concert hall shapes on reverberation time. The model developed in this chapter will help answering questions such as: What is the reverberation time difference between a fan-shaped hall and a shoe-box hall? What is the reverberation time difference between a shoe-box with proportion 1:1:1 and 1:2:2? The answers to these practical questions will help designers to make better informed decisions.

This study is based on Kuttruff's work (Kuttruff, 1999) and uses Odeon as a research tool to perform simulation experiments. A parameter set considered important and appropriate for preliminary design stage is identified through this study. This parameter set serves as the interface between knowledge and design. In other words, it demonstrates what are the important and influential design parameters in reverberation time prediction from the geometrical perspective.

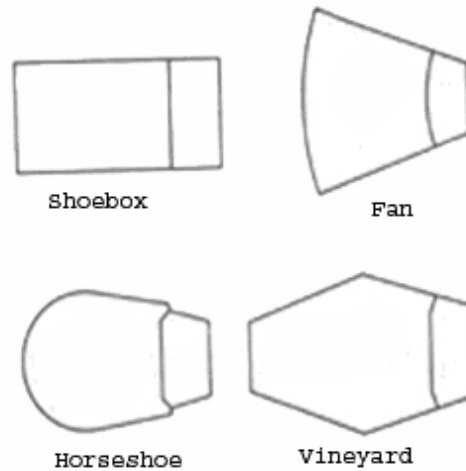
This chapter is constructed on the basis of three questions: First, how different concert hall shapes are in reality? Section 4.1 will briefly introduce the diversity of concert hall shapes and provide a basis to evaluate the shape influence. Secondly, what is the magnitude of the influence of shapes? While the necessity of modifying material distribution has been substantially recognized and proven, very few have explicitly addressed the magnitude of shape influence and its necessity in the context of concert hall design. Section 4.2 will use Kuttruff method to evaluate the influence of shape and the

necessity to include shape factor in reverberation time prediction. It is also suggested that Kuttruff's method can be used as a basis to model shape influence, as long as the free path length variance is given. Section 4.3 discusses the difficulty to estimate the free path length variance through Monte-Carlo simulation and the development in probability field to address this problem with rectangular shape. Empirical models are developed and tested for several special shapes, and based on these studies, a model is established for general shapes.

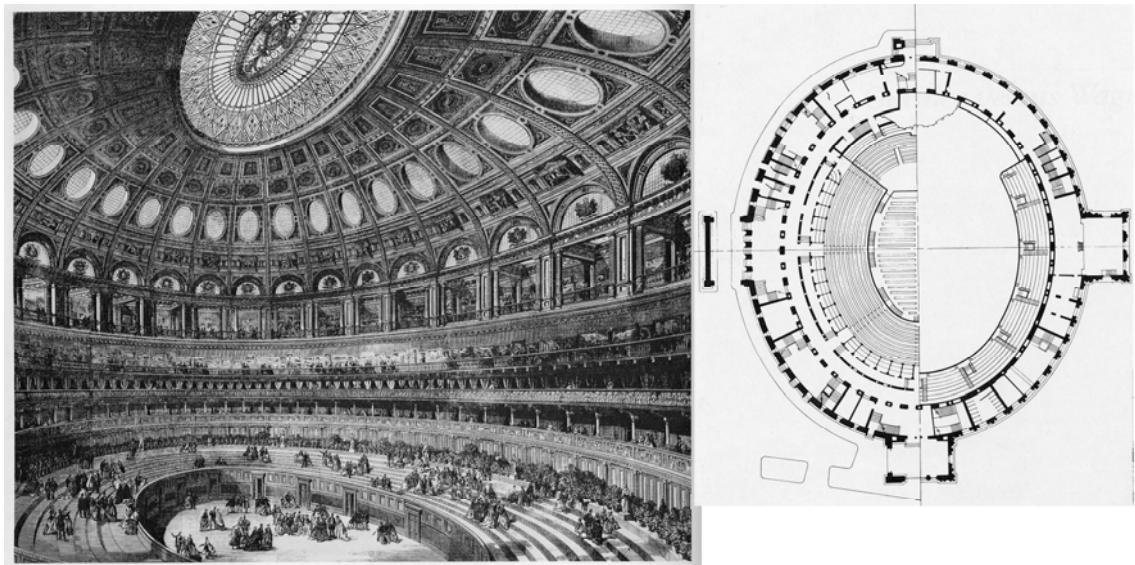
#### **4.1 CONCERT HALL SHAPES**

As shown in Fig 4.1, typical concert hall plans take a variety of shapes like shoebox, fan, vineyard and horse-shoe. Besides the influence on the length of reverberation time, other effects resulting from different shapes are also considered in acoustical design. For example, the focal effect of elliptical plan prevents it to be popular with the exception of the beloved reputation of Royal Albert Hall: A rare successful hall in this shape after many efforts from acousticians. Another mostly recognized effect is the early lateral sound. It contributes to the 'spaciousness' and is one of the main reasons that acousticians are in favor of the shoebox shape halls in contrast to fan-shaped halls.

However, this thesis is not looking at the concert hall from the overall sound quality perspective. This thesis is only focusing on the reverberation time prediction of concert halls, and therefore will restrict from addressing the early lateral reflection performance or other such important aspects.



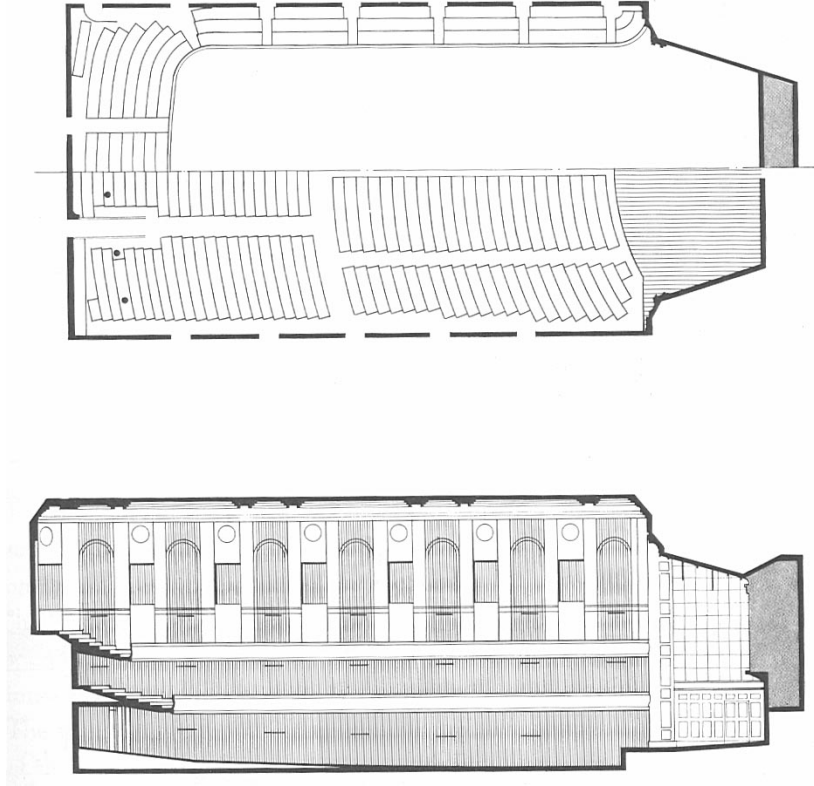
**Figure4. 1 Typical concert hall plans (Barron, 1993)**



**Figure4. 2 Royal Albert Hall (Beranek, 2004)**

A historical review of concert halls reveals that most of successful and therefore preserved concert halls built from 18<sup>th</sup> to early 20<sup>th</sup> centuries are in the shape of shoebox. In a concert hall survey performed by Beranek and Haan, two thirds rated as “excellent” are in the shape of shoebox (Haan and Fricke, 1995). For example, as shown in Fig 4.3, Boston Symphony Hall has a spatial proportion close to 1:1:2, with a length of 39m, height of 19m and width of 23m. This proportion has been retained in most of the

classical concert halls, such as Concertgebouw hall and Grosser Musikvereinssaal Hall (Barron, 1993).



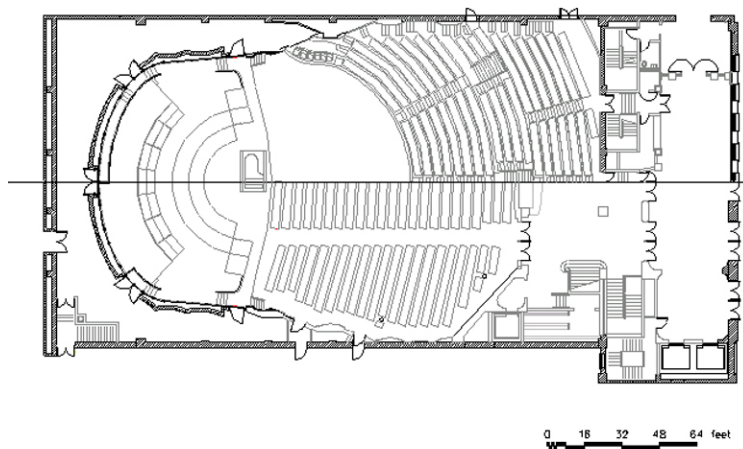
**Figure4. 3 Boston Symphony Hall (Beranek, 2004)**

Since the beginning of 20<sup>th</sup> century, architects started building acoustically successful halls of innovative shapes. Scientific methods were applied in the design process by using the principle of sound reflection and related progress in the field of architectural acoustics. For example, Berlin Philharmonic, which represents one of the most successful modern hall and also the beginning of successful vineyard plan design, develops the innovative concept of “music in the center” and achieves remarkable reputation for its acoustical qualities.



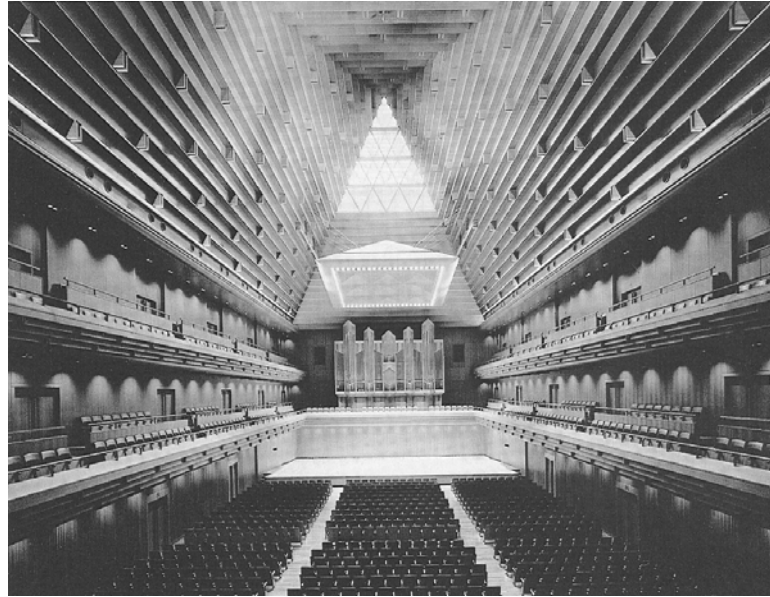
**Figure 4.4 Berlin Philharmonie Concert Hall (Beranek, 2004)**

Later on, the development of acoustical technology enables shapes deviating from the classical shoebox shape. Figure 4.5 demonstrates the shape of Orchestra Hall in Chicago. Its sound reputation is significantly improved by the application of advanced treatments.



**Figure 4.5 Orchestra Hall in Chicago (Source: Kirkegaard Associates)**

Curved surface and even triangle shapes are developed and achieved excellent sound quality (for example the NHK hall, Japan) (Hidaka and Beranek, 2000).



**Figure4. 6 Tokyo Opera City, Concert Hall (Beranek, 2004)**

Considering the proportions between length, width, and height, modern halls significantly deviate from the classical 1:1:2. They range from 5:5:1 in Tanglewood, Serge Koussevitzky Music Shed to 1:1:1 in Metropolitan Opera House (Beranek, 2004). The shape diversity makes it a possible necessary factor to be considered in reverberation time prediction. This necessity will be further discussed in the following section.

#### **4.2 NECESSITY OF SHAPE INFLUENCE MODIFICATION**

This section analyzes how much does the shape influence the reverberation time under the concert hall context according to Kuttruff's equation (equation 4.1).

$$\alpha_{s,mod} = -\ln(1-\bar{\alpha})\left[1 + \frac{\gamma^2}{2}\ln(1-\bar{\alpha})\right] \quad (4.1)$$



$\gamma^2$  is determined by the shape and introduces the influence of shape in reverberation time prediction.  $\gamma^2$  reaches the lowest value when the enclosure takes the shape of sphere. Table 4.1 makes a comparison on equivalent absorptive coefficient between a sphere and a rectangle with a proportion of 1:10:10 to observe the magnitude of the shape influence. It is noticed that the shape difference contributes about 5-20% of absorption coefficient and therefore should not be ignored in the reverberation time evaluation.

**Table 4.1 Comparison between a sphere and a rectangle**

$\ln(1-\alpha)$	$\alpha_{eq}$ for sphere	$\alpha_{eq}$ for rectangular at 1:10:10	Difference as proportion of $\ln(1-\alpha)$
0.2	0.20	0.21	5%
0.3	0.31	0.33	7%
0.4	0.41	0.45	10%
0.5	0.52	0.58	12%
0.6	0.62	0.71	15%
0.7	0.73	0.85	17%
0.8	0.84	1.00	20%

A final remark is that Kuttruff's equation cuts off the influence of third moment of free path distribution. It is reasonable because its scale is  $\frac{\gamma^3}{6}(\ln(1-\alpha))^3$ , where  $\gamma^3$  is the third moment of free path distribution (Joyce, 1975). Its influence is always less than 5%

when the average absorptive coefficient is less than 0.6, which is the case for most of concert hall settings.

The difficulty of applying Kuttruff's equation into practice is that no simple method has been supplied to compute  $\gamma^2$ . The Monte-Carlo method recommended by Kuttruff requires ray-tracing algorithm and makes it reach the complexity level of an acoustical simulation software. In the next section a simple model will be developed to compute this parameter.

#### 4.3 SIMPLE MODEL FOR FREE PATH LENGTH VARIANCE

As briefly discussed in chapter 3, the free path length variance is introduced by Kuttruff to compensate the inaccuracy in Eyring equation. As argued by Kuttruff, when substituting random variable "free path length" with a constant "average free path length" (only related with volume and surface area), the shape effect is ignored and inaccuracy is resulted. Therefore a reasonable way to account for the shape effect is through a variable which describes both average and second moment of the free path length. the

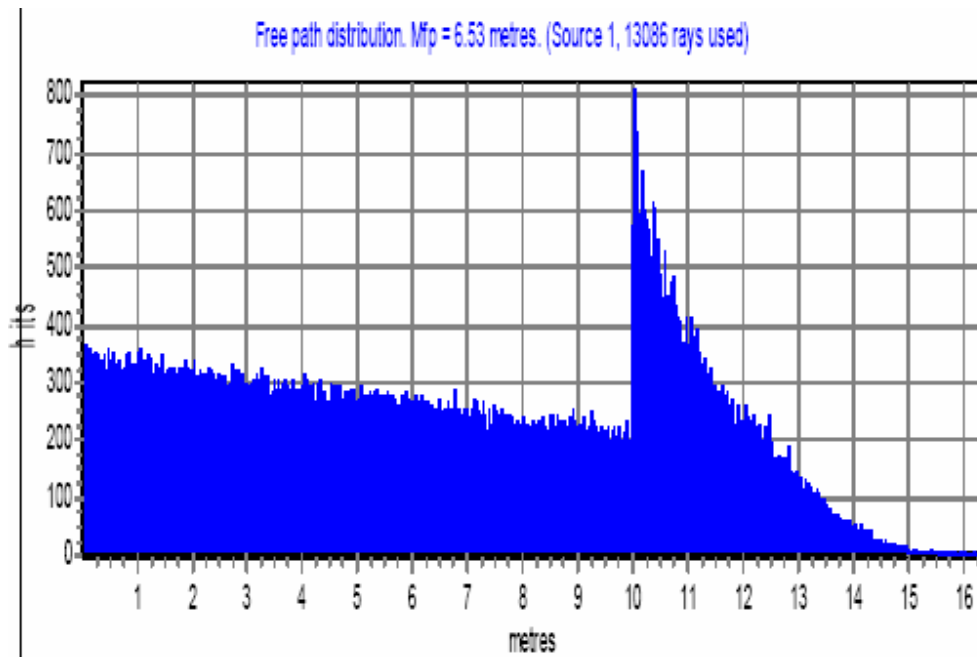
$\gamma^2 = \frac{\overline{l^2} - \bar{l}^2}{\bar{l}^2}$ . Using the terminology of probability, it can be written as

$$\gamma^2 = \frac{E(l^2) - (E(l))^2}{(E(l))^2} = \frac{Var(l)}{(Mean(l))^2}, \text{ i.e., it is the normalized variance of free path length}$$

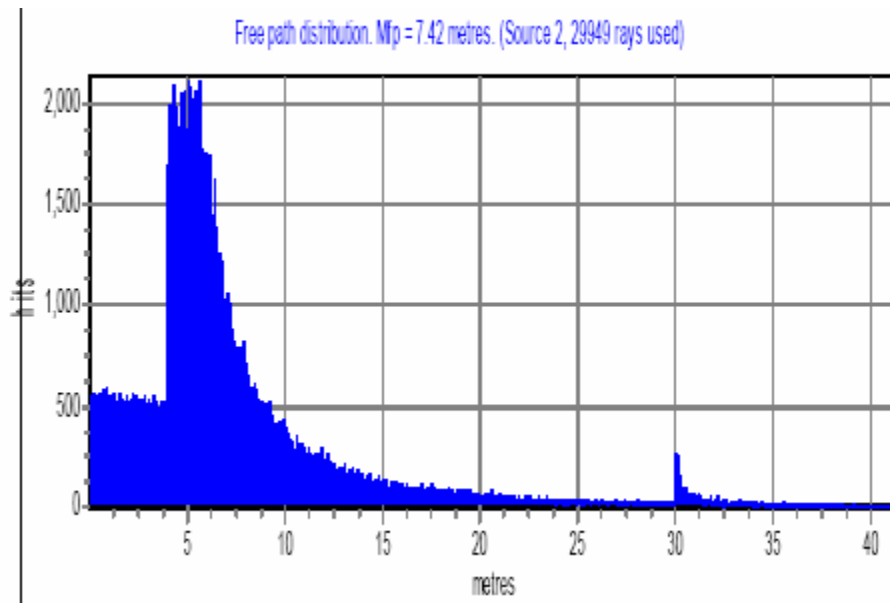
distribution.

To illustrate this difference, Figure 4.6 shows a typical free path length distribution. The x axis is the actual free path length, while the y axis is the frequency of this length among all the rays. As it can be observed, the free path length varies from 0 to 25 meters, and to use the average value (9m) to represent the whole probabilistic distribution is

certainly a compromise. To illustrate the difference, Figures 4.6 and 4.7 demonstrate the free path length distribution of two boxes. It can be noticed that the distribution in Figure 4.7 is much closer to one constant than figure 4.6 although both have the same average value. This difference between figure 4.6 and figure 4.7 can be mostly described by  $\gamma^2$ . The difference between these two distributions can be further distinguished by their third, fourth, etc. moments, but for an engineering application it has been shown in previous section that the truncation at second moment is of enough accuracy.



**Figure4. 7 Free path length distribution for a rectangular enclosure 10\*10\*10m**



**Figure4. 8 Free path length distribution for a rectangular enclosure 4\*30\*30m**

Kuttruff (Kuttruff, 1999) discussed that the free path length for one particle is same as the ensemble length distribution, and Benedetto and Spagnolo (Benedetto and Spagnolo, 1984) verified this assumption through computer simulations. It is also verified by Benedetto and Spagnolo that the free length distribution is not influenced by the location or the initial direction of the sound source. While Coleman (Coleman 1981) provides an analytical solution for any rectangular enclosure, current work lacks an analytical equation for arbitrary shape for it is a very complicated mathematical challenge. Therefore this study will use ODEON as a tool to study free path length. It

provides detailed information on the path distribution in the following format.

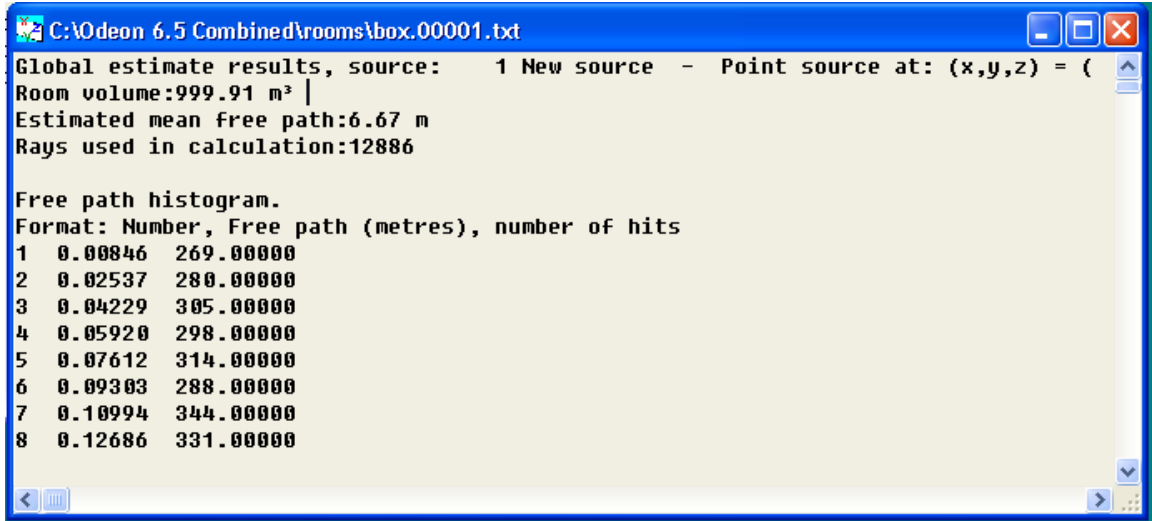


Figure 4. 9 Free Path Histogram generated by ODEON

Equation 4.1 is used to extract information on the variance of path length from the ODEON result.

$$\begin{aligned}
 N_{total} &= \sum_i n_i \\
 E(l) &= \sum_i l_i * \frac{n_i}{N_{total}} \\
 E(l^2) &= \sum_i l_i^2 * \frac{n_i}{N_{total}} \\
 \gamma^2 &= \frac{E(l^2) - (E(l))^2}{(E(l))^2}
 \end{aligned}
 \tag{4.2}$$

Thus using ODEON as a tool, the variance of free path distribution can be extracted easily. Based on the simulation result, an empirical model is derived as a simple and useful method to evaluate  $\gamma^2$ . This study starts from special shapes, then makes speculations on general shapes, and thereafter validates the results using the results from ODEON simulation.

### 4.3.1 Shoebox shape

Shoebox shape has the simplest geometry and its analytical solution is given by Coleman. However, it takes complicated form and is difficult to be implemented by designers. This section is to provide a simple formula to approximate Coleman's solution.

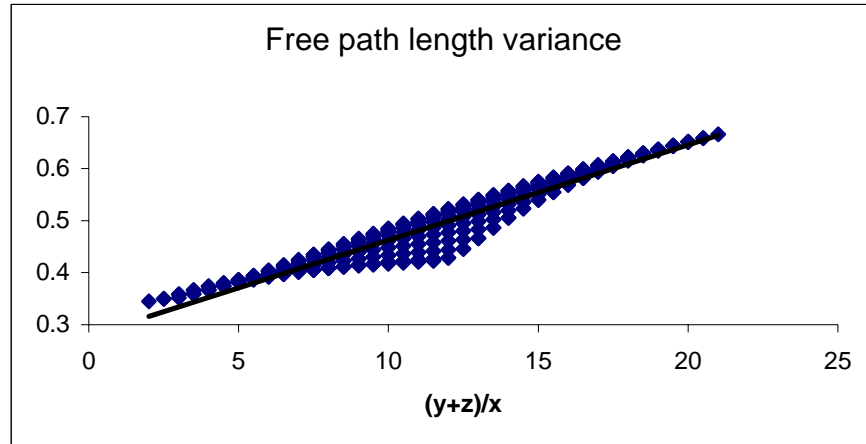
Denote the three edges of a rectangular enclosure with  $H$ ,  $W$ , and  $L$ . First of all, as proved by many researchers and also Coleman, the average free path length is

$$\frac{4V}{S} = \frac{2LWH}{(LW + LH + WH)}.$$

On the second moment  $\gamma^2$ , Coleman's formula is quite elaborate. It is noticed that although not explicit in the formula,  $\gamma^2$  is not influenced by the absolute magnitude of the enclosure, rather, it is only related with its proportion, i.e.,  $\frac{L}{H}$  and  $\frac{W}{H}$ . (Kuttruff, 1995, Coleman, 1981, Benedetto and Spagnolo, 1984).

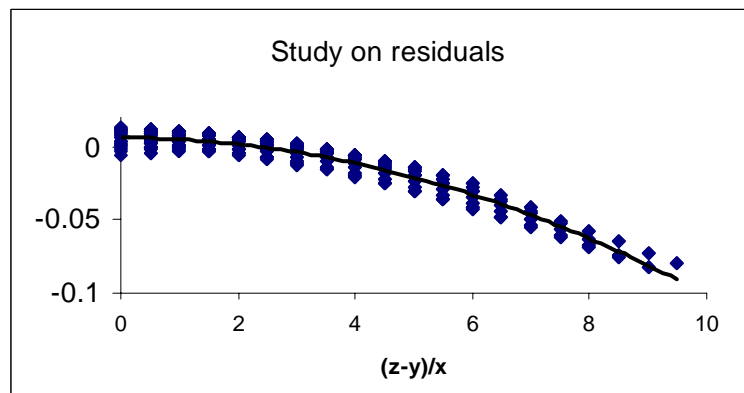
Further, according to the previous analysis, we want to restrict the scope of our analysis on rectangular enclosures ranging from 1:1:1 to 1:10:10. The preparation work is to compute  $\gamma^2$  value with  $x=1$  while  $y$  and  $z$  increase at the step of 0.01. Thus 10000 points are acquired and they serve as the basis for analysis on the derivation of empirical relation between  $\gamma^2$  and  $(\frac{L}{H}, \frac{W}{H})$ . (Benedetto and Spagnolo, 1984)

The first speculation on the empirical relation is to plot  $\gamma^2$  against  $\frac{L+W}{H}$ . The relation is demonstrated as Figure 4.9.



**Figure 4.10 Free Path Length Variance**

It is interesting to notice that there are a group of points significantly show non-linear pattern. Hence to study this phenomenon, we look at the difference between the linear regression line and the real value. After some preliminary study, it shows strong correlation with  $\frac{L-W}{H}$ . The following figure shows this pattern and the polynomial regression.



**Figure 4. 11 Residuals of the linear model**

Hence overall we consider the relation takes the shape of the following

$$\gamma^2 = \lambda_1 \frac{(L+W)}{H} + \lambda_2 \frac{(L-W)}{H} + \lambda_3 \left(\frac{L-W}{H}\right)^2 + \lambda_4 \quad (4.3)$$

Where  $\{\lambda_1, \lambda_2, \lambda_3, \lambda_4\} = \{0.0179, -0.0001, -0.0011, 0.3025\}$

By comparing this prediction with the real value it is computed that 99.8% variance of the free path length is explained by equation (4.3).

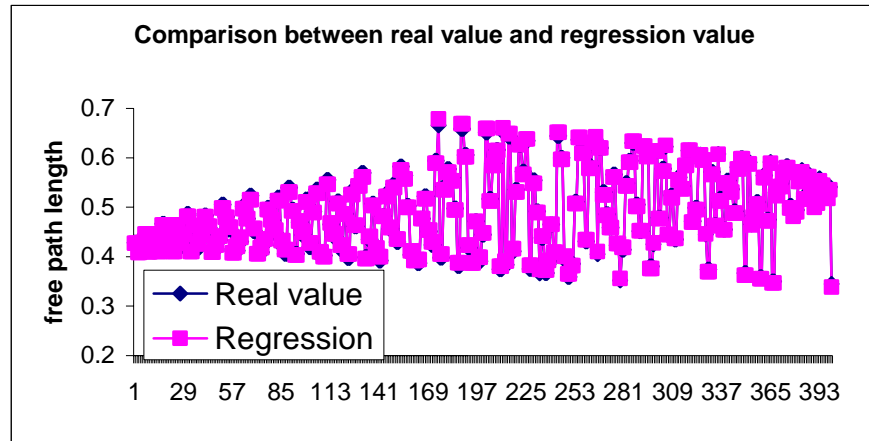


Figure 4. 12 Comparison between Real value and Model Prediction

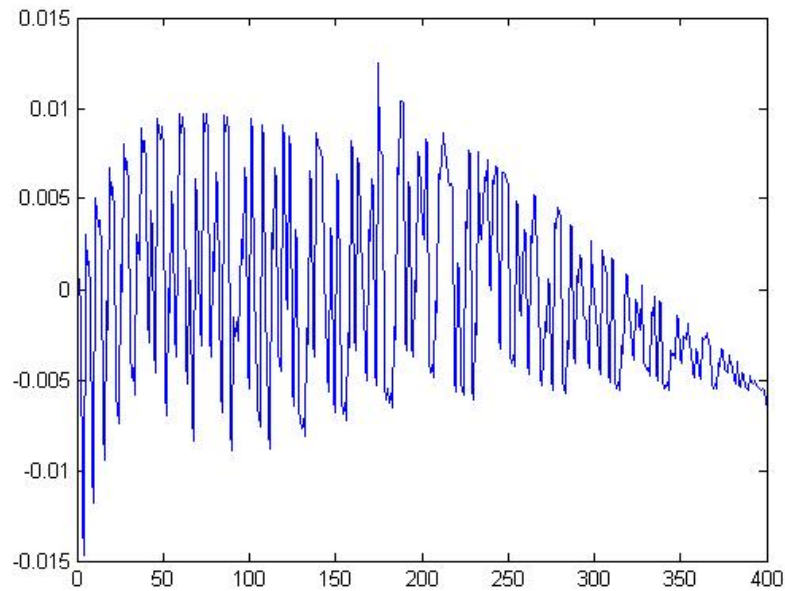


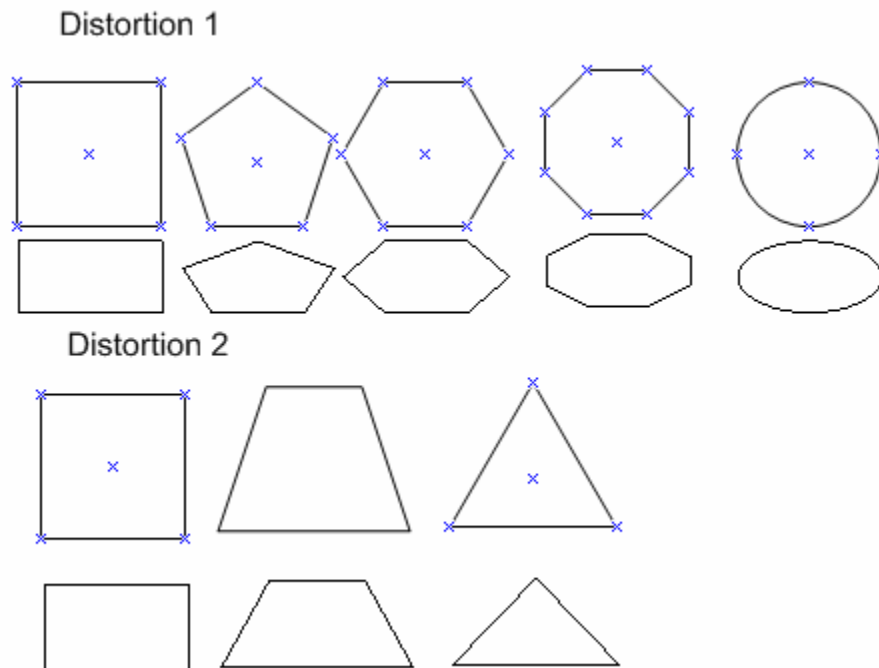
Figure 4.13 Residual from Equation (4.3)



### 4.3.2 Extruded Shape- Right Prism

This section focuses on developing a model for general extruded shapes. Considering the concert hall reality, it is reasonable to restrain our focus on the right prism, in which the top and bottom polygons lie on top of each other so that the vertical polygons connecting their sides are not only parallelograms, but rectangles. Right prism is characterized by its height and cross-section shape.

Starting from the plane with rectangular shape, the distortion of the shape demonstrate two trends as following:



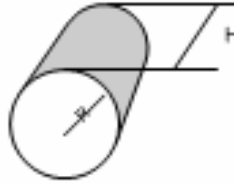
**Figure 4. 14 Two distortion trends from rectangular shape**

Thus we identify three basic cross-sections: rectangle, circle/ellipse, triangle. This thesis only considers the equilateral triangles for we assume most of concert halls are symmetrical. It is intuitive that extruded circle or ellipse will have less free path length variance than extruded triangle, and  $\gamma^2$  of most of shape resides in somewhere between

shoebox and cylinder, or somewhere between shoebox and extruded triangle, possibly depending on some parameters to be identified.

#### 4.3.2.1 Cylinder and Elliptic Cylinder

Cylinder is the extrusion of circle. To study the relation between shoebox and cylinder in the aspect of free path length variance, a comparison is made between the cylinder and its containing shoebox. When the cylinder features height H and radius R, the shoebox in concern is a box with ratio 2R:2R:H.



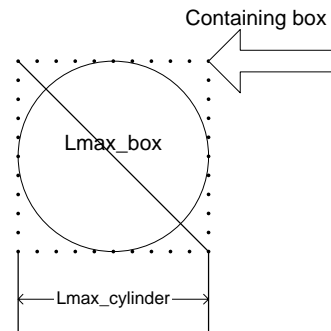
**Figure 4. 15 Description of a cylinder**

The comparison is demonstrated as the following table. It is noticed that the cylinder value/box value is close to constant, and the average is around 0.71. Since we know that the ratio between the longest length in the circle and the longest length in the containing rectangle is  $\frac{\sqrt{2}}{2} = 0.707$ , it is speculated that the free path length variance of cylinder can be computed as following:

$$\gamma_{cylinder}^2 = \gamma_{box}^2 \frac{l_{max}}{l_{boxmax}} = 0.707 \gamma_{box}^2 \quad (4.4)$$

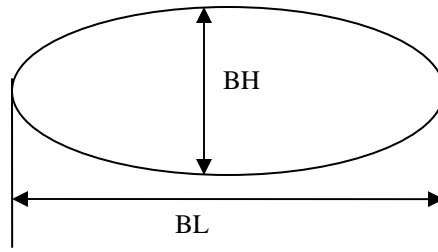
**Table 4.2. Comparison between a cylinder and its containing box**

r/h	free path length variance	containing box	Containing box free path length variance	cylinder value/box value
0.5	0.23	1,1,1	0.34	0.69
0.8	0.26	1,1.6,1.6	0.36	0.72
1	0.27	1,2,2	0.37	0.72
1.2	0.28	1,2.4,2.4	0.39	0.71
1.5	0.29	1,3,3	0.41	0.72
1.8	0.30	1,3.6,3.6	0.43	0.70
2	0.30	1,4,4	0.44	0.69



**Figure 4. 16 Cross-section of a cylinder and the box containing it**

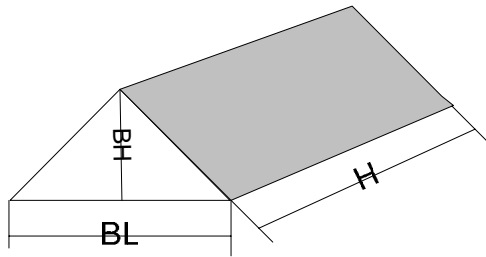
This model has also been validated with a few elliptical cylinders with the following cross-section plan controlling BL:BH ranging from (1:1) to (1:5).



**Figure 4. 17 Cross-section of an elliptical cylinder**

### 4.3.2.2 Triangular Prism

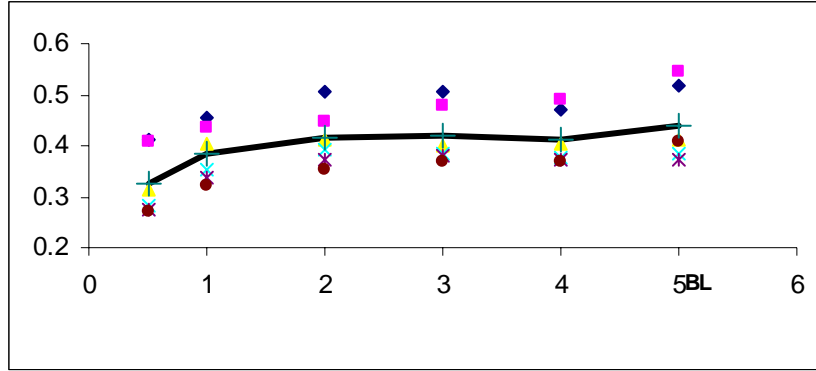
$\gamma^2$  of extruded triangle shows opposite direction in comparison with the cylinder: it is always higher than the containing shoebox. The description of extruded triangle is characterized by three parameters: height  $H$ , cross-section length  $BL$ , cross-section height  $BH$ .



**Figure 4. 18 Description of a triangular prism**

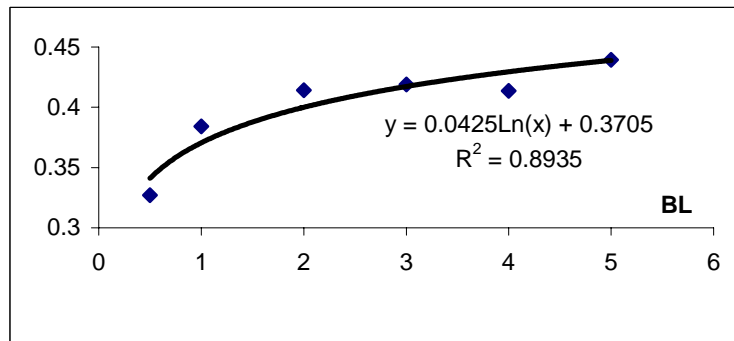
The proportion between cross-section length and height ranges from 1:0.5 to 1:5. At each proportion consider the height to be 1: 0.5 to 1:5. Therefore fixed the height  $H$  as 1, then the sampled 36 shapes is shown in Table 4.3.

This thesis is trying to provide an empirical representation of these data without introducing any mathematics rigor into the problem. By looking into the data it is noticed that the change trend of  $BL$  shows similar patten for specific  $BH$ , therefore it is proposed to develop a simplified model to first represent this trend  $f(BL)$  for the average value, and then modify it with  $g(BH)$ . The model will take the form of  $f(BL)*g(BH)$ .



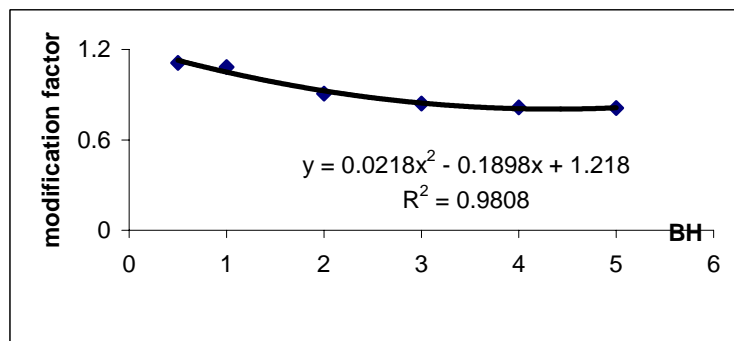
**Figure 4. 19 Empirical data of the triangular prisms**

To establish the form of  $f(BL)$ , Figure 4.19 shows the regression equation to fit the average curve.



**Figure 4. 19 Fit the empirical data with BL**

Secondly, Figure 4.20 shows the modification with factor BH.



**Figure 4. 20 Model modification**

Thus the overall empirical formula takes the following format:

$$\gamma_{tri}^2 = (\lambda_1 \ln(\frac{BL}{H}) + \lambda_2)(\lambda_3(\frac{BH}{H})^2 - \lambda_4(\frac{BH}{H}) + \lambda_5) \quad (4.5)$$

To further enhance the match between this empirical representation and the table data, a optimization problem is structured as following

$$\min_{(\lambda_1, \lambda_2, \lambda_3, \lambda_4, \lambda_5)} \left[ \gamma_{tri}^2(\lambda_1, \lambda_2, \lambda_3, \lambda_4, \lambda_5) - \gamma_{observation}^2 \right]^2 \quad \text{By Matlab Programming the}$$

optimization result is {0.0419 0.3731 0.0235 0.2036 1.3044}

And the residual between the model and real value is demonstrated in Figure 4.21.

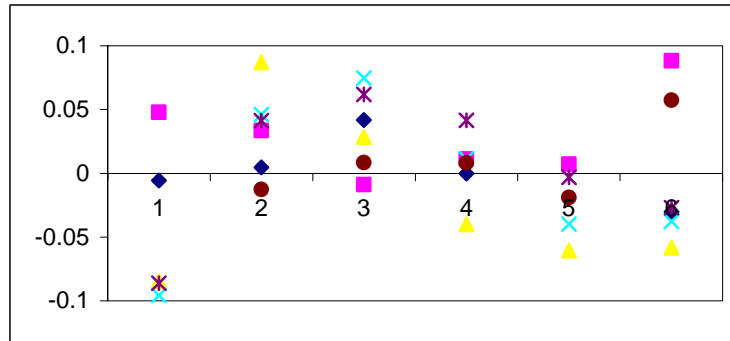


Figure 4. 21 Residual between the model and real value

Table 4.3 Simulated data for the triangular prisms

		BL					
BH		0.5	1	2	3	4	5
	0.5	0.4134	0.453	0.5072	0.5065	0.4725	0.5167
	1	0.4062	0.434	0.4481	0.4765	0.4883	0.5432
	2	0.3144	0.405	0.4103	0.3995	0.403	0.4126
	3	0.2842	0.354	0.3933	0.3837	0.3753	0.3842
	4	0.2743	0.337	0.3712	0.3787	0.3722	0.3715
	5	0.2701	0.322	0.3544	0.3693	0.3698	0.4084

### 4.2.2.3 Right Prism

After studying the special shape extruded from rectangle, circle and triangle, the remaining question is to develop some simplified model to estimate  $\gamma^2$  for shape extruded from arbitrary cross-section. Considering the plans frequently used in concert hall: fan-shaped, vineyard and horse-shoe, intuitively it is noticed that the vineyard and horse-shoe shape is “close” to ellipse, and therefore we may be able to extend the hypothesis in the cylinder case and use the maximum length to serve as the predictor. This is validated with a few shapes extruded from vineyard and horse-shoe plans.

Vineyard: the following shape is tested by controlling the relative geometrical sizes, and some example values are listed in the table.

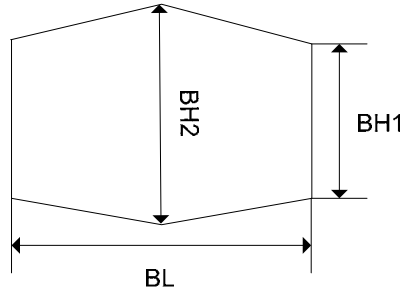
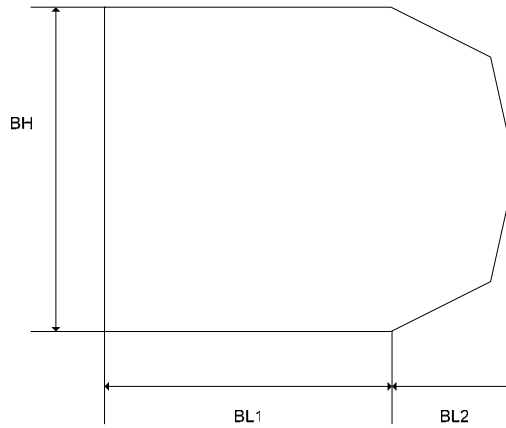


Figure 4. 22 Description of the Vineyard Plan

Table 4.4 Comparison between actual values and model predictions

	Sizes	Actual value	Prediction
v1	BH1=5, BH2=7, BL=10, H=5	0.33	0.33
v2	BH1=5, BH2=9, BL=10, H=5	0.33	0.31
v3	BH1=5, BH2=11, BL=10, H=5	0.30	0.28
v4	BH1=5, BH2=9, BL=10, H=10	0.32	0.28

Horseshoe: the following shape is tested by controlling the relative geometrical sizes, and some example values are listed in the table



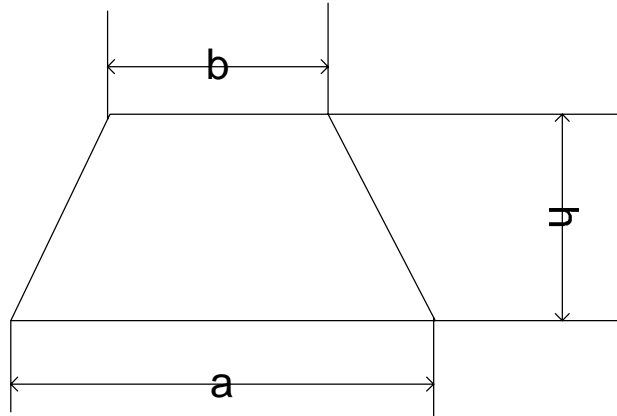
**Figure 4. 23 Description of the Horseshoe plan**

**Table 4.5 Comparison between actual value and model prediction**

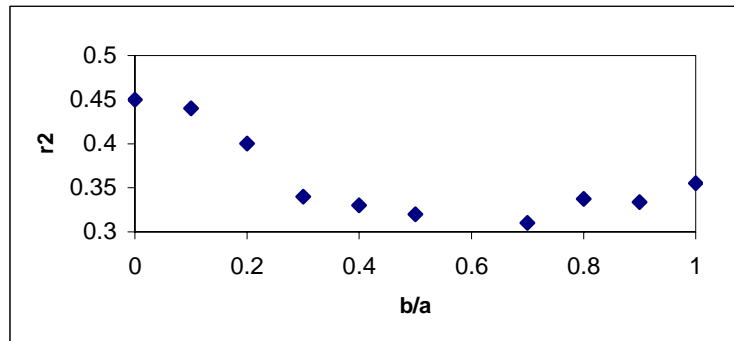
	Sizes	Actual value	Prediction
h1	BH=6, BL1=5, BL2=2.5, H=5	0.31	0.31
h2	BH=6, BL1=7, BL2=3, H=5	0.33	0.32

However, fan shapes seem to bring some complexities here. Take the following figure as example, if  $a$  and  $h$  maintains to be constant and  $b$  decreases from  $a$  to 0, then it is observed that  $\gamma^2$  decreases for a while then increases until it reaches the  $\gamma^2$  of triangular prism. To understand this phenomenon, it is speculated that in the first stage the shape grows toward ellipse and can be modeled by equation (4.5), and the second stage is dominated by the triangle trend and should have a different model. But what is the breaking point of these two stages? From where the fan shape resembles more to the cylinder than triangle prism?





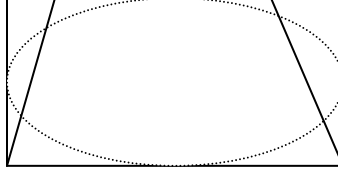
**Figure 4. 24 Description of the Fan Plan**



**Figure 4. 25 Free path length variance vs. b/a**

It is observed that the “turning point” takes place around  $b/a = 0.5-0.7$ . Although there are many other aspects to look at, the author proposes that the “turning point” takes places when the area of fan equals to the area of the ellipse which is tangent to the box containing the fan. Denote the containing rectangle has the width and length  $a$  and  $b$ , then the ellipse has area  $\frac{\pi ab}{4}$ , hence the critical proportion is  $\frac{\pi}{4} = 0.785$  and  $b=0.57a$ . It is not rigorously derived or validated, but it is a simple way to define the “turning point” of the shape.

The minimum shape triangle has the proportion  $\frac{1}{2}=0.5$ . Hence we separate this the stage is considered to be  $(0.5-0.785)$  and  $(0.785-1)$ .



**Figure 4. 26 Illustration of the two stages**

Therefore the following model is conjectured.

$$\gamma^2 = \gamma_{box}^2 * (l_{max} / l_{max_{rec}}) \text{ if } S/S_{rec} > 0.785 \quad (4.6)$$

For the stage (0.5,0.785), the two end points can be determined as the following

$$S/S_{max}=0.5 \quad \gamma_1^2 = \gamma_{tri}^2(a, c, h) \quad (4.7)$$

$$S/S_{max}=0.785, \quad \gamma_2^2 = \gamma_{box}^2 \sqrt{\frac{0.616a^2 + h^2}{a^2 + h^2}} \quad (4.8)$$

In general assuming the linear relationship, the following equation is established

$$\gamma^2 = \lambda_1 \frac{S}{S_{max}} + \lambda_2 \quad (4.9)$$

$$\text{Where } \begin{aligned} \lambda_1 &= 3.509(\gamma_2^2 - \gamma_1^2) \\ \lambda_2 &= 2.754\gamma_1^2 - 1.754\gamma_2^2 \end{aligned} \quad (4.10)$$

This model is developed through the assumption of fan shape, but will be extended to the general extruded shape.

#### **4.4 GENERAL SHAPE**

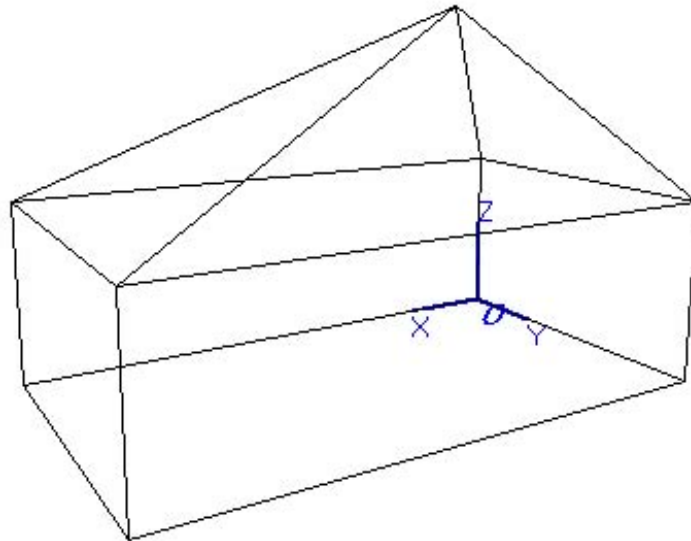
To predict the free path length variance in arbitrary shape in general is a much more complicated problem. However, most of concert halls can be reasonably approximated by

the extruded model. Even if it can not be represented by extruded model it is would not be too dramatically deviating from the extruded model.

Hence after several studies a simplified model is proposed with  $\frac{V}{V_{\max}}$  as the parameter.

$$\gamma^2 = \gamma_{\text{extrusion}}^2 \sqrt{\frac{V}{V_{\max}}} \quad (4.11)$$

To validate this model, a simple shape based on Tokyo Opera City Concert hall is constructed. The simplified geometry looks like Figure 4.27:



**Figure 4. 27 The geometrical representation for ODEON simulation**

The computed variance is 0.29. The maximum box containing this shape is (20, 22,34), thus the volume proportion between this box and this shape is .67. Plug in the relevant value the model prediction is 0.28. This serves an example to demonstrate the prediction accuracy of the developed model.

## 4.5 CONCLUSION

This chapter develops an empirical representation model for free path length variance. The model is summarized as following:

$$\gamma^2 = \gamma_{extrusion}^2 \sqrt{\frac{V}{V_{\max}}} \quad (4.22)$$

$$\gamma_{extrusion}^2 = \gamma_{box}^2 * (l_{\max} / l_{\max_{box}}) \text{ if } S/S_{box} > 0.785 \quad (4.23)$$

$$\gamma_{extrusion}^2 = \lambda_1 \frac{S}{S_{\max}} + \lambda_2 \text{ otherwise} \quad (4.24)$$

$$\gamma_{tri}^2 = (0.0419 \ln(\frac{BL}{H}) + 0.3731)(0.0235(\frac{BH}{H})^2 - 0.2036(\frac{BH}{H}) + 1.3044) \quad (4.25)$$

$$\gamma^2 = 0.0179 \frac{(L+W)}{H} - 0.001 \frac{(L-W)}{H} - 0.011(\frac{L-W}{H})^2 + 0.3025 \quad (4.26)$$

The parameters used in this model is the following

{Volume, Plan area, Maximum length, Maximum width, Maximum height, Maximum diagonal length on the plan}

This set of parameters is not too demanding for preliminary design stage and therefore should be available. Although containing some arithmetic complexity, the model is simple in the sense that there is no integration or iteration, and a very simple program will perform the computation.

In general, as free path length increases, the equivalent absorptive coefficient decreases, thus the reverberation time will become longer. It is easy to use the developed

model to observe the influence on reverberation time through design action on hall geometry.

The next chapters will discuss how reverberation time is influenced by non-uniform material distribution and scattering effect. A model will be constructed to integrate these two factors.

## **CHAPTER 5**

### **Non-Uniform Material Assignment and Reverberation Time**

Concert halls enclosing surfaces have very non-uniform absorptive coefficients. The audience surface has the heaviest absorption ranging from 0.6-1.0, and the other surfaces typically have absorptive coefficients ranging from 0.05-0.2. The effect of this non-uniform absorption distribution is not negligible, as have been recognized and paid sufficient attention by the research community (Mehta and Mulholland, 1976, Kostek and Neubauer, 2002). Concert halls have very non-uniform absorptive coefficients for enclosure surfaces. The audience has the heaviest absorption ranging from 0.6-1.0, and the other surfaces typically have absorptive coefficients ranging from 0.05-0.2. The effect of this non-uniform absorption distribution is not negligible, as have been recognized and paid sufficient attention by the research community (Mehta and Mulholland, 1976, Kostek and Neubauer, 2002). In fact, it is considered as a significant reason that the material does not perform as expected in reality.. In fact, it is considered as a significant reason that the material does not perform as expected in reality.

As discussed earlier in Chapter 3, several simplified methods are developed for reverberation time prediction in considering this effect, but there is a lack of consensus on their prediction power and an explanation on their difference. This chapter is intended to make a comparison among these methods, analyze their theoretical assumptions, and suggest the appropriate context to apply these equations. Through the study it is found that the effect of non-uniform material distribution is closely related with the surface scattering coefficients, and the popularly used equations are only suitable for space with

surfaces with certain scattering coefficients range. Hence to have a generally applicable model, it is necessary to introduce scattering coefficient in reverberation time prediction along with the consideration of non-uniform material distribution. Next chapter will focus on developing such a model.

## 5.1 METHOD EVALUATION

This thesis studied the prediction results of Kuttruff, Arau-Puchades and Fitzroy equations. It is noticed that the modification of Arau-Puchades/Fitzroy and Kuttruff go opposite directions. That is to say, as the distribution of material goes to more inhomogeneous, Kuttruff's method always predicts the absorption larger than arithmetic average, while Fitzroy and Arau-Puchades' method always predicts it to be smaller.

To demonstrate this difference, we use an example of a rectangular enclosure with proportion 2:1.5:1. Let all surface has absorption coefficient 0.1, except that one surface (length\*width) with variable absorption coefficient  $\alpha_{var}$ , which is assigned according to column 1 of Table 5.1. After computing the equivalent absorption coefficient based on three different methods, column 2 through 4 in this table shows the deviation percentage of this prediction value from the arithmetic average, which is calculated by

$$\frac{(\alpha_{prediction} - \alpha_{av})}{\alpha_{av}} * 100\% . \text{ It is noticed from the result that } \alpha_{kuttruff} > \alpha_{av} > \alpha_{aura} > \alpha_{Fitzroy} .$$

**Table 5.1 Comparison among three methods**

Absorption coefficient	Kuttruff	Aura	Fitzroy
0.4	0.1	-9.3	-19.8
0.5	1.6	-12.8	-27.1
0.6	3.5	-15.9	-33.6
0.7	5.9	-18.7	-39.3
0.8	8.7	-21.2	-44.4
0.9	12.0	-23.4	-48.8
1	15.9	-25.3	-52.8

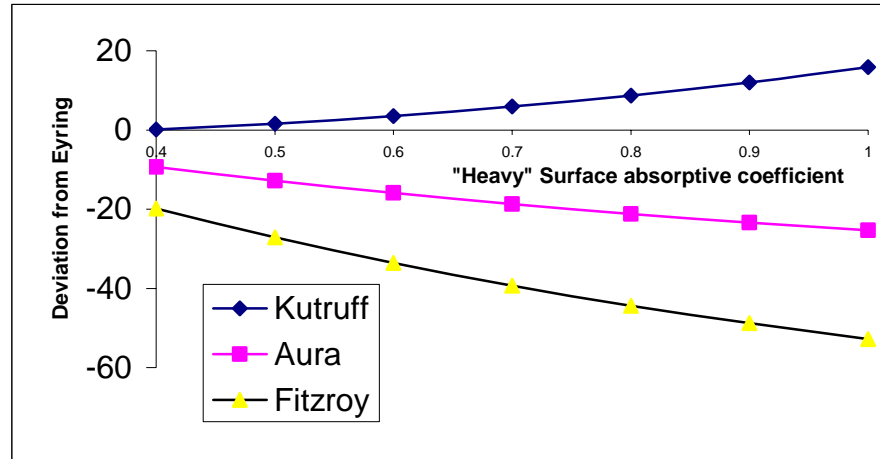


Figure 5. 1 Comparison of the predictions of Kuttruff, Arau-Puchades, and Fitzroy equations

To explain the difference in prediction results we need to go back to the theoretical foundation of these three methods. First of all, it is immediately noticed that Kuttruff's method is derived from the assumption of completely diffusive surfaces. As introduced in Chapter 3, the essential key step in derivation is that the irradiation strength of each surface is proportional to  $\sum_1^N \rho_i S_i - \rho_n S_n$ . The validity of this step is guaranteed by the diffusive assumption. Therefore it is clear that Kuttruff's material modification is only for enclosures with completely diffusive surfaces.

Fitzroy derived his formula based on the concept of "reflections in pairs". He viewed the sound decaying process in the enclosure as "a pattern of simultaneous oscillation along a rectangular room's three major axes – the vertical, the transverse, and the longitudinal". He further justified the assumption "the reverberation time influence of each pair is effective only in proportion to that pair's ratio to the whole". The grounding speculative picture, however, as we can imagine, can only be close to the reality when the surface is reflective. If the surfaces are diffusive, the picture of sound decaying pattern



should be more uniform in every direction rather than dominated in any axial direction. Therefore the hypothesis is that Fitzroy formula fits well for enclosure with reflective surfaces (Fitzroy, 1959).

Arau-Puchades's formula is also based on a speculative model. The difference between his and Fitzroy's model is that Fitzroy assumes only sequential reflections in three directions, while Arau-Puchades considers both sequential and simultaneous reflections. He considers that sequential sound reflections occur mainly between pairs of parallel walls and the simultaneous sound reflections occur in adjacent perpendicular walls. With this picture in mind he uses  $\frac{x}{(a_x)^S} \frac{y}{(a_y)^S} \frac{z}{(a_z)^S}$  to model the contributing decaying rate of both sequential and simultaneous reflections. If we consider Arau-Puchades' speculation from the perspective of diffusive or reflective surface, we should rank the surface diffusivity in Arau's model as between Kuttruff and Fitzroy's model. That is to say, from the theory background we conclude that Kuttruff applies when surfaces are diffusive, Fitzroy applies when surfaces are reflective, and Arau applies for somewhere in between.

This conjecture intuitively explains the difference in prediction results. When the surfaces are completely diffusive, the sound absorption contribution from any specific surface to sound rays reflected from each other surface are equal and with no discrimination. However, when the surfaces are completely reflective and the dominant axial absorptions are developed, any specific surface only makes contribution to its opposite surface, and makes little contribution to the rest of surfaces. When the absorption materials are not uniformly assigned, the surface with high absorptive coefficient is very much underutilized in comparison with diffusive cases. Hence the

equivalent sound absorption in reflective case should be significantly lower than diffusive surfaces and the discrepancy develops as the material becomes less uniform.

Empirically the phenomenon has been observed by Lam, Hodgson, and many other researchers in comparing simulation results with real measurement. (Lam, 1994, Hodgson, 1991, Vorlander, 1995) They noticed that without considering scattering, i.e., the simulation results tend to overestimate the reverberation time. The more unevenly distributed materials are, the more deviations are observed. (Haan and Fricke, 1997, Haan and Fricke, 1993) As we know the ray-tracing method without diffusive components assumes the completely reflective surfaces, this observation supports the previous arguments on the role of surface diffusivity in these three models.

This conjecture also explains the reported observations that under the controlled experimental conditions Arau-Puchades' formula has the best prediction and Fitzroy's formula fits better than Kuttruff's formula. (Mehta and Mulholland, 1976) Since these experiments are designed to observe the effect of non-uniformly distributed material, the enclosure surfaces are not under any special treatment, usually are flat surfaces. Therefore they are of low surface diffusivity, closer to the reflective prediction than diffusive prediction.

Based on this conjecture, this thesis focuses on the validity of Kuttruff and Fitzroy's models for completely diffusive and reflective surfaces, and develops a simplified approximate method to make predictions for auditorium settings.

## **5.2 ADJUSTMENT FOR PRACTICE**

A remark following method evaluation is how to apply Fitzroy or Arau-Puchades' method in practice. Although it is relatively easy to apply it in classical shoebox shape

hall, as used as examples by Arau-Puchades, modern halls take a variety of shapes as discussed in previous chapter. As illustrated in Fig 5.2, the hall shapes can deviate from rectangle so significantly that people will not have consensus on what count as  $S_x$ ,  $S_y$  and  $S_z$ . Furthermore, when the seats are aligned the side balcony, should the absorption be considered as side contribution or vertical contribution? These are all vague problems to be answered before applying this method to reality.



**Figure5. 2 Christchurch Town Hall (Beranek, 2004)**

We notice that the assumption in Arau-Puchades' method is to consider the overall sound decaying composed of three direction decaying. In concert hall, the dominate sound decaying process always comes from the reflection between audience and the ceiling. No matter where the seat is, unless there is a detailing flaw, the audience receives most sound reflection from the ceiling. The ceiling in a hall is always identifiable and therefore the applicability of this formula is justified.

With this assumption we restructure the formula in the following form for irregular shape:

Fitzroy's formula

$$\alpha_{eq} = \frac{-S_{ac}}{S \ln(1 - \alpha_{ac})} + \frac{-S_{en}}{S \ln(1 - \alpha_{en})} \quad (5.1)$$

Arau-Puchades' formula:

$$\begin{aligned} \alpha_{eq} &= (\overline{a_{ac}})^{S_{ac}/S} (\overline{a_{en}})^{S_{en}/S} \\ \overline{a_{ac}} &= -\ln(1 - \alpha_{ac}) \\ \overline{a_{en}} &= -\ln(1 - \alpha_{en}) \end{aligned} \quad (5.2)$$

The rationale behind this formula is to consider the sound decaying process as the composition of ceiling-audience and among-surrounding-enclosures. This speculation can also find support from the argument on “almost-two-dimensional sound field” by Tohyama et al. (Tohyama et al., 1995). In this thesis this convention will be used consistently.

### 5.3 COMPARISON WITH SIMULATION

The previous section suggests the applicability of the three models based on their explicit of implicit assumptions in model development. This section further supports this conjecture through ODEON simulation data.

In calculation parameter setup menu, ODEON provides the option of computing the reverberation time with three scattering method: None, Lambert, Full Scatter. When choosing “none”, the software will treat all the surfaces as completely reflective. When choosing “Full scatter”, the software will treat all the surfaces as completely diffusive. When choosing “Lambert”, the scattering coefficient assigned on surfaces will be used to moderate the proportion between scattering rays and reflective rays. It is to be pointed

that when Lambert method is chosen, rays hit surface and reflect in all directions according to Lambert distribution, but ODEON will not generate all these reflected rays. Instead, only one reflected ray will be generated and its direction is determined by a random number generated with Lambert distribution.

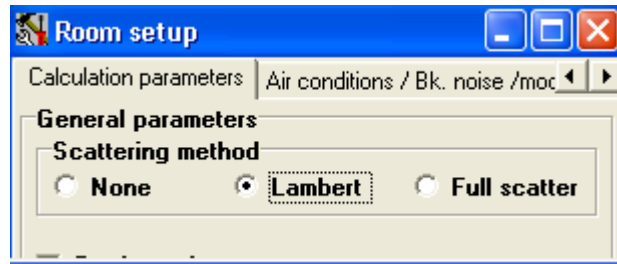


Figure 5.3 ODEON setup

### 5.3.1 Kuttruff Equation

The following shape is used as an example to compare Kuttruff equation prediction and the ODEON result. It is not intended to rigorously validate the matching between Kuttruff equation and ODEON simulation, but to provide a rough picture on how close these two predictions are. All the surfaces are assigned with absorptive coefficient 0.1, while the audience surface is assigned with coefficient from 0.6 to 0.95. The following table and figure demonstrate the comparison between Kuttruff prediction and simulation result.

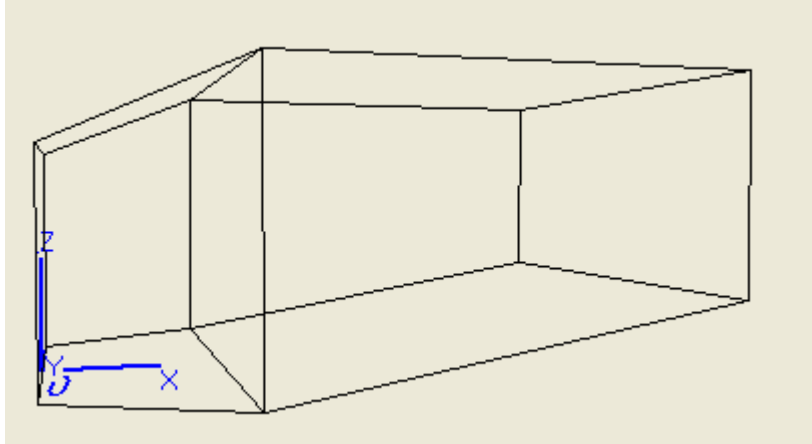


Figure 5.4 An Example used for Odeon simulation

Table 5.2 Comparison between Kuttruff prediction and ODEON result for diffusive surfaces settings

Heavy surface	Kuttruff	ODEON
0.60	0.28	0.27
0.65	0.30	0.28
0.70	0.31	0.30
0.75	0.34	0.33
0.80	0.37	0.36
0.85	0.39	0.39
0.90	0.42	0.41
0.95	0.45	0.44

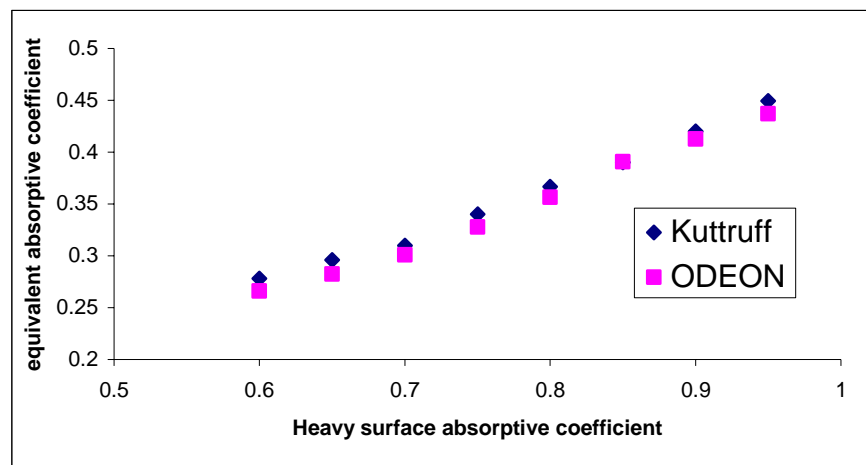


Figure 5.5 Comparison between Kuttruff prediction and simulation result

### 5.3.2 Comparison between Arau-Puchades and Fitzroy Equations

It has been argued in previous section that from the theoretical viewpoint Fitzroy fits better than Arau-Puchades to serve the structure of this thesis. This section is to compare the predictions of these two equations with ODEON simulation results when the option is set as no scattering.

To test the performance of these two equations, three box shapes are tested, with proportion of 1:1:1, 1:2:2, 1:1:2 separately. All the surfaces are assigned with absorptive coefficient 0.3, while the “heavy” surface is assigned with coefficient listed in first column. The results are demonstrated in the following.

It is noticed that either method matches very well with the simulation result, but Fitzroy’s method performs slightly better than Arau-Puchades. In considering its theoretical virtue, this thesis chooses Fitzroy’s method as a basis to predict reverberation time for enclosures with completely reflective surfaces.

**Table 5.3 Comparison among Arau-Puchades, Fitzroy predictions and ODEON simulation for a Box of proportion 1:1:1**

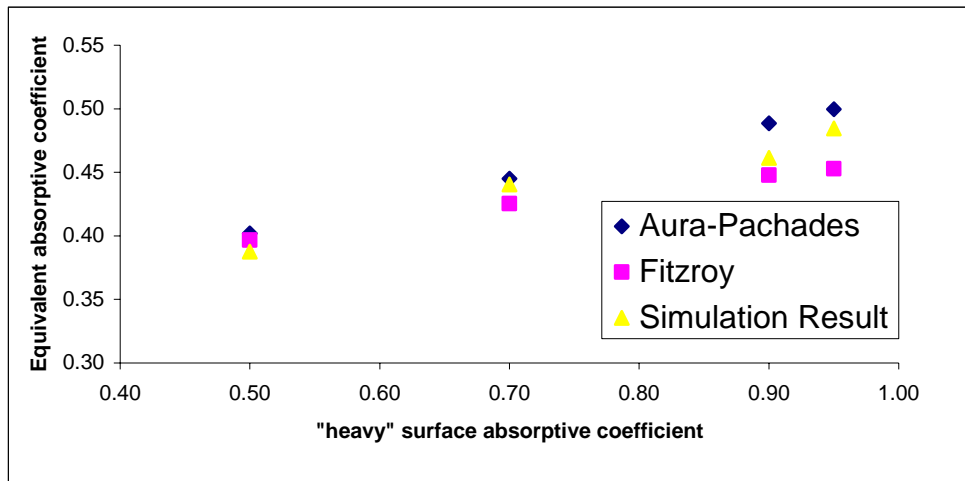
Heavy surface	Arau-Puchades	Fitzroy	Simulation result
0.50	0.40	0.40	0.39
0.70	0.45	0.43	0.44
0.90	0.49	0.45	0.46
0.95	0.50	0.45	0.48

**Table 5.4 Comparison among Arau-Puchades, Fitzroy predictions and ODEON simulation for a Box of proportion 1:1:2**

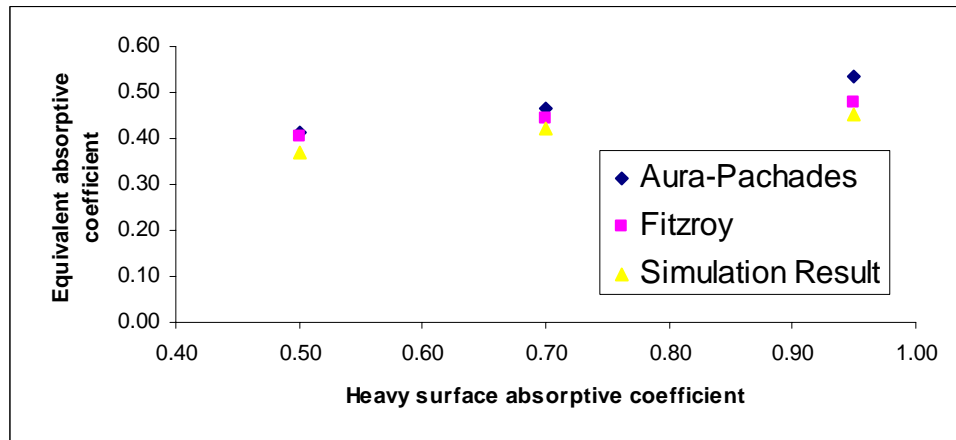
Heavy surface	Arau-Puchades	Fitzroy	Simulation result
0.50	0.42	0.41	0.38
0.70	0.48	0.46	0.40
0.80	0.52	0.48	0.43
0.90	0.55	0.50	0.45

**Table 5.5 Comparison among Arau-Puchades, Fitzroy predictions and ODEON simulation for a Box of proportion 1:2:2**

Heavy surface	Arau-Puchades	Fitzroy	Simulation Result
0.5	0.43	0.42	0.35
0.7	0.50	0.47	0.37
0.8	0.53	0.49	0.39
0.9	0.57	0.51	0.41
0.95	0.59	0.52	0.44

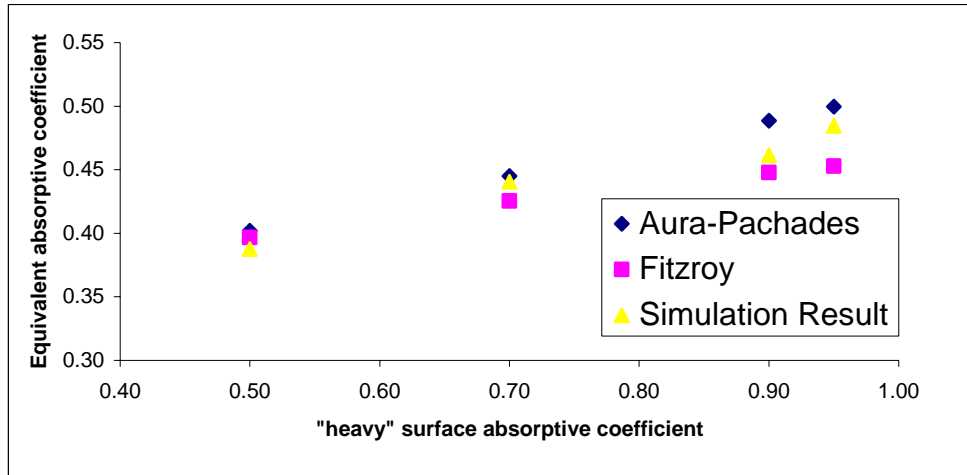


**Figure 5.6 Comparison among Arau-Puchades, Fitzroy predictions and ODEON simulation for a Box of proportion 1:1:1**



**Figure 5.7 Comparison among Arau-Puchades, Fitzroy predictions and ODEON simulation for a Box of proportion 1:1:2**





**Figure 5.8 Comparison among Arau-Puchades, Fitzroy predictions and ODEON simulation for a Box of proportion 1:1:2**

#### 5.4 CONCLUSION

This chapter shows that scattering effect moderates the influence of non-uniform material distribution on reverberation time. Kuttruff equation is appropriate for predicting enclosures with diffusive surfaces, and Fitzroy's equation is appropriate for enclosures with reflective surfaces. A model will be developed on the basis of these two equations to predict the real concert hall performance.

## CHAPTER 6

### Scattering Effect

This chapter will develop a model for reverberation time prediction integrating the scattering effect and non-uniform material distribution. The following questions will be addressed:

- How to include scattering coefficient as a predicting parameter in a simple analytical model based on Fitzroy and Kuttruff equation?
- How to assign frequency-dependent scattering coefficient for surfaces in the preliminary design stage?

#### 6.1 CONCERT HALL INTERIOR SURFACE DIFFUSIVITY

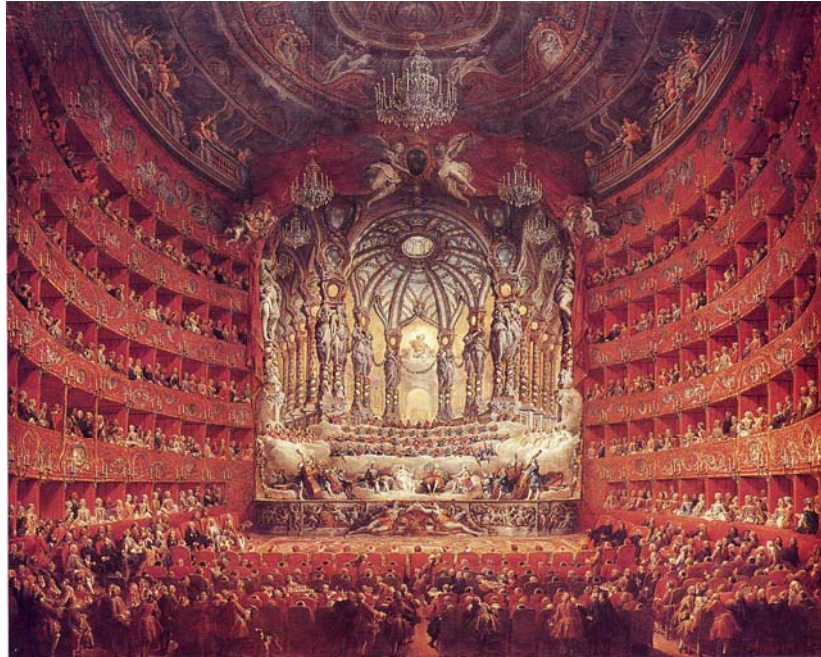
Scattering is used as a general term to describe the phenomenon that wave spreads in different directions. In concert hall settings, it is an important phenomena when sound wave encounters the surface diffusivity - geometrical irregularities, coffers, and projections. “Scattering coefficient” is used to quantify the proportion of non-specular scattered energy to the energy that is not absorbed by the surface. Denote it as  $D$ , then it is defined as following for surface with absorptive coefficient  $\alpha$  (Vorlander and Mommertz, 2000):

$$\begin{aligned} E_{spec} &= (1 - \alpha)(1 - F)E_{inc} \\ E_{total} &= (1 - \alpha)E_{inc} \\ F &= 1 - \frac{E_{spec}}{E_{total}} \end{aligned} \tag{6.1}$$

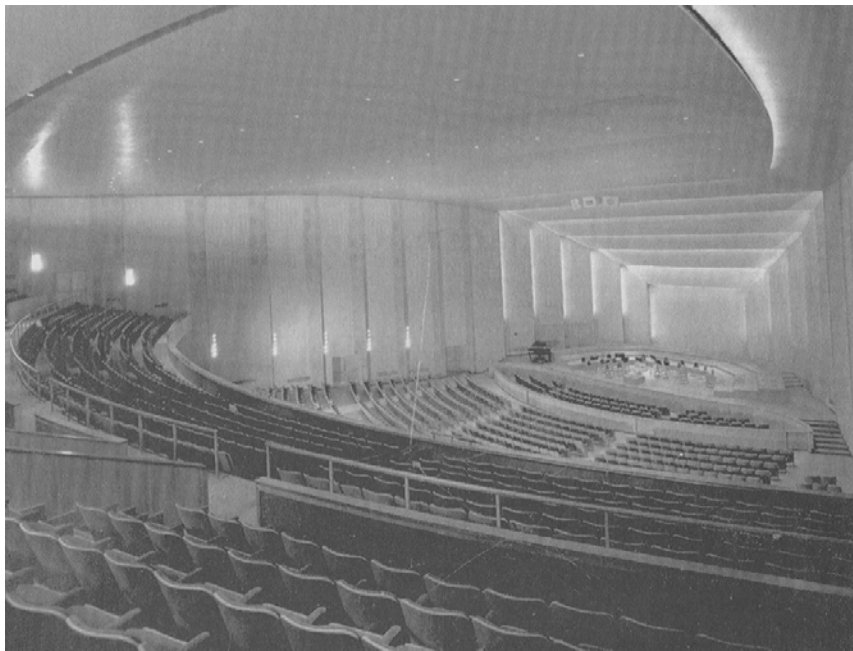
Where  $E_{spec}$  is the specularly reflected energy,  $E_{total}$  is the total reflected energy, and  $E_{inc}$  is the incidental energy.

Surface diffusivity and the resultant scattering effect is favored by acousticians for it spread sound to all directions to avoid “sound glare” and other unpleasant sound quality. It also helps to build the perception that sound comes in all directions. Beranek even define “sound diffusivity index” as one performance index to evaluate auditorium sound quality. (Haan and Fricke, 1997)

From the architectural viewpoint, the surface diffusivity has one of the most important interfaces with interior decoration style. The classical aesthetics drives architects to design halls with elaborate ornaments and statues, and they facilitated the high diffusivity surfaces and unconsciously resulted in the refined sound quality in halls like Concertgebouw and Vienna Grosser Musikvereinssaal Hall. As Cox and Antonia pointed, the post war modern style featuring plane and smooth surfaces has resulted in less scattering coefficients (Cox and D'Antonio, 2003). This thesis will discuss the influence on reverberation time prediction resulted from a large variety of surface diffusivities in existing auditorium styles. The following figures demonstrates the contrast of halls with very diffusive and very reflective surfaces.



**Figure 6.1** Concert to celebrate the birth of the dauphin: oil painting by Giovanni Paolo Panini, 1729



**Figure 6.2.** Kleinhans Music Hall, Buffalo (Beranek, 2004)

## **6.2 SURFACE DIFFUSIVITY AND WAVELENGTH**

The scattering effect is related with geometrical irregularity scale, wave length and incidental angle. Scientifically speaking the scattering coefficient is not an “intrinsic property” of a material, but depends on the relative magnitude between material roughness and the incidental wavelength. (Ogilvy, 1991)

In general the scattering effect strengthen as the relative magnitude difference between geometrical projections and wavelength increases. For one specific hall with fixed geometrical irregularities, the scattering effect should strengthen as the wavelength decreases. If the predictions by Kuttruff and Arau-Puchades are computed, the observed real reverberation time should be somewhere in between these two predictions, and moves closer to Kuttruff prediction as wavelength decreases or frequency increases.

To demonstrate this effect, a case study on Boston Symphony Hall is conducted. Boston symphony hall is considered as one the best music halls in the world with compliments from famous conductors like von Karajan, Bernstein and Leinsdorf . The sound is clear, live, warm, brilliant and appropriately loud. The following lists some technical parameters for Boston Symphony Hall.



**Figure 6.3 Boston Symphony Hall (Beranek, 2004)**

**Table 6.1 Technical Parameters of Boston Symphony Hall**

	Material
Ceiling	19mm plaster on metal screen
Walls	30% plaster on metal lath, 50% on masonry backing and 20% of 1.25-2.5mm thick wood, including the stage walls
Floors	Flat concrete with parquet wood affixed
Carpets	Thin on main aisles
Audience	The front and rear of the backrests and the top of the seat bottoms are leather over hair, the under seats and the arms are of solid wood

A parameter P is introduced to assess the relevant distance of the measured absorptive coefficient value between Kuttruff and Arau-Puchades prediction.

$$P = \frac{\alpha_k - \alpha_m}{\alpha_k - \alpha_f} \quad (6.2)$$

$$\alpha_m = \left(0.161 \frac{V}{T_m} - \frac{4mV}{S}\right)$$

There are three groups of independent measured reverberation time data available for Boston Symphony Hall as following:

**Table 6.2 Measured reverberation time for Boston Symphony Hall**

Source	125Hz	250Hz	500Hz	1000Hz	2000Hz	4000Hz
Hidaka/Beranek(1992)	1.80	1.90	1.80	1.80	1.70	1.40
Griesinger/Kirkegaard(1993)	2.10	1.80	1.90	1.90	1.60	1.20
Beranek(1997)	1.95	1.90	1.90	1.95	1.59	1.43

The predicted reverberation time by Kuttruff and Fitzroy methods are listed in Table 6.3.

**Table 6.3 Predicted reverberation times with Kuttruff and Fitzroy methods**

	125Hz	250Hz	500Hz	1000Hz	2000Hz	4000Hz
Kuttruff	1.70	1.55	1.64	1.69	1.55	1.36
Fitzroy	2.40	2.74	3.25	3.73	3.24	2.35

It is demonstrated that the predictions by two methods differ significantly, and the real measured value stays somewhere in between and moves closer to the Kuttruff

prediction as frequency goes up.  $P$  values are plotted to show the measured value against the frequency.

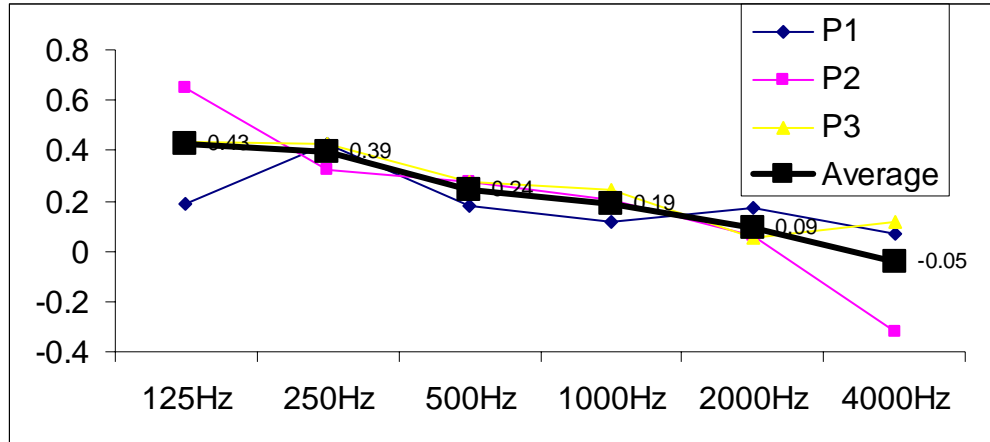


Figure 6.4  $P$  value inferred by measurement data

This trend can be intuitively illustrated as following:

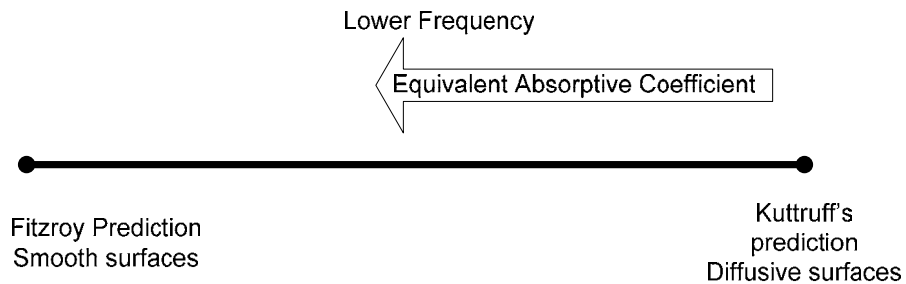


Figure 6.5 Illustration of relevant relation among equivalent absorptive coefficient, Fitzroy prediction and Kuttruff prediction

### 6.3 ANALYTICAL SOLUTIONS

From the viewpoint of wave theory, the speculative reflection on smooth surface will result in the coherent sound field, for the phase change can be predicted by the incidental direction and surface orientation. Otherwise the wave spreads in different direction and can not be predicted easily, and the sound field created in this manner is



called diffusive sound field. Using these terminologies we may call the sound field predicted by Kuttruff as diffusive, and the one predicted by Fitzroy as coherent. This thesis tries to develop a simplified model for the reality world – integration of diffusive and coherent sound field.

Besides many numerical techniques to solve sound field problem, two major analytical theories are used to handle the sound field problem with random rough surface: perturbation theory and Kirchhoff theory. Perturbation theory is used for small roughness surface where the scattered field is only slightly altered by the roughness. From this aspect, Kirchhoff is more appropriate for the auditorium setting. The most commonly used Kirchhoff equation to derive scattering coefficient is the following:

$$\psi^{sc}(r) = \frac{-ike^{ikr}}{4\pi r} 2F(\theta_1, \theta_2, \theta_3) \int_{S_M} e^{ik\phi(x_0, y_0)} dx_0 y_0 + \psi_e \quad (6.3)$$

This solution is proved to be appropriate and match the engineering application in estimating the scattering coefficient. However its information granularity is beyond the application in this thesis.

When further assuming that the surface has a Gaussian height distribution and a Gaussian correlation function, the following average intensity is derived by Eckart, Berman and Perkins, etc.:

$$\begin{aligned} \langle I \rangle &= I_0 e^{-g} + \langle I_d \rangle \\ g &= 4R_a^2 = (2k\sigma \cos \theta_1)^2 \end{aligned} \quad (6.4)$$

Notice that  $I$  is the total intensity from a rough surface,  $I_0$  is the energy reflected from a smooth surface and  $I_d$  is the mean intensity of a diffuse field. This equation describes the relative magnitudes of the coherent and diffuse fields.

This equation is derived based on Kirchhoff solution therefore follows all its assumptions as following:

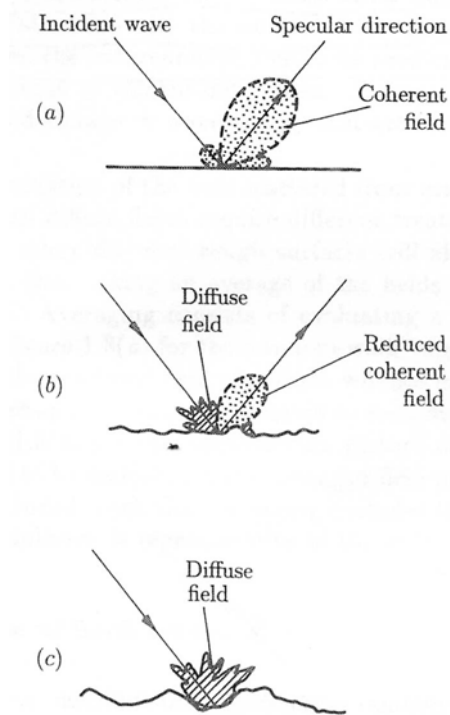
- The incident wave is planar and monochromatic
- No point on the surface has infinite gradient
- Observation is in the far field of the surface
- Valid for approximating the field on the surface of the scatterer
- The reflection coefficient is constant across the surface
- The surface dimensions are much greater than the incident wave length

These assumptions and the surface Gaussian property are quite strict and may not be satisfied in real problem, but it shows that roughly speaking  $e^{-s}$  moderate the proportion between coherent and diffuse sound intensity scattered energy. As  $e^{-s}$  increases, the contribution of coherent sound field increases, and this provides a basis for a speculative template in estimating surface diffusive energy proportion.

#### **6.4 SCATTERING COEFFICIENT ESTIMATION**

Scattering coefficient depends on the incidental angle of the sound wave and detailed geometrical dimensions. It is quite difficult to estimate its value in preliminary design stage. Many practitioners and researchers provided their suggestions to estimate this value based on their experience, yet their recommended values are guided by few theories and sometimes differ from each other significantly (Nijs et al., 2002, Summers, 2002, Gomes and Gerges, 2001, Lam, 1994, Dalenback, 1994, Cox and D'Antonio, 2004). Scale models can be performed to assess the scattering effect in detail, but the relevant time and financial cost makes it difficult. This section will develop a simple method to assess this coefficient.

Rayleigh criterion describes that “roughness” is not only a measure on geometry, but also on wave properties. This measure is  $R_a = k\sigma \cos \theta_1$ , where  $k$  is the wave number,  $\sigma$  is the geometrical measure, and  $\theta_1$  is the incidental angle. The Rayleigh criterion is not accurate, but it qualitatively shows that the same geometrical roughness will result in more scattering for shorter wavelength. (Ogilvy, 1991)



**Figure 6.6. Relevant magnitude of roughness and sound field (Ogilvy, 1991)**

Limited by the information formula scale, this thesis doesn't consider the directional property of the scattering coefficient; rather, it only considers the lump value as the proportion between the non-specular energy and the total reflected energy. Hence in this thesis the scattering coefficient is only related with geometrical property and wave length.

Based on the format of analytical solution, it is speculated that the scattering coefficient for each surface to be defined in the following equation:

$$F = \frac{\text{Diffusive}}{\text{Total}} = 1 - e^{-dk^2\sigma^2} \quad (6.5)$$

It is a simplified  $e^{-g}$  by removing the incidental angle but introducing a new lump parameter  $d$  to compensate this simplification. Since  $d$  is to be calibrated from empirical data, the value of this form is not to provide accurate absolute value, but to provide information on the relative dependency of diffusive proportion on geometrical scale and wave length. How to derive  $d$  will be discussed in Chapter 7.

The following table gives a rough estimate on the magnitude of  $F$  with  $d=2$  (equivalent to incidental angle 45 degree). This may deviate significantly when  $d$  changes, but it generally give a relative magnitude of diffusive proportion changing with geometrical scale and wave length.

**Table 6.4 Estimated diffusive proportion**

Geometrical Roughness (m)	Frequency						
	63Hz	125Hz	250Hz	500Hz	1000Hz	2000Hz	4000Hz
	Wave number						
	1.19	2.38	4.74	9.49	18.98	37.96	75.92
1.2 (audience seat)	0.98	0.99	1	1	1	1	1
0.05	0.01	0.02	0.11	0.36	0.83	1	1
0.03	0.00	0.01	0.04	0.15	0.48	0.93	1
0.01	0.00	0.00	0.00	0.02	0.07	0.25	0.68
0.001	0.00	0.00	0.00	0.00	0.00	0.00	0.01

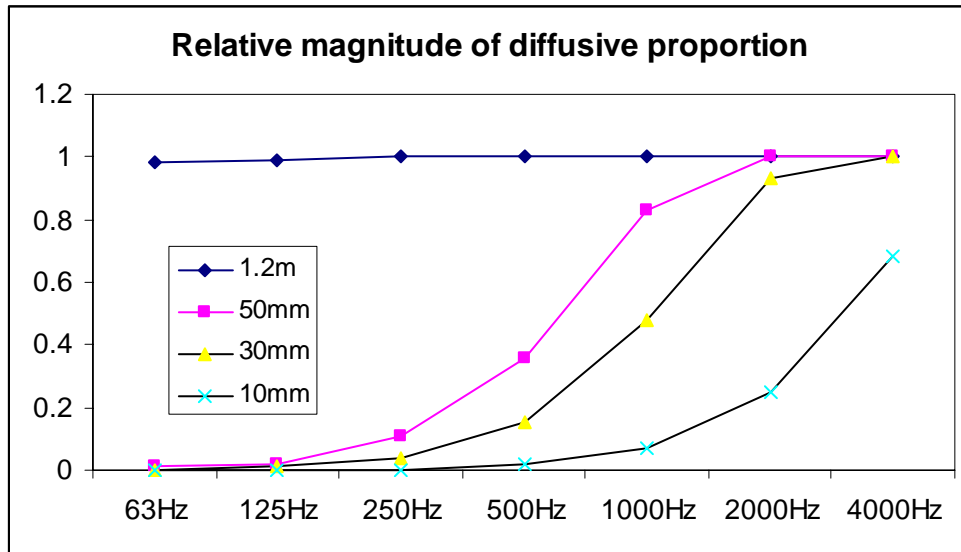


Figure 6.7 Relative magnitude of diffusive proportion

## 6.5 SIMPLIFIED MODEL

Recall that in previous chapter that it is justified to use Kuttruff's and Fitzroy formula for reverberation time prediction in enclosures with completely diffusive and reflective surfaces, corresponding to diffusive and coherent sound field. This thesis will develop a simplified model based on Kuttruff and Fitzroy's equations rather than using any complicated method established by Kirchhoff or other scientific research.

To develop a method to determine the relative distance of the real performance from Kuttruff and Fitzroy's prediction, this thesis considers the question on how to compose the coherent and diffusive sound decaying processes together within the enclosure. Suppose for surface  $i$  the diffusive proportion is  $D_i$  and the absorptive coefficient is  $\alpha_i$ , then it is justified to consider that the equivalent absorptive coefficient participating the coherent decaying process as  $\alpha_i(1-D_i)$ , and the absorptive coefficient

participating the diffusive decaying process as  $\alpha_i D_i$ . After processing each surface through this process, Kuttruff and Fitzroy's formula will be used to compute the equivalent sound absorptive coefficient for the coherent and diffusive sound. Then we speculate the addition of these two coefficients as the total equivalent coefficient.

However, it is noticed that in auditorium the surfaces are not of same  $F$  value. The audience seat area is of the highest irregularity and all other surfaces are of low value comparably. Under this circumstance  $D_i$  is not same as  $F_i$  due to the interaction between opposite surfaces. In Kirchhoff theory, the unstated implied assumption is that the concerned surface is closed and there is no interaction from other surface on coherent or diffusive sound field. Consider two opposite surfaces with property  $F_1$  and  $F_2$  at certain wavelength: if  $F_1=1$  and  $F_2=0$  there will not be a dominant back and forth reflection because their interaction. Therefore the diffusive proportion of one surface, when placed in an enclosed space, will not only determined by its intrinsic property and wavelength, but also will be influenced by its opposite surface property. It would be a very complicated problem if analytically concerned. To construct a simple speculated equivalent diffusive proportion coefficient, the following intuitive aspects are concerned:

- Two surfaces with same  $F$  should yield  $D=F$
- If one surface has property  $F=1$ , then  $D=1$

After trying different speculative forms the following formula is chosen for its simplicity and reasonable match with simulation data.

$$\begin{aligned}
 D_{x1} &= D_{x2} = 1 - (1 - F_{x1})(1 - F_{x2}) \\
 D_{y1} &= D_{y2} = 1 - (1 - F_{y1})(1 - F_{y2}) \\
 D_{z1} &= D_{z2} = 1 - (1 - F_{z1})(1 - F_{z2})
 \end{aligned} \tag{6.6}$$

Hence the equivalent absorptive coefficient is written as

$$\alpha_{eq} = \alpha_c + \alpha_d \quad (6.7)$$

Where  $\alpha_d$  is computed through Kuttruff formula with the surface coefficients  $\alpha_i D_i$ , and  $\alpha_c$  is computed through Fitzroy formula with the surface coefficients  $\alpha_i(1 - D_i)$ .

In summary, this chapter models the influence of scattering effect and non-uniform material distribution on reverberation time with a set of simplified analytical formula.

## CHAPTER 7

### Model Structure

This chapter summarizes the overall reverberation time model based on the discussion in the previous chapters, integrate a scaled evaluation method into this model for engineering practice. To prepare for the model calibration with empirical data, a hierarchical statistical model is developed and a calibration parameter is identified.

#### 7.1 MODEL STRUCTURE

Chapter 4 develops a simplified way to compute free path length variance  $\gamma^2$  to serve as an input parameter in Kuttruff equation. Chapter 5 shows that Kuttruff and Fitzroy's methods are appropriate to estimate the reverberation time of diffusive and coherent sound field separately. Chapter 6 introduced surface diffusivity as a parameter moderating the relative magnitude between the diffusive and coherent sound field, and developed a model to represent this effect.

The overall model structure is summarized in (7.1) to (7.9), where  $S_i, \alpha_i, \sigma_i, F_i$  refers to the area, absorptive coefficient, surface diffusivity magnitude and scattering coefficient of surface  $i$ ,  $D_x, D_y, D_z$  refers to the equivalent scattering coefficient on  $x, y, z$  axis,  $\alpha_x, \alpha_y, \alpha_z$  refers to the equivalent absorptive coefficient on  $x, y, z$  axis, and  $k$  refers to wave number.



The general form (7.1) is justified by the fact that sound decays exponentially in auditorium (Barron and Lee 1988). In (7.1),  $m$  is the air attenuation factor,  $V$  is the volume, and  $S$  is the total surface area,  $\alpha_{eq}$  is the equivalent absorptive coefficient.

Based on the discussion in chapter 6, the equivalent sound absorptive coefficient  $\alpha_{eq}$  is considered as the addition of diffusive part  $\alpha_d$  and coherent part  $\alpha_c$  as described in (7.2). The essential idea in this model is that each surface is considered to contribute to both diffusive and coherent sound field. For any surface  $i$ , the coherent part is  $D_i\alpha_i$ , while the diffusive part is  $1 - D_i\alpha_i$ . The method to compute  $D_i$  is developed through the thesis and described by (7.6) and (7.7) taking the surface diffusivity magnitude as input parameter.

With the absorptive coefficient of each surface separated into diffusive and coherent part, the diffusive sound field absorptive coefficient  $\alpha_d$  is computed by Kuttruff equation (7.3) and (7.4), while the coherent counter part  $\alpha_c$  is computed by Fitzroy equation (7.8).

$$T_{60} = \frac{0.161V}{4mV + \alpha_{eq}S} \quad (7.1)$$

$$\alpha_{eq} = \alpha_d + \alpha_c \quad (7.2)$$

$$\alpha_d = -\ln(1 - \alpha_{mmod}) \left[ 1 + \frac{\gamma^2}{2} \ln(1 - \alpha_{mmod}) \right] \quad (7.3)$$

$$\alpha_{mmod} = \ln\left(\frac{1}{\rho}\right) + \ln\left(1 + \frac{\sum \rho_n (\rho_n - \rho) S_n^2}{\rho^2 S^2 - \sum \rho_n^2 S_n^2}\right) \quad (7.4)$$

$$\rho_i = D_i\alpha_i \quad (7.5)$$

$$\begin{aligned}
D_{x1} = D_{x2} &= 1 - (1 - F_{x1})(1 - F_{x2}) \\
D_{y1} = D_{y2} &= 1 - (1 - F_{y1})(1 - F_{y2}) \\
D_{z1} = D_{z2} &= 1 - (1 - F_{z1})(1 - F_{z2})
\end{aligned} \tag{7.6}$$

$$F_i = 1 - e^{-dk^2\sigma_i^2} \tag{7.7}$$

$$\alpha_c = \frac{1}{\frac{S_x/S}{a_x} + \frac{S_y/S}{a_y} + \frac{S_z/S}{a_z}} \tag{7.8}$$

$$\begin{aligned}
\overline{a_x} &= -\ln(1 - \overline{\alpha_x}) \\
\overline{a_y} &= -\ln(1 - \overline{\alpha_y}) \\
\overline{a_z} &= -\ln(1 - \overline{\alpha_z})
\end{aligned} \tag{7.9}$$

$$\begin{aligned}
\overline{\alpha_x} &= (1 - D_x) \left( \frac{\alpha_{x1} + \alpha_{x2}}{2} \right) \\
\overline{\alpha_y} &= (1 - D_y) \left( \frac{\alpha_{y1} + \alpha_{y2}}{2} \right) \\
\overline{\alpha_z} &= (1 - D_z) \left( \frac{\alpha_{z1} + \alpha_{z2}}{2} \right)
\end{aligned} \tag{7.10}$$

This model requires geometrical measures of the hall defined in chapter 4, assessment of geometrical irregularity, and the sound absorptive coefficients of audience, ceiling, stage, and other enclosing surfaces. The non-demanding geometrical information can be accessed by designers through AutoCAD or simple estimation, and the absorptive coefficients of surrounding materials can be estimated through material property in handbooks.

The limitation of this model is that it does not capture the influence of shape on specula sound field. The relative orientation of surfaces and the resultant effect on reverberation time could be very complicated and stay beyond the scope of this thesis.

## 7.2 SURFACE IRREGULARITY SCALE

In engineering application, especially in preliminary design stage, architects have a flavor on how “rough” the surfaces look like, but accurate information is impossible and unnecessary. A scaled numerical value system without demanding information requirement will be appropriate for this purpose. This thesis uses Hann and Frick’s method to formalize the assessment on surface diffusivity, listed in Table 7.1. Their original criteria is listed in Table 7.2 for reference (Haan and Fricke 1993; Beranek 2004).

The author evaluated the concert halls with pictures and description with this method and acquired consistent ratings with Hann and Frick. This supports the reliability of this method. However it must be pointed out that the scaled assessment method is a rough measure and therefore must be treated with caution.

**Table 7.1 Recommended values for geometrical scale estimation**

Surface	Assessment	$\sigma$ (m)
Ceiling	High	0.1
	Medium	0.05
	Low	0.02
Wall	High	0.05
	Medium	0.03
	Low	0.01
No treatment		0.001
Occupied Floor		1.0

**Table 7.2 Hann and Frick's Assessment Method**

Ceiling	
High diffusivity	Coffered or check-designed with deep recesses or deep beam (larger than 100mm in depth)
	Or random diffusing elements over the full area of ceiling (larger than 50mm in depth or diffusing elements)
	And all with reflective, not sound absorbing materials
Medium diffusivity	Angled array of broken surfaces
	or ornamentally decorative treatment applied with shallow recesses (less than 50mm in depth)
	or array of separate angled reflectors, paneling suspended from the ceiling(less than 5m in depth and covering the full width of the hall)
	or flat concrete surfaces behind the acoustically semi-transparent mesh screen
Low diffusivity	Large separate paneling
	or smoothly curved surface
	or large flat and smooth surface
	or acoustically semi-transparent mesh screen (metal) with large distance (more than 5m) between ceiling and the screen
	or heavy absorptive treatment applied
Walls	
High diffusivity	heavy ornamental design with many pillars, sculptures,etc
	or lattice work with deep recess (deeper than 50mm) and decorations
	or geometrical or random pattern of diffusing elements(covers more than 50% of the wall area)
	and all with reflective not sound absorbing material
Medium diffusivity	indented wall (saw-toothed type) with flat surfaces
	or many balcony fronts of segmented vineyard seating blocks
	or fretwork(framed check type) with recess(less than 50mm in depth)
	or some diffusers applied on the wall (covers more than 20% of the wall area)
	and with mostly reflective materials
Low diffusivity	large separate paneling with shallow recesses
	or smooth with concave surfaces
	or large flat surface
	or heavy absorptive treatment applied

### 7.3 Statistical Model

To make inference for the calibration parameter the relation between observed reverberation time and relevant known parameters needs to be established. A hierarchical statistical model is developed based on the physical model for this purpose. There are two levels of uncertainties in this model: error by measurement and error propagated through the model.

First, the measured reverberation time is considered as a random variable centered at the “true reverberation time”, thus each measurement is a realization of this random variable. Formally it is expressed as  $T_{m60} \sim N(T_{60}, \sigma_m)$ .  $T_{60}$  is considered to be “real” value of reverberation time and  $\sigma_m$  is the measurement variance.

Secondly,  $T_{60}$  itself is a random variable due to the uncertainties propagated through the model by the parameters. In this case the audience and other material absorptive coefficients are the major uncertainty source. It can be described as following:

$$T_{60} = g(d, \tilde{\alpha}), \text{ where } \tilde{\alpha} \text{ is the absorptive coefficients set.} \quad (7.11)$$

Since  $\tilde{\alpha}$  is random vector,  $T_{60}$  is a random variable itself with distribution determined by function form of  $g$  and the distribution of  $\tilde{\alpha}$ .

Thus the statistical model can be heuristically written as the following:

$$T_{m60} \sim N(g(t_{m60} | d, \tilde{\alpha}), \sigma_m) \quad (7.12)$$

This model can be simplified if the distribution of  $t_{m60}$  is known. Since the error of  $t_{m60}$  comes from the parameter uncertainties propagated through the model, Monte-Carlo simulation can be performed to assess its distribution once the parameter uncertainties are elicited. It is reasonable to assume the normal distribution of  $t_{m60}$  for it is evaluated

through Monte-Carlo simulation. Thus the statistical model will be simplified as following. The value of  $\sigma_p$  will be discussed in Chapter 8,

$$T_{m60} \sim N(N(g(t_{m60} | d), \sigma_p), \sigma_m), \text{ where } g \text{ is a random variable.} \quad (7.13)$$

In this model all parameters are known except  $d$ , which will be inferred through empirical data and the established model by statistical method. The parameter inference process is called calibration and will subject to further discussion in next Chapter.

The empirical data used in this thesis comes from Beranek's collection. Owing to their detailed documentary work, the geometrical information, material properties and subjective assessment on surface diffusivity can be obtained quite reliably (Beranek and Hidaka 1998; Beranek 2004).

## **CHAPTER 8**

### **Calibration Method**

Statistical inference is used to draw conclusions from the empirical data, in this thesis, to infer the unknown parameter value based on the established model and observed parameters. There are two fundamental thoughts in making statistical inference: Fisherian and Bayesian. The Fisherian approach is named after Sir Ronald Fisher and combines “frequency approach” (unbiased estimators, hypothesis tests, and confidence levels) with likelihood method. The Bayesian approach is named after Thomas Bayes and founded on the concept of conditional probability. The two and half centuries’ debates on these two approaches are beyond the scope of this thesis and will not be addressed here. Essentially, Bayesians argue that even from Fisherian viewpoint the Bayesian approach possess many advantages, especially its inherent long-run frequency properties. In other word, if computer simulations are used to compare the mean square error, prediction error, converge probability, or power of different procedures, Bayesian method performs better. This substantial practical usability and other advantages justifies Bayesian paradigm (Efron 1986; Leonard and HSU 1999).

The essential idea of Bayesian theorem is to derive posterior distribution of parameters with both prior distribution and empirical observations, and therefore provide a coherent connection between known information and empirical data. Through Bayesian method the parameter identification becomes an open ended inquiry process taking use of accumulation information. Current knowledge is used to assess the initial distribution of parameter, use Bayesian inverse method to acquire posterior

distribution. New data can always be gathered to update and refine this distribution by treating it as new prior distribution. The consistency of Bayesian method is mathematical guaranteed, which means that sequential operation on empirical data will yield same result when feed them at one time (Iversen 1984).

This thesis chooses Bayesian method for the following reasons

- Coherence: it provides a mathematically coherent way to integrate model with empirical data containing uncertainties.
- Expandability: new empirical data after calibration can be easily integrated to generate posterior distribution
- Initial information of parameter can be used

## **8.1 BAYESIAN ANALYSIS**

Modern Bayesian analysis is grounded on Bayes' theorem, which is originally derived by Thomas Bayes to solve the inverse gambling probability problem. It was presented to Royal Society by Richard Price in 1763 after the death of Bayes (Bayesian 1763). Bayesian method finds its wide application in areas ranging from artificial intelligence to evidence based medical technology assessment. It influenced not only statistics, applied science, engineering, design automation but also fundamental philosophy of science (Jefferys and O. 1991; Vick 2002; Bretthorst, 1988).

As a powerful parameter estimation method, Bayesian method has been used to solve problems in acoustics field. There are not many applications in architectural acoustics, but one series of distinct successful researches have used it for reverberation time estimation (Xiang and Goggans, 2001; Xiang et al 2005). Many complexities are introduced in the reverberation time estimation in enclosures, particularly in coupled



spaces measurements, and therefore calls for advanced method to handle uncertainties contained in the information. Bayesian method proves to be a powerful tool to deal with these complexities. As a robust method for parameter inference, Bayesian method is demonstrated as superior to existing nonlinear regression approach. It is also used to perform model comparison and selection under complicated problem settings (Xiang, 2001; Xiang et al, 2005).

This thesis will use Bayesian method as a parameter inference technique to solve the problem defined in the previous chapter. It will be used to calibrate one parameter in the model with empirical data which contains complicated uncertainty structures.

Bayesian theorem reads as following: suppose that  $X$  is a random variable with parameter  $\theta$ , then given the prior distribution of  $\theta$  and observation on the realization of  $X$ , the posterior, or conditional distribution according to Bayesian is the following:

$$\pi(\theta | x) = \frac{f(x | \theta)\pi(\theta)}{\int f(x | \theta)\pi(\theta)d\theta} \quad (8.1)$$

Under the context of this thesis, the observed variable is reverberation time, and the variable of interest is  $d$ . Their relation is structured through the hierarchical statistical model developed in section 7.2.

Therefore the Bayesian distribution of calibration set would be the following

$$\pi(d | T_{m60}) = \frac{g(T_{m60} | d)\pi(d)}{\int g(T_{m60} | d)\pi(d)dd} \quad (8.2)$$

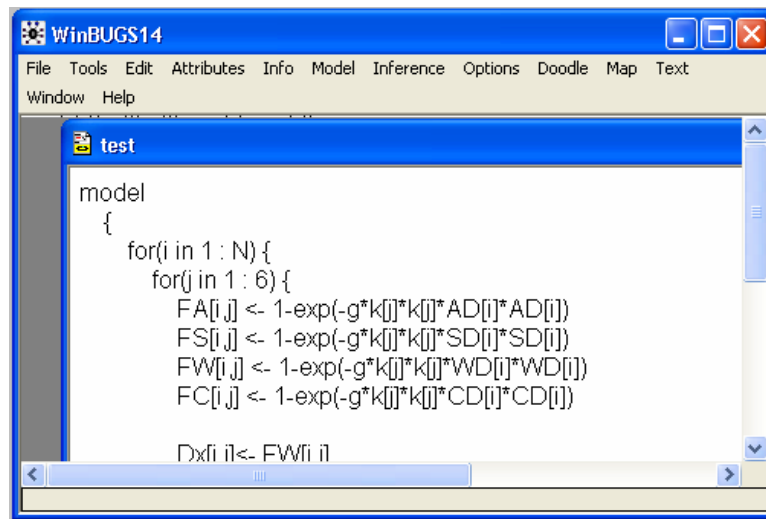
To use this model to perform Bayesian inference, the following information is needed and will be elicited in the next chapter:

- Variance of measurement
- Distribution of reverberation time propagated through the model
- Initial assessment on distribution of the calibration parameter

## **8.2 SOFTWARE TOOL**

The implementation of Bayesian inference can be a challenging problem. As the classical statistics relies on optimization of the least square loss or other criteria, the Bayesian statistics relies on integration as shown in its format. The introduction of Markov Chain Monte Carlo (MCMC) method makes the solution possible for general and practical application (Robert 2001; Vidakovic 2004). Different MCMC algorithms are useful for different situations, among them the most popular methods are Gibbs sampler and the Metropolis–Hastings sampler. Comparing with the vintage of M-H method, the Gibbs sampling method is contemporarily developed and is especially appropriate when the conditional distribution is easy to sample.

This thesis will use WINBUGS (Bayesian inference Using Gibbs Sampling) to implement Bayesian inference. It is part of the BUGS project to make the MCMC methods available to applied statisticians. To make inference with WinBUGS, users need to write code in text or represent it through the DOODLE tool, and assign or generate initial distribution. The detailed posterior distribution information will be provided by the software through the updating process (BUGs).



**Figure 8. 1 WinBUGS Text coding Interface**

## CHAPTER 9

### Parameter Value and Uncertainty Assessment

This chapter elicits the measurement error, reverberation time prediction error propagated through the model, and parameter initial distribution. This information will be used for Bayesian calibration in next Chapter.

#### 9.1 MEASUREMENT ERROR

The empirical data to be used in this thesis comes from Beranek's data collection on 100 music halls (Beranek 2004). As shown in Table 9.1, the measurement data may come from different groups.

**Table 9.1 Empirical Measurement Data Format (Beranek, 2004)**

Example: Boston Symphony Hall occupied Reverberation Time							
Measured by	Year of data	125	250	500	1000	2000	4000
Hidaka/Beranek	1992	1.8	1.9	1.8	1.8	1.7	1.4
Griesinger/Kirkegaard	1993	2.1	1.8	1.9	1.9	1.6	1.2
Beranek	1997	1.95	1.9	1.9	1.95	1.59	1.43

Since there are multiple measurement data for one hall performed by different groups, the easiest way to assess the variance is to directly compute the standard deviation of the dataset and use it as the measurement variance. Obviously the more measurement sets, the more reliable this variance estimation is, and the problem with this approach is that there are two few dataset for this purpose. Among the 100 halls only 2

come with more than 2 measurements on occupied situation. Therefore the assessment on the measurement will mainly count on the literature survey result discussed in the following.

### **9.1.1 Measurement error at one specific location**

This section discusses the measurement uncertainty at one specific location. If we examine the measurement method, we know that the measurement equipments are composed of sound source, receiver and data processing unit (sound meter may integrate both receiver and processing unit). Usually pink noise or other type of sound is produced by the source generator, and the data processing unit process the signal received from the microphone and compute the reverberation time. The following factors have to be considered in assess the measurement uncertainty (Pelorson, Vian et al. 1992):

- Repeating measurements
- Small variance of source-microphone positions
- Different type of microphones
- Different type of loudspeakers

Pelorson et al systematically examined these measurements errors. The following tables are supplied according to Pelorson’s data.

**Table 9.2 Measurement error for 6 repetitive measurements**

	125Hz	250Hz	500Hz	1000Hz	2000Hz	4000Hz
RT STD	0.05	0.02	0.04	0.02	0.02	0.01

**Table 9.3 Measurement error for 30cm variation of source-microphone position**

	125Hz	250Hz	500Hz	1000Hz	2000Hz	4000Hz
RT STD	0.08	0.05	0.08	0.11	0.08	0.06

As for the different types of microphones and loudspeakers, Pelorson reported ignorable deviation for microphone type Neuman’s studio TLM 170i and Bruel& Kjaer’s ½ inch 4155, and ignorable deviation for two classical loudspeakers and one dodecahedron loudspeaker.

In another study on measurement error, Lundeby investigated the influence of different “omni-directional” sources rotated stepwise by 20 degree (Lundeby and Vigran 1999). The result shows the standard deviation is as following tables. The error is slightly larger than Pelorson’s study and generally the magnitude scale matches.

**Table 9.4 Measurement error for Dodecahedron 45cm with stepwise rotation**

	125Hz	1000Hz	4000Hz
RT STD (s)	0.02	0.01	0.02

**Table 9.5 Measurement error for Cube 16cm Edge with stepwise rotation**

	125Hz	1000Hz	4000Hz
RT STD (s)	0.02	0.01	0.01

These studies show that the standard deviation at one specific point is about 4-6% in general and the influence of equipments are of smaller scale in comparison with the position variance of microphones.

### ***9.1.2 Overall measurement error assessment***

Bork provides estimation on the standard deviation for an average measurement value for one specific team (Bork 2002).

**Table 9.6 Measurement Error Estimation**

	125Hz	1000Hz	4000Hz
RT STD (s)	0.05	0.04	0.02

This estimation is slightly optimistic compared to the study in 8.1.1, but the general magnitude does not differ much. A further and much more important question for this

thesis is not the self estimation for any single experiment; rather, we have to assess the overall measurement error when measurements are performed by different teams.

Lundeby and Vigran studied this problem by letting 7 teams measuring the RT and EDT for the same hall. These teams used their own equipments and reported one average frequency dependent value. The following table summarizes the STD for these team dependent measurements.(Lundeby and Vigran 1999)

**Table 9.7 Measurement error of seven teams with different equipments**

	Low	Mid	High
RT STD (s)	0.08	0.06	0.10

This data is consistent with the previous research, and will serve as a basis for this thesis to estimate the measurement error of the measurements. Formally we state it as following:

$$\sigma_m = 0.08s \text{ for frequency } 125\text{Hz and } 250\text{Hz}$$

$$\sigma_m = 0.06s \text{ for frequency } 500\text{Hz and } 1000\text{Hz}$$

$$\sigma_m = 0.1s \text{ for frequency } 500\text{Hz and } 1000\text{Hz}$$

## 9.2 MATERIAL PROPERTY UNCERTAINTY

In this model the reverberation time prediction uncertainty comes from the propagation of parameter uncertainties, especially the absorptive coefficients.

Since the audience absorption in occupied hall account for 75%-85% overall absorption (Beranek and Hidaka 1998), it is necessary to first investigate the method to assess the audience absorption coefficients and its reliability.

As discussed earlier in Chapter 3, two standard methods to measure the material absorption coefficients are tube method and reverberation chamber method. The audience

absorption measurement is usually performed in reverberation chamber. Besides the necessary common consideration in edge effect and diffusivity in the reverberation chamber, the difficulty in measuring audience absorption coefficient lies in the following aspects:

- The seat details are different in different concert hall, but in general it can only be classified into limited categories for the incomplete information in early stage.
- Audience clothing is an important absorption source, but it changes with season, culture and fashion
- To represent the audience area with a block of seats is still not fully justified

Research has been performed to disclose the relation between the absorptive coefficient and chair & clothes (Kirkegaard, 1996). For rougher estimation, although subject to all theoretical criticism, it is reported that Kahn and Kuhl's measurement method have quite good match with empirical data. When the seating details are unknown, Kahn and Kuhl supplied estimation data for audience absorption, listed in Table 9.8. This is the most frequently quoted table to estimate the audience absorption. It is to be noticed that this table is to be used with the consideration of "edge effect", i.e., its area should be compensated by adding a strip of "wavelength/8", which corresponds to 0.3m – 0.01m depending from frequency 125 to 4000Hz, as listed in Table 9.9.

Beranek provided two useful values to estimate the floor areas: floor space  $S_a$  and acoustical audience area  $S_A$ . The acoustical audience area  $S_A$  includes  $S_a$  and a 0.5m strip around the separated blocks of the seating area, except that such strips are neither included at the front edge of a balcony where the audience is seated against a balcony rail



nor where the seats abut a wall. These values are useful for this thesis to determine the effective areas for Kahn and Kuhl's method:  $S_{floor} = S_a + Strip/0.5 * (S_A - S_a)$ , where strip is the width listed in Table 9.9. (Kuttruff 1999)

**Table 9.8 Audience absorption coefficient by Kahn and Kuhl**

Seats	125	250	500	1000	2000	4000
Audience on wooden chairs (2person/m <sup>2</sup> )	.24	.40	.78	.98	.96	.87
Audience on upholstered seats	.72	.82	.91	.93	.94	.87

**Table 9.9 Strip width to compensate the edge effect**

	125	250	500	1000	2000	4000
Strip (m)	.3	.15	.08	.04	.02	.01

Another frequently quoted data is derived from site measurement data by Beranek et al (Beranek, 1998). Its rationale is to derive the audience sound absorption through the empty (before seat is installed) and occupied hall reverberation data. It is similar with the lab measurement method but less rigorous because the concert hall is not controlled diffusive sound field. Hence although this group of data has its value for empirical appropriateness, it differs from Sabine absorptive coefficient.

Table 9.10 listed the derived standard deviation for audience absorptive coefficients to estimate its uncertainty.

**Table 9.10 Standard deviation of audience absorptive coefficients**

Type	Frequency (Hz)					
	125	250	500	1000	2000	4000
Audience on wooden chairs	0.05	0.09	0.13	0.17	0.09	0.05
Audience on upholstered seats	0.14	0.11	0.05	0.04	0.03	0.01

To estimate the other material absorption in a given concert hall is another difficult problem. As discussed earlier in Chapter 3, the material absorption is determined not only by material nature or acoustic impedance, but also by the boundary condition. Although Beranek's book provide quite detailed information on material assignment, without geometrical information on its thickness and neighboring material information it is unrealistic to estimate the actual absorptive coefficients. Nevertheless, as the research by Beranek shows, the absorptive coefficients of empty existing halls fall roughly into two categories: halls lined with light material and heavy material. Their absorptive coefficients are estimated in Table 9.11.

**Table 9.11 Absorptive coefficient without audience  
(Beranek and Hidaka 1998)**

Name of hall	Frequency (Hz)					
	125	250	500	1000	2000	4000
Halls with heavy material						
Kanangawa, Chamber Hall	.17	.14	.11	.08	.08	.07
Boston, Symphony Hall	.17	.14	.11	.09	.09	.08
Tokyo, TOC concert Hall	.14	.12	.09	.09	.08	.06
Tokyo, Hamaryku-Asahi Hall	.16	.14	.11	.10	.09	.07

**Table 9.11 (Cont.) Absorptive coefficient without audience  
(Beranek and Hidaka 1998)**

NY Avery Fisher Hall	.15	.11	.07	.06	.07	.06
Seattle, Opera House	.15	.12	.10	.10	.11	.11
Average	.16	.13	.10	.09	.08	.08
Halls with light material						
Mitaka, City Concert hall	.13	.10	.08	.07	.07	.08
Nantes Concert Hall	.12	.11	.09	.09	.09	.08
NY Philharmonic Hall	.11	.09	.08	.08	.08	.08
Average	.12	.10	.08	.08	.08	.08

This thesis will utilize this table to estimate the material absorptive coefficients other than audience. It is to be pointed out that the material absorptive coefficients can be quite accurately estimated with the information on its property and geometrical dimensions in reality.

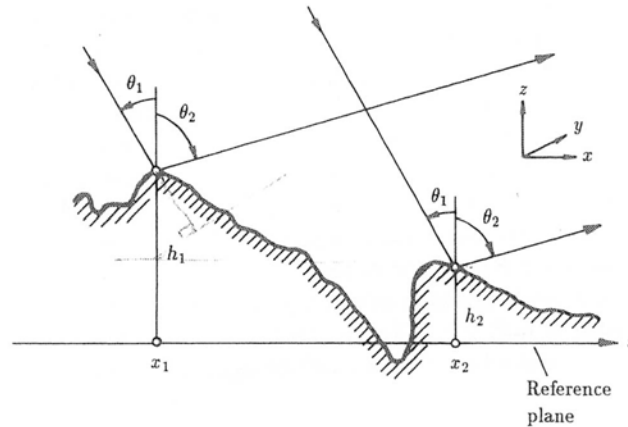
The variance of material absorptive coefficients can be estimated and listed in Table 9.12.

**Table 9.12 Standard deviation of material absorptive coefficients**

Type	Frequency (Hz)					
	125	250	500	1000	2000	4000
Halls with heavy material	0.012	0.013	0.016	0.015	0.013	0.018
Halls with light material	0.010	0.010	0.005	0.010	0.010	0.000

### 9.3 INITIAL DISTRIBUTION OF $d$

As described earlier in chapter 6, in the original formula,  $d = (\cos \theta_1 + \cos \theta_2)^2$ , where  $\theta_1$  and  $\theta_2$  are illustrated in Figure 9. 1.



**Figure 9. 1 Illustration of scattering effect (Ogilvy, 1991)**

Since both  $\theta_1$  and  $\theta_2$  can be anywhere between 0 to  $\frac{\pi}{2}$ , the minimum and maximum value of  $d$  is 0 and 4 separately. This thesis uses the uniform distribution for  $d$  as initial distribution.

$$d \sim \text{Uniform}(0,4)$$

Along with other information structured in this chapter, this distribution of  $d$  will be used to make inference for model calibration in the next chapter.

## CHAPTER 10

### Model Calibration and Validation

This chapter will use the empirical measurement data to infer the posterior distribution for parameter  $d$  with WinBUGS. The parameter distributions elicited in the previous chapter are used, and the program written in the WinBUGS syntax is attached as appendix.

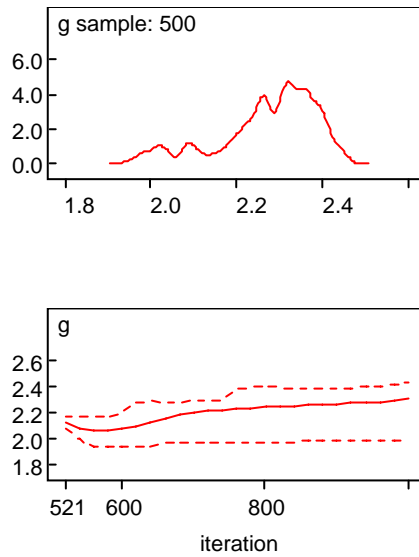
#### 10.1 MODEL CALIBRATION

Table 10.1 listed some brief technical parameters to be used for calibration purpose. The measurement data on octave frequencies supplied by Beranek's data is used. More detailed technical information is listed in the Appendix.

**Table 10.1 Halls used for calibration purpose**

Name	Volume (m <sup>3</sup> )	S (m <sup>2</sup> )
BOSTON Symphony Hall	18750	1370
New York Avery Fisher Hall	20400	1480
Baltimore, Joseph Meyerhoff Symphony Hall	21530	1487
Amsterdam, Concertgebouw	18780	1125

By operating the WinBUGS program and the corresponding dataset, the posterior distribution is inferred. The detailed data is attached as Appendix. The following shows the calibration result for parameter  $d$ .

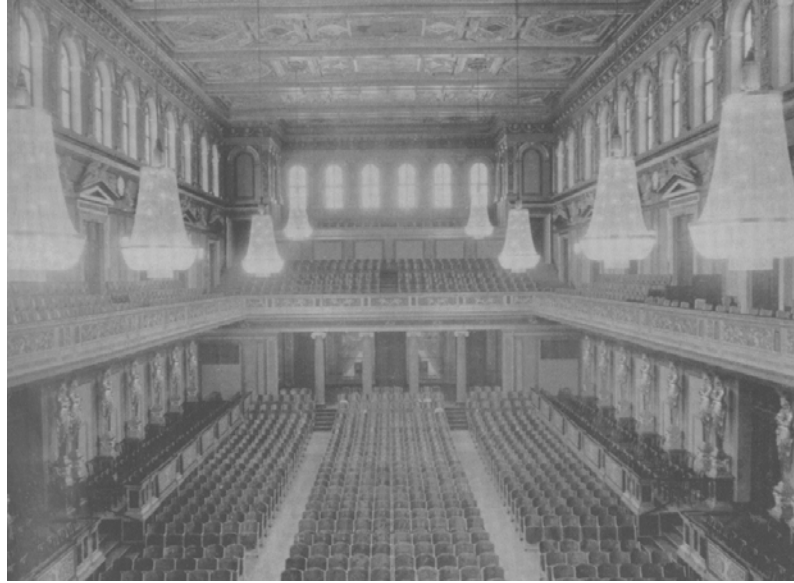


**Figure 10.1 Calibration Result inferred from WinBUGS**

The best estimator for  $d$  is 2.3, with a standard deviation of 0.11. Thus the model developed in this thesis is completed.

## 10.2 VALIDATION

This section validate the model by comparing the measurement data against the prediction of this method, along with Sabine, Kuttruff and Fitzroy's formula. This thesis uses Grosser Musikvereinssaal Hall as a case for model validation. It is one of the greatest hall in the world. As Beranek commented, "Without doubt, the pulse of any orchestra conductor quickens when he first conducts in this renowned hall. The Vienna Philharmonic, the parade of famous conductors, and the fine music played there make this the Mecca of the old halls of Europe."



**Figure 10.2** Grosser Musikvereinssaal, Vienna (Beranek, 2004)

Figure 10.3 and Table 10.1 shows the comparison between model predictions and measurements. It suggests that in general it is not appropriate to use Fitzroy's method. For high frequency Kuttruff equation performs quite well and for low frequency Arau-Puchades performs quite well.

Compute the deviation between measurements and predictions with

$$\sum_{octave} (T_m - T_p)^2$$

Where  $T_m$  is the measurement and  $T_p$  is the prediction value.

The results are listed in the last row of Table 10.1. It is shown that this model performs better than all the other methods.

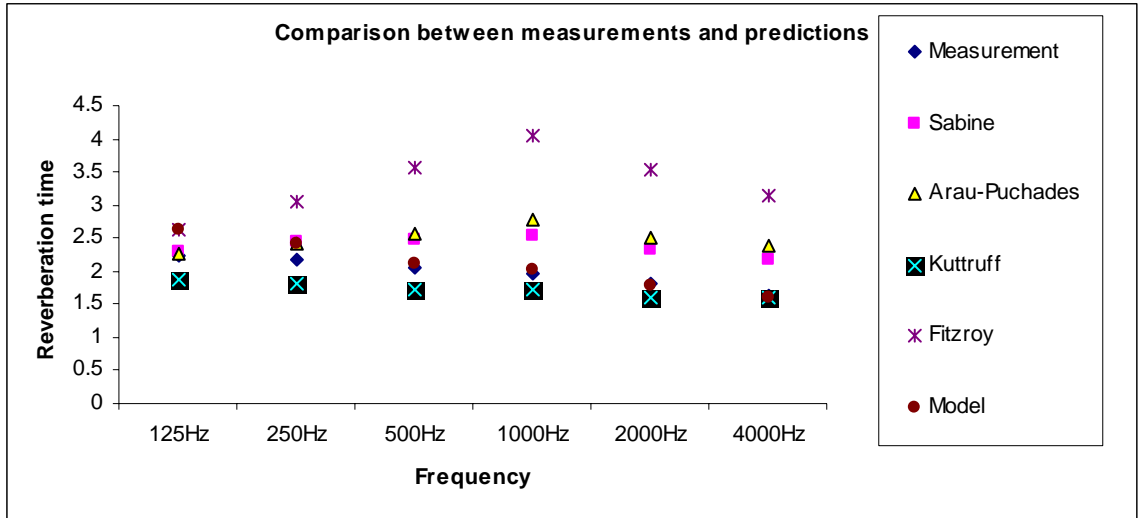


Figure 10.3 Comparison between measurements and predictions

Table 10.2 Comparison between measurements and predictions

Frequency	Measurement	Sabine	Arau-Puchades	Kuttruff	Fitzroy	Model
125Hz	2.25	2.31	2.25	1.86	2.62	2.64
250Hz	2.18	2.44	2.42	1.80	3.05	2.42
500Hz	2.04	2.46	2.58	1.71	3.57	2.12
1000Hz	1.96	2.53	2.79	1.72	4.06	2.01
2000Hz	1.8	2.33	2.52	1.60	3.53	1.78
4000Hz	1.62	2.19	2.38	1.60	3.15	1.61
Deviation		1.18	2.13	0.51	12.98	0.22



# **CHAPTER 11**

## **Conclusion**

### **11.1 SUMMARY**

This thesis develops a semi-empirical reverberation time prediction model by two steps. First, a simplified model is developed to integrate shape, scattering effect and non-uniform material distribution factors through literature survey, analytical studies, and simulation experiments. Second, this model is calibrated with empirical data to further enhance its accuracy. Due to the complicate uncertainties contained in the empirical data, this thesis build a statistical hierarchical model and uses Bayesian method to perform parameter estimation and ensure the coherence between theory and data.

One important concern through the model development is that the input parameters should be accessible for the preliminary design stage. This model recognizes and uses the following parameter metric:

{Maximum length, Maximum Width, Maximum Height, Maximum Diagonal Length of Plan, Volume, Surface Area, Floor Area, Stage Area, Audience Seat Type, Scaled Rating for Surfaces (high, medium and low), Material Absorption}

### **11.2 CONTRIBUTION**

This thesis consciously structure the model in such a way to integrate significant effects with input parameters accessible in preliminary design stage. First, the influence of geometrical shape is represented in a manner such that no detailed information is required. Secondly, the influence of surface diffusivity/ interior decoration style is

studied, and a simple estimation method is developed based on earlier work by Kuttruff, Arau-Puchades, Fitzroy and other researchers. Through this model designers will be able to manipulate the parameters and observe their influences on reverberation time, thus to make better informed decisions.

Its advantage in comparison with typical acoustical simulation software is that it does not demand complete knowledge in geometrical representations and detailed information. It is a simple tool to support preliminary design stage.

In comparison with traditional formula, it provides more accurate predictions by taking use of more design information. It reflects the influence of geometrical shape, non-uniform material distribution and scattering effects. This thesis particularly brings awareness on the influence of scattering effect on reverberation time by demonstrating the significant discrepancy among the predictions of Kuttruff, Arau-Puchades, and Fitzroy's formula.

Since this model contains no mathematical complexity and is very easy to be implemented, it can also be extended to develop simulation or optimization modules for building total performance software.

From the methodology perspective, this thesis uses Bayesian rather than traditional regression method to achieve the coherence between theoretical knowledge and empirical data. The parameter uncertainties analysis addresses the issue on how much useful information can we possibly acquire from a collection of data measured by different groups. Through the model calibration process, this thesis shows that Bayesian method is an effective way to link theory and data. As Bayesian method (Xiang and Goggans, 2001, Xiang et al, 2005, Jasa et al, 2005) has been successfully applied for parameter estimation

and model selection for complicated problem in architectural acoustics, its effective application in this thesis on a different problem will help bring further awareness of research community toward this advanced technique.

### **11.3 LIMITATION**

Although this model performs better in comparison with existing simplified models, it did not capture all significant relationships and therefore did not take use of all available information in preliminary design stage.

The most significant relationship the model fails to capture is the influence on reverberation time caused by relative orientations of reflective surfaces. As the model developed in this thesis is based on existing equations for enclosures with reflective and diffusive surfaces, it has been noticed through the study that none of the existing equations accurately predict reverberation time for enclosures with reflective surfaces. To develop a model for accurate prediction for enclosures with specular surfaces, some geometrical measures on relative orientations of surfaces must be included, especially when material absorption is not uniformly distributed. Since the indirect influence of audience absorption caused by its reflection with neighboring surfaces has been observed as a significant factor in practice (Kirkegaard, 2005), to further explore the relative surface orientations beyond the pair-up concept or justify the pair-up concept is a necessary task for further study.

Second, the integration of scaled measure into the model is to increase the simplicity of the model, but the simplicity may result in unnecessary loss of information. Users should be aware of this effect and use it only for rough estimation to avoid potential danger.

Another limitation of this thesis is that no coupled room effect is considered. As addressed in research literature, both the reverberation time predictions and measurements of coupled room contains much more mathematical complexity. (Marshall and Kirkegaard, 1993; Kirkegaard, 1993; Xiang et al., 2005). The geometrical shape representation in this thesis only applies to auditoriums without considering coupled room effects. To develop a reasonable simplified model is a challenging but necessary task.

#### **11.4 FUTURE WORK**

First, a deeper analytical study should be performed to understand the relationship between surfaces orientations and reverberation time for enclosures with reflective surfaces. This problem is much more complicated than enclosures with diffusive surfaces, which has been considered as solved by Kuttruff through the introduction of free path length variance as a parameter. The author hopes that application of probability theory may help structure an analytical solution and use it as a basis for further investigation. Although computer simulation can easily do prediction for arbitrary shapes, the author insist that analytical studies will help developing further understanding in the relationship between reverberation time and geometrical characteristics. Furthermore, the insights developed through analytical study may lead to simplification of computer simulation algorithm.

Secondly, the interaction between non-uniform material distribution and scattering effect can be further explored through scale model experimental studies.

## APPENDIX A

### Coleman's Formula (Coleman, 1981)

Given rectangle with  $x < y < z$

$$Y = 6xyz\pi, L = x + y + z$$

$$r = x^2y^2 + y^2z^2 + x^2z^2$$

$$w = (x^2 + y^2 + z^2)^{1/2}$$

$$v_x = (y^2 + z^2)^{1/2}, v_y = (z^2 + x^2)^{1/2}, v_z = (y^2 + x^2)^{1/2}$$

$$G(\mu; \eta) = 4(\mu^2 - \eta^2)^{1/2}(2\mu^2 + \eta^2)$$

$$T(\mu; \kappa, \eta) = 12xyz\left(\kappa \arctan\left(\frac{(\mu^2 - v_x^2)^{1/2}}{\eta}\right) + \eta \arctan\left(\frac{(\mu^2 - v_x^2)^{1/2}}{\kappa}\right)\right)$$

The distribution of  $l$  is as following ( $x \leq y \leq z$ )

$-9l^4 + 8Ll^3$	$0 < l \leq x$
$xY - x^4 + 8(y+z)l^3 - (y+z)G(l;x)$	$x < l \leq y$
$(x+y)Y - (x^4 + y^4) + 9l^4 + 8zl^3 - (y+z)G(l;x) - (x+z)G(l;y)$	
$y < l \leq \min(z, v_z)$	
$LY - (x^4 + y^4 + z^4) + 18l^4 - \{(y+z)G(l;x) + (x+z)G(l;y) + (x+y)G(l;z)\}$	$z < l \leq v_z$
$(x+y)Y - 6x^2y^2 + 8z^3 + z\{G(l;v_z) - G(l;x) - G(l;y)\} - (x+y)G(l;z) - T(l;x,y)$	$v_z < l \leq z$
$LY - z^4 - 6x^2y^2 + 9l^4 + z\{G(l;v_z) - G(l;x) - G(l;y)\} - (x+y)G(l;z) - T(l;x,y)$	$\max(z, v_z) < l \leq v_y$
$LY + x^4 - 6x^2v_x^2 + yG(l;v_y) + zG(l;v_z) - yG(l;z) - zG(l;y) - T(l;x,y) - T(l;x,z)$	$v_y < l \leq v_x$
$LY + w^4 - 8r - 9l^4 + xG(l;v_x) + yG(l;v_y) + zG(l;v_z) - T(l;x,y) - T(l;x,z) - T(l;y,z)$	$v_x < l \leq w$
$0$	<i>otherwise</i>

The analytical solution for the second moment of the distribution can be written as following:

$$E_\mu X^2 = \frac{F_{-1}}{1.5\pi S}$$

$$F_{-1} = F_{-1}(x; y, z) + F_{-1}(y; z, x) + F_{-1}(z; x, y)$$

$$F_{-1}(x; y, z) = (x^3 - 6\pi V)x \ln x + (8y^2z^2 - v_x^4) \ln v_x + \frac{1}{3}(w^4 - 8r + 6\pi VL) \ln w +$$

$$4\{yz^3 \arctan\left(\frac{y}{z}\right) + zy^3 \arctan\left(\frac{z}{y}\right)\} - 4xv_x^3 \arcsin\left(\frac{x}{w}\right) - T_{-1}(x; y, z)$$

$$T_{-1}(x; y, z) = \int_{v_x}^w \frac{T(x; y, z)}{x} dx$$

$$E_\mu X = \frac{4V}{S}$$

$$\gamma^2 = \frac{E_\mu X^2}{(E_\mu X)^2} - 1$$

## APPENDIX B

### Technical Descriptions of Grosser Musikvereinssaal Hall

The side walls are made irregular by over forty high windows, twenty doors above the balcony, and thirty-two tall, gilded buxom female statues beneath the balcony. Everywhere are gilt, ornamentation, and statuette. Less than 15% of the interior surfaces is made of wood. Wood is used only for the doors, for some paneling around the stage, and for trim. The other surfaces are plaster on brick or, on the ceiling and balcony fronts, plaster on wood lath (Beranek, 1995).

**Table B.1 Technical Parameters of Grosser Musikvereinssaal Hall  
(Beranek, 2004)**

<b>Parameter</b>	<b>Description</b>
Ceiling	Plaster on spruce wood
Side and rear wall	Plaster on brick, except around the stage, where walls are of wood; doors are of wood; balcony fronts are plaster on wood
Floors	Wood
Carpets	None
Stage floor	Wood risers over wood stage
Stage height	39 inches above floor level
Added absorbing material	200 ft <sup>2</sup> of draperies over front railings on side loges
Seating	Wood structure on main floor and side balconies, except that tops of seat bottoms are upholstered with 4 inches of cushion covered by porous cloth; rear balcony seats, plywood
Architect	Theophil Ritter von Hansen
Opening year	1870
Volume	15000m <sup>3</sup>
Area of floor over which the audience chairs are located	690m <sup>2</sup>
Acoustical audience area	955m <sup>2</sup>
Area of stage	163m <sup>2</sup>
Seats number	1680
Height	17.4m
Width	19.8m
Length	35.7m

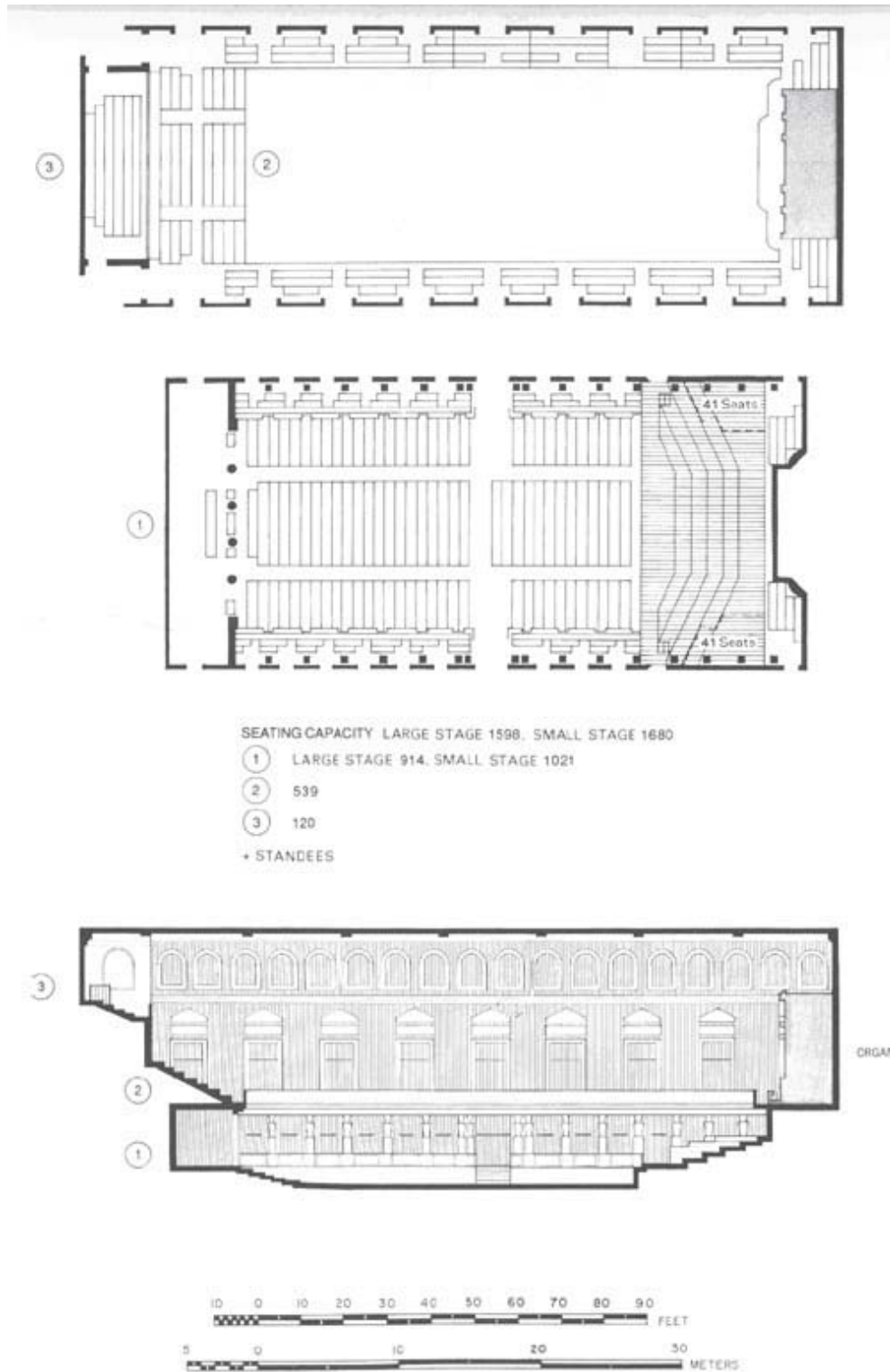


Figure B.1 Plan Drawings of Grosser Musikvereinsaal Hall (Beranek, 2004)

## References

- Abdou, A. A. (2003) Comparison of the acoustical performance of mosque geometry using computer model studies, Vol. Eindhoven, Netherlands.
- Abdou, A. A. (2003) Measurement of acoustical characteristics of mosques in Saudi Arabia. *Journal of Acoustical Society of America*, **113**, 1505-1517.
- Acentech (1998) Acoustical observations and recommendations: Robert Ferst Center for the Arts, Vol. Acentech Incorporate.
- Allen, J. B., Kirkegaard, R. L. and Puria, S. (1993) Minimally intrusive occupied hall measurement techniques. *Journal of Acoustical Society of America*, **93**, 2357.
- Ando, Y. (1985) *Concert hall acoustics*, Springer-Verlag.
- Ando, Y. (1998) *Architectural Acoustics: Blending sound sources, sound fields and listeners*, Springer.
- Ando, Y. and Noson, D. (Eds.) (1997) *Music and Concert Hall Acoustics*, Academic Press.
- Antonio, J. and Godinho, A. T. (2002) Reverberation times obtained using a numerical model versus those given by simplified formulas and measurements. *Acta Acustica United with Acustica*, **88**.
- Arau-Pachades, H. (1988) An improved reverberation formula. *Acustica*, **65**, 163-179.
- ASTM (1990) ASTM C423-90a, Vol. American Society for Testing and Materials Standard.
- Barron, M. (1988) Subjective study of British Symphony Concert Halls. *Acustica*, **66**.
- Barron, M. (1993) *Auditorium acoustics and architectural design*, E&FN SPON.
- Barron, M. and Lee, L.-J. (1988) Energy relations in concert auditoriums. *Journal of Acoustical Society of America*, **84**, 618.
- Behler, G. K. (2002) Uncertainties of measured parameters in room acoustics caused by the directivity of source and/or receiver, Vol.
- Benedetto, G. and Spagnolo, R. (1984) Statistical distribution of free path lengths in the acoustics of enclosures. *Journal of Acoustical Society of America*, **75**, 1519.
- Beranek (2004) *Concert halls and opera houses: music, acoustics and architecture*, Springer-Verlag.
- Beranek, L. L. (1962) *Music, Acoustics, and Architecture*, John Wiley & Sons.
- Beranek, L. L. and Hidaka, T. (1998) Sound absorption in concert halls by seats, occupied and unoccupied, and by the hall's interior surfaces. *Journal of Acoustical Society of America*, **104**, 3169.
- Beyer, R. (1999) *Sounds of Our Times, Two Hundred years of Acoustics*.
- Bies, D. A. and Hansen, C. H. (1996) *Engineering Noise Control: Theory and Practice*,



E&FN Spon.

- Bistafa, S. R. and Bradley, J. S. (2001) Predicting speech metrics in a simulated classroom with varied sound absorption. *Journal of Acoustical Society of America*, **109**, 1474-1482.
- Borish, J. and Angell, J. B. (1983) An efficient algorithm for measuring the impulse response using pseudorandom noise. *Journal of Audio Engineering Society*, **31**.
- Bork, I. (2002) Simulation and measurement of auditorium acoustics - the round robins on room acoustical simulation, Vol. 24.
- Bradley, J. S. (1986) Speech intelligibility studies in classrooms. *Journal of Acoustical Society of America*, **80**.
- Bradley, J. S. (1986) Predictors of speech intelligibility in rooms. *Journal of Acoustical Society of America*, **80**.
- Bradley, J. S. (1991) A comparison of three classical concert halls. *Journal of Acoustical Society of America*, **89**, 1176-1192.
- Bradley, J. S. (1992) Predicting theater chair absorption from reverberation chamber measurements. *Journal of Acoustical Society of America*, **91**, 1514-1524.
- Bradley, J. S. (1992) Predicting theater chair absorption from reverberation chamber measurements. *Journal of Acoustical Society of America*, **91**, 1514-1524.
- Bradley, J. S. (1995) On the effect of the audience on auditorium acoustics, Vol. Trondheim, Norway.
- Bretthorst, L. (1988) *Bayesian spectrum analysis and parameter estimation*, Springer-Verlag, New York.
- Brooks, C. N. (2003) *Architectural Acoustics*, McFarland Company.
- Calamia, P. T. and Pfeiffer, S. (1999) Effect of closely spaced high-frequency reflections on perception of music. *Journal of Acoustical Society of America*, **105**, 1046.
- Chiang, W. (1994) Effects of Various architectural parameters on six room acoustical measures in auditoria, Vol. University of Florida.
- Chu, W. T. (1990) Impulse response and reverberation decay measurements made by using a periodic pseudorandom sequence. *Applied Acoustics*, **29**.
- CIB (1982) CIB publication 64. Working with the Performance Based Approach in Building, Vol.
- Citherlet, S. and Hand, J. (2001) A method for multiple view assessment of building performance in esp-r, Vol. Rio de Janeiro, Brazil.
- Clements, P. (2001) The acoustic design of the Concertgebouw, Amsterdam and resolution of the hall's early acoustical problems. *Journal of Acoustical Society of America*, **109**.
- Coleman, R. (1981) Intercept lengths of random probes through boxes. *Journal of Applied Probability*, **18**, 276-282.

- Conway, C. and Corcoran, D. (2002) An evolutionary approach to acoustic modeling, Vol.
- Cowan, J. (2000) *Architectural Acoustics Design Guide*, McGraw Hill.
- Cox, T. J. and D'Antonio, P. (2003) Engineering Art: the science of concert hall acoustics. *Interdisciplinary science reviews*, **28**.
- Cox, T. J. and D'Antonio, P. (2004) *Acoustic absorbers and diffusers - theory, design and application*, Spon Press.
- Cremer, L. and Muller, H. (1982) *Principles and applications of room acoustics*, Applied Science Publisher, London and New York.
- Cybenko, G. (1989) Approximation by superposition of sigmoidal function. *Mathematical control signal system*, **2**.
- Dalenback, B. I. (1994) A macroscopic view of diffuse reflection. *Journal of Audio Engineering Society*, **42**.
- Dart, T. (1954) *The interpretation of Music*, Hutchinson, London.
- Davies, W. J., Orlowski, R. J. and Lam, Y. W. (1994) Measuring auditorium seat absorption. *Journal of Acoustical Society of America*, **96**, 878-888.
- Davis, W. J., Orlowski, R. J. and Lam, Y. W. (1994) Measuring auditorium seat absorption. *Journal of Acoustical Society of America*, **96**, 879-888.
- Davy, J. L., Dunn, I. P. and Dubout, P. (1979) The variance of decay rates in reverberation rooms. *Acustica*, **43**, 12-25.
- Diaz, C. and Pedrero, A. (1999) In *Computational Acoustics in Architecture*(Ed, Sendra, J. J.) WIT Press.
- Djelani, T. and Blauert, J. (2002) Modeling the direction-specific build-up of the precedence effect, Vol.
- Ducourneau, J. and Planeau, V. (2003) The average absorption coefficient for enclosed spaces with non uniformly distributed absorption. *Applied Acoustics*, **64**, 845-862.
- Egan, D. (1972) *Concepts in Architectural Acoustics*, McGraw-Hill Book Company.
- Embrechts, J. J., Archambeau, D. and Stan, G. B. (2001) Determination of the scattering coefficient of random rough diffusing surfaces for room acoustic applications. *Acta Acustica United with Acustica*, **87**.
- Exler, R., Landes, H., Fagner, A. and Lerch, R. (2002) Simulation and measurements of insertion loss of passive silencers. *Acta Acustica United with Acustica*, **88**.
- Eyring, C. F. (1930) Reverberation time in 'dead' room. *Journal of Acoustical Society of America*, **1**, 217-226.
- Fitzroy, D. (1959) Reverberation formula which seems to be more accurate with non-uniform distribution of absorption. *Journal of Acoustical Society of America*, **31**, 893-7.
- Forsyth, M. (1985) *Buildings for Music*, MIT Press, Cambridge.

- Funahashi, K. I. (1989) On the approximate realization of continuous mapping by neural networks. *Neural Network*, **183**, 1989.
- Gade, A. C. (1996) Room acoustic properties of concert halls: quantifying the influence of size, shape and absorption area, Vol. Honolulu.
- Gibbs, B. M. and Jones, D. K. (1972) A simple image method for calculating the distribution of sound pressure levels within an enclosure. *Acustica*, **26**, 24-32.
- Gilbert - Rolfe, J. and Gehry, F. (2002) *Frank Gehry: the city and music*, Routledge.
- Gomes, M. A. and Gerges, S. N. Y. (2001) Modeling of Room Acoustic Parameters Using MLS Technique and Numerical Simulation, Vol. Rio de Janeiro, Brazil.
- Gulsrud, T. (2005) Characteristics of scattered sound from overhead reflector arrays: measurements at 1:8 and full scale. *Journal of Acoustical Society of America*, **117**, 2499.
- Haan, C. H. and Fricke, F. R. (1993) Surface diffusivity as a measure of the acoustic quality of concert halls, Vol. Sydney, Australia.
- Haan, C. H. and Fricke, F. R. (1995) Musician and music critic responses to concert hall acoustics, Vol. Trondheim, Norway.
- Haan, C. H. and Fricke, F. R. (1997) An evaluation of the importance of surface diffusivity in concert halls. *Applied Acoustics*, **51**.
- Harris, C. M. (Ed.) (1991) *Handbook of Noise Control*, Mc Graw-Hill.
- Helmholtz, H. v. (1862) *On Sensations of Tone*, New York.
- Hidaka, T. and Beranek, L. L. (2000) Acoustical design of the Tokyo Opera City Concert Hall. *Journal of Acoustical Society of America*, **107**, 340-354.
- Hidaka, T., Beranek, L. L., Masuda, S., Nishihara, N. and Okano, T. (2000) Acoustical design of the Tokyo Opera City concert hall. *Journal of Acoustical Society of America*, **107**, 340-354.
- Hillier, B., Musgrove, J. and O'Sullivan, P. (1972) Knowledge and design. *Environmental Design: Research and Practice*.
- Hodgson, M. (1991) Evidence of diffuse surface reflections in rooms. *Journal of Acoustical Society of America*, **89**, 765.
- Hodgson, M. (2002) Effect of noise and occupancy on optimal reverberation times for speech intelligibility in classrooms. *Journal of Acoustical Society of America*, **111**.
- Hodgson, M. (2002) Effect of noise and occupancy on optimal reverberation times for speech intelligibility in classrooms. *Journal of Acoustical Society of America*, **111**.
- Hodgson, M. (2003) Ray-tracing evaluation of empirical models for predicting noise in industrial workshops. *Applied Acoustics*, **64**.
- Hodgson, M. (2004) Case Study evaluations of the acoustical designs of renovated university classrooms. *Applied Acoustics*, **65**.

- Hogg, R. V. and Craig, A. T. (1995) *Introduction to Mathematical Statistics*, Prentice Hall.
- Hongisto, V., Lindgren, M. and Helenius, R. (2002) Sound Insulation of double walls - an experimental parametric study. *Acta Acustica United with Acustica*, **88**.
- Hornik, K., Stinchcombe, M. and White, H. (1989) Multilayer feed forward networks are universal approximators. *Neural Network*, **359**.
- Hunt, F. V. (1992) *Origins in Acoustics*, Acoustical Society of America through AIP.
- Hunter, J. L. (1957) *Acoustics*, Prentice-Hall, Inc, Englewood Cliffs, NJ.
- ISO3382 (1997) Measurement of the reverberation time of rooms with reference to other acoustical parameters, Vol. Standards Secretariat, Acoustical Society of America, Melville, New York.
- Jasa, T. and Xiang, N. (2005) Bayesian sampling with applications to energy decay analysis in acoustically coupled spaces. *Journal of Acoustical Society of America*, **117**.
- Jasa, T., Xiang, N. and Kleiner, M. (2005) Sampling methods for decay time evaluation in acoustically coupled space. *Journal of Acoustical Society of America*, **117**.
- Jean, P. and Rondeau, J. F. (2002) A simple decoupled modal calculation of sound transmission between volumes. *Acta Acustica United with Acustica*, **88**.
- Joyce, W. B. (1975) Sabine's reverberation time and ergodic auditoriums. *Journal of Acoustical Society of America*, **58**, 643.
- Kang, J. (2002) Reverberation in Rectangular Long Enclosures with Diffusely Reflecting Boundaries. *Acta Acustica United with Acustica*, **88**, 77-87.
- Kartous, M. S. (2002) Analytical model of light weighting floor simulation, Vol.
- Keller, A. M. (1971) Considerations on the random traversal of convex bodies and solutions for general cylinders. *Radiation Research*, **47**, 359-376.
- Kernen, U. E. (2001) Airborne Sound Insulation of Floating Floors. *Acta Acustica United with Acustica*, **87**.
- Kirkegaard, D. L. (1993) Measurement informing the design process: Experiences in occupied hall analysis. *Journal of Acoustical Society of America*, **93**, 2302.
- Kirkegaard, D. L. (1996) Acoustical Measurement in occupied halls. *Journal of Acoustical Society of America*, **100**, 2836.
- Kirkegaard, D. L. (1996) Sound absorption of occupied chairs as a function of chair design and audience clothing. *Journal of Acoustical Society of America*, **99**, 2458-2500.
- Kirkegaard, R. L. (1999) The compleat concert hall: A century of acoustics development and its lessons for the design of concert halls, Vol.
- Kirkegaard, R. L. (2005) Personal correspondence, Vol.
- Kleiner, M., Dalenback, B. I. and Svensson, P. (1993) Auralization- an overview. *Journal*

- of Audio Engineering Society*, **41**.
- Knudsen (1932) *Architectural Acoustics*.
- Knudsen, V. O. and Harris, C. M. (1968) *Acoustical Designing in Architecture*, John Wiley and Sons.
- Kostek, B. and Neubauer, R. (2002) Reverberation condition evaluation for rectangular rooms with non-uniformly distributed sound absorption, Vol. Bochum.
- Kosten, C. W. (1960) *Acustica*, **10**, 245.
- Kosten, C. W. (1966) New method for the calculation of the reverberation time of halls for public assembly. *Acustica*, **16**, 325-30.
- Krokstad, A., Strom, S. and Sorsdal, S. (1968) Calculating the acoustical room response by the use of a ray technique. *Journal of Sound vibration*, **8**.
- Kuhl, W. (1954) Über Versuche zur Ermittlung der günstigsten Nachhallzeit grosser Musikstudios. *Acustica*, 618.
- Kurra, S. and Arditi, D. (2001) Determination of sound transmission loss of multilayered elements Part 1: Predicted and measured results. *Acta Acustica United with Acustica*, **87**.
- Kuttruff, H. (1995) A simple iteration scheme for the computation of decay constants in enclosures with diffusively reflecting boundaries. *Journal of Acoustical Society of America*, **98**, 288-293.
- Kuttruff, H. (1999) *Room Acoustics*, Spon Press.
- Lam, Y. W. (1994) On the parameters controlling diffusion calculation in a hybrid computer model for room acoustic prediction, Vol. UK.
- Lawrence, A. (1970) *Architectural Acoustics*, Elsevier Publishing Company Limited.
- Lindsay, R. B. (Ed.) *Acoustics: Historical and philosophical development*.
- Lundeby, A. and Vigran, T. E. (1999) Uncertainties of Measurements in Room Acoustics. *Acustica*, **81**, 344-355.
- Mahalingam, G. (1999) A new algorithm for the simulation of sound propagation in spatial enclosures, Vol.
- Mahdavi, A., Liu, G. and Ilal, M. E. (1997) CASCADE: A novel computational design system for architectural acoustics, Vol.
- Mankovsky, V. S. (1971) *Acoustics of Studios and Auditoria*.
- Marshall, A. H. (1967) A note on the importance of room cross section in concert halls. *Journal of Sound and Vibration*, **7**, 116-118.
- Marshall, A. H. and Kirkegaard, D. L. (1993) The Academy of Music, Philadelphia - Preliminary model studies of the potential for coupled volumes. *Journal of Acoustical Society of America*, **93**, 2302.
- Mastracco, J. M. and Sneck, H. J. (1997) The role of the microphone in the measurement of reverberation: an application of the scientific method. *Acustica*, **83**.

- Mehta, M., Johnson, J. and Rocafort, J. (1999) *Architectural Acoustics - Principles and design*, Prentice Hall.
- Mehta, M. L. and Mulholland, K. A. (1976) Effect of Non-uniform distribution of absorption on reverberation time. *Journal of Sound vibration*, **46**.
- Meyer, J. (1978) Raumakustik und Orchesterklang in den Konzertsalen Joseph Haydn. *Acustica*, **41**, 145-162.
- Millington, G. (1932) A modified formula for reverberation. *Journal of Acoustical Society of America*, **4**, 69-81.
- Monks, M., Oh, B. M. and Dorsey, J. (1998) Audio optimization: goal based acoustic design, Vol. MIT.
- Morimoto, M., Jinya, M., Nakagawa, K. and Sakagami, K. (2002) Effects of frequency characteristics of reverberation time on listener envelopment, Vol.
- Nakajima, T. and Ando, Y. (1997) In *Music and Concert Hall Acoustics*, Academic Press.
- Nannariello, J. and Fricke, F. R. (1999) The Prediction of Reverberation time using neural network analysis. *Applied Acoustics*, **58**, 305-325.
- Nannariello, J. and Fricke, F. R. (2001) A neural network analysis of the effect of geometric variables on concert hall G values. *Applied Acoustics*, **62**, 1397-1410.
- Nannariello, J. and Fricke, F. R. (2001) The use of neural network analysis to predict the acoustic performance of large rooms -Part1. Predictions of the parameter G utilizing numerical simulation. *Applied Acoustics*, **62**, 918-950.
- Nannariello, J. and Fricke, F. R. (2001) The use of neural network analysis to predict the acoustic performance of large rooms - part II. Predictions of the acoustical attributes of concert halls utilizing measured data. *Applied Acoustics*, **62**.
- Nannariello, J. and Fricke, F. R. (2002) A neural computation method of predicting the early interaural cross-correlation coefficient (IACCE3) for auditoria. *Applied Acoustics*, **63**, 627-641.
- Nannariello, J., Hodgson, M. and Fricke, F. R. (2001) Neural network predictions of speech levels in university classrooms. *Applied Acoustics*, **62**.
- Naylor, G. and Rindel, J. H. (1992) Predicting room acoustical behavior with the ODEON computer model, Vol. New Orleans.
- Neubauer, R. (2001) Estimation of reverberation time in rectangular rooms with non-uniformly distributed absorption using a modified Fitzroy equation. *Building Acoustics*, **8**, 115-37.
- Neubauer, R. (2001) Existing reverberation time formulae - a comparison with computer simulated reverberation time, Vol. Hong Kong, China.
- Nijs, L., Jansens, G., Vermeir, G. and van der Voorden, M. (2002) Absorbing surfaces in ray-tracing programs for coupled spaces.
- Nishihara, N., Hidaka, T. and Beranek, L. L. (2001) Mechanism of sound absorption by

- seated audience in halls. *Journal of Acoustical Society of America*, **110**, 2398.
- Ogilvy, J. A. (1991) *Theory of Wave Scattering From Random Rough Surfaces*, Adam Hilger.
- Organization, C. H. <http://www.concerthalls.unomaha.edu/>, Vol.
- Otsuru, T. and Tomiku, R. (1999) Modeling and accuracy of sound field analysis by finite element method on building environments, Vol.
- Padovan, R. (1999) *Proportion: Science, Philosophy, Architecture*, E & FN Spon.
- Pelorsen, X., Vian, J.-P. and Polack, J.-D. (1992) On the variability of room acoustical parameters: reproducibility and statistical validity. *Applied Acoustics*, **37**, 175-198.
- Pfeiffer, S. (2005) Returning an acoustic legend to its original glory (and then some). *Journal of Acoustical Society of America*, **117**.
- Picard, M. and Bradley, J. S. (2001) Revisiting speech interference in classrooms. *Audiology*, **40**.
- Picaut, J., Simon, L. and Polack, J.-D. (1999) Sound field in long rooms with diffusively reflecting boundaries. *Applied Acoustics*, **56**.
- Pierce, A. D. (1981) *Acoustics: An introduction to its physical principles and applications*.
- Plato (1957) *Plato's cosmology; the Timaeus of Plato*, Liberal Arts Press, New York.
- Rabenstein, R., Schips, O. and Stenger, A. (1997) *Acoustic rendering of buildings*, Vol.
- Reichardt, W., Abdel, A., Alim, O. and Schmidt, W. (1975) Definition und Messgrundlage eines objektiven Masses zur Ermittlung der Grenze zwischen brauchbarer und unbrauchbarer Durchsichtigkeit bei Musikdarbietung. *Acta Acustica United with Acustica*, **32**, 126-137.
- Rindel, J. H. (2000) The use of computer modeling in room acoustics. *Journal of Vibroengineering*, **3**.
- Rindel, J. H. and Christensen, C. L. (2003) *Room Acoustic Simulation and Auralization - How close can we get to the real room?*, Vol. Melbourne.
- Sabine, W. C. (1922) In *Collected Papers on Acoustics*, Harvard University Press.
- Sakurai, M. (2000) *Computational Systems for Sound Fields, as Tools in Design and Diagnosis*, Vol. Kobe University.
- Sanmartin, R., Vela, A. and San Martin, M. (2002) Comparative analysis of two acoustic simulation, Vol.
- Satoh, F., Shimada, Y., Hidaka, Y. and Tachibana, H. (1996) Comparison between the 1/10 scale model experiment and the full-scale measurement in a concert hall. *Journal of Acoustical Society of America*, **100**.
- Schaudinischky (1976) *Sound, Man and Building*, Applied Science Publishers, London.
- Schroeder, M. R. (1962) *Digital computers in room acoustics*, Vol. Copenhagen.

- Schroeder, M. R. (1965) New Method of measuring reverberation time. *Journal of Acoustical Society of America*, **1965**.
- Schroeder, M. R. (1966) Architectural Acoustics. *Science*, **151**, 1344-1359.
- Schroeder, M. R. (1979) Integrated-Impulse method measuring sound decay without using impulses. *Journal of Acoustical Society of America*, **66**.
- Schroeder, M. R. (1985) Springer-Verlag.
- Schroeder, M. R. (1997) In *Music and Concert Hall Acoustics*(Ed, Ando, Y.) Academic Press.
- Schroeder, M. R. and Kuttruff, H. (1962) On frequency response curves in rooms. Comparison of experimental, theoretical and Monte-Carlo results for the average frequency spacing between maxima. *Journal of Acoustical Society of America*, **34**, 76-80.
- Sendra, J. J. (1999) In *Computational Acoustics in Architecture*(Ed, Sendra, J. J.) WIT Press.
- Shibayama, H. (1995) Modeling and complication for environment noise, Vol. Trondheim, Norway.
- Summers, J. E. (2002) Comments on "Absorbing surfaces in ray-tracing programs for coupled space". *Applied Acoustics*.
- Svioja, L. (2000) Modeling Techniques for Virtual Acoustics, Vol. Helsinki University of Technology.
- Talaska, R. H. and Boner, R. E. (Eds.) (1987) *Theatres for drama performance: recent experience in acoustical design*.
- Taylor, C. (2000) In *Sound*(Eds, Kruth, P. and Stobart, H.) University Press, Cambridge.
- Templeton, D., Sacre, P., Mapp, P. and Saunders, D. (1997) *Acoustics in the Built Environment - Advice for the Design Team*, Architectural Press.
- Terao, M., Sekine, H. and Itoh, M. (1999) Comparison between wave theory and energy method in acoustic prediction of HVAC duct networks, Vol.
- Thiele, R. (1953) Richtungsverteilung und Zeitfolge der Schallruck wurfe in Raumen. *Acta Acustica United with Acustica*, **3**, 291-302.
- Thompson, E. (2002) *The soundscape of modernity: architectural acoustics and the culture of listening in America*, MIT Press.
- Tohyama, M., Suzuki, H. and Ando, Y. (1995) *The nature and technology of acoustic space*, Academic Press.
- van der Voorden, M., Nijs, L. and Spoorenberg, H. (2001) Simulation of sound insulation properties of "vacuum zappi facade panels", Vol.
- van der Voorden, M., Nijs, L., Vermeir, G. and Jansens, G. (1999) The applicability of ray tracing based simulation tools to predict sound pressure levels and reverberation times in "coupled spaces", Vol.



- Van Renterghem, T., Botteldooren D, Cornelis, W. M. and Gabriel, D. (2002) Reducing screen induced refraction of noise barriers in wind by vegetative screens. *Acta Acustica United with Acustica*, **88**.
- Vitruvius (1960) *The Ten books on Architecture*, Dover Publication.
- Von Simson, O. (1962) *The Gothic Cathedral*, Princeton University Press.
- Vorlander, M. and Bietz, H. (1994) Comparison of Methods for measuring reverberation time. *Journal of Acoustical Society of America*, **80**.
- Vorlander, M. (1995) International round robin on room acoustical computer simulations, Vol. Trondheim, Norway.
- Vorlander, M. and Mommertz, E. (2000) Definition and measurement of random-incidence scattering coefficients. *Applied Acoustics*, **60**.
- Walerian, E., Janczur, R. and Czechowicz, M. (2002) Practical Description of Diffraction at Wedges Applied to Propagation Model in a Built-up Area. *Acta Acustica United with Acustica*, **88**.
- Weise, W. (2001) Corrections of Incident Power in Sound Reduction Index Measurement. *Acta Acustica United with Acustica*, **87**.
- Wilson, C. E. (1989) *Noise Control: Measurement, Analysis, and control of sound and vibration*.
- WINTERS, R. (2003) Perfect Pitch-Nagata Acoustics, a virtuoso in sound, brings a new dimension to Frank Gehry's Walt Disney Concert Hal. *Time*.
- Wu, S. (2001) A new criterion for concert hall loudness evaluation. *Acta Acustica United with Acustica*, **87**.
- Xiang, N. (1992) Using M-sequences for determining the impulse response of LTI-systems. *Signal Processing*.
- Xiang, N. (1995) Evaluation of reverberation times using a nonlinear regression approach. *Journal of Acoustical Society of America*, **98**, 2112-2121.
- Xiang, N. and Daigle, J. (2005) Maximum-length-related sequences and a specialized deconvolution for multiple acoustic channel estimation. *Journal of Acoustical Society of America*.
- Xiang, N. and Genuit, K. (1996) Characteristic Maximum-Length Sequences for interleaved sampling method. *Acta Acustica United with Acustica*, **82**.
- Xiang, N. and Goggans, P. M. (2001) Evaluation of decay times in coupled spaces: Bayesian parameter estimation. *Journal of Acoustical Society of America*, **110**, 1415-1424.
- Xiang, N. and Goggans, P. M. (2003) Evaluation of decay times in couples spaces: Bayesian decay model selection.
- Xiang, N., Goggans, P. M., Jasa, T. and Kleiner, M. (2005) Evaluation of decay time in coupled spaces: reliability analysis of Bayesian decay time estimation. *Journal of Acoustical Society of America*, **117**.

- Zeng, X., Chen, K. a. and Sun, J. (2002) Modeling the sound fields in rooms with multiple sources using a hybrid image method including phase.
- Zhang, X. (2003) A new formula for reverberation time. *Acta Acustica United with Acustica*, **89**.

## Vita

Yan Zhang was born in Oct, 1975 in China. She received a Bachelor's degree in Architectural Thermal Engineering from Harbin Institute of Technology in 1995, and a Master's degree in Thermal Engineering from Tsinghua University in 1998.

From 1996 to 2001 she worked at Tsinghua Tongfang Corporation in Beijing as a consultant and a researcher to develop and implement new technology for projects with high-end or demanding building performance requirements. She was a leading member of a team developing licensed design software. She also received a certification of Mechanical Engineer from Chinese Academy of Science.

She began her Ph.D. study in College of Architecture at Georgia Tech in 2001 with a minor in mathematical statistics. She has coauthored three refereed journal papers and about ten conference papers. She is a student member of the Acoustical Society of America.