

Design of Floors for Vibration: A New Approach

(Revised Edition, February 2009)

A L Smith BA MEng (Cantab)

S J Hicks BEng PhD (Cantab)

P J Devine BEng PgDip MSc CEng MICE

Published by:
The Steel Construction Institute
Silwood Park
Ascot
Berkshire SL5 7QN

Tel: 01344 636525

Fax: 01344 636570

© 2007, 2009 The Steel Construction Institute

Apart from any fair dealing for the purposes of research or private study or criticism or review, as permitted under the Copyright Designs and Patents Act, 1988, this publication may not be reproduced, stored or transmitted, in any form or by any means, without the prior permission in writing of the publishers, or in the case of reprographic reproduction only in accordance with the terms of the licences issued by the UK Copyright Licensing Agency, or in accordance with the terms of licences issued by the appropriate Reproduction Rights Organisation outside the UK.

Enquiries concerning reproduction outside the terms stated here should be sent to the publishers, The Steel Construction Institute, at the address given on the title page.

Although care has been taken to ensure, to the best of our knowledge, that all data and information contained herein are accurate to the extent that they relate to either matters of fact or accepted practice or matters of opinion at the time of publication, The Steel Construction Institute, the authors and the reviewers assume no responsibility for any errors in or misinterpretations of such data and/or information or any loss or damage arising from or related to their use.

Publications supplied to the Members of the Institute at a discount are not for resale by them.

Publication Number: SCI P354

ISBN 10: 1-85942-176-8

ISBN 13: 978-1-85942-176-5

British Library Cataloguing-in-Publication Data.

A catalogue record for this book is available from the British Library.

FOREWORD

Design guidance on the vibration of floors was first published by The Steel Construction Institute in 1989, and related only to normal office building environments. It was prepared by Dr T A Wyatt of Imperial College London with assistance from Dr A F Dier of SCI. It has been widely used in practice and has stood the test of time.

This new guidance document has been written to enable designers to determine the vibration response of sensitive floors with improved accuracy. It will enable the response to be compared with BS 6472 and ISO 10137 for general structures, and with the specific NHS performance standard for hospitals, *Health Technical Memorandum 08-01*. It includes design guidance for all types of floor construction using steel members and for a variety of use characteristics. It makes reference to research and measurements in a variety of buildings that have demonstrated the good quality vibration performance that can be achieved with composite floors.

For composite floors, the work leading to this publication was part-funded by Corus Construction Services & Development and by The European Coal and Steel Community through the project entitled 'Generalisation of criteria for floor vibrations for industrial, office, residential and public buildings and gymnastic halls' (ECSC project PR7210-PR-314). The ECSC project was carried out by the following Partners:

- Rheinisch-Westfälische Technische Hochschule (RWTH) Aachen, Institute of Steel Construction (Project co-ordinator).
- Arcelor Profil Luxembourg Research
- TNO Building and Construction Research
- The Steel Construction Institute (SCI)

For lightweight floors, the work was part-funded by Corus Strip Products UK and by the DTI Partners in Innovation project entitled 'Holistic assessment of the vibration sensitivity of lightweight floors for various use patterns' (DTI Reference: STBF/004/00053C CC2529). The DTI project was carried out by the following Partners:

- Atkins Design Environment and Engineering.
- Terrapin
- Metsec
- NHBC
- Corus Strip Products UK
- TRADA
- The Steel Construction Institute (SCI)

The publication was prepared by Mr Andrew Smith, Dr Stephen Hicks and Mr Paul Devine of The Steel Construction Institute. The authors would also like to thank Professor Aleksandar Pavic and Professor Mark Lawson for their comments and advice on the publication, which are gratefully acknowledged. Appendix C of the publication: *Dynamic testing of building floors* was written by Professor Aleksandar Pavic and Dr Paul Reynolds, both of Sheffield University.

This revised edition includes the latest advice on health buildings. Opportunity was taken to include the amendments given in corrigendum 1 and correct some typographical errors. The values in the worked examples have been adjusted in line with the corrigendum.

Contents

	Page No.
FOREWORD	iii
SUMMARY	vii
NOTATION	xi
1 INTRODUCTION	1
1.1 The vibration of floors	1
1.2 Traditional approaches to design	2
1.3 Scope of this guide	2
2 THEORY OF VIBRATION	4
2.1 Continuous and Discrete Systems	4
2.2 Frequency	5
2.3 Excitation	9
2.4 Response	10
3 SOURCES OF VIBRATIONS	14
3.1 Dynamic excitation forces	14
4 DESIGN CONSIDERATIONS FOR FLOORS	20
4.1 Structural considerations	20
4.2 Architectural considerations	23
5 ACCEPTABILITY OF VIBRATIONS	25
5.1 Considerations	25
5.2 Human perception	25
5.3 Acceptance criteria	29
5.4 Sensitive Processes	32
6 GENERAL ASSESSMENT FOR ESTABLISHING VIBRATION RESPONSE	34
6.1 Finite element modelling (FE)	34
6.2 Modal mass	37
6.3 Response analysis	38
6.4 Summing accelerations	41
6.5 Acceptability criteria for continuous vibrations	42
6.6 Vibration dose values (VDVs)	44
6.7 Design process chart	45
7 SIMPLIFIED ASSESSMENT FOR STEEL FLOORS	46
7.1 Fundamental frequency	46
7.2 Minimum floor frequency	49
7.3 Modal Mass	49
7.4 Mode shape factor	52
7.5 Response acceleration	53
7.6 Acceptance criteria	54
8 SPECIAL CASES	56
8.1 Floors subject to rhythmic activities	56
8.2 Hospital floors	58
8.3 Light steel floors	60
8.4 Car parks	65

9	REFERENCES	67
	APPENDIX A Comparison of analysis methods with measurements	73
	A.1 Test procedures	73
	A.2 Results from testing office floors	73
	A.3 Results from testing hospital floors	74
	A.4 Comparison of predictions with measurements	76
	A.5 Lightweight floors	78
	APPENDIX B Retrofit and remedial strategies	80
	B.1 Evaluation of floor vibration problems	80
	B.2 Retrofit and remedial measures for Steel-concrete construction	81
	B.3 Retrofit strategies for machine induced vibrations	82
	APPENDIX C Dynamic testing of building floors	84
	C.1 Modal testing	84
	C.2 Modal testing of floors with measurements made of the excitation force	86
	C.3 Vibration performance assessment	91
	C.4 Management issues	95
	APPENDIX D Worked Examples	97
	D.1 Vibration response of a composite floor	98
	D.2 Vibration response of a lightweight floor	106
	D.3 Design for rhythmic activity	112

SUMMARY

This publication provides guidance for vibration design of all steel-framed floor and building types.

It deals with the human perception of vibration and the criteria by which it is measured. The concepts of floor response and the different types of excitation produced by occupant induced vibrations are explained. Simple design procedures are presented which show how to calculate the floor acceleration, to weight it to reflect human perception, and to compare it with the acceptance levels in BS 6472 and ISO 10137 for building designs and in the NHS performance standard for hospitals, Health Technical Memorandum 08-01.

The design procedures are valid for steel-framed floors using hot rolled steel sections and lightweight floors using thin cold formed steel members. The simplified procedure is particularly suited to framing arrangements that are generally regular in plan.

Results from testing which have been used to develop the rules contained within this guide have been included in Appendix A. Additional information on managing problems in a remedial situation is given in Appendix B. Specialist guidance on dynamic testing of buildings is provided in Appendix C; this has been specially written by Professor Aleksander Pavic and Dr Paul Reynolds, both of Sheffield University. A set of worked examples, illustrating the design procedures is given in Appendix D.

Dimensionnement des planchers par rapport aux vibrations : une nouvelle approche

Résumé

Cette publication est destinée à servir de guide de dimensionnement concernant les vibrations de tout type de planchers reposant sur une ossature en acier, pour tout type de bâtiments.

Elle est basée sur la perception humaine des vibrations et le critère qui permet de mesurer cette perception. Le concept de réponse du plancher et les différents types d'excitation produites par l'occupant, induisant des vibrations, sont expliqués. Des procédures simples de dimensionnement sont présentées. Elles montrent comment calculer l'accélération des planchers, comment celle-ci se répercute sur la perception humaine et comment prendre en compte les niveaux d'acceptation des normes «BS 6472» et «ISO 10137», pour le dimensionnement des immeubles et, dans la «NHS performance standard for hospitals, Health Technical Memorandum 08-01».

Les procédures de dimensionnement sont applicables à des planchers reposant sur des profils laminés à chaud et des planchers légers utilisant des profils à froid. La procédure simplifiée est particulièrement adaptée à des planchers de formes simples.

Les résultats expérimentaux qui ont été utilisés pour développer les règles de calculs proposées dans ce guide sont donnés en annexe A. Des informations complémentaires concernant la remédiation face à des problèmes existants figurent à l'annexe B. Des conseils pour la réalisation d'essais dynamiques sont donnés à l'annexe C ; cette partie a été rédigée par le Professeur Aleksander Pavic et le Docteur Paul Reynolds, de l'Université de Sheffield. L'annexe D est consacrée à une série d'exemples.

Schwingungsberechnung von Decken: ein neuer Ansatz

Zusammenfassung

Diese Publikation stellt eine Anleitung zur Schwingungsberechnung aller Decken- und Gebäudearten im Stahlbau bereit.

Sie befasst sich mit der menschlichen Wahrnehmung von Schwingungen und den Messkriterien hierfür. Erläutert werden die Konzepte der Deckenreaktion und die verschiedenen Arten der Erregung durch benutzerinduzierte Schwingungen. Einfache Berechnungsverfahren werden vorgestellt die zeigen, wie die Deckenbeschleunigung berechnet wird, wie die Abwägung der menschlichen Wahrnehmung erfolgt, und wie die Vergleiche mit dem Akzeptanzniveau in BS 6472 und ISO 10137 für Gebäude und in Health Technical Memorandum 08-01 für Krankenhäuser ausfallen.

Das Berechnungsverfahren ist gültig für Decken aus warm gewalzten Stahlprofilen und Leichtbaudecken mit Kaltprofilen aus Stahl. Das einfache Verfahren ist insbesondere passend für im Allgemeinen regelmäßige Trägergrundrisse.

Testergebnisse, die dazu dienen, die in diesem Leitfaden enthaltenen Regeln aufzustellen, sind in Anhang A enthalten. Zusätzliche Information zur Bewältigung von Problemen in einer lösbaren Situation finden sich in Anhang B. Eine spezielle Anleitung zu dynamischen Versuchen in Gebäuden wird in Anhang C bereitgestellt, der extra von Professor Alexander Pavic und Dr. Paul Reynolds, beide von der Universität Sheffield, geschrieben wurde. Eine Reihe von Berechnungsbeispielen, die die Berechnungsverfahren beschreiben, findet man im Anhang D.

Cálculo de vibraciones en forjados: un nuevo método

Resumen

Esta publicación es una guía para el cálculo de vibraciones en cualquier tipo de forjado y de edificio.

Trata la percepción humana de las vibraciones y los criterios que se utilizan para medirlas. Se describen los conceptos de la respuesta del forjado y los distintos tipos de excitación producidos por las vibraciones generadas por los ocupantes. Se presentan simples procedimientos de cálculo para demostrar la aceleración del forjado y para valorar la misma reflejando así como compararla con los niveles aceptables en las normas BS 6472 e ISO 10137 para cálculo de edificios y en la normativa para el comportamiento de hospitales Health Technical Memorandum 08-01 del NHS (National Health Service).

Los procedimientos de cálculo son válidos para forjados con estructura de acero, tanto con secciones laminadas en caliente como con secciones de acero galvanizado laminado en frío. El método simplificado es de aplicación especialmente en configuraciones regulares en planta.

Resultados de ensayos que han sido utilizados para el desarrollo de los métodos que se presentan en esta publicación se incluyen en el Anexo A. El Anexo B presenta información relativa a la gestión de problemas en situaciones remediadoras. El Anexo C ofrece asesoramiento especializado para ensayos de vibraciones en edificios; este ha sido escrito específicamente por el Catedrático Aleksander Pavic y el Dr Paul Reynolds, ambos de la Universidad de Sheffield. Finalmente, el anexo D muestra una serie de ejemplos resueltos, ilustrando el procedimiento de cálculo.

Un approccio innovativo per la progettazione di solai nei confronti delle vibrazioni

Sommario

Questa pubblicazione fornisce una guida per la progettazione nei confronti delle vibrazioni di tutti i solai di strutture in acciaio e di altri tipi di edifici. Viene introdotto il concetto di percezione umana delle vibrazioni e si considerano i relativi criteri di misura, spiegando i meccanismi della risposta di piano ed i differenti tipi di eccitazione indotti dall'uso dell'edificio. Sono presentate alcune procedure semplificate per la stima dell'accelerazione di piano e per valutare come queste vengono percepite dagli occupanti, anche in relazione ai livelli di accettabilità contenuti nelle BS 6472 e ISO 10137, per la progettazione degli edifici, e nelle NHS che dettagliano le prestazioni da garantire per gli ospedali in relazione alla Raccomandazione Tecnica sulla Salute 08-01.

Le procedure riportate nella pubblicazione sono applicabili a strutture in acciaio sia tradizionali, realizzate con profili laminati a caldo, sia più leggere dove sono impiegati profili sagomati a freddo. La procedura semplificata è raccomandata nel caso in cui il sistema portante sia regolare in pianta.

Le procedure riportate nella guida sono state sviluppate sulla base di prove sperimentali ed i relativi principali risultati sono riportati nell'Allegato A. Nell'Appendice B sono contenute utili informazioni sulla gestione e rimedi di inconvenienti. La guida dettagliata sulla sperimentazione dinamica degli edifici, riportata nell'Allegato C, è stata sviluppata dal professor Aleksander Pavic e dal dottor Paul Reynolds, entrambi dell'Università di Sheffield. L'allegato D riporta infine alcuni esempi applicativi illustrativi delle procedure di progetto.

NOTATION

$a(t)$	acceleration as a function of time
a_{peak}	peak acceleration
a_{rmq}	root-mean-quad acceleration
a_{rms}	root-mean-square acceleration
$a_w(t)$	frequency weighted acceleration as a function of time
$a_{w,\text{rms}}$	frequency-weighted rms acceleration
b	floor beam spacing
b_{eff}	effective breadth of a composite beam
$D_{n,h}$	dynamic magnification factor corresponding to mode n and harmonic h
e	excitation point
E_a	elastic modulus of steel
E_c	dynamic elastic modulus of concrete
EI	dynamic flexural rigidity
EI_b	dynamic flexural rigidity of composite secondary floor beam or joist
EI_s	dynamic flexural rigidity of slab or floor material
f	frequency
$F(t)$	load function of rhythmic activities per unit area as a function of time
$F(x,t)$	forcing function as a function of position and time
f_0	frequency of a single degree of freedom system, or an equivalent SDOF system
f_1	lowest (fundamental) frequency of a continuous system
F_h	harmonic force amplitude
F_1	impulsive excitation force amplitude
f_n	frequency of the mode n of a continuous system
f_p	fundamental frequency of a forcing function
$g_n(t)$	time varying amplitude function
H	number of harmonics
h	harmonic number
I_b	composite or non-composite second moment of area of secondary beam or joist
I_p	composite or non-composite second moment of area of primary beam
I_s	second moment of area of slab or floor material
KE	kinetic energy
L	span
L_{eff}	effective floor length
L_p	length of a walking path
L_x	width of a bay

L_y	length of a bay
m	distributed mass
M	modal mass
n	mode number
N	number of modes
n_x	number of bays in the direction of the primary beam span
n_y	number of bays in the direction of the secondary beam span
q	weight of participants per unit area
Q	static force exerted by an ‘average person’
r	response point
R	response factor
S	effective floor width
t	time
T	time period
T_a	duration of an activity
v	velocity
VDV	vibration dose value
v_p	walking velocity
W	weighting factor
x	position along a beam
x,y	position on a beam or slab
ϕ_h	phase of the h^{th} harmonic
$\phi_{n,h}$	phase of the n^{th} mode relative to the h^{th} harmonic
δ	deflection
α	is the modular ratio
α_c	contact ratio
α_h	Fourier coefficient of the h^{th} harmonic
ζ	critical damping ratio
β_n	frequency ratio (taken as f_p/f_n)
μ_e	unity normalised amplitude at the excitation point
$\mu_n(x)$	unity normalised amplitude at position x
μ_r	unity normalised amplitude at the response point
ρ	resonance build-up factor

1 INTRODUCTION

1.1 The vibration of floors

In recent years, there has been an increase in demand for buildings that are fast to construct, have large uninterrupted floor areas and are flexible in their intended final use. Modern design and construction techniques enable the steel construction sector to satisfy such demands and produce structures which are competitive in terms of overall cost. This trend towards longer span, lightweight floor systems, with their tendency to lower natural frequencies and reduce natural damping, has created a greater awareness of the dynamic performance of floors when subjected to human activities.

The vibration of floors can arise from external sources such as road and rail traffic. Where such problems are anticipated, it is preferable to isolate the building as a whole. This aspect of vibration control is not discussed in this Guide, which addresses only floor vibrations caused by internal sources.

The most usual and important internal source of dynamic excitation is pedestrian traffic. A person walking at a regular pace applies a periodically repeated force to the floor, which may cause a build up of response. In general, where such activities are envisaged, the structure should not only be sufficiently strong but also comply with comfort and serviceability criteria.

Human perception of vibration is, at one level, very sensitive; the acceptance criterion is likely to be set at a low level. At another level, it is very insensitive; a substantial quantitative change in the amplitude of vibration corresponds to a relatively small qualitative change in perception. If a person is asked to express an opinion on his perception of vibration in two different rooms on separate occasions, it is unlikely he will be able to distinguish a difference unless the quantitative difference is at least a factor of 2. (There are also substantial differences between people and there may also be differences between nationalities.) Human reaction at these levels is substantially psychological, depending partly on the delicacy of the activity being performed, and response to vibrations is often affected by other stimuli (visual and auditory). Although floor vibration may induce a sense of insecurity in some people, it must be stressed that perception of floor vibration does not necessarily imply any lack of structural safety.

Once constructed, it is very difficult to modify an existing floor to reduce its susceptibility to vibration, as only major changes to the mass, stiffness or damping of the floor system will produce any perceptible reduction in vibration amplitudes. It is therefore important that the levels of acceptable vibration be established at the conceptual stage, paying particular attention to the anticipated usage of the floors. The client must be involved in this decision, as the selected design target level for vibrational response may have a significant bearing on both the cost and floor construction details for the project.

Historically, designers have used the natural frequency of the floor as the sole measure of acceptable performance^[1]. A sufficiently high natural frequency means that a floor is effectively 'tuned' out of the frequency range of the first harmonic component of the walking activity (however, although the response is

much smaller, resonance can still occur with the second, third and fourth harmonic components).

1.2 Traditional approaches to design

In the United Kingdom, the traditional approach used to design conventional floors for serviceability criteria has been to check the primary and secondary beams independently for a minimum natural frequency of 4.0 Hz, and assuming that simply-supported boundary conditions exist. The frequency is calculated from the stiffness of the gross composite section, and uses a load corresponding to the self-weight, services, ceiling and 10% of the imposed load. The figure of 10% represents the permanent loading on the floor for a building of normal usage (e.g. an office with furniture, filing cabinets, etc), and correlates with the view that vibrations on lightly furnished floors are more perceptible than in fully occupied buildings. Buildings designed in this way have generally performed well.

The minimum frequency limit, given above, merely reduces the probability of adverse comments arising due to occupant-induced vibrations. The limit simply minimises the likelihood of resonant excitation occurring when the first harmonic component of the activity coincides with the fundamental frequency of the overall floor system. It does not, however, give any indication of the level of floor response in service.

It therefore follows that ensuring a design meets certain minimum frequency limits may still result in a floor that is unacceptable in service. Conversely, some current designs could be over-conservative. Thus, to ensure that vibration serviceability criteria are met, the designer should make realistic predictions of the floor response that will be encountered in service by considering the excitation directly and comparing this value with acceptability criteria^[2,3].

1.3 Scope of this guide

Floor vibration is not a new phenomenon; the 'live' feel of timber floors under pedestrian loading is well established. However, because of the increasing trend towards lighter, longer span floors, the issue is becoming increasingly important. This Guide has not therefore been prepared in response to any existing problems but rather it is intended that its use will prevent problems occurring in the future.

The main purpose of this Guide is to provide a practical method for assessing the likely vibrational behaviour of floors in steel-framed buildings. The subject of floor vibration is complex and so this guide not only presents a suitable analysis method, but also a simplified design method for both composite and lightweight floors.

A set of worked examples, illustrating the procedures, is given in Appendix D. The examples have been prepared to permit a conservative design assessment to be undertaken by those possessing only a limited knowledge of structural dynamics.

Results from testing which have been used to establish the rules contained within this guide have been included in Appendix A. Information on dealing

with vibration problems as a remedial measure, is included in Appendix B. Specialist guidance on dynamic testing of buildings is provided in Appendix C.

Ultimately, it is intended that the publication of this Guide will aid both designers and clients in setting sensible targets for acceptable levels of vibration, which can then be incorporated into the design of the floor structure to produce economic, usage-related, buildings.

2 THEORY OF VIBRATION

Please note that all equations involving a sine or cosine term use radians, not degrees.

This section provides a brief overview of the theory on which the guidance in this publication is based. For a more detailed discussion on the theory of vibration, it is suggested that the reader consult textbooks such as Clough & Penzien^[4], Maguire & Wyatt^[5], Meirovitch^[6] and Tongue^[7].

Dynamics is a subject that considers the behaviour and effect of motion on a body and, as such, is very different from the usual concerns of structural design that generally relate to static behaviour, even in the case of time varying loads such as wind. Vibration is a specific part of dynamics that considers cyclic (i.e. repetitive) motion.

2.1 Continuous and Discrete Systems

Vibration is generally concerned with the movement of mass. Each vibration problem can therefore be classed in one of two categories, namely continuous systems and discrete systems. Continuous systems are those in which all the mass concerned is directly linked together, such as in a beam in bending or a guitar string. Discrete systems are those where the masses concerned are independent, such as the horizontal vibration of a multi-story building (taking the floors as the masses and the columns as the springs). Problems involving continuous systems are generally solved using integration of continuous functions, whereas discrete systems can be solved by the use of matrices. As this second method is simpler, there are techniques that discretise continuous systems so that they can be solved using methods for discrete systems; the most well known of these techniques is finite element (FE) analysis.

2.1.1 Continuous Systems

The behaviour of continuous systems is governed by equations that relate the response (in terms of displacement, velocity and acceleration) at a certain position and time to the mass and stiffness of the system and an initial force. The governing equation for a beam in bending, for example, is:

$$m \frac{\partial^2 w}{\partial t^2} + EI \frac{\partial^4 w}{\partial x^4} = F(x, t) \quad (1)$$

where:

m is the distributed mass

w is the displacement of the beam, as a function of x and t

t is the time

EI is the bending stiffness

x is the position along the beam

$F(x, t)$ is the forcing function.

The natural frequencies of the beam can be calculated from this equation by setting the forcing function to zero and applying the appropriate boundary conditions (see Section 2.2).

2.1.2 Discrete Systems

Discrete systems are generally modelled from three components: point masses, springs and dampers. Discrete problems are solved by considering the forces applied on each mass by the other components and thus finding and solving matrix equations that link the acceleration, velocity and displacement to the external forces.

Discrete problems fall into two clear categories, namely single-degree-of-freedom (SDOF) systems and multi-degree-of-freedom (MDOF) systems. SDOF systems feature only one mass, and so result in simple, easily solvable problems. MDOF systems feature several masses, coupled in a variety of ways. MDOF systems are not covered in this publication, but further information can be found in Clough & Penzien^[4].

A typical SDOF system is a simple mass on a spring, as shown in Figure 2.1, in this case with a dashpot or viscous damper. The model in Figure 2.1 is very useful as it can be used for each mode of a continuous system (different system parameters apply to each mode) to assess the response at each natural frequency, as described in Section 2.2.4.

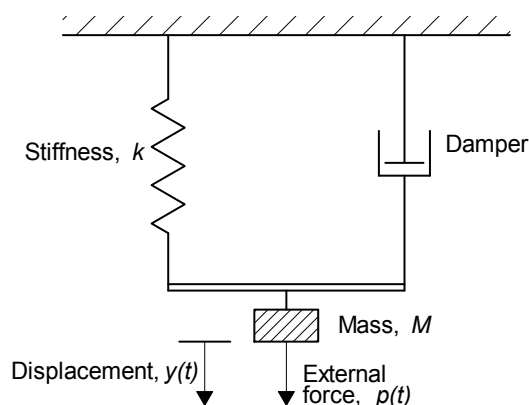

Figure 2.1 Model of a SDOF system

2.2 Frequency

The natural frequencies of a system, given either in Hz (cycles per second) or radians per second, are a measure of the rate at which the system vibrates. They are an essential part of any vibrations problem as, until the frequencies are determined, the effects of any external forces on a system cannot be predicted. For example, a load that builds and decays over 1s will cause a large reaction in a system with a frequency of 1Hz, but very little reaction in a system with a frequency of 0.01Hz (as the system will not have time to react to the load before it has disappeared) or in a system with a frequency of 100 Hz (as the load is quasi-static; i.e. it is effectively applying and removing a static load to the system).

2.2.1 Frequency Calculation

For free elastic vibration of a beam of uniform section, the frequency of the n th mode of vibration is given by solving Equation (1) to give the following result (N.B. the radial frequency $\omega_n = 2\pi f_n$):

$$f_n = \frac{\kappa_n}{2\pi} \sqrt{\frac{EI}{mL^4}} \quad (2)$$

where:

EI is dynamic flexural rigidity of the member (Nm²)

m is the effective mass (kg/m)

L is the span of the member (m)

κ_n is a constant representing the beam support conditions for the n th mode of vibration.

Some standard values of κ_n for elements with different boundary conditions are given in Table 2.1^[8].

Table 2.1 κ_n coefficients for uniform beams

Support Conditions	κ_n for mode n		
	$n = 1$	$n = 2$	$n = 3$
pinned/pinned ('simply-supported')	π^2	$4\pi^2$	$9\pi^2$
fixed both ends	22.4	61.7	121
fixed/free (cantilever)	3.52	22	61.7

A convenient method of determining the fundamental (i.e. the lowest) natural frequency of a beam f_1 (sometimes referred to as f_0), is by using the maximum deflection δ caused by the weight of a uniform mass per unit length m . For a simply-supported element subjected to a uniformly distributed load (for which $\kappa_1 = \pi^2$), this is the familiar expression:

$$\delta = \frac{5mgL^4}{384EI} \quad (3)$$

where g is the acceleration due to gravity (9.81 m/s²).

Rearranging Equation (3), and substituting the value of m and κ_1 into Equation (2) gives the following equation, in which δ is expressed in mm:

$$f_1 = \frac{17.8}{\sqrt{\delta}} \approx \frac{18}{\sqrt{\delta}} \quad (4)$$

where δ is the maximum deflection due to the self weight and any other loads that may be considered to be permanent.

It can also be easily shown that a numerator of approximately 18 would again be achieved if the above steps were repeated for a beam with different support conditions, with the appropriate equation for deflection and κ_n inserted within Equation (2). Therefore, for design, Equation (4) may be used as the generalised expression for determining the natural frequency of individual

members, even when they are not simply-supported, providing that the appropriate value of δ is used.

In addition, Dunkerly's approximation (Equation (5)) demonstrates that Equation (4) will give the fundamental natural frequency of a floor system when δ is taken as the sum of the deflections of each of the structural components (for example the primary and secondary beams and the slab),

$$\frac{1}{f_1^2} = \frac{1}{f_s^2} + \frac{1}{f_b^2} + \frac{1}{f_p^2} \quad (5)$$

where f_s , f_b and f_p are the component frequencies of the slab, secondary beam and floor beam respectively.

2.2.2 Mode Shapes

In continuous systems there will be a series of natural frequencies, each with its own mode shape. Each mode shape shows the shape of the system at maximum deflection. The fundamental (or first mode) frequency will always correspond to the simplest mode shape. The first three mode shapes of a uniform simply-supported beam are shown in Figure 2.2.

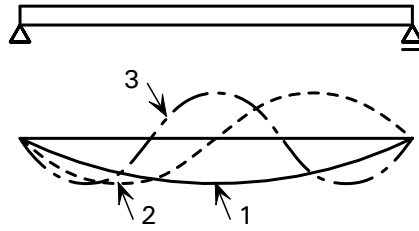

Figure 2.2 Mode shapes of a simply supported beam

Note that each mode shape is usually presented with a non-dimensional amplitude of 1 (known as unity normalised). The mode shapes of a simply-supported uniform beam are sinusoidal in form and can be expressed as follows:

$$\mu_n(x) = \sin\left(\frac{n\pi x}{L}\right) \quad n = 1, 2, 3, \dots \quad (6)$$

where:

$\mu_n(x)$ is the unity normalised amplitude at position x

L is the span of the beam

x is the position along the beam.

This shape function can be multiplied by a time-varying amplitude function, $g_n(t)$, to give the displacement of any point at any given time.

$$g_n(t) = \sin(2\pi ft) \quad (7)$$

where:

t is the time

f is the frequency of the motion.

2.2.3 Modal Superposition

In order to find the actual displacement of the system at any given time, the mode shapes will need to be superimposed. For the response to a single sinusoidal forcing function of frequency, f , this is found as follows:

$$w_n(x,t) = \sum_{n=1}^{\infty} u_n \sin(2\pi ft + \phi_n) \sin\left(\frac{n\pi x}{L}\right) \quad (8)$$

where:

$w_n(x,t)$ is the displacement at a position x along the beam at time t

t is the time

f is the frequency of the forcing function

u_n is the maximum amplitude of mode n

ϕ_n is the phase lag of mode n

u_n and ϕ_n are determined by the initial excitement or forcing function.

Methods of determining the maximum amplitude or acceleration of a floor are discussed in Section 6.

2.2.4 Modal Mass

The modal mass of a system is a measure of how much mass is involved in the mode shape, and hence how much kinetic energy there is in the system. A modal mass is determined for each mode of a continuous system so the system can be expressed as a series of SDOF discrete systems. The modal mass is found by considering the equation for the maximum kinetic energy. Note that the kinetic energy given here is dependant on the normalisation of the mode shape, and so for unity normalisation the kinetic energy will be in, for example, kg/s^2 or J/m^2 :

$$KE = \frac{1}{2} M_n v_n(t_{\max})^2 = \frac{1}{2} \int_{x_{\min}}^{x_{\max}} \int_{y_{\min}}^{y_{\max}} v_n(x,y,t_{\max})^2 m(x,y) dy dx \quad (9)$$

where:

M_n is the mass of the equivalent SDOF system for mode n

$v_n(t)$ is the velocity of the mass M_n at time t

$v_n(x,y,t)$ is the velocity of the continuous system at position (x,y) at time t

t_{\max} is the time at which the velocity is largest

$m(x,y)$ is the distributed mass of the continuous system at position (x,y) .

As $v_n(x,y,t) = \mu_n(x,y) \times g'_n(t)$ (where $g'_n(t)$ is the differential of $g_n(t)$ with respect to time), and the maximum velocity is when $g'_n(t) = 1$, Equation (9) can be simplified to:

$$M_n = \int_{x_{\min}}^{x_{\max}} \int_{y_{\min}}^{y_{\max}} \mu_n(x,y)^2 m(x,y) dy dx \quad (10)$$

The modal mass for each mode will give a direct indication on how much contribution the mode will have on the overall response of the system to an equal modal force. A large modal mass indicates that a lot of energy is required to excite the mode and so it has a small significance in the response.

2.3 Excitation

2.3.1 Continuous forcing function

The response of a system to a continuous excitation is found by determining the relevant values of u_n and ϕ_n in Equation (8), and this procedure is explained in Section 6. However, this equation is only appropriate for a single sinusoidal forcing frequency, and it is unlikely that such a simple forcing function will occur in practice. To establish the overall response, a more complicated continuous forcing function can be broken down into a series of sine waves, each of which has a frequency at an integer multiple (or harmonic) of the forcing frequency. Each harmonic will have an associated amplitude and phase shift, and the set of harmonics are known as a Fourier series. The routine for finding a Fourier series can be found in texts such as Advanced Engineering Mathematics^[9]. As an example, the first four terms of the Fourier series for the excitation force due to light aerobic activities (modelled as a series of half-sine waves) are shown in Figure 2.3.

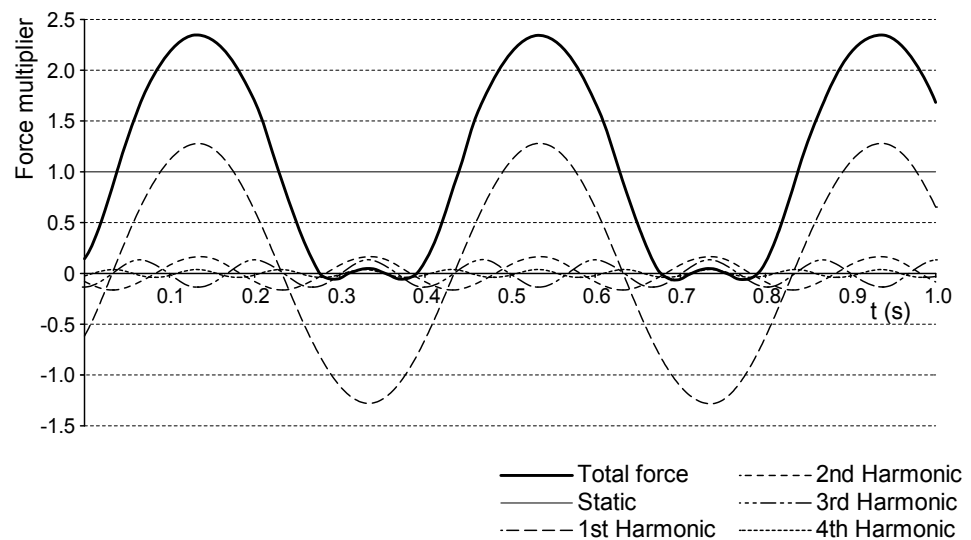

Figure 2.3 *Fourier series for low impact aerobics*

As can be seen from Figure 2.3, the amplitude of each subsequent harmonic is lower, showing that most of the energy goes into the first few harmonics. However, the resulting function does not exactly follow the half-sine wave shape (the plot should fall to, and stay at, zero between peaks) showing that, although small, energy also exists in the higher harmonic components.

2.3.2 Impulsive force

In a high frequency floor (generally defined as having a fundamental frequency greater than the fourth harmonic of walking^[10]) the response from one footstep will die away before the next, and so the forcing function will appear to be a series of separate events rather than a continuous function. These forces can be modelled using impulses. The mathematical model of a unit impulse is an infinite force over an infinitesimal time, with the multiple of force and time equal to 1. This is not physically possible, but impulses are a useful tool in vibration analysis.

2.4 Response

2.4.1 Acceleration

This publication is primarily concerned with the accelerations generated by the excitation of a system, rather than the displacements, as code-defined vibration thresholds, such as those in BS 6472^[3], ISO 10137^[2] and ANSI S3.29^[11], are generally given as accelerations (see Section 5.3).

Calculation



Acceleration is the second differential of displacement with respect to time. Hence Equation (8) can be differentiated twice to give the acceleration for a simply-supported beam as a function of position and time as follows:

$$a(x, t) = \sum_{n=1}^{\infty} -4\pi^2 f_n^2 u_n \sin(2\pi f_n t + \phi_n) \sin\left(\frac{n\pi x}{L}\right) \quad (11)$$

Root-mean-square (rms) acceleration

There are several ways to present the acceleration of a system. The most obvious is the largest, or peak, acceleration, a_{peak} . However, this gives no indication as to the amount of time the system is subjected to this level of acceleration. Instead of a_{peak} , the root-mean-square, or rms, acceleration is widely used. To illustrate this, the rms acceleration for a sine wave, a triangular wave and a square wave are shown in Table 2.2.

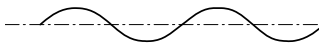
Table 2.2 Root-mean-square acceleration for various wave forms

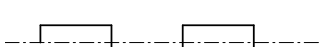
Waveform		a_{peak}	a_{rms}
	Sine	1	$1/\sqrt{2}$
	Triangular	1	$1/\sqrt{3}$
	Square	1	1

The rms acceleration is calculated as follows:

$$a_{\text{rms}} = \sqrt{\frac{1}{T} \int_0^T a(t)^2 dt} \quad (12)$$

where:

T is the period under consideration

$a(t)$ is the acceleration function

t is time.

T needs to be taken as a time period that will cover at least one complete cycle of the acceleration. For response due to walking (which has a mean frequency of 2 Hz), ISO 2631-1:1997^[12] recommends that a period of $T=1\text{s}$ be used, and refers to this as the maximum transient vibration value (MTVV).

Root-mean-quad (rmq) acceleration

Root-mean-quad, or rmq, acceleration is used in vibration dose values (see Section 6.6). This is calculated in a similar way, and gives more emphasis to the higher values of acceleration:

$$a_{\text{rmq}} = \sqrt{\frac{1}{T} \int_0^T a(t)^4 dt} \quad (13)$$

2.4.2 Damping

Damping is a general term for the removal of energy from a system, be it through dispersal or dissipation (hysteresis). Damping causes the vibration of a structure to reduce and, eventually, stop. In structures, damping is provided from friction and slip at joints and from the furniture and fixings of a room (the contents of a room will remove energy from the vibration by vibrating or moving themselves). As these factors vary between buildings and between parts of buildings, it is necessary to base design on damping values that have historically been shown to be appropriate. These damping values are given for various floors in Section 4.1.1, and are defined as the percentage of the critical damping. Critical damping is the amount of damping required to return the system to its equilibrium position without any oscillation in the minimum time.

Interruption of vibration by partitions, while not damping in itself, is usually modelled as damping to simplify the analysis. Damping can also be caused by human occupation, although a high density of occupation is necessary to have any substantial effect; this is normally ignored in design as the level of occupation cannot be guaranteed in all situations.

2.4.3 Transient and Steady State

The response of a system to regular excitation will take the form of one of the plots shown in Figure 2.4.

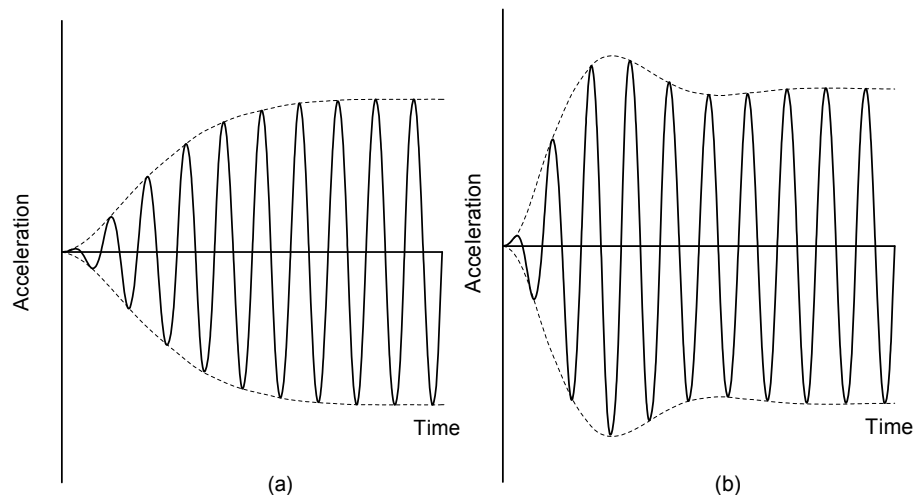

Figure 2.4 Response Envelopes

Every response can be split into two parts – the transient and the steady-state. The steady-state response is, as the name suggests, the response once the waveform has settled down. In both plots in Figure 2.4, the steady-state response is the same, and the last three complete waves are steady-state. The transient is the response before the system reaches the steady-state. In

Figure 2.4(a) the transient is less than the steady state, and so the steady-state response is more significant, but in Figure 2.4(b) the transient is greater than the steady-state.

If the frequency of the floor is high compared to the forcing frequency (for walking activities up to a maximum pace frequency of 2.5 Hz, this corresponds to greater than 10Hz), the steady-state part of the response will be insignificant compared to the transient response, and the applied force will behave more like a series of impulses than a continuous function; this response is shown in Figure 2.5

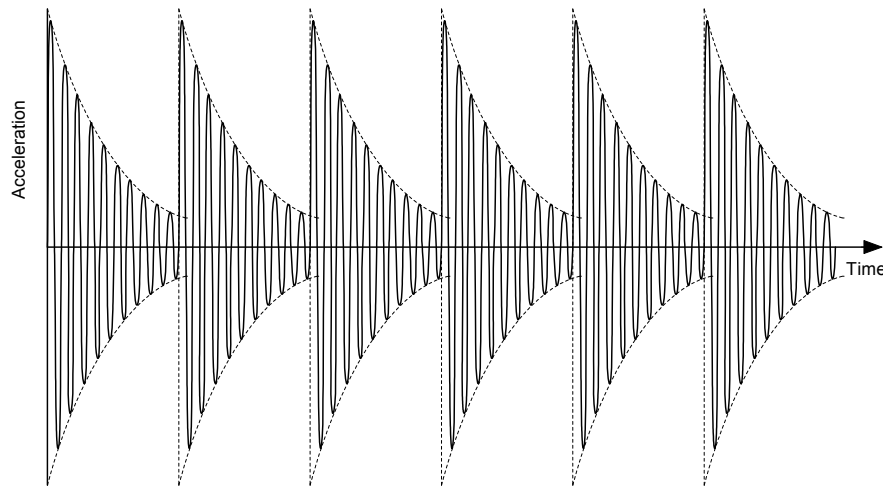

Figure 2.5 *Impulsive response*

2.4.4 Resonant and off-resonant response

The steady-state response (expressed as an rms acceleration) of a continuous system subjected to a constant cyclic force applied at a range of excitation frequencies will take a form similar to the one shown in Figure 2.6.

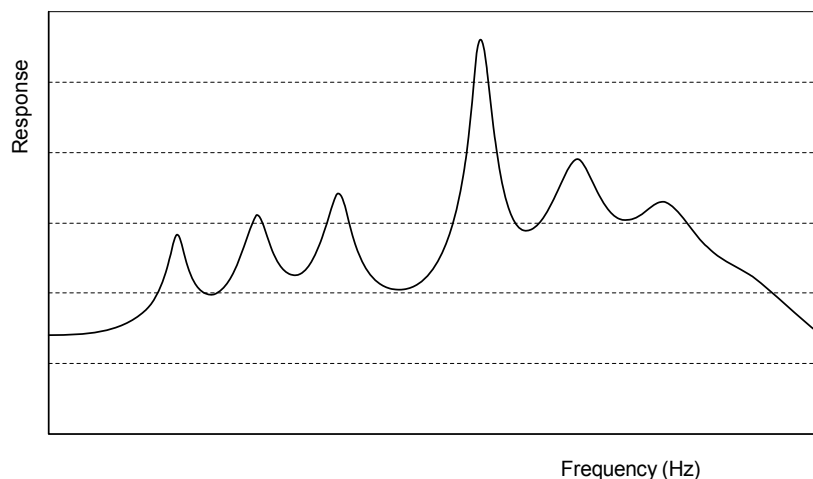

Figure 2.6 *Typical response function*

As can be seen from Figure 2.6, the function is formed of a series of peaks, and each of these peaks corresponds to a natural frequency of the system. Although the response at each natural frequency is a sharp peak in the curve (known as resonance), the response at frequencies between the natural frequencies is still significant (known as an off-resonant response). The magnitude of the response of each mode at any frequency is determined by the dynamic magnification factor, which is calculated from the forcing frequency,

the natural frequency of the mode under consideration and the damping. An expression for determining the dynamic magnification factor is given in Section 6, and this is shown graphically in Figure 2.7.

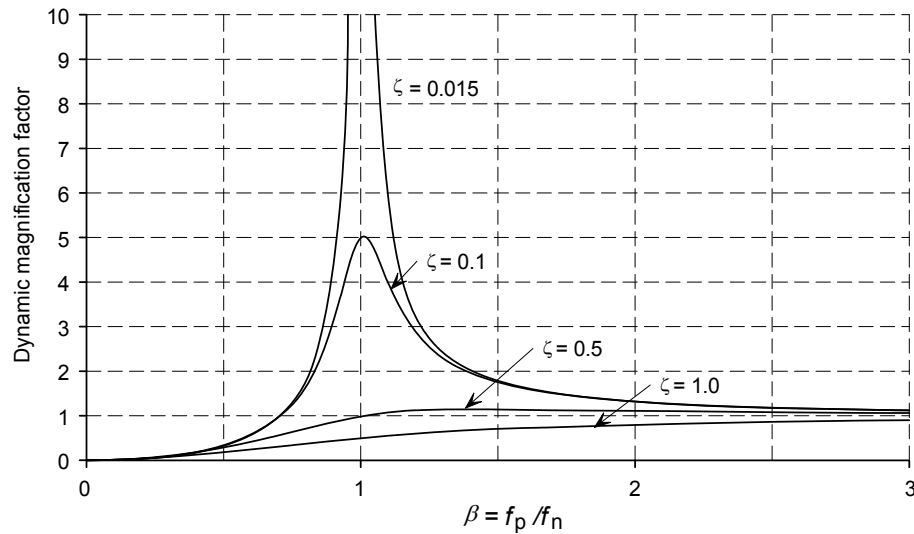

Figure 2.7 *Dynamic magnification factor for accelerations*

Figure 2.7 shows the dynamic magnification factor for a range of critical damping ratios, ζ , depending on the frequency ratio, β . The range of β of greatest importance is where the dynamic force is applied at a frequency close to the natural frequency of a structure. In any structure which is lightly damped (as is found in most practical floor systems), very large responses will occur. The condition when the frequency ratio is unity is called resonance (i.e. the frequency of the applied load equals the natural frequency of the structure; $\beta = 1$). At resonance, very large dynamic magnification factors are possible and, for undamped systems (i.e. $\zeta = 0$), the steady-state response tends towards infinity.

Since in many practical structural systems the critical damping ratio, ζ , is of the order of 1%, if precautions against resonance are not made, magnification factors of up to 50 may result. Given that the force in the structure is proportional to the displacement, the dynamic magnification factor also applies to structural forces (see Section 8.1).

Floors should be designed to have a natural frequency of over 3Hz because the fundamental harmonic of walking has a significantly larger amplitude than higher harmonics, and by making the natural frequency of the floor sufficiently high, the off-resonant vibration of the floor from this first harmonic is avoided.

3 SOURCES OF VIBRATIONS

3.1 Dynamic excitation forces

3.1.1 Walking activities

Pace frequencies

As the different harmonic components of the loading function can cause resonance with one of the natural frequencies of the floor, a vibration assessment should be carried out for a variety of pace frequencies to provide the worst-case response. Measurements of walking activities have shown that the range of possible pace frequencies that may occur is 1.5 Hz to 2.5 Hz^[13], but the range of probable pace frequencies is much narrower and, as such, the following pace frequencies should be used for design:

$$1.8\text{Hz} \leq f_p \leq 2.2\text{Hz} \quad (14)$$

The above design pace frequencies have been derived from measurements made on an office building in Delft^[14], which showed that the distribution of walking frequencies were lognormal, with a mean frequency of 2.0 Hz and a coefficient of variation of 8.5%; this has also been confirmed by Pachi & Ji^[13], but with a differentiation between male and female subjects and a lower coefficient of variation of between 6.0% and 6.9%. The design values given above have been evaluated according to Annex C of EN 1990^[15] with a target reliability index $\beta = 1.5$ and a First Order Reliability Method (FORM) sensitivity factor of $a_E = 0.7$.

Within enclosed spaces, it is felt that this range is not appropriate, as the shorter walking distances will yield slower walking speeds. As such, for spaces such as within dwellings or operating theatres, the following design pace frequency is recommended:

$$f_p = 1.8\text{Hz} \quad (15)$$

In some circumstances it is useful to know the velocity of walking at a certain frequency (see Section 6.6). Bachmann and Ammann^[16] presented a relationship between frequency and velocity that can be approximated by the following equation:

$$v = 1.67 f_p^2 - 4.83 f_p + 4.50 \quad 1.7\text{Hz} \leq f_p \leq 2.4\text{Hz} \quad (16)$$

where v is in m/s^2 .

Continuous excitation - Fourier series for walking

The forcing function from a walking activity is assumed to be perfectly periodic, and is shown in Figure 3.1:

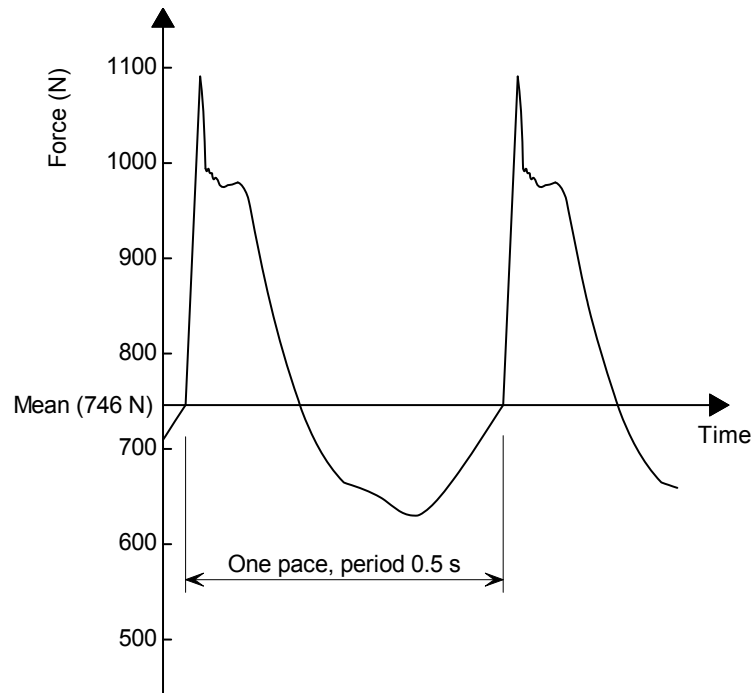

Figure 3.1 *Dynamic load function for continuous excitation due to walking*

This function can be represented by the first four harmonic components calculated from Fourier analysis. The amplitude of the harmonic force for the h^{th} harmonic, F_h , is given by:

$$F_h = \alpha_h Q \quad (17)$$

where:

α_h is the Fourier coefficient of the h^{th} harmonic (taken from Table 3.1)

Q is the static force exerted by an ‘average person’ (normally taken as $76 \text{ kg} \times 9.81 \text{ m/s}^2 = 746 \text{ N}$).

The Fourier coefficients presented in Table 3.1 may be used for steady-state design. These coefficients were derived using the same method as the evaluation of the pace frequencies by comparing the performance of the theoretical model proposed by Young^[10] with measurements^[17,18,19,20] according to the requirements given in EN 1990, Annex C.

Table 3.1 *Design Fourier coefficients for walking activities*

Harmonic h	Excitation frequency range hf_p (Hz)	Design value of coefficient α_h	Phase angle ϕ_h
1	1.8 to 2.2	$0.436(hf_p - 0.95)$	0
2	3.6 to 4.4	$0.006(hf_p + 12.3)$	$-\pi/2$
3	5.4 to 6.6	$0.007(hf_p + 5.2)$	π
4	7.2 to 8.8	$0.007(hf_p + 2.0)$	$\pi/2$

Impulsive excitation of walking

The equivalent impulsive force F_I (representing a single footfall) in Newton-seconds (Ns) that may be used in transient design is given by Equation (18). This equation was developed by comparing the performance of the theoretical model proposed by Young^[10] according to the requirements given in EN 1990 Annex C^[15].

$$F_I = 60 \frac{f_p^{1.43}}{f_n^{1.3}} \frac{Q}{700} \quad (18)$$

where:

- f_p is the pace frequency
- f_n is the frequency of the mode under consideration and
- Q is the static force exerted by an 'average person' (normally taken as $76 \text{ kg} \times 9.81 \text{ m/s}^2 = 746 \text{ N}$).

3.1.2 Staircases

According to Appendix A of ISO 10137^[2], the human-induced footfall loading on stairs during ascending and descending is significantly different in magnitude and frequency compared to the forces induced by walking on flat surfaces. The staircase loads are generally much higher and it is normal to expect a fast descent of a staircase to be made at pace frequencies of around 3 to 4 Hz, with rates of 4.5 Hz also quite possible. This compares with normal walking, which has maximum possible range from 1.5 to 2.5 Hz. It is assumed that only the first two harmonics of dynamic loads induced on stairs need to be taken into account and their design values^[2] and frequency ranges over which they are assumed to be constant are given in Table 3.2.

Table 3.2 *Design Fourier coefficients for staircases from ISO 10137^[2]*

Harmonic h	Frequency range hf_p (Hz)	Design value of coefficient α_h
1	1.2 Hz to 4.5 Hz	1.1
2	2.4 Hz to 9 Hz	0.22

3.1.3 Synchronised crowd activities

This Section is intended to give guidance for dance and aerobic areas. Detailed guidance for stadia can be found in a forthcoming publication from The Institution of Structural Engineers.

Activity frequencies

Where floors are likely to be subject to rhythmic activities characterised by synchronised movement of multiple participants (e.g. dancing, aerobics, etc.), Ji and Ellis^[21] recommend that the anticipated dynamic loading should be calculated for the following activity frequency ranges:

Individuals = 1.5 – 3.5 Hz

Groups = 1.5 – 2.8 Hz

These frequency ranges cover the increased activity level due to jumping, which is the worst case situation with crowd loading. The lower frequency range for groups is due to the fact that the higher frequencies can rarely be sustained by a crowd.

Applied loading density

It is recommended by Bachmann and Ammann^[16] that the crowd density for rhythmic activities should be taken to be:

- Aerobic and gymnasium activities = 0.25 persons/m²
- Social dancing activities = 2.00 persons/m²

Fourier series for rhythmic activities

The load-time history can be modelled as a high contact force for a certain period of time (the contact period) followed by zero force when the feet leave the floor. It has been proposed that the load-time function can be expressed by a sequence of semi-sinusoidal pulses; this aligns well with measurements for individuals jumping^[22]. The force transferred is characterised by the contact ratio, α_c , which is defined by the duration of contact with the floor divided by the period for the activity. Different contact ratios characterise different rhythmic activities and the lower the value of the contact ratio, the more vigorous the activity. The peak dynamic load may be several times greater than the static load.

For analysis, the load function may be expressed as a Fourier series as follows:

$$F(t) = q \left\{ 1.0 + \sum_{h=1}^H \alpha_h \sin [2 h \pi f_p t + \phi_h] \right\} \tag{19}$$

where:

- q is the weight of the jumpers (usually taken as 746 N per individual)
- H is the number of Fourier terms
- α_h is the Fourier coefficient (or dynamic load factor) of the h^{th} term
- f_p is the frequency of the jumping load
- ϕ_h is the phase lag of the h^{th} term

Unless more accurate information is available, the Fourier coefficients and phase lags given in Table 3.3 should be used for design^[22].

Table 3.3 *Fourier coefficients and phase lags for different contact ratios*

		<i>Fourier coefficient and phase lag for h^{th} harmonic</i>						
			$h = 1$	$h = 2$	$h = 3$	$h = 4$	$h = 5$	$h = 6$
$\alpha_c = 2/3$	Low impact	α_h	9/7	9/55	2/15	9/247	9/391	2/36
	aerobics	ϕ_h	$-\pi/6$	$-5\pi/6$	$-\pi/2$	$-\pi/6$	$-5\pi/6$	$-\pi/2$
$\alpha_c = 1/2$	High impact	α_h	$\pi/2$	2/3	0	2/15	0	2/35
	aerobics	ϕ_h	0	$-\pi/2$	0	$-\pi/2$	0	$-\pi/2$
$\alpha_c = 1/3$	Normal	α_h	9/5	9/7	2/3	9/55	9/91	2/15
	jumping	ϕ_h	$\pi/6$	$-\pi/6$	$-\pi/2$	$-5\pi/6$	$-\pi/6$	$-\pi/2$

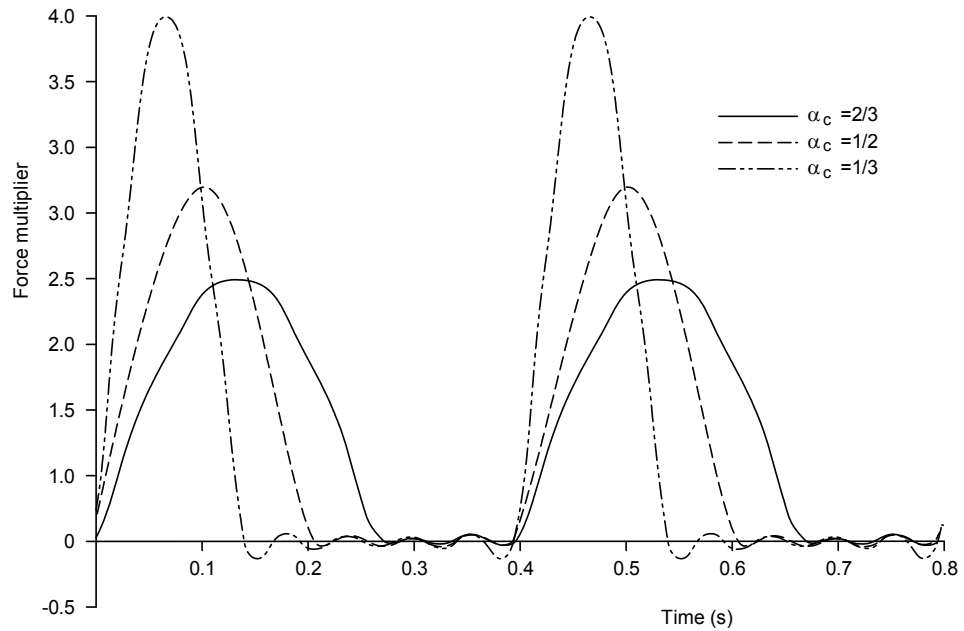

Figure 3.2 Loading for synchronised activities with various contact ratios

For ultimate limit state considerations, only the first three harmonic components need to be considered. According to BS 6399-1^[23], if the floor frequency is greater than 8.4 Hz, the floor may be considered to be insensitive to resonant effects. However, for a floor frequency less than this value the floor should be designed to resist the anticipated dynamic loads, which should be considered as an additional imposed load case (with $\gamma_f = 1.0$). This loading should also be considered as an additional variable action according to the Eurocodes

The Fourier coefficients given in Table 3.3 are appropriate for small groups of individuals engaged in rhythmic activities. However, for large groups, the lack of coordination between participants can lead to lower Fourier coefficients. To reflect this lack of coordination the first three Fourier coefficients in Table 3.3 may be replaced by the following^[22], used in conjunction with the phase angles presented in Table 3.3 for “Normal jumping”:

$$\left. \begin{aligned} \alpha_1 &= 1.61p^{-0.082} \\ \alpha_2 &= 0.94p^{-0.24} \\ \alpha_3 &= 0.44p^{-0.31} \end{aligned} \right\} (20)$$

Where p is the number of participants in the rhythmic activity ($2 \leq p \leq 64$). Equation (20) is shown graphically in Figure 3.3.

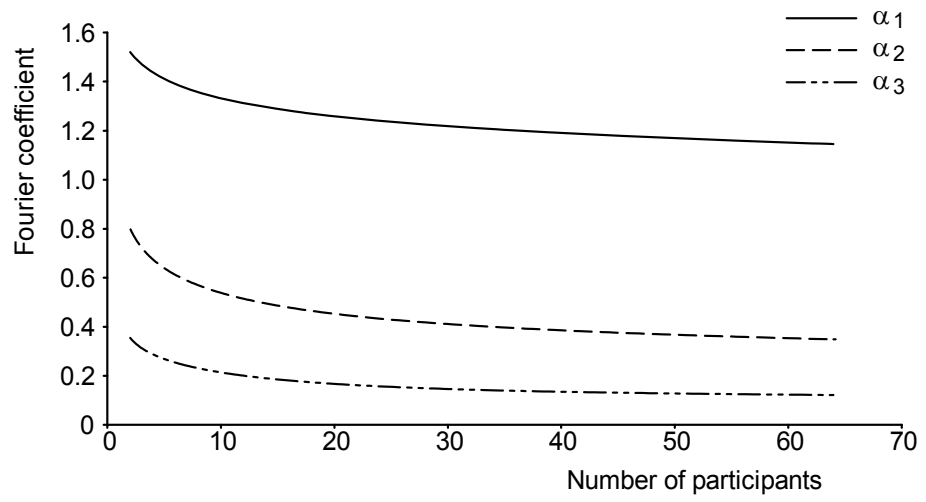

Figure 3.3 *First three Fourier coefficients versus group size.*

4 DESIGN CONSIDERATIONS FOR FLOORS

4.1 Structural considerations

Problems caused by vibration in buildings are often due to the nature of the structural solution employed, and so vibration design is a fundamental part of structural design. Potential problems are best dealt with and accounted for at an early design stage. The main purpose of considering vibrations at the early stages of structural design is to enable the engineer to make good choices for the project, which will help to provide the best structural solution and avoid the need for expensive remedial work.

4.1.1 Damping

An explanation of damping is given in Section 2.4.2. In practice, the following critical damping ratios, ζ , are likely to be achieved in typical steel framed buildings. These values should be used in design unless more accurate information is available:

Table 4.1 *Critical damping ratios for various floor types*

ζ	Floor finishes
0.5%	for fully welded steel structures, e.g. staircases
1.1%	for completely bare floors or floors where only a small amount of furnishings are present.
3.0%	for fully fitted out and furnished floors in normal use.
4.5%	for a floor where the designer is confident that partitions will be appropriately located to interrupt the relevant mode(s) of vibration (i.e. the partition lines are perpendicular to the main vibrating elements of the critical mode shape).

Although the damping values for completely bare floors are not used regularly (mainly because the floor would not be in this state when the building is occupied), it may be useful for the engineer to assess the performance in this condition, as adverse comments could be raised over the acceptability of a floor before the building is completely fitted-out.

4.1.2 Floor loading

It is important that the distributed mass used in vibration analysis is representative of the mass that will be present in service, as a higher mass will reduce the response of a floor at a given frequency. In design, the mass per unit area should be taken as the unfactored self-weight of the structure including superimposed dead loads such as the weight of ceilings and services (unless the analysis is being conducted for a bare-state structure, in which case all superimposed dead loads should be ignored). In addition, where the designer can be confident that such loading will be guaranteed to exist in the finished structure, an additional allowance may be included for semi-permanent loads (this loading should not be included for dance or aerobic floors).

According to the UK National Annex to EN 1990^[15], 30% of the imposed load should be included when considering deformation at serviceability limit state

(i.e. under the quasi-permanent combination, $\psi_2 = 0.3$ for offices and residential buildings). This magnitude would appear to be an inappropriate allowance for floor vibrations because the requirement for flexibility in use of many modern constructions and the move to increasingly paperless environments has resulted in the actual imposed load being considerably less than the prescribed design loads on the floor. This discrepancy between design imposed loads and *in situ* loads in service means that it is advisable to consider only the imposed loads which may be reasonably assumed to be permanent during building use. Indeed, imposed loads may be ignored completely as a conservative design scenario. According to Hicks *et al.* [24], it is recommended that the allowance should not exceed 10% of the nominal imposed load.

4.1.3 Dynamic value modulus of elasticity for concrete

Calculation of the natural frequency should be based on the dynamic value of the modulus of elasticity for the concrete; this may be taken to be 38 kN/mm² for normal weight concrete, and 22 kN/mm² for lightweight concrete (dry density of approximately 2350 kg/m³ and 1800 kg/m³ respectively).

4.1.4 Structural and floor configurations

Steel-concrete composite construction

Composite construction uses steel beams and concrete composite floor slabs joined by shear connectors. Composite action develops between the steel secondary (or floor) beams and the concrete through the longitudinal force being transferred by the shear connectors. The secondary or floor beams themselves will be framed into primary (or main) beams that form part of the principal structural framing of the building.

It should be noted that the deflection and stress levels in a tolerable dynamic response are low, with typical dynamic stress amplitudes due to vibration being less than 1% of the static design stress. At such low stress levels, the normal assumption that beams and slabs are simply-supported is not necessarily valid. Generally there is insufficient strains to overcome friction, and so the beams act as if they are structurally continuous even when not designed statically to be so.

Cantilevers

Although cantilever forms of construction are relatively uncommon, the methods presented in Section 2.2.1 for evaluating natural frequencies are broadly applicable. However, as there is a rather ineffective mobilisation of mass if dynamic excitation is applied near the free end of the cantilever, the evaluation of response using the simplified rules in Section 7 may be non-conservative. It is suggested that the general procedure in Section 6 be used in such circumstances.

Light steel frame floors

The use of light steel framing and modular construction has increased dramatically over the past ten years. Currently, the most popular use for light steel floor construction is in residential buildings. Much of the design guidance given in this publication, for this type of floor, is directly related to such use.

For the purpose of this guide, light steel floors are considered to be constructed from support members that possess a second moment of area less than, or equal to 450 cm⁴, with floor boarding comprising timber boards, chipboard, plywood or cement particle board. The natural frequency of the system should be in the

high frequency range (i.e. f_1 greater than or equal to 8 Hz within dwellings and f_1 greater than or equal to 10 Hz for corridors); as such, the floors will be dominated by the impulsive response to walking forces (see Section 2.4.3).

Small floors with no internal columns

In some instances, floors may be small or so structurally simple that they will behave more like a plate than a system of floor elements. Typically, such floors are characterised by buildings with no internal columns and with the floor beams spanning between columns within the building façades. In these cases the dynamic properties of the floor may be estimated from Young and Budynas^[8].

4.1.5 Continuity and isolation of critical areas

The response of the floor depends on the amount of the mass that participates in the dynamic movement. To a large extent, the floor response may be influenced by taking measures to control the extent of the participative area. The measures generally fall into two categories: one is to utilise the largest participative area by way of floor plate continuity; the second is to isolate the participative area from locations where the vibration performance is being considered.

Utilising continuity

A floor which has not been designed to be continuous for strength may act as such for dynamic conditions. If a floor plate is continuous over a beam, or if the beam (or another structural element) provides continuity, the floor plates can generally be considered continuous for dynamic performance. In addition, strength considerations can also affect the dynamic performance of the floor; for example, for composite beam applications, care must be taken that transverse reinforcement is provided, as its absence can lead to the vibration performance degrading over time as cracks form and continuity drops. Where there is no continuity, the floor plate should be treated as independent simply-supported slabs, which will have the effect of making participating areas small and therefore likely to exhibit a greater response.

Isolating Floor areas

Continuity can have a negative consequence, as it may cause areas of the floor to participate in movement, beyond acceptable levels, due to activities on another part of the continuous floor. Where a clear transmission path exists in a building, it is possible, in some cases, to isolate the area where the activity is taking place from the area which would otherwise be likely to experience an unacceptable response level.

To isolate a floor plate, the area must be structurally separated from the rest of the floor (e.g. by provision of construction joints all around the edges). This will mean that the activity is unable to transfer any vibration to the area. This technique is particularly appropriate for rooms such as operating theatres, where vibration in the room caused by activity externally is a cause for concern and the response limits are severely low.

An alternative isolation technique is to increase the stiffness of the floor locally. The benefit is that the sensitive area may be controlled without having to alter the design for the rest of the floor. This has the effect of isolating the area from the rest of the floor. Usually this means that the stiffer floor area will

have a deeper form of construction and this should be considered in the design for headroom and services requirements.

4.1.6 Precast concrete units in composite design

Precast units with an in-situ concrete topping and supplementary continuity reinforcement will behave in a similar manner to a metal decking composite floor system if connected to the supporting beams through shear connectors, or if trapped between the flanges of the beams (i.e. slim floor construction and shelf-angle beams^[25]). However, if shear connectors are not provided to the supporting beams, the area that may be considered to participate in the motion in Section 7 should correspond to half the beam span multiplied by half the beam spacing. This form of construction therefore, through lack of stiffness, contributes only by virtue of its mass to the vibration characteristics of the floor as a whole.

If a structural topping is not provided to the precast units, the designer should be aware that there may be a danger that the units could vibrate independently from one another, which can result in a high response, owing to a relatively low effective mass participating in the motion.

4.2 Architectural considerations

4.2.1 Walking paths

Some areas of a floor will have a higher response than others due to the mode shapes of the vibration. Generally, areas close to beams and columns will be less responsive than areas in the middle of a slab as these form nodal lines (i.e. limited or no motion). By locating walking paths closer to these less responsive areas, many vibration issues may be eliminated.

In addition to location, the length of the corridor should be considered. The longer the corridor, the more time is associated with the walking activity and a subsequent higher dose of vibration will be transmitted to other floor areas. Reducing corridor lengths or breaking-up the corridor length into several lengths reduces the duration of any given walking activity. This is helpful when considering the VDV method of floor assessment (see Section 6.6).

4.2.2 Distribution of floor loading

As stated in Section 4.1.2, care should be taken when allowing for any imposed loads in the calculation of the floor response. Uniformly distributed loading may not be appropriate for design and so consideration should be given to the location of loading on the final floor. Although an overall load may be expected reasonably to exist, there may be some areas (e.g. storage areas) that have more load than others. Where floor loading is concentrated more heavily in certain areas than others then the heavier load can be used to calculate the natural frequencies and the lighter load used to calculate the response. This will give a conservative design value, though if the exact distribution can be used (in finite element analysis, for example) then the results will be less conservative.

4.2.3 Relative positioning of aerobic and non-aerobic areas

Aerobic areas are, by their very nature, likely to result in high response values. Due to continuity of the floor for dynamic conditions, this response may be transmitted into other areas of the floor. It is therefore advisable to take care when positioning aerobic areas to ensure that the affected floor locations do not

exhibit a response that would be considered unacceptable. Ideally, office, residential and other communal locations should not be placed close to areas where rhythmic activities are likely to take place.

Similarly, because of possible transfer of force, the vertical placement of aerobic areas needs to be considered. Rhythmic activities cause considerable vibration and therefore subsequently high deflections and accelerations. The effect of this situation should be considered on rooms above and below the relevant floor areas, and the vertical location of the aerobic area carefully considered. Where possible, areas used for rhythmic activities should be as low as possible in the building, if feasible on the ground floor or in the basement.

5 ACCEPTABILITY OF VIBRATIONS

5.1 Considerations

5.1.1 Serviceability Issues

Generally, vibration of floors is considered to be a serviceability issue, primarily related to discomfort, although vibration can also cause minor damage or cracks and can affect sensitive equipment. However, discomfort cannot be directly quantified or scaled. As perception and discomfort vary between humans, no exact limit can be imposed that will guarantee that the floor response will not give rise to adverse comments from occupants throughout its lifetime of use. Instead of absolute solutions, current standards seek to guide designers toward solutions which will attract ‘a low probability’ of adverse comment.

Current standards^[2,3,11] describe human discomfort in terms of the perceived acceleration of the floor; floor suitability (in relation to vibration) is assessed by comparing the predicted acceleration with a set of defined acceptance criteria. Personal discomfort is realised to a different degree for a person sitting at an office desk, for someone operating a machine or for a spectator watching sport, and this is recognised in the Standards by applying multiplying factors to the acceptance criteria for different situations.

5.1.2 Strength Issues

Human activity in buildings, being temporary in nature, causes dynamic deformations and stresses in the structural members. Occasionally, application of vibration-inducing forces may also cause fatigue or overstress in principal load-bearing members. In these circumstances the dynamic loads can exceed the static load considered in the design of the structure and, as such, should be considered as an additional imposed load design case. BS 6399-1^[23] provides current requirements for the structural adequacy of buildings subject to dynamic activities (see Section 3.1.3 and Section 8.1.2).

5.2 Human perception

5.2.1 Continuous vibrations

There are many possible ways in which the magnitude of the vibration response can be measured. For large-amplitude, low frequency motion, it may be possible to observe the displacement between the maximum (i.e. peak) movement in one direction, and the peak movement in the opposite direction (i.e. the peak-to-peak displacement). In practice, this distance can be difficult to measure and, for high frequency motion, the vibration can be severe even when the displacement is too small to be detected by the eye. The velocity, which is more directly related to the energy involved in the structural movement, may also be used to define the magnitude of the vibration. However, instrumentation for measuring acceleration is normally more convenient. As a consequence of this, many modern standards describe the severity of human exposure to vibration in terms of rms acceleration rather than velocity or displacement (see Section 2.4.1). An rms acceleration is used rather than peak acceleration because it gives a better indication of the vibration over time, and sharp peaks in an otherwise low response are then less significant.

The base value of acceleration that can be perceived depends on the direction of incidence to the human body, and for this the basicentric coordinate system shown in Figure 5.1 is used (the z-axis corresponds to the direction of the human spine). The base value is higher for z-axis vibration than for x- or y-axis vibration (i.e. x- or y-axis vibration is more easily perceived).

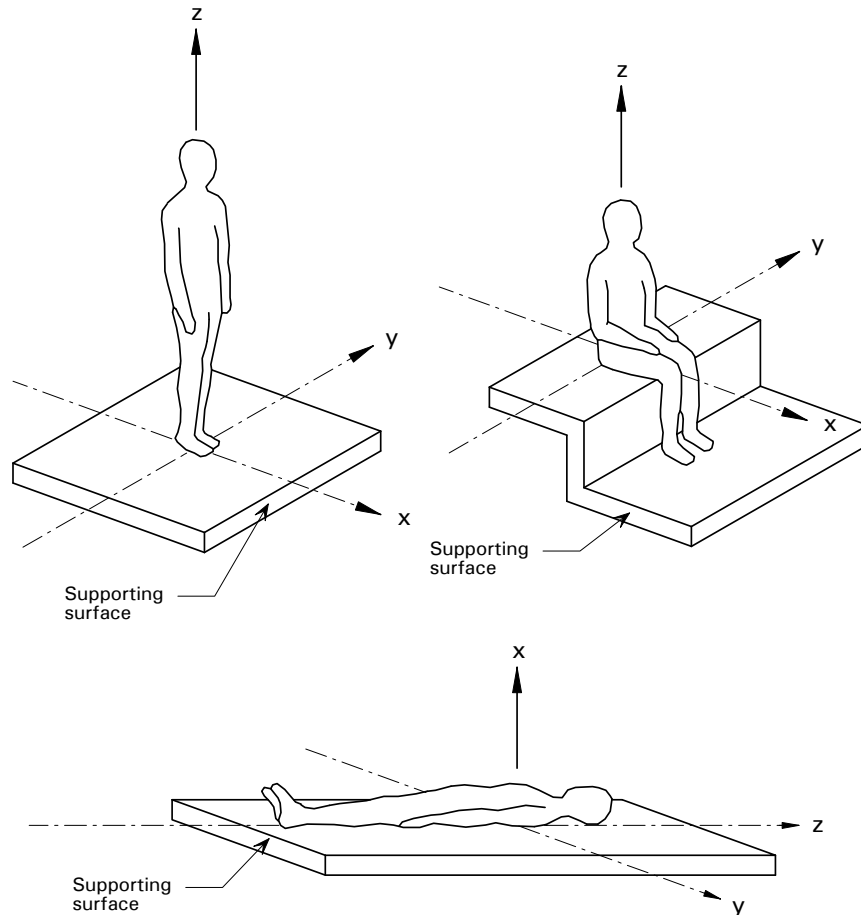

Figure 5.1 *Directions for Vibration defined in ISO 2631^[12,26], BS 6472^[3] and BS 6841^[27]*

The perception of vibration also depends on the frequency. This is because the human body's sensitivity to a given amplitude of vibration changes with the frequency of the vibration. This is much the same phenomenon as in dog whistles; although the volume (amplitude) of a normal whistle and a dog whistle may be the same, a human will not be able to perceive (in this case hear) the dog whistle because the high frequency of the output is such that the ear is not sensitive to it. Whole body vibration is similar; the body has a variable range of maximum sensitivity. The variation of sensitivity can be taken into account either by attenuating the calculated response (for frequencies where perception is less sensitive) or by enhancing the base value. The degree to which acceleration is attenuated or enhanced is referred to as "frequency weighting".

5.2.2 Frequency weighting

Values of frequency weighting are given in BS 6841^[27] and ISO 2631^[12,26]. Various weighting curves are given, depending on the direction of vibration and the activity; the three most common are shown graphically in Figure 5.2 and Figure 5.3 and are simplified (asymptotic) versions of the curves in BS 6841. Table 5.1 provides guidance on when each curve applies.

Weighting Categories

In most cases, the aim of vibration analysis is to reduce or remove discomfort, but in special circumstances, such as operating theatres, the level of vibration will need to be such that it cannot be perceived and does not affect the steadiness of hand or vision. Perception and discomfort use the same weightings but typically perception will have a lower allowable threshold (i.e. a subject can detect vibration without being discomforted by it).

Table 5.1 *Weighting factors appropriate for floor design*

Room Type	Axis of vibration	Category	BS 6841 weighting curve
Critical working areas (e.g. hospital operating theatres, precision laboratories)	z-axis	Vision/Hand control	W_g
	x-, y-axis	Perception	W_d
Residential, offices, wards, general laboratories, consulting rooms	z-axis	Discomfort	W_b
	x-, y-axis	Discomfort	W_d
Workshop and circulation spaces	z-axis	Discomfort	W_b
	x-, y-axis	Discomfort	W_d

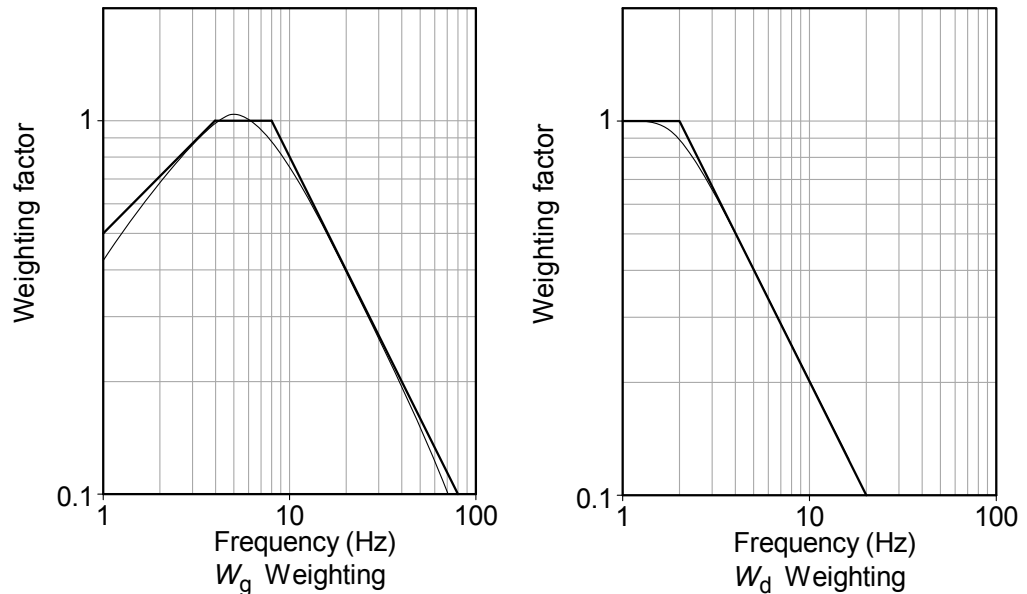

Figure 5.2 W_g and W_d frequency weighting curves (BS 6841)

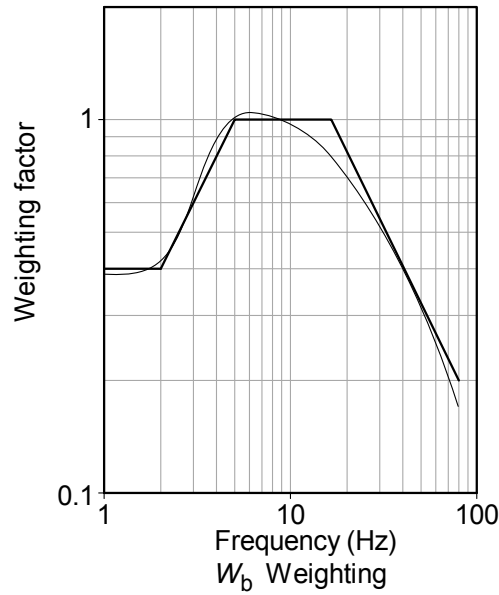

Figure 5.3 W_b frequency weighting curve (BS 6841)

To illustrate the use of the curves, for z-axis vibration using curve W_b for discomfort, a sine wave of 8 Hz has the same feel as a sine wave at 2.5 Hz or 32 Hz with double the amplitude.

The curves presented in Figure 5.2 and Figure 5.3 can also be expressed by the following equations:

z-axis vibrations W_g weighting

$$\begin{array}{ll}
 W = 0.5\sqrt{f} & \text{for } 1 \text{ Hz} < f < 4 \text{ Hz} \\
 W = 1.0 & \text{for } 4 \text{ Hz} \leq f \leq 8 \text{ Hz} \\
 W = \frac{8}{f} & \text{for } f > 8 \text{ Hz}
 \end{array} \quad \left. \vphantom{\begin{array}{l} \\ \\ \end{array}} \right\} (21)$$

z-axis vibrations W_b weighting

$$\begin{array}{ll}
 W = 0.4 & \text{for } 1 \text{ Hz} < f < 2 \text{ Hz} \\
 W = \frac{f}{5} & \text{for } 2 \text{ Hz} \leq f < 5 \text{ Hz} \\
 W = 1.0 & \text{for } 5 \text{ Hz} \leq f \leq 16 \text{ Hz} \\
 W = \frac{16}{f} & \text{for } f > 16 \text{ Hz}
 \end{array} \quad \left. \vphantom{\begin{array}{l} \\ \\ \\ \end{array}} \right\} (22)$$

x- and y-axis vibrations W_d weighting

$$\begin{array}{ll}
 W = 1.0 & \text{for } 1 \text{ Hz} < f < 2 \text{ Hz} \\
 W = \frac{2}{f} & \text{for } f \geq 2 \text{ Hz}
 \end{array} \quad (23)$$

5.2.3 Intermittent vibrations

Generally, walking activities are not continuous; by their nature they are intermittent. For intermittent vibrations, a cumulative measure of the response has been found to be more reliable in determining perceptive tolerance levels^[28]. BS 6472^[3] and ISO 10137^[2] give guidance on intermittent vibrations through vibration dose values (VDVs), which describe the perception levels due occasional short-duration vibrations. This allows the vibration levels to be higher than the thresholds for continuous vibrations as long as the occurrence is rare. The general expression for calculating VDVs is shown below (a full explanation of the approach is given in Section 6.6):

$$VDV = \left(\int_0^T a_w(t)^4 dt \right)^{1/4} \quad (24)$$

where:

VDV is the vibration dose value (in $m/s^{1.75}$)

$a_w(t)$ is the weighted acceleration (expressed in m/s^2)

T is the total period of the day during which vibration may occur (expressed in seconds).

BS 6472 provides guidance for values of VDV above which various degrees of adverse comment may be expected in residential buildings for both day- and night-time exposure. This is discussed further in Section 5.3.3.

Although it has been acknowledged^[28] that the VDV approach is a more reliable measure of vibration response, it is not widely used in the design of floors due to the fact that the location of walking corridors are often not known in the early design stage, and it is normally required that there is some flexibility in the floor layout. Most modern design guides therefore conservatively assume that walking activities produce continuous vibrations on floors. On very sensitive floors (such as operating theatres and precision laboratories), some guidelines^[29,30] do not make allowance for the intermittency of events; there are no VDV values in BS 6472 for such floors.

The VDV approach offers improved understanding of the likely acceptability of floors for vibrations. Cooperation between all involved in the design process (including architect, client and engineer) to determine the likely use and frequency of use of the floor may allow the approach to be utilised as a benefit to the overall design process for a wide variety of structures.

5.3 Acceptance criteria

5.3.1 Acceptance thresholds

A great deal of research has been carried out to assess the effect of human response to vibration, which is reflected in international standards on human exposure to vibrations^[2,3,11,12,31,32,26]. In the United Kingdom, the appropriate standard is BS 6472^[3]. This Standard covers many vibration environments in buildings and, to achieve this wide coverage, limits of satisfactory vibration magnitude are expressed in relation to a frequency-weighted 'base curve' and a series of multiplying factors.

The base curves for vibration in the z-axis and x-, y-axis directions are derived from the following base values:

- $a_{\text{rms}} = 5 \times 10^{-3} \text{ m/s}^2$ for z -axis vibrations
- $a_{\text{rms}} = 3.57 \times 10^{-3} \text{ m/s}^2$ for x - and y -axis vibrations

These base values are used with the W_g and W_d weighting factors to give the base curves shown in Figure 5.4. The lines represent a constant level of human perception known as an isoperceptability line. The area above the line corresponds to an increasing level of human perception of the vibration; the area below the line represents vibration that is imperceptible to humans.

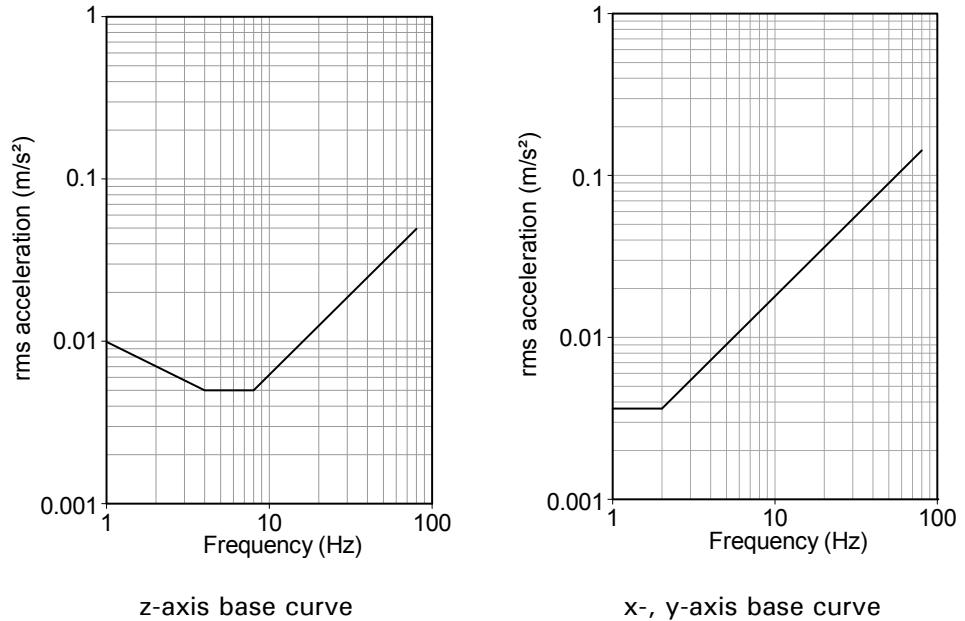

Figure 5.4 Base curves for perception of vibration, taken from BS 6472

In practice, these base curves are rarely used, because they relate to only a single frequency response. Instead, calculated accelerations for the floor are attenuated by the frequency weighting (as shown in Figure 5.2 and Figure 5.3), using factors appropriate to the frequency of the mode considered (see Section 6.3).

5.3.2 Continuous vibrations

Continuous vibrations are uncommon, and are representative of the worst possible loading scenario for a given forcing function. This means that they provide a conservative design scenario (which may be useful in carrying out quick estimates of the floor response).

Table 5 of BS 6472 and Table C.1 of ISO 10137^[2] provide multiplying factors to the base curves for continuous vibrations, which correspond to a 'low probability of adverse comment'. These factors are presented in Table 5.2.

Table 5.2 *Multiplying factors specified in BS 6472 for ‘low probability of adverse comment’*

Place	Time	Multiplying factor for exposure to continuous vibration 16 h day 8 h night	Impulsive vibration excitation with up to 3 occurrences
Critical working areas (e.g., hospital operating theatres)	Day	1	1
	Night	1	1
Residential	Day	2 to 4	60 to 90
	Night	1.4	20
Office	Day	4	128
	Night	4	128
Workshops	Day	8	128
	Night	8	128

In practice, these multiplying factors are used as limits to the value of calculated response factors, where the response factor is defined as the calculated weighted rms acceleration divided by the appropriate base value – see Section 6.5.3. Different multiplying factors are defined in HTM 08-01^[29] for use within hospital environments. Further information on these is given in Section 8.2.

In 1989, SCI proposed^[33] a series of multiplying factors that, in some environments, are larger than those presented in Table 5.2; similar values have also been recommended by the AISC/CISC DG11^[34]. To the authors’ knowledge, no adverse comments have been received from occupants on floors designed to those factors. It is therefore suggested that a multiplying factor of 8 is used for offices. This and supplementary values are presented in Table 5.3, and may be used for design.

Table 5.3 *Recommended multiplying factors based on single person excitation*

Place	Multiplying factor for exposure to continuous vibration
Office	8
Shopping mall	4 ^[35]
Dealing floor	4
Stairs – Light use (e.g. offices)	32 ^[58]
Stairs – Heavy use (e.g. public buildings, stadia)	24 ^[58]

5.3.3 Intermittent vibrations

BS 6472 gives guidance on calculating estimated vibration dose values (VDVs) in order to determine the acceptance level of intermittent vibrations and gives limits for acceptable response (see Table 5.4). However, this guidance assumes a purely sinusoidal response for estimating VDVs and so is unsuitable for walking activities^[28], although the limits still apply. This publication presents a method of calculating VDVs based on a study by Ellis^[36], and this can be found in Section 6.6.

Table 5.4 *Vibration dose value limits ($m/s^{1.75}$) for z-axis vibration specified by BS 6472*

Place	Low probability of adverse comment	Adverse comment possible	Adverse comment probable
buildings 16 h day	0.2 to 0.4	0.4 to 0.8	0.8 to 1.6
buildings 8 h night	0.13	0.26	0.51

5.3.4 Rhythmic activities and stadia

Dynamic crowd loads are generated by the movement of people. The largest loads are produced by synchronised rhythmic movements which mainly arise from people dancing or jumping, usually in response to music. A crowd of people jumping rhythmically can generate large loads and this may be of concern for both safety and serviceability evaluations.

There is no generally agreed acceptance criterion for structures of this type. Guidance is offered by the AISC^[34] which recommends that 4 to 7% gravity is a recommended peak acceleration limit for vibration due to rhythmic activities; this is equivalent to a multiplying factor of 55 to 97. Recent test evidence suggests that a response factor of 120 is acceptable for dance floors in nightclubs, where the loud music and low lighting will reduce the perception and vision. From tests on grandstands^[22], this level of response has been described as ‘disturbing’ (see Table 5.5). However, it should be noted that the values in Table 5.5 were derived from tests where less extreme levels of sound and light were imposed on the crowd.

Table 5.5 *Reaction to various acceleration levels on grandstands in terms of the acceleration due to gravity, g ($= 9.81 m/s^2$)*

rms acceleration % g	Equivalent response factor, R	Reaction
< 3.5	< 69.4	Reasonable limit for passive persons
< 12.7	< 249.7	Disturbing
< 24.7	< 342.7	Unacceptable
> 24.7	> 342.7	Probably causing panic

5.4 Sensitive Processes

As well as the human response to vibration, there may be cases where the vibration response will need to be limited for sensitive equipment, such as microscopes. Vibration limits for sensitive equipment are generally given in terms of velocity, but Table 5.6 shows equivalent response factors, and their corresponding BBN^[37] and ASHRAE^[38] criteria, that may be used for initial design. The limits given in Table 5.2 are included for comparison. Specialist advice should be sought from the equipment manufacturers for final design of floors where the level of response is critical.

Table 5.6 *Guideline multiplying factors for sensitive processes from Pratt^[39]*

Place/BBN curve	Multiplying Factor	ASHRAE	BBN	Detail size [†]	Description of use
Workshop	8 [‡]	J	-	N/A	Distinctly perceptible vibration. Appropriate to workshops and non-sensitive areas.
Office	4 [‡]	I	-	N/A	Perceptible vibration. Appropriate to offices and non-sensitive areas.
Residential day	2 [‡]	H	-	75µm	Barely perceptible vibration. Appropriate to sleeping areas in most instances. Probably adequate for computer equipment, probe test equipment and low-power (to 20 ×) microscopes.
Operating theatre	1 [‡]	F	-	25µm	Threshold of perception. Suitable for sensitive sleeping areas. Suitable in most instances for microscopes to 100 × and for other equipment of low sensitivity.
VC-A	0.5	E	A	8µm	Adequate in most instances for optical microscopes to 400 ×, microbalances, optical balances, proximity and projection aligners, etc.
VC-B	0.25	D	B	3µm	An approximate standard for optical microscopes to 1000 ×, inspection and lithography equipment (including steppers) to 3-micron line widths.
VC-C	0.125	C	C	1µm	A good standard for most lithography and inspection equipment to 1-micron detail size.
VC-D	0.625	B	D	0.3µm	Suitable in most instances for the most demanding equipment including electron microscopes (TEMs and SEMs) and E-beam systems, operating to the limits of their capability.
VC-E	0.0313	A	E	0.1µm	A difficult criterion to achieve in most instances. Assumed to be adequate for the most demanding of sensitive systems including long path, laser-based, small target systems and other systems requiring extraordinary dynamic stability.

[†] The detail size refers to the line widths for microelectronics fabrication, the particle (cell) size for medical and pharmaceutical research etc. The values given take into account the observation that the vibration requirements of many items depend upon the detail size of the process.

[‡] From ISO 2631 and BS 6472

6 GENERAL ASSESSMENT FOR ESTABLISHING VIBRATION RESPONSE

The guidance presented here provides a method of response analysis that is appropriate for any floor, but assumes the use of finite element analysis to determine the natural frequencies, modal masses and mode shapes of the floor under consideration. These techniques are particularly useful for structures which are complex or have very stringent requirements with regard to vibration.

The use of finite element (FE) methods is described along with suitable design methods which may be used to assess floor response. Finite element modelling is useful to establish a reasonably accurate prediction of the nature of the floor or the whole-building structure and, in all but the simplest of structures, will give a better prediction than that given by hand calculation methods.

Simplified methods are usually only applicable to regular structures which, by and large, have to be created from rectilinear grids. For irregular structures (e.g. buildings with a curved floor on plan), a more complex analysis must be carried out to understand the dynamic properties and to determine the vibration response of the floor. Simplified design methods based on finite element analysis of regular grids are presented in Sections 7 (for composite floors) and 8 (for light gauge steel) as an alternative to the general assessment. Section 6.7 presents a flowchart that provides guidance on the design process and circumstances when each assessment may be appropriate.

6.1 Finite element modelling (FE)

The dynamic performance can be established through finite element modelling of the floor or the whole structure, or similar numerical modelling techniques. FE is an approximation: it takes a continuous structure and breaks each part of the structure into a number of parts, or a finite number of elements. The relationships between these elements are then determined using methods for multi-degree-of-freedom discrete systems. The accuracy of the solution is always dependant on the number of elements that the system is broken into, but with increased accuracy comes increased complexity and hence higher computation times.

6.1.1 Implementation suggestions

From comparisons with measurements made on a wide variety of composite floor types, it is recommended that the following parameters and modelling details should be adopted. Any improvements over these recommendations will obviously lead to a greater accuracy:

- The dynamic modulus of elasticity of concrete should be taken from Section 4.1.3.
- Shell elements should be provided to represent the slab, which should be taken as an effective depth of concrete when profiled steel sheeting is employed and can generally be considered to be continuous. For more information on modelling slabs see Section 6.1.2.

- All connections should be assumed to be rigid (although joints are designed at ULS to be pinned, in vibration the strains are not large enough to overcome the friction and so pinned joints may be treated as fixed).
- Column sections should be provided and pinned at their theoretical inflexion points (typically located at mid-height between floors for multi-storey construction).
- Continuous cladding provided around façades may be assumed to provide full vertical restraint to perimeter beams. The edges of clad buildings should therefore be modelled as free in rotation but restrained in direction for all three directions of freedom (i.e. pinned).
- Core walls may also be assumed to give vertical restraint. However, at cores the connection of the floor is normally stiff enough to be taken as rigid. The interfaces at cores should therefore be modelled as fully restrained.
- The mass of the floor should be equivalent to the self-weight and other permanent loads, plus a proportion of the imposed loads which might be reasonably expected to be permanent, as described in Section 4.1.2.
- Movement joints may be considered to be rotationally free, though fixed in location. For greater accuracy, the exact transfer of stiffness through the joint may be allowed for by consideration of the deflected form. However, as such transfer is small, it is often inefficient to allow for such detail.

One of the most difficult properties to estimate is the level of damping that is present on the floor, due to the fact that it is strongly influenced by finishes and non-structural components. Unless better information is available, it is recommended that the values for damping given in Section 4.1.1 should be adopted.

There are no hard and fast rules for the size of the elements (or mesh) but, in general, if the number of elements can be doubled without significantly changing the frequencies then there are sufficient elements.

6.1.2 Composite construction using profiled steel decking

Where the option is available, it is preferable to use orthotropic shell elements for composite slabs using profiled steel decking. The depth of the slab is set to the depth above the profile and the mass and elastic moduli (of the two directions) are given values that allow for the extra weight and stiffness of the ribs. Ideally this should be used in conjunction with an offset beam element to give the composite stiffness, but if no offsetting is available then the composite stiffness should be calculated and the beam stiffness set as the composite stiffness minus the stiffness of the concrete. This latter case may result in less accurate modal property predictions, particularly if torsional modes of vibration exist.

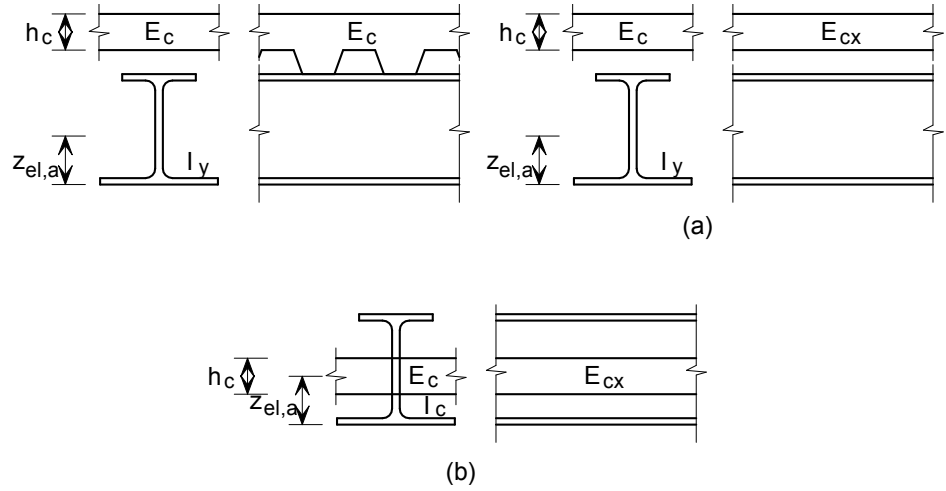

Figure 6.1 *Modelling profiled slabs*

Figure 6.1 shows two possible modelling options (a) and (b). Model (a) uses orthotropic shell elements of a depth h_c with elastic modulus E_c along the beam span and E_{cx} perpendicular to the beam span, with:

$$E_{cx} = E_c \frac{12 I_{c,x}}{h_c^3} \quad (25)$$

where:

- $I_{c,x}$ is the second moment of area of the profiled slab per metre width in the spanning direction
- h_c is the depth of concrete above the profile
- E_c is the dynamic elastic modulus of concrete (see Section 4.1.3).

Model (a) also uses a beam element with the same properties and the same offset as the design. As the slab is modelled using uniform thickness of h_c , the offset, h_s , is:

$$h_s = h + h_a - z_{el,a} - \frac{h_c}{2} \quad (26)$$

where:

- h is the depth of the slab (including the ribs)
- h_a is the depth of the steel beam
- $z_{el,a}$ is the height of the neutral axis of the steel beam.

Note that the density of the concrete will need to be increased to account for the weight of the concrete in the ribs.

Model (b), which will be less accurate than model (a), uses the same slab properties as model (a), if available, but the beam has no offset. Instead, the second moment of area of the beam is calculated according to the following equation:

$$I_c = I_y + A_a \left(h + h_a - z_{el,a} - \frac{h_c}{2} - z_{el,c} \right)^2 + \frac{b_{eff} h_c}{\alpha} \left(z_{el,c} - \frac{h_c}{2} \right)^2 \quad (27)$$

where:

- I_y is the second moment of area of the steel beam
- $z_{el,c}$ is the elastic neutral axis of the composite section
- A_a is the area of the steel beam
- α is the modular ratio (using the dynamic stiffness of concrete)
- b_{eff} is the effective breadth of the concrete (= span/4 or the beam spacing, whichever is smaller).

If an orthotropic slab is not available, the slab should be defined as an isotropic slab with elastic modulus E_{cx} , as defined in Equation (25), and allowance made in Equation (27) for the resulting increased composite stiffness. Again, the density will need to be altered to make allowance for the volume of the concrete within the ribs.

6.2 Modal mass

The required outputs from the finite element analysis are the modal frequencies, the mode shapes and the modal masses. The mode shape can generally be output in two forms – mass normalised and unity normalised.

In mass normalised mode shapes, the output displacements are determined such that the modal mass, M_n , is 1 kg. This combination of mode shape and modal mass can be used in the following equations, but it does not give any indication about the effect of each mode on the overall response.

In unity normalised mode shapes, the maximum displacement is set as a non-dimensional 1 for every mode, as used previously in this publication. To calculate the modal mass corresponding to a unity normalised mode shape, the designer will need to determine the maximum kinetic energy in each mode shape (which can generally be determined by the FE software). The relationship between this and the modal mass is:

$$M_n = \frac{KE_n}{2\pi^2 f_n^2} \quad (28)$$

where:

- M_n is the modal mass for mode n (kg)
- KE_n is the maximum kinetic energy in mode n that corresponds to the unity normalised mode shape (kg/s², or J/m²)
- f_n is the frequency of mode n (Hz).

Note that some finite element packages have an output of mass participation or effective mass, which is generally not the modal mass. To check that the calculation for the modal mass is correct, it is suggested that a model of a simply supported beam is considered, for which all the modal masses are theoretically half of the total mass (from Equation (10), integrated for a sinusoidal mode shape). Note that at higher frequencies the modelling assumptions will mean that this value is not achieved.

6.3 Response analysis

To find the peak response, the following analyses will need to be performed for a range of floor frequencies within the range of walking frequencies (see Section 3.1.1), and the maximum response taken. It should be noted that these methods assume that the force is applied at the most responsive location on the floor even though the walking path will only pass across this point briefly. However, this is a conservative assumption and an analysis based on walking paths, rather than individual points may be taken; this leads to an increased level of complexity. For low frequency floors (where the fundamental frequency is lower than the values given in Table 6.1), both the steady-state response (given in Section 6.3.2) and the transient response (given in Section 6.3.3) need to be checked, as the higher frequencies of the floor may result in the transient response being greater than the steady-state. For high frequency floors only the transient response needs to be checked.

Table 6.1 *Low frequency floor to high frequency floor cut-off*

Floor type	Low to high frequency cut-off
General floors, open plan offices etc.	10Hz
Enclosed spaces, e.g. operating theatre, residential	8Hz
Staircases	12Hz
Floors subject to rhythmic activities	24Hz

6.3.2 Steady-state response of floors

The steady-state response of low frequency floors is significant when one or more of the harmonic components of the walking activity are close to one of the natural frequencies of the floor. In these circumstances, it is recommended that all modes of vibration having natural frequencies up to 2 Hz higher than the cut-off frequency given in Table 6.1 should be considered, to account for off-resonant vibration of the highest harmonic of the activity. The weighted rms acceleration response at a position r , from excitation at a point e , in a single mode of vibration n of frequency f_n , to a forcing sinusoid of frequency hf_p and amplitude F_h may be obtained from the following:

$$a_{w,rms,e,r,n,h} = \mu_{e,n} \mu_{r,n} \frac{F_h}{M_n \sqrt{2}} D_{n,h} W_h \quad (29)$$

where:

- $\mu_{e,n}$ is the mode shape amplitude, from the unity or mass normalised FE output, at the point on the floor where the excitation force F_h is applied
- $\mu_{r,n}$ is the mode shape amplitude, from the unity or mass normalised FE output, at the point where the response is to be calculated
- F_h is the excitation force for the h^{th} harmonic (see Table 3.1 for the Fourier coefficients for walking, Table 3.2 for stairs or Table 3.3 for rhythmic activities), where $F_h = \alpha_h Q$. (N)]
- M_n is the modal mass of mode n (equal to 1kg if the mode shapes are mass normalised) (kg)

$D_{n,h}$ is the dynamic magnification factor for acceleration (see Equation (30))

W_h is the appropriate code-defined weighting factor for human perception of vibrations (see Section 5.2.2), which depends on the direction of the vibrations on the human body using the basicentric coordinate system shown in Figure 5.1 and the frequency of the harmonic under consideration hf_p .

The dynamic magnification factor for acceleration, which is the ratio of the peak amplitude to the static amplitude, is given by the following:

$$D_{n,h} = \frac{h^2 \beta_n^2}{\sqrt{(1 - h^2 \beta_n^2)^2 + (2h\zeta\beta_n)^2}} \quad (30)$$

where:

h is the number of the h^{th} harmonic

β_n is the frequency ratio (taken as f_p/f_n)

ζ is the damping ratio

f_p is the frequency corresponding to the first harmonic of the activity

f_n is the frequency of the mode under consideration.

The total response to each harmonic of the activity is found by summing the acceleration response of each mode of vibration of the system at each harmonic of the forcing function, as shown in Equation (31). The various methods of performing this summation are discussed in Section 6.4.

$$\begin{aligned} a_{w,e,r}(t) &= \sum_{n=1}^N \sum_{h=1}^H a_{w,e,r,n,h}(t) \\ &= \sum_{n=1}^N \sum_{h=1}^H \mu_{e,n} \mu_{r,n} \frac{F_h}{M_n} D_{n,h} \sin(2\pi h f_p t + \phi_h + \phi_{n,h}) W_h \end{aligned} \quad (31)$$

where:

ϕ_h is the phase of the h^{th} harmonic, as specified in Section 3

$\phi_{n,h}$ is the phase of the response of the n^{th} mode relative to the h^{th} harmonic, where:

$$\tan \phi_{n,h} = \frac{-2h\beta_n\zeta}{1 - (h\beta_n)^2} \quad -\pi \leq \phi_{n,h} \leq 0 \quad (32)$$

6.3.3 Transient response of floors

For transient analysis, the response is dominated by a train of impulses, which correspond to the heel impacts made by the walker. In these circumstances, it is recommended that all modes with natural frequencies up to twice the fundamental (first mode) frequency should be taken into account, as above this the effects of the frequency weighting will make the results insignificant. The weighted peak acceleration response at a position r , from excitation at a point e , in a single mode of vibration n of frequency f_n may be obtained from the following:

$$a_{w,\text{peak},e,r,n} = 2\pi f_n \sqrt{1-\zeta^2} \mu_{e,n} \mu_{r,n} \frac{F_1}{M_n} W_n \quad (33)$$

where:

- $\mu_{e,n}$ is the mode shape amplitude, from the unity or mass normalised FE output, at the point on the floor where the impulse force F_1 is applied
- $\mu_{r,n}$ is the mode shape amplitude, from the unity or mass normalised FE output, at the point where the response is to be calculated
- F_1 is the excitation force (as given by Equation (18), see Section 3.1.1) (Ns)
- M_n is the modal mass of mode n (equal to 1 if the mode shapes are mass normalised) (kg)
- W_n is the appropriate code-defined weighting factor for human perception of vibrations (see Section 5.2.2), which depends on the direction of the vibrations on the human body using the basicentric coordinate system shown in Figure 5.1 and the frequency of the mode under consideration f_n .

The acceleration to each impulse is found by summing the acceleration responses of each mode using the following superposition formula. The method shown in Equation (12) can then be used to determine the rms acceleration, taking T as $1/f_p$.

$$\begin{aligned} a_{w,e,r}(t) &= \sum_{n=1}^N a_{w,e,r,n}(t) \\ &= \sum_{n=1}^N 2\pi f_n \sqrt{1-\zeta^2} \mu_{e,n} \mu_{r,n} \frac{F_1}{M_n} \sin\left(2\pi f_n \sqrt{1-\zeta^2} t\right) \cdot e^{-\zeta 2\pi f_n t} W_n \end{aligned} \quad (34)$$

6.3.4 Excitation and response positions

The excitation point, e , and the response point, r , should be chosen to produce the maximum response of the floor. In most cases e and r will represent the same point (as the maximum response to any excitation is coincident with the excitation point), and so should be checked for every point defined in the finite element analysis. In practice, however, only the points that correspond to the maximum amplitudes for each mode need to be checked.

In the case of a response in a room from excitation in a corridor, e and r should be chosen to be the maximum amplitude of displacement in the respective areas for each mode. In all cases, the mode shape amplitudes can be taken conservatively as 1 when using the modal mass corresponding to unity normalised mode shapes. Examples of selecting the mode shape factors are given in Figure 6.2 and Table 6.2, where the case corresponds to the modes for which the maximum amplitudes are chosen.

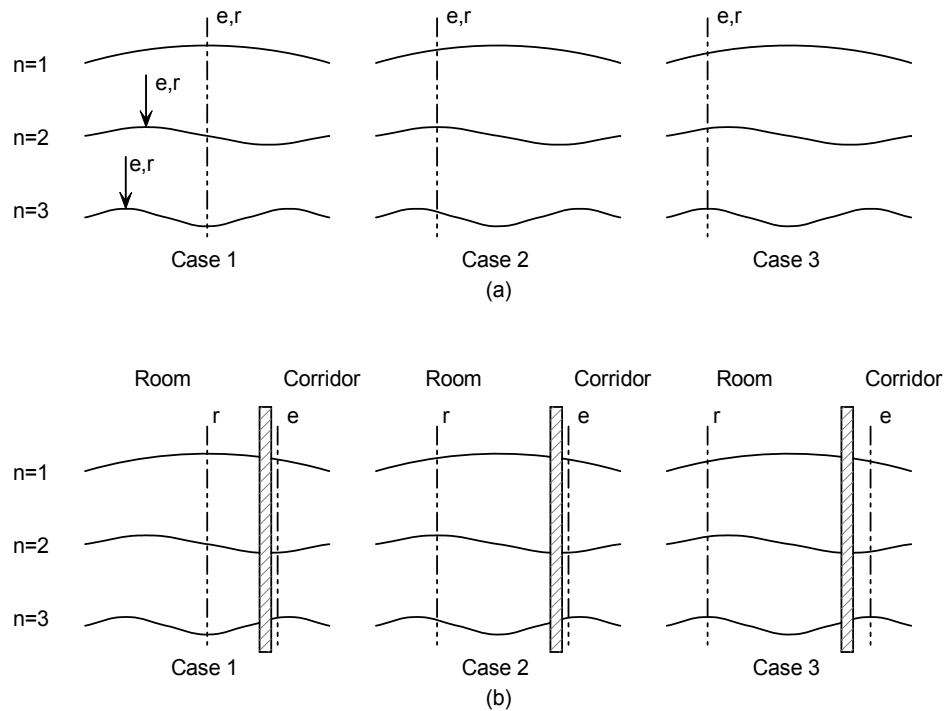

Figure 6.2 Mode shape factors for (a) maximum response and (b) response in a room to excitation in a corridor

Table 6.2 Mode shape factors for corridor to room response as shown in Figure 6.2(b)

Case	Amplitudes of Mode 1		Amplitudes of Mode 2		Amplitudes of Mode 3	
	$\mu_{e,1}$	$\mu_{r,1}$	$\mu_{e,2}$	$\mu_{r,2}$	$\mu_{e,3}$	$\mu_{r,3}$
1	0.59	1.00	-0.95	0.00	0.95	-1.00
2	0.59	0.71	-0.95	1.00	0.95	0.71
3	0.50	0.50	-0.87	0.87	1.00	1.00

6.4 Summing accelerations

When the steady-state accelerations have been established for each mode in response to each harmonic it is necessary to sum all the results to obtain the overall acceleration and calculate the response factor. There are three main methods for performing this summation: full time-history; sum of peaks; and square-root of the sum of the squares (SRSS).

6.4.1 Full time history

This is the most accurate of the methods and will yield both peak and rms accelerations, and is simply the evaluation of Equation (31); however, this calculation is computationally intensive, and if only the rms acceleration is required other methods are simpler without any significant loss of accuracy. A typical result is shown in Figure 6.3 (denoted as ‘actual’).

6.4.2 Sum of peaks (SoP)

This method is always conservative, as it assumes that all of the components of the response will peak at the same time and will continue to peak at the same time, which is clearly false in the case of several active mode shapes acting at different frequencies; as such, the rms acceleration predicted will always be much more conservative than the peak acceleration. The procedure is shown in Equation (35) and a typical result is shown graphically in Figure 6.3.

$$a_{w,rms,e,r} = \frac{1}{\sqrt{2}} \sum_{h=1}^H \sum_{n=1}^N \mu_{e,n} \mu_{i,n} \frac{F_h}{M_n} D_{n,h} W_h \quad (35)$$

6.4.3 Square-root sum of squares (SRSS)

SRSS is a method used to determine the rms acceleration of a response, and will give the same result as a full time history. The procedure is shown in Equation (36), and a typical result is shown in Figure 6.3.

$$a_{w,rms,e,r} = \frac{1}{\sqrt{2}} \sqrt{\sum_{h=1}^H \left(\sum_{n=1}^N \left(\mu_{e,n} \mu_{r,n} \frac{F_h}{M_n} D_{n,h} W_h \right) \right)^2} \quad (36)$$

Of the three procedures described, SRSS gives the best compromise between complexity and accuracy.

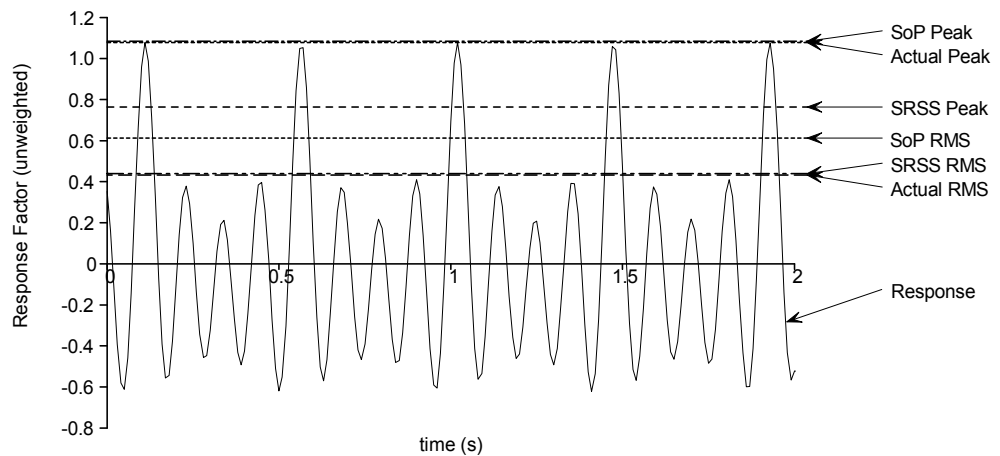

Figure 6.3 Estimations of peak and rms accelerations

6.5 Acceptability criteria for continuous vibrations

6.5.1 Frequency weighting

Equations (29) and (33) require the use of a weighting factor, W , which is defined in Section 5.2.2. Since the weighting factors are all ≤ 1.0 , a factor of 1.0 may conservatively be applied for preliminary design, though this will reduce the benefits of the frequency weighting.

6.5.2 Resonance build-up factor

If a walking path is sufficiently short a steady-state condition may not be reached. When the layout of partitions and the length of corridors is known,

this build up of the response may be taken into account. The following resonance build-up factor can be applied to the steady-state rms acceleration calculated above:

$$\rho = 1 - e^{\left(\frac{-2\pi\zeta L_p f_p}{v}\right)} \quad (37)$$

where:

- f_p is the pave frequency
- ζ is the critical damping ratio (see Table 4.1)
- L_p is the length of the walking path
- v is the velocity of walking, from Equation (16).

Equation (37) is presented in Figure 6.4 for the three common values of the critical damping ratio, using a typical stride length of 0.75 m (corresponding to a pace frequency of 2.0 Hz).

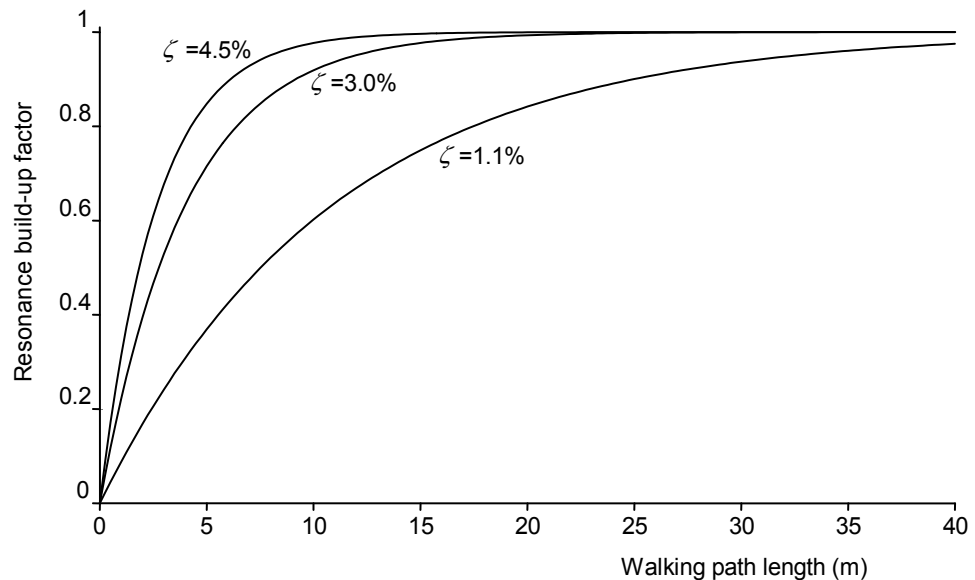

Figure 6.4 Resonance build-up factor for walking path length

6.5.3 Response factor evaluation

The ‘response factor’ of a floor is the ratio between the calculated weighted rms acceleration, from either the steady-state (with, if necessary, the resonance build-up factor) or transient methods, and the ‘base value’ given in BS 6472^[3] (see Section 5.3.1). The vibration response is considered to be satisfactory for continuous vibrations when the calculated response does not exceed a limiting value appropriate to the environment (which is expressed in BS 6472 and ISO 10137 as a multiplying factor); the limiting values are those given in Table 5.2 or Table 5.3.

z-axis vibration

For z-axis vibrations, the response factor, R , is given by:

$$R = \frac{a_{w,rms}}{0.005} \quad (38)$$

x- and y-axis vibration

For x- and y-axis vibrations, the response factor, R , is given by:

$$R = \frac{a_{w,rms}}{0.00357} \quad (39)$$

6.6 Vibration dose values (VDVs)

If calculated response values are within the limits of the multiplying factors for continuous vibrations, there is no need to consider the intermittent nature of the dynamic forces. However, for the situation where the floor has a higher response than would be acceptable under the conservative limits for continuous vibration, and the design specification permits the use of VDVs, the acceptability may be assessed by considering the intermittent nature of the dynamic forces. A VDV analysis is effectively allowing the response to be greater than those specified for continuous vibrations, but only for small periods of time.

As explained in Section 5.2.3, representative values of VDVs are given by Equation (24) and the limits, specified in BS 6472, are given in Table 5.4. From Ellis^[36], the VDV of a walking activity of duration T_a that occurs n_a times in an exposure period is:

$$VDV = 0.68 a_{w,rms} \sqrt[4]{n_a T_a} \quad (40)$$

where:

T_a is the duration of an activity (for example, the time taken to walk along a corridor) (s)

n_a is the number of times the activity will take place in an exposure period.

a_{rms} is the frequency-weighted rms acceleration (m/s²).

This value can be directly compared to the limits given in Table 5.4. Alternatively this equation can be rearranged to give the number of times an activity can occur in an exposure period and still correspond to 'a low probability of adverse comment'.

$$n_a = \frac{1}{T_a} \left[\frac{VDV}{0.68 \times a_{w,rms}} \right]^4 \quad (41)$$

where:

VDV is the value from Table 5.4 that corresponds to the environment under consideration (m/s^{1.75}).

According to BS 6472^[3], the exposure periods that should be considered are a 16h day and an 8h night, and a VDV analysis can be considered to be satisfactory if the floor will be traversed fewer than n_a times in the exposure period.

6.7 Design process chart

The flowchart shown in Figure 6.5 may be used as a guide to the design process using both the general and simplified methods.

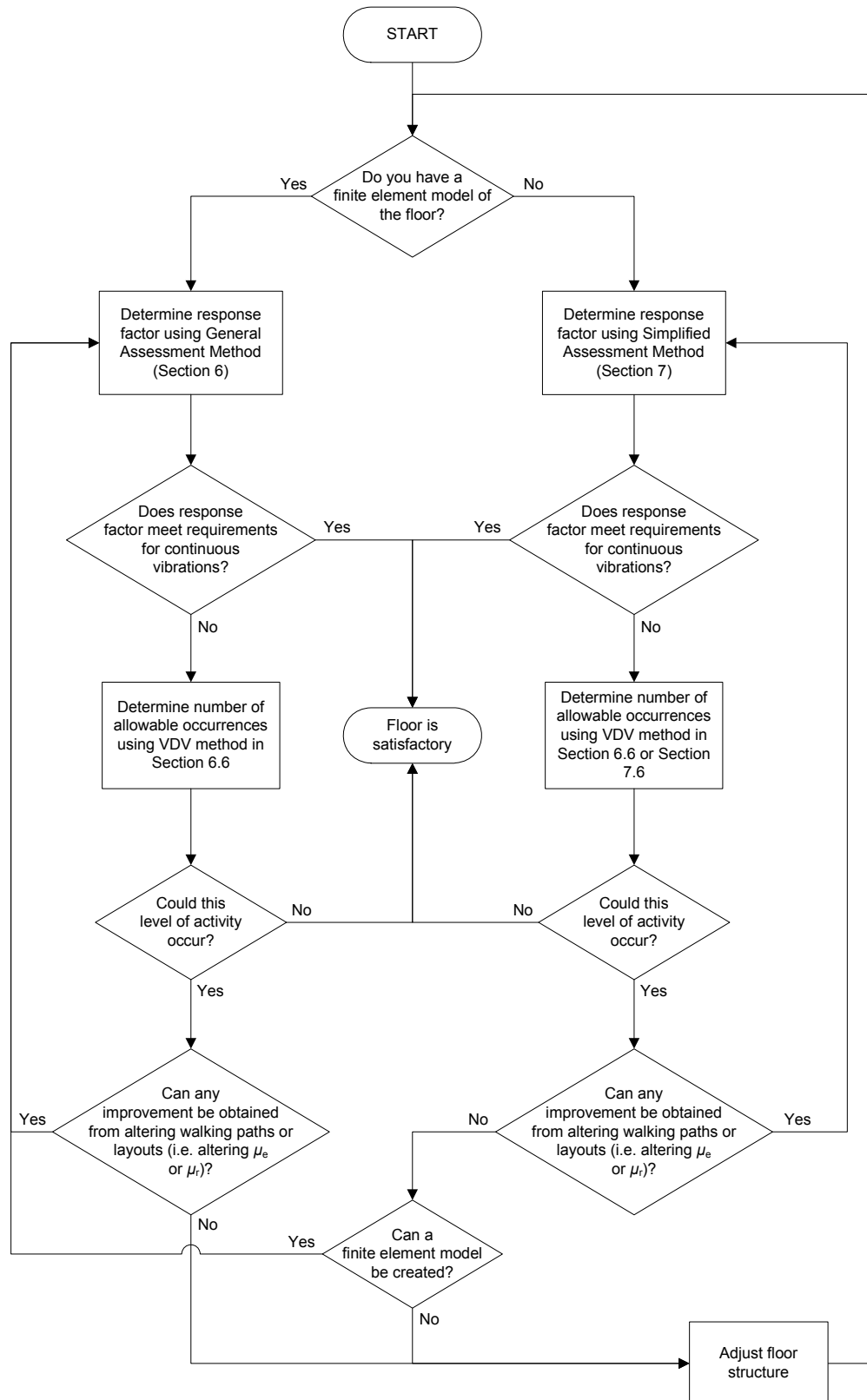

Figure 6.5 Design process chart for floor assessment

7 SIMPLIFIED ASSESSMENT FOR STEEL FLOORS

The following design procedure is based on a parametric study of a wide variety of regular floor grids modelled using the approach given in Section 6, and is suitable for composite floors. A flowchart is presented in Section 6.7 that provides guidance on the design process. Comparison of the method with the response from finite element analysis, and with test results, is presented in Appendix A.

The design procedures for assessing the dynamic performance of floors comprise:

- Definition of natural frequency.
- Definition of modal mass for the floor.
- Evaluation of response.
- Checking of response against acceptance criteria.

Detailed guidance on the procedures for composite floors is given below.

7.1 Fundamental frequency

In conventional steel-concrete floor systems, the fundamental frequency may be estimated by using engineering judgement on the likely deflected shape of the floor (the mode shape), and considering how the supports and boundary conditions will affect the behaviour of the individual structural components. For example, on a simple composite floor comprising a slab continuous over a number of secondary beams that are, in turn, supported by stiff primary beams, two possible mode shapes may be sensibly considered:

Secondary beam mode

The primary beams form nodal lines (i.e. they have zero deflection), about which the secondary beams vibrate as simply-supported members (see Figure 7.1(a)). The slab is assumed to be continuous over the secondary beams and so a fixed-ended boundary condition is used.

Primary beam mode

The primary beams vibrate about the columns as simply-supported members (see Figure 7.1(b)), and the secondary beams and slab are taken to be fixed-ended.

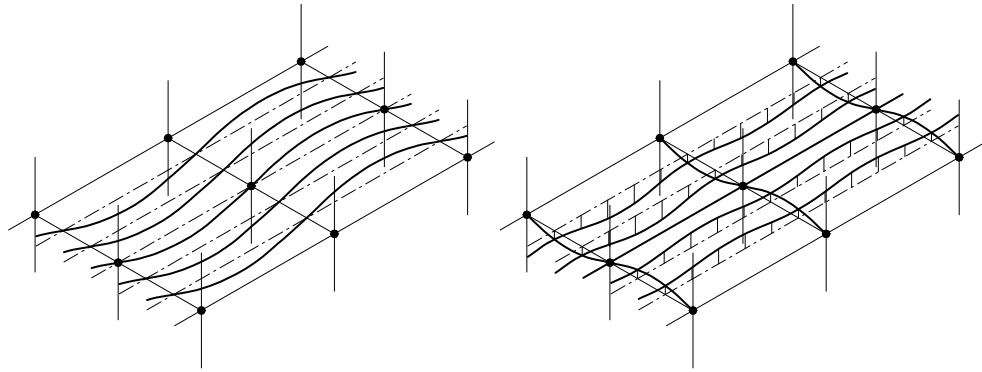

(a) governed by secondary beam flexibility (b) governed by primary beam flexibility

Figure 7.1 Typical mode shapes for steel-concrete floor systems

The natural frequency should be calculated for each mode, in accordance with the guidance given in Section 2.2.1, using Equation (4). The fundamental frequency, f_0 , is the lower value for the two modes considered.

$$f_0 = \frac{18}{\sqrt{\delta}} \quad (4)$$

Where δ is the total deflection (in millimetres) of the slab, secondary beams and primary beams using the end conditions described above and based on the gross second moment of area of the components, with a load corresponding to the self weight, and other permanent loads, plus a proportion of the imposed load that may be considered permanent (taken to be a maximum of 10% of the unfactored imposed load - see Section 4.1.2).

For cases when the adjacent spans are approximately equal, δ can be calculated from the equations given in Table 7.1.

Table 7.1 Calculation of deflection for different framing arrangements

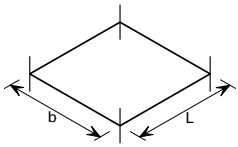
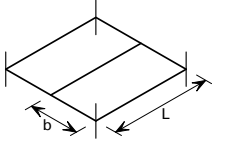
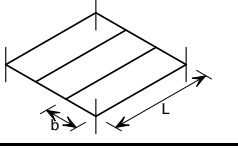
Framing arrangement	Secondary beam mode of vibration	Primary beam mode of vibration
	$\delta = \frac{mgb}{384 E} \left(\frac{5L^4}{I_b} + \frac{b^3}{I_s} \right)$	-
	As above	$\delta = \frac{mgb}{384 E} \left(\frac{64b^3 L}{I_p} + \frac{L^4}{I_b} + \frac{b^3}{I_s} \right)$
	As above	$\delta = \frac{mgb}{384 E} \left(\frac{368b^3 L}{I_p} + \frac{L^4}{I_b} + \frac{b^3}{I_s} \right)$

where:

- m is the distributed floor loading as described above (kg/m²)
- g is the acceleration due to gravity (=9.81m/s²)

- E is the elastic modulus of steel (N/m²)
- I_b is the composite second moment of area of the secondary beam, using $b_{\text{eff}} = L/4$ or b , whichever is smaller (m⁴)
- I_s is the second moment of area of the slab per unit width in steel units using the dynamic value of the elastic modulus (see Section 4.1.3) (m⁴/m)
- I_p is the composite second moment of area of the primary beam, using $b_{\text{eff}} = L/4$ or the primary beam spacing, whichever is smaller (m⁴).

As an alternative to calculating the second moment of area of a composite slab directly, the approximate values given in Table 7.2 may be used, where h_s is the overall depth of the slab (in mm).

Table 7.2 *Approximate dynamic second moment of area for composite slabs with different deck types in steel units*

Profile type	Deck height, h_p	Dynamic second moment of area per metre width, I_s (mm ⁴ /m)	
		NWC	LWC
Re-entrant deck	$h_p = 51$ mm	$0.37 h_s^{3.7}$	$0.65 h_s^{3.5}$
Trapezoidal deck	$h_p = 60$ mm	$0.23 h_s^{3.7}$	$0.40 h_s^{3.5}$
Trapezoidal deck	$h_p = 80$ mm	$0.19 h_s^{3.7}$	$0.37 h_s^{3.5}$
Trapezoidal deck	$h_p = 225$ mm	$0.05 h_s^{3.7}$	$0.12 h_s^{3.5}$

h_s is the overall depth of the slab in mm.

For cases where composite beams have dissimilar spans, and are continuous over supports (or beams whose second moment of area is significantly different in each span), the designer may wish to account for the beneficial stiffening effect provided by the short span(s) increasing the natural frequency of the structural element. In these circumstances, the natural frequency may be estimated from Equation (4), but replacing the beam component of δ by $\bar{\delta}$. For two continuous spans:

$$\bar{\delta} = \left(\frac{0.4 + \frac{I_M L_S}{I_S L_M} \left(1 + 0.6 \frac{L_S^2}{L_M^2} \right)}{1 + \frac{I_M L_S}{I_S L_M}} \right) \delta_M \quad (42)$$

where:

- δ_M is the simply-supported deflection due to the self-weight and other permanent loads on the main (larger) span, L_M
- I_M is the second moment of area of the larger span
- I_S is the second moment of area of the smaller span, L_S .

For three continuous spans:

$$\bar{\delta} = \left(\frac{0.6 + 2 \frac{I_M L_S}{I_S L_M} \left(1 + 1.2 \frac{L_S^2}{L_M^2} \right)}{3 + 2 \frac{I_M L_S}{I_S L_M}} \right) \delta_M \quad (43)$$

where:

L_M, I_M refer to the middle span

L_S, I_S refer to the smaller of the outer spans.

7.2 Minimum floor frequency

To ensure that the walking activities will be outside the range which could cause resonant or close-to-resonant excitation of the fundamental mode of vibration of the floor, no floor structure should have a fundamental frequency less than 3 Hz. Similarly, no single element within the floor structure should have a fundamental frequency less than 3 Hz.

7.3 Modal Mass

The modal mass, M , is calculated from an effective plan area of the floor participating in the motion as follows:

$$M = mL_{\text{eff}} S \quad (44)$$

where:

m is the floor mass per unit area including dead load and imposed load that will be present in service (see Section 4.1.2)

L_{eff} is the effective floor length (see Equation (45) or (47))

S is the effective floor width (see Equation (46) or (48)).

Note that the stiffnesses used in the following equations do not depend on the dominant mode shape of the two considered for frequency calculations above.

7.3.1 Modal mass for floors using downstand beams with shallow decking

For floors constructed with shallow decking and downstand beams (i.e. the decking is supported on the top flange of the beam), the variables L_{eff} and S should be calculated from the following equations:

$$L_{\text{eff}} = 1.09(1.10)^{n_y - 1} \left(\frac{EI_b}{mbf_0^2} \right)^{1/4} \quad L_{\text{eff}} \leq n_y L_y \quad (45)$$

where:

n_y is the number of bays (where $n_y \leq 4$) in the direction of the secondary beam span (see Figure 7.2)

EI_b is the dynamic flexural rigidity of the composite secondary floor beam (expressed in Nm^2 when m is expressed in kg/m^2)

- b is the floor beam spacing (expressed in m)
- f_0 is the fundamental frequency (as defined in Section 7.1)
- L_y is the span of the secondary beams (expressed in m; see Figure 7.2).

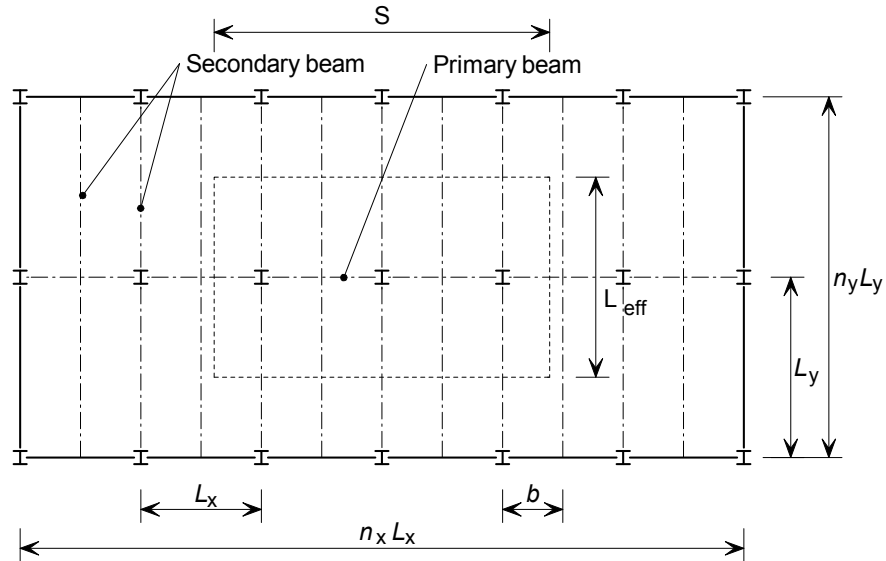

Figure 7.2 Definition of variables used to establish effective modal mass

The effective floor width S should be calculated from the following equation:

$$S = \eta (1.15)^{n_x - 1} \left(\frac{EI_s}{mf_0^2} \right)^{1/4} \quad S \leq n_x L_x \quad (46)$$

where:

- L_x is the span of primary beam (expressed in m; as shown in Figure 7.2)
- n_x is the number of bays (where $n_x \leq 4$) in the direction of the primary beam span (see Figure 7.2).
- η is a factor that accounts for the influence of floor frequency on the response of the slab (see Table 7.3)
- EI_s is the dynamic flexural rigidity of the slab (expressed in Nm^2/m when m is expressed in kg/m^2)
- f_0 is the fundamental frequency (as defined in Section 7.1)
- L_x is the width of a bay (see Figure 7.2).

Table 7.3 Frequency factor η

Fundamental frequency, f_0	η
$f_0 < 5$ Hz	0.5
$5 \text{ Hz} \leq f_0 \leq 6$ Hz	$0.21 f_0 - 0.55$
$f_0 > 6$ Hz	0.71

7.3.2 Modal mass for floors using slim floor beams with deep decking

For floors constructed with deep decking placed on the bottom flange of the support member (i.e. systems such as *Slimdek*), the variables L_{eff} and S should be calculated from the following equations:

$$L_{\text{eff}} = 1.09 \left(\frac{EI_b}{mL_x f_0^2} \right)^{1/4} \quad L_{\text{eff}} \leq n_y L_y \quad (47)$$

where:

EI_b is the dynamic flexural rigidity of the composite secondary floor beam (expressed in Nm^2 when m is expressed in kg/m^2)

L_x is floor beam spacing (expressed in m)

n_y is the number of bays (where $n_y \leq 4$) in the direction of the secondary beam span (see Figure 7.2)

f_0 is the fundamental frequency (as defined in Section 7.1).

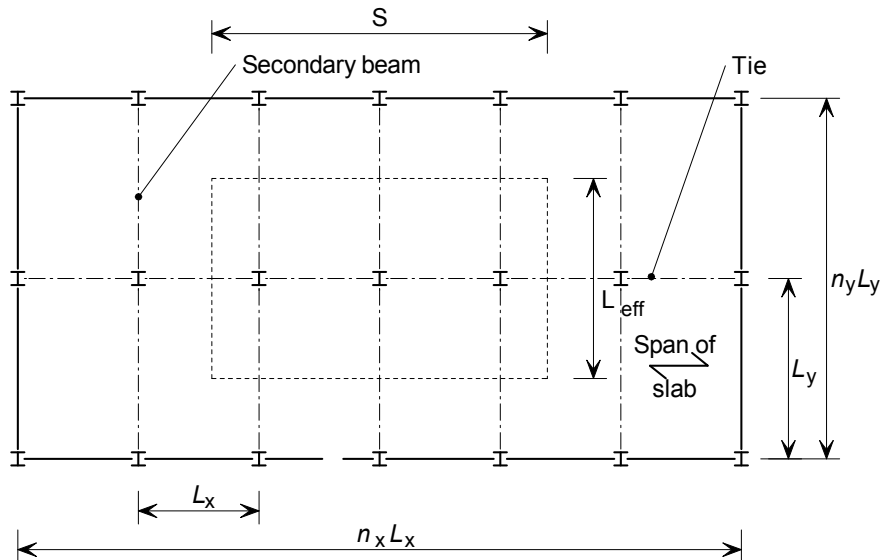

Figure 7.3 Definition of variables used to establish effective modal mass

The effective floor width S should be calculated from the following equation:

$$S = 2.25 \left(\frac{EI_s}{mf_0^2} \right)^{1/4} \quad S \leq n_x L_x \quad (48)$$

where:

EI_s is the dynamic flexural rigidity of the slab in the strong direction (expressed in Nm^2/m when m is expressed in kg/m^2)

f_0 is the fundamental frequency (as defined in Section 7.1)

L_x is the width of a bay (see Figure 7.3)

n_x is the number of bays (where $n_x \leq 4$) in the direction of the primary beam span (see Figure 7.3).

7.4 Mode shape factor

As shown in Figure 7.1, there are two main mode shapes which relate to the lowest frequencies – a secondary beam mode and a primary beam mode. The lowest frequency of the two modes should be used, and the mode shape factors should be determined for the same mode. The mode shape factors (given in Equation (49) and shown graphically in Figure 7.4) assume a sinusoidal shape along the relevant beams and conservatively assumes that this applies for the slab spanning between the beams.

$$\mu_e \text{ or } \mu_r = \sin\left(\pi \frac{z}{L}\right) \quad (49)$$

where:

- μ_e is the mode shape factor at the point of excitation, normalised to the anti-node
- μ_r is the mode shape factor at the point of response, normalised to the anti-node
- z is the distance of the excitation or response point from the nearest beam in the y direction for the secondary beam mode and in the x direction for the primary beam mode (in m).
- L is L_y for the secondary beam mode and L_x for the primary beam mode (m).

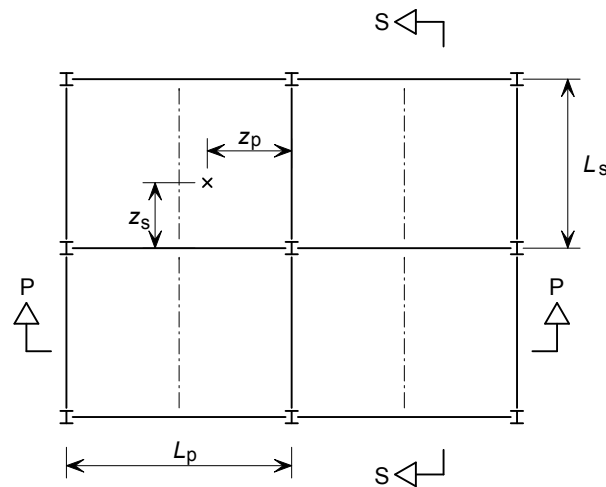

Section P - P Primary beam mode

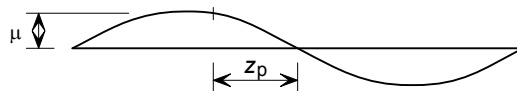

Section S - S Secondary beam mode

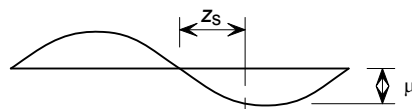

Figure 7.4 Determining mode shape factors

If the response and excitation points are unknown, or if a general response for the whole floor is required, μ_e and μ_r can conservatively be taken as 1.

7.5 Response acceleration

7.5.1 Response acceleration for low frequency floors

For fundamental frequencies between 3 Hz and 10 Hz, the rms acceleration should be calculated assuming a resonant response to one of the harmonics of walking frequency as follows:

$$a_{w,rms} = \mu_e \mu_r \frac{0.1Q}{2\sqrt{2} M\zeta} W\rho \quad (50)$$

where:

- μ_e is the mode shape factor at the point of excitation, normalised to the anti-node, as defined in Section 7.4
- μ_r is the mode shape factor at the point of response, normalised to the anti-node, as defined in Section 7.4
- ζ is the critical damping ratio, as given in Section 4.1.1
- Q is the weight of a person, normally taken as 746 N (76 kg \times 9.81 m/s²)
- M is the modal mass, as defined in Section 7.3 (kg)
- ρ is the resonance build-up factor from Equation (37), see Section 6.5.2
- W is the appropriate code-defined weighting factor for human perception of vibrations (see Section 7.6), based on the fundamental frequency, f_0 .

7.5.2 Response acceleration for high frequency floors

If the fundamental frequency is greater than 10 Hz, the rms acceleration should be calculated from the following expression, which assumes that the floor exhibits a transient response:

$$a_{w,rms} = 2\pi\mu_e\mu_r \frac{185}{Mf_0^{0.3}} \frac{Q}{700} \frac{1}{\sqrt{2}} W \quad (51)$$

where:

- f_0 is the fundamental frequency of the floor (Hz)
- μ_e is the mode shape factor at the point of excitation, normalised to the anti-node, as defined in Section 7.4
- μ_r is the mode shape factor at the point of response, normalised to the anti-node, as defined in Section 7.4
- M is the modal mass, as defined in Section 7.3 (kg)
- Q is the static force exerted by an 'average person' (normally taken as 76 kg \times 9.81 m/s² = 746 N)
- W is the appropriate code-defined weighting factor for human perception of vibrations (see Section 7.6), based on the fundamental frequency, f_0 .

7.6 Acceptance criteria

Frequency Weighting

The frequency weighting factor, W , used in Equations (50) and (51) can be determined from the curves presented in Figure 5.2 and Figure 5.3, using $f=f_0$. As an alternative to the curves presented in Section 5.2.2, the curve shown in Figure 7.5 may be used when the axis of vibration (as defined in Figure 5.1) is unknown.

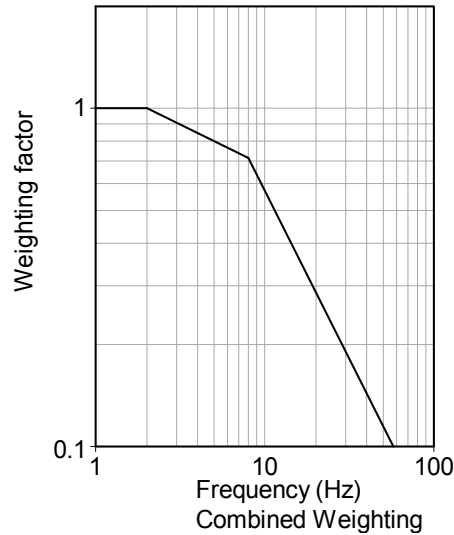

Figure 7.5 *Combined weighting curve*

Response Factor

Once the weighted rms acceleration has been determined, the response factor, R , may be calculated using:

$$R = \frac{a_{w,rms}}{0.005} \quad (38)$$

The value of the response factor should not exceed the value of the appropriate multiplying factor given in Table 5.2 and Table 5.3.

Vibration dose values (VDV)

If the response factor is greater than the appropriate multiplying factor, and analysis using the VDV method is acceptable for the floor, the procedure presented in Section 6.6 may be used.

The following figures show the number of crossings per hour required to give an acceptable VDV (using Equation (40) - see Section 5.3.3) for a given response factor. If the floor traffic will be less than the values shown for a given corridor length then the floor will be acceptable.

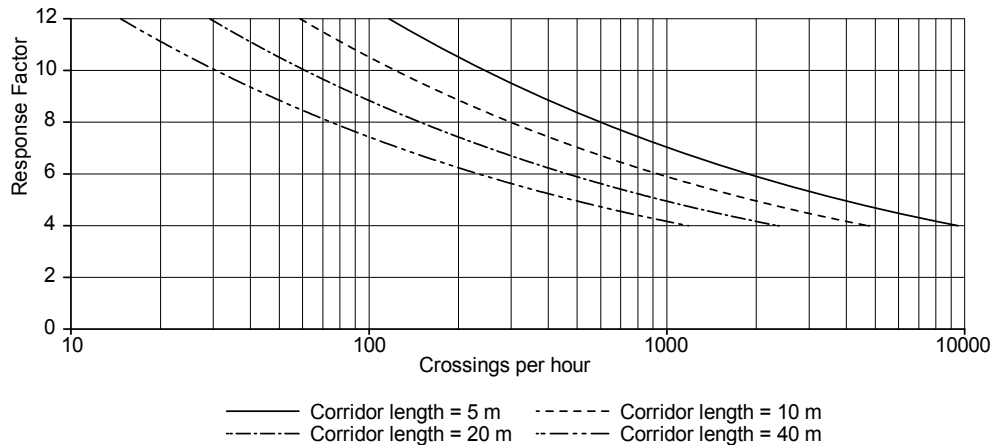

Figure 7.6 *Maximum number of walking crossings per hour for various response factors and corridor lengths for z-axis vibrations in office, residential and general laboratory environments during a 16-hour day (VDV = 0.4 m/s^{1.75})*

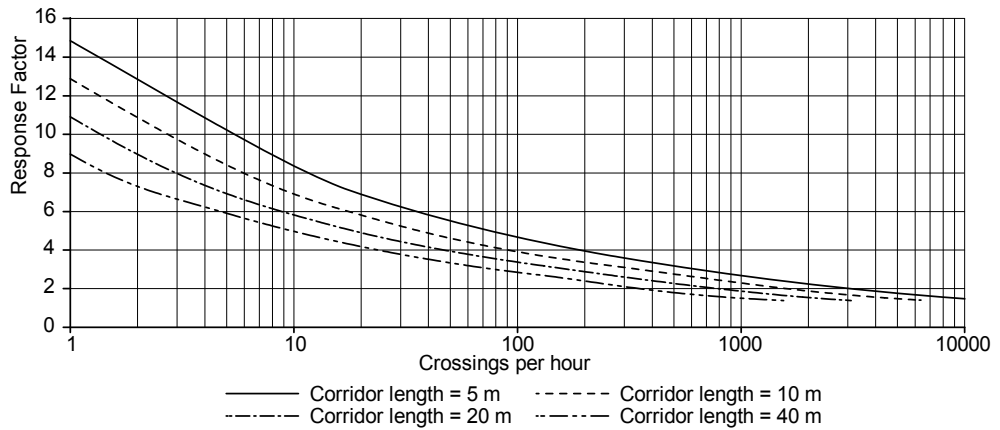

Figure 7.7 *Maximum number of walking crossings per hour for various response factors and corridor lengths for x- and y-axis vibrations in residential and hospital ward environments during an 8-hour night (VDV = 0.09 m/s^{1.75})*

8 SPECIAL CASES

8.1 Floors subject to rhythmic activities

8.1.1 Design requirements

Where floors are likely to be subject to dancing and jumping activities characterised by synchronised crowd movement, the floor must be designed for ultimate limit state considerations in accordance with the requirements given in Annex A of BS 6399-1^[23] or the National Annex to BS EN 1991-1.1. According to these Standards:

- The floor may be designed to have a fundamental frequency of at least 8.4 Hz vertically and a frequency of at least 4 Hz horizontally, in which case the resonant effects need not be evaluated (see Section 3.1.3).

or

- The floor should be designed to resist the anticipated dynamic loads due to rhythmic activity, which should be considered as an additional imposed load case (with $\gamma_f = 1,0$).

The vertical natural frequency of the floor should be evaluated for the appropriate mode of vibration of an empty structure.

If the vertical floor frequency is below 8.4 Hz, the procedure given in Section 8.1.2 can be used to determine dynamic loads. Determination of the horizontal frequency depends on the structure's bracing system and is outside the scope of this document, but numerical modelling of a whole structure should give horizontal modes of vibration as well as vertical.

8.1.2 Dynamic loads

Should the fundamental frequency of the floor exceed 8.4 Hz (i.e. corresponding to the maximum third harmonic frequency $3 \times 2.8 \text{ Hz} = 8.4 \text{ Hz}$), the floor may be considered insensitive to resonant effects at the ultimate limit state (but not necessarily at the serviceability limit state). This is a higher limit than the value of 6 Hz used for stadia^[40] as a higher level of synchronicity can be obtained.

Where the floor cannot be designed to have a minimum fundamental frequency of 8.4 Hz, it should be designed to resist the anticipated dynamic loads, which should be considered as an additional imposed load case. In these circumstances, the force per unit area can be calculated using the following equation, assuming a crowd density appropriate to the floor use (see Section 3.1.3 for guidance).

$$F(t) = q \left\{ 1.0 + \sum_{h=1}^H \alpha_h D_{\delta,h} \sin(2h\pi f_p t + \phi_h + \phi_{1,h}) \right\} \quad (52)$$

where:

q is the weight of the jumpers per unit area (usually taken as 746 N per individual)

$D_{\delta,h}$ is the dynamic amplification factor for displacements for the h^{th} harmonic of the activity frequency, calculated from Equation (53)

H is the total number of Fourier terms to be considered

- α_h is the Fourier coefficient (or dynamic load factor) of the h^{th} term from Table 3.3 or Equation (20), as appropriate
- f_p is the frequency of the jumping load
- ϕ_h is the phase lag of the h^{th} term from Table 3.3 or Equation (20), as appropriate.
- $\phi_{1,h}$ is the phase of the response of the first mode relative to the h^{th} harmonic, from Equation (32)

$$D_{\delta,h} = \frac{1}{\sqrt{(1 - h^2 \beta^2)^2 + (2h\zeta\beta)^2}} \quad (53)$$

where:

- h is the number of the h^{th} harmonic
- β is the frequency ratio (taken as f_p/f_1)
- ζ is the damping ratio
- f_1 is the fundamental frequency of the floor.

To reduce the amount of calculation effort, Equation (52) can be simplified by making the conservative assumption that all of the harmonics peak at the same time:

$$F = q \left(1.0 + \sum_{h=1}^H \alpha_h D_{\delta,h} \right) \quad (54)$$

To determine the maximum force, the activity frequency should be chosen so that one of the harmonics, h , corresponds to the lowest frequency of the floor:

$$f_p = \frac{f_1}{h} \quad (55)$$

where:

- f_p is the activity frequency to be used in Equation (53)
- f_1 is the fundamental frequency of the floor
- h is the lowest integer that will give f_p in the range specified in Section 3.1.3, i.e. 1.5 to 3.5 Hz for individuals, 1.5 to 2.8 Hz for groups.

8.1.3 Floor response

For serviceability considerations, the first six harmonic components given in Table 3.3 should be used to estimate the floor accelerations. If the floor frequency is greater than 24 Hz, then the floor may be considered to be unresponsive for serviceability conditions.

Acceleration due to rhythmic activities is usually only calculated for areas of floors which are occupied and connected to, but are not, the area where the rhythmic activity is taking place. These responses need to be calculated according to the general approach as they cannot accurately be calculated simply by hand. Instead the response at one point on the floor is determined for each of the points where the excitation is taking place (using techniques given in

Section 6 and the Fourier coefficients given in Table 3.3), and these responses summed to give the total response. As suggested in Section 5.3.4, a response factor of 120 may be considered appropriate for the area where the activity is taking place.

8.2 Hospital floors

The design guidance presented here is valid for composite floors using hot rolled steel sections, including new forms of construction such as *Slimdek*[®]. It has been shown^[41] that this form of construction is often suitable for use in hospitals with little or no modification compared to designs used in the commercial sector.

Recent measurements from *in situ* tests on a variety of hospital floors with operating theatre areas have demonstrated^[42] that composite floors are capable of achieving the multiplying factors specified in Health Technical Memorandum 08-01^[29] (HTM 08-01). From these measurements, the following supplementary rules may be used with the approaches given in Sections 6 and 7.

8.2.1 Design Parameters

Vibration assessment for hospitals should generally be carried out for the pace frequency ranges given in Section 3.1.1 for circulation areas and corridors. However, for hospitals, a further category of pace frequency range needs to be considered, to reflect the walking speed which will be likely when the activity takes place near to a patient. In this case, the walker will be likely to be sensitive to the patient and will tend to walk more slowly. In addition to the pace frequencies given in Section 3.1.1, the following should be considered:

Walking activities in a near-patient environment:	1.5 – 1.8 Hz
Operating theatres:	1.8 Hz

8.2.2 Acceptance criteria

Continuous vibrations

Vibration disturbance to patients, staff and equipment needs to be considered in the structural design to ensure that vibration is limited to an acceptable level. As explained in Section 5.3, satisfactory vibration limits in buildings are specified in terms of multiplying factors applied to the appropriate base curve, which are calculated in terms of frequency-weighted accelerations; the weighting factor depends on the orientation of the vibration relative to the body and on the type of activity being undertaken. However, the limiting values in HTM 08-01 are defined for use only with the W_g weighting factor shown in Figure 5.2, which is for standing or seated people when hand control is important, and a base acceleration value of 5 mm/s² (as used in Equation (38)). Consequently, the values take different values from those in BS 6472 (reproduced in Table 5.2). The criteria in HTM 08-01^[29] Section 2.132 (and reproduced in Table 8.1, below) give values of multiplying factors that will result in a low probability of adverse comment for continuous activities in hospitals.

Table 8.1 *Multiplying factors given in HTM 08-01 for a ‘low probability of adverse comment’*

Room Type	Multiplying factor for continuous vibration
Operating theatres, precision laboratories, audiometric testing booth	1
Wards	2
General laboratories, treatment areas	4
Offices, consulting rooms	8

Intermittent vibrations

As explained in Section 5.3.3, where vibrations are intermittent (i.e. walking activities), BS 6472 allows a vibration dose value (VDV) assessment to be carried out to calculate the summation of the vibration over a set exposure period. The VDV should be calculated in accordance with the guidance in Section 6.6. For hospitals, the maximum allowable values for VDV_s are given in HTM 08-01 Section 2.133, and are reproduced in Table 8.2. Again, the W_g weighting factor should be used in all cases, independent of the actual orientation or activity type.

Table 8.2 *HTM 08-01 limiting VDV values for hospital floors*

Room Type	Maximum VDV value (m/s ^{1.75})
Wards, residential – day	0.2
General laboratories, offices	0.4
Workshops	0.8

For operating theatres and critical working environments such as precision laboratories, the VDV assessment method may not be used because a single event in excess of perceptibility could cause a critical consequence to occur.

Sensitive equipment

Although the vibration criteria given in Table 8.1 and Table 8.2 are appropriate for equipment commonly used in wards and treatment rooms (according to the guidance in HTM 08-01), some medical equipment is very sensitive to vibration and will either need to be isolated from the floor plate (located on very stiff structures away from sources of vibration) or will need to be accounted for in the design of the floor response to vibration. Specific guidance should be sought from the manufacturers to ensure that the environment in which they are located is suitable, but guideline sensitivities are given in Table 5.6.

Medical equipment can also be a significant source of vibration and this should be taken account of in hospital planning. Vibration caused by machinery and plant should comply with the criteria given in HTM 08-01. Direct reference should be made to the manufacturer as to the forcing function and resulting load spectrum generated by the equipment, which can then be used for analysis using similar methods to those described in Section 6.

If laboratory furniture can amplify ambient vibration, special designs may be required for sensitive equipment and machinery

8.3 Light steel floors

Light steel framing is generally based on the use of standard C or Z shaped steel joists produced by cold rolling from strip steel. The steel used in a cold formed joist is relatively thin, typically 1.2 to 3.2 mm, and is galvanized for corrosion protection. The construction of a suspended floor comprising cold formed steel floor joists is similar to that for a floor using timber joists, with floor boarding screw-fixed to the top flange of the individual floor joists, or prefabricated floor cassette panels.

For user comfort, lightweight floors should be sufficiently stiff such that the floor vibration response is due to impulsive excitation. Suitable end connections and flooring materials will improve the overall performance in service. In general, the guidance offered in SCI publication P301^[43] regarding deflection and frequency is acceptable for normal design purposes; this information is reproduced in Section 8.3.1. However, when a response factor assessment is required, the methodology presented in Section 8.3.2 may be adopted. In general, the vibration response of the joists combined with the flooring material will be more significant than the supporting frame.

8.3.1 Stiffness/frequency criteria for floor assessment

The natural frequency of the floor should be limited to 8 Hz within dwellings for the uniformly distributed load case of dead loads plus 0.3 kN/m² (which represents the proportion of the imposed load that may be considered permanent on a residential floor). This is achieved by limiting the deflection of a single joist to 5 mm for this loading condition. In addition, the deflection of the complete floor (i.e. a series of joists plus the flooring material) when subject to a 1 kN point load, should be limited to the values presented in Table 8.4, which are based on tests carried out on a wide range of lightweight floors in North America.

For apartments that are served by a linking corridor, the pace frequencies are likely to be higher than within the dwelling. In this area, the floor should have a minimum frequency of 10 Hz.

For floors constructed using floor boarding (timber boards, chipboard, plywood or cement particle board), which are screw-fixed to the top flange of light steel joists at an appropriate spacing so as to effectively provide continuous fixity, the criterion for the deflection of the complete floor when subject to a 1 kN point load may be applied. In these circumstances, the required second moment of area of the individual floor joists, in cm⁴, may be determined as follows:

$$I_b \geq \frac{L_y^3 \times 10.16}{N_{\text{eff}} \times \delta_j} \quad (56)$$

where:

L_y is the joist span (m)

N_{eff} is the number of effective joists acting with single point load, which may be taken as in Table 8.3

δ_j is the limiting deflection obtained from Table 8.4 (mm).

Table 8.3 Value of N_{eff} for different flooring configurations

Floor configuration	Joist centres	
	400 mm	600 mm
Chipboard	2.5	2.35
Cement particle board	3	2.75
Built-up acoustic floor	4	3.5

Table 8.4 Limiting deflection of floors δ subject to a 1 kN point load at mid-span

Span (m)	3.5	3.8	4.2	4.6	5.3	6.2
Deflection (mm)	1.7	1.6	1.5	1.4	1.3	1.2

Note: Table 6.2 is provided as an aid to assessing the floor joist properties required for estimating purposes. The tables are for joists at 400 or 600 mm centres and for imposed loads of 1.5 kN/m² or 2.5 kN/m².

8.3.2 Response factor analysis

This simplified approach is based on a parametric study of over 80 light steel framed floors using the approach presented in Section 6 and calibrated to test measurements, and may be used when the floor layout is regular as an alternative to the method presented in Section 6. Comparisons of predictions with test measurements are presented in Appendix A.

Natural frequency

Lightweight floor systems exhibit highly orthotropic stiffness ratios. Generally such floors are significantly more flexible in the direction of the span of the joists. In this case, only the mode of vibration due to the motion of the joists need be considered to calculate the fundamental frequency of the floor. This can be done using the methods described in Section 7.2.

When the floor is simply-supported on all four edges, the fundamental frequency, f_0 , may be calculated from:

$$f_0 = \frac{\pi}{2L_y} \sqrt{\frac{EI_b}{m}} \sqrt{1 + \left[2 \left(\frac{L_y}{L_x} \right)^2 + \left(\frac{L_y}{L_x} \right)^4 \right] \frac{EI_s}{EI_b}} \quad (57)$$

where:

L_y is the span of the joists (m)

EI_b is the stiffness of the floor in the direction of span of the joists per unit width, which may be considered to act compositely with the topping if suitable fixings are provided (Nm²/m)

EI_s is the stiffness of the floor in the orthogonal direction to the span of the joists per unit width (Nm²/m)

L_x is the floor width (m)

m is the distributed floor mass, including allowable imposed loads (kg/m²).

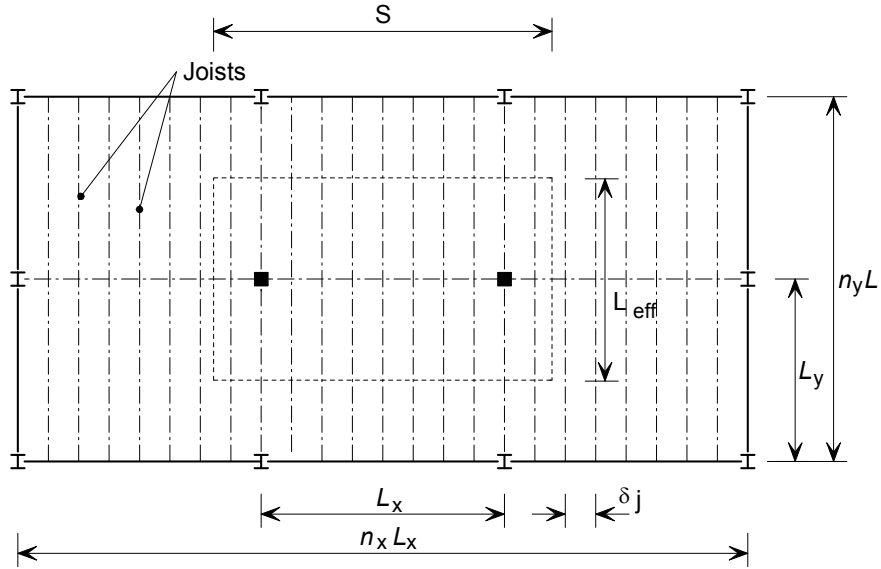

Figure 8.1 Definition of variables used to establish the modal mass

Modal mass:

The modal mass is determined from the calculation of the effective floor area that participates in the motion.

$$M = mL_{\text{eff}} S \quad (44)$$

where:

- M is the modal mass of the lightweight floor (kg)
- m is the distributed mass of the floor, including dead load and the imposed load that can reasonably be expected to exist in service (kg/m²)
- L_{eff} is the effective floor length, defined below (m)
- S is the effective floor width, defined below (m).

Effective floor length:

The effective floor length is defined in the direction of span of the floor joists; it is dependant on the stiffness of the floor joists and on the number of consecutive spans. The following equation may be used to estimate the effective length:

$$L_{\text{eff}} = n_y \left[0.2 L_y^2 - 2.1 L_y + 7.5 \right] \times \sqrt{\frac{I_b}{5.3 \times 10^{-6}}} \quad (58)$$

where:

- n_y is the number of consecutive floor spans in the direction of the floor joists (where $n_y \leq 4$)
- L_y is the floor joist span (m)
- I_b is the second moment of area of the floor joist per unit width, which can be taken as composite with the topping if suitable fixings are provided (expressed in m⁴/m, when all other parameters are expressed in m).

Effective floor width:

The effective floor width is limited to the actual floor width but may be greater than the width of a single bay where multiple bays are used. It is also dependant on the second moment of area of the joists and their transverse stiffness (defined by their spacing). The effective floor width is given by the following equation:

$$S = 0.75(L_x + 1) \times \sqrt{\frac{I_b}{5.3 \times 10^{-6}}} + 5.9(0.6 - s_j) \leq n_x L_x \quad (59)$$

where:

- L_x is the width of the floor bay considered
- I_b is the second moment of area of the floor joist per unit width (expressed in m^4/m , when all other parameters are expressed in m)
- s_j is the spacing of floor support members (m)
- n_x is the number of consecutive floor widths assumed to be acting continuously (where $n_x \leq 4$).

Mode shape factors

For a single floor panel the mode shape factors for the excitation and response points, μ_e and μ_r , can be determined using the procedure set out in Section 7.4, taking z as the distance to the nearest supporting beam in the direction perpendicular to the span of the joists.

Response acceleration

As lightweight floors are designed to be high frequency, the rms acceleration should be calculated from the following expression, which assumes that the floor exhibits a transient response:

$$a_{w,rms} = 2\pi \mu_e \mu_r \frac{185}{M f_0^{0.3}} \frac{Q}{700} \frac{1}{\sqrt{2}} W \quad (60)$$

where:

- μ_e is the mode shape factor at the point of excitation, normalised to the anti-node, as defined in Section 7.4
- μ_r is the mode shape factor at the point of response, normalised to the anti-node, as defined in Section 7.4
- f_0 is the fundamental frequency (Hz)
- M is the modal mass from Equation (44) (kg)
- Q is the static force exerted by an 'average person' (normally taken as $76 \text{ kg} \times 9.81 \text{ m/s}^2 = 746 \text{ N}$)
- W is the appropriate code-defined weighting factor for human perception of vibrations (see Section 7.6), based on the fundamental frequency, f_0 .

For initial design, the factors, μ_e and μ_r , may conservatively be taken as unity. This will effectively place the response at the anti-node of the floor, with the excitation force co-incident.

Frequency weighting

Once the rms acceleration has been calculated it should be frequency-weighted in accordance with the curves for human perception given in BS 6841^[27] (see Section 6.5.1 or 7.6), using $f=f_0$.

Since the weighting factors are all ≤ 1.0 , a factor of 1.0 may conservatively be applied for preliminary design.

Response Factor evaluation

The response factor can be determined by dividing the weighted rms acceleration by a base value of 0.005 m/s² for z-axis vibration and 0.00357 m/s² for x- and y-axis vibrations (see Section 6.5.3).

Acceptability criteria

For lightweight floors, the acceptable level of response due to continuous vibrations is generally higher than that given in BS 6472. From measurements on 103 light steel framed residential floors in Finland^[44], subjective ratings suggest that, for continuous vibrations, a response factor of 16 may be appropriate. The results of this study, and the suggested response factor of 16, are shown graphically in Figure 8.2.

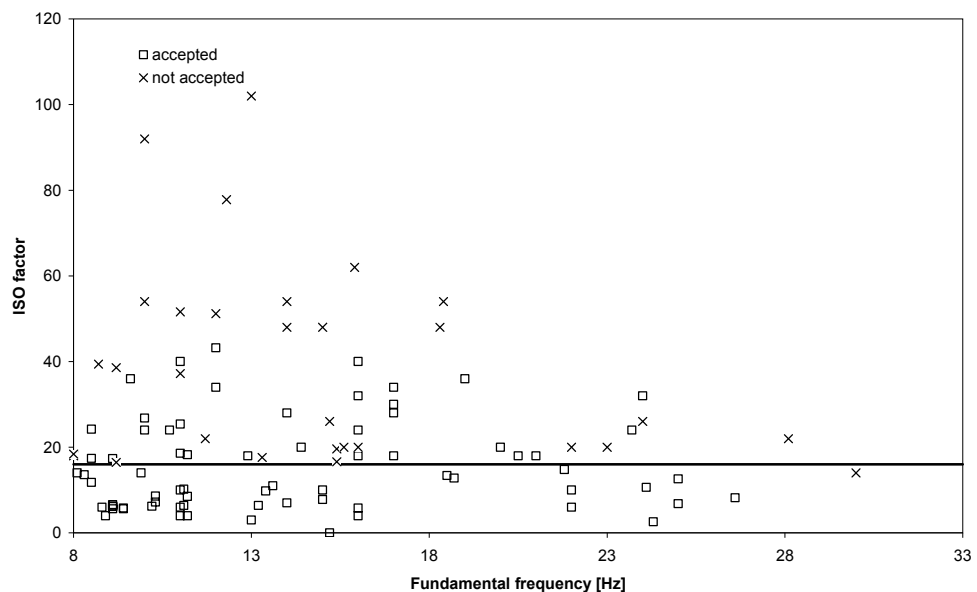

Figure 8.2 Weighted acceleration compared to acceptability

If calculated response values are within the above limit for continuous vibrations, there is no need to consider the effects of intermittent vibrations. However, for the situation where the floor has a higher response than would be acceptable under the conservative limits for continuous vibration, and the design brief permits the use of VDV's, the acceptability should be assessed by considering the intermittent nature of the dynamic forces. This can be done using the same method as presented in Section 6.6. The VDV values that correspond to a "low probability of adverse comment", based on the data in Figure 8.2, are presented in Table 8.5.

Table 8.5 *Adjusted VDV values*

Place	Low probability of adverse comment
Buildings: 16 h day	1.6
Buildings: 8 h night	0.51

8.4 Car parks

In buildings such as car parks, there is an expectation of disturbance from traffic movement and so the dynamic performance is much less important. The human perception of movement in a car park will be less than in other situations because users are either in motion themselves, by walking, or are seated in a car and somewhat isolated from vibration of the floor.

Traditionally, steel-framed car parks have been designed using a minimum acceptable value of fundamental frequency as a sole measure of dynamic performance. Previous guidance suggests that the frequency of the floor (including the concrete slab, primary and secondary beams, where appropriate) should not be below 3 Hz. From a recent study, *Steel-framed car parks*^[45], it is recommended that this frequency limit should be maintained for design, and can be used with confidence. This frequency limit should apply to the floor panel, including all the relevant supporting beams. Note that, in cases where secondary beams span across the building from façade-to-façade, and are framed directly into the columns, the floor frequency may simply be taken as the beam frequency.

For normal steel-framed solutions, a limiting value to the response factor of 65 should be adopted for bare floors with a damping ratio of 1.1% and no imposed load^[45]. No recommendation is given for a full car park because the characteristics are different and it is considered that design based on the criterion for the empty case is sufficient.

This limiting response factor applies to human-induced vibration, but excitation may be caused by impact from cars running over uneven surfaces, speed bumps or discontinuities, such as expansion joints. Careful location of joints and speed bumps together with good detailing and workmanship can reduce the potential response. See *Steel-framed car parks*^[45] published by Corus for more information.

9 REFERENCES

1. EN 1993-1-1:1992: Eurocode 3 Design of steel structures. Part 1.1: General rules and rules for buildings. CEN (Comité Européen de Normilisation), 1992
2. ISO 10137 Bases for design of structures – Serviceability of buildings against vibration
International Organisation for Standardization, 2007
3. BS 6472:1992 Guide to evaluation of human exposure to vibration in buildings (1 Hz to 80 Hz)
British Standards Institution, 1992
4. CLOUGH, R.W. and PENZIEN, J.
Dynamics of Structures
McGraw-Hill, 1993
5. MAGUIRE, J.R. and WYATT, T.A.
Dynamics: an introduction for civil and structural engineers
ICE design and practice guide, Thomas Telford, 1999
6. MEIROVITCH, L.
Fundamentals of vibration
McGraw Hill, 2003
7. TONGUE, B.H.
Principles of vibration
Oxford University Press, 2002
8. YOUNG, W.C. and BUDYNAS, R.G.
Roark's formulas for stress and strain, Seventh Edition
McGraw-Hill, 2002
9. STROUD, K.A.
Advanced engineering mathematics
Palgrave Macmillan, 2003
10. YOUNG, P
Improved floor vibration prediction methodologies. Engineering for Structural Vibration – Current developments in research and practice
Arup Vibration Seminar, Institution of Mechanical Engineers, October 2001
11. American Standard ANSI S3.29-1983: Guide to evaluation of human exposure to vibration in buildings
American National Standards Institute, 1983
12. ISO 2631-1: Mechanical vibration and shock – Evaluation of human exposure to whole-body vibration: Part 1: General requirements
International Organisation for Standardization, 1997
13. PACHI, A and JI, T.
Frequency and velocity of people walking
The Structural Engineer, 83(3), 2005

14. Generalisation of criteria for floor vibrations for industrial, office, residential and public building and gymnastic halls
Final report RFCS project 7210-PR/314, Unit G.5 – RFCS, European Commission, 2003
15. BS EN 1990:2002: Eurocode. Basis of structural design
British Standards Institution, 2002
16. BACHMANN, H. and AMMANN, W.
Vibrations in Structures: Induced by Man and Machines
IABSE, 1987
17. RAINER, J.H., PERNICA, G. and ALLEN, D.E.
Dynamic loading and response of footbridges
Canadian Journal of Civil Engineering, 15(1), February 1988, pp 66-71
18. ALVES, N.K.C., ROITMAN, N. and MAGLUTA, C.
Dynamic response under human movements
Materials and Structures, 32, February 1999, pp 31-37
19. KERR, S.C.
Human induced loading on staircases
PhD thesis, University of London, 1998
20. ELLIS, B.R.
On the response of long-span floors to walking loads generated by individuals and crowds
The Structural Engineer, 78(10), May 2000, pp 17-25
21. JI, T. and ELLIS, B.R.
Floor vibration induced by dance-type loads: theory
The Structural Engineer, 72, (3), February 1994, pp 37-44
22. ELLIS, B.R. and JI, T.
The response of structures to dynamic crowd loads. BRE Digest 426,
British research Establishment, 2004
23. BS 6399-1:1996 Loadings for buildings. Code of practice for dead and imposed loads
British Standards Institution, 1996
24. HICKS, S.J., BROZZETTI, J., REMY, B. and LAWSON, R.M.
Dimensionnement des Planchers Mixtes Acier Beton vis-à-vis des Vibrations
Construction Metallique No.1, pp 3-31, 2003 (*in French*)
25. HICKS, S.J. and LAWSON, R.M.
Design of composite beams using precast concrete slabs (SCI P287)
The Steel Construction Institute, 2003
26. ISO 2631-2: Evaluation of human exposure to whole-body vibration
Part 2: Continuous and shock-induced vibration in buildings (1 to 80 Hz),
International Organisation for Standardization, 2003
27. BS 6841:1987 Guide to measurement and evaluation of human exposure to whole-body mechanical vibration and repeated shock
British Standards Institute, 1987

28. GRIFFIN, M.J.
Handbook of human vibration
Academic Press Ltd., 1996
29. Health Technical Memorandum 08-01: Acoustics
The Stationery Office, 2008
30. Considerations in cleanroom design
IEST-RP-CC012.1 Institute of Environmental Sciences and Technology,
Rolling Meadows, Illinois, 1998
31. DIN 4150 Vibrations in civil engineering: Part 2: Effects on people in
buildings
German Institute for Standardization, Berlin, 1975 and 1999 (*in German*)
32. VDI 2057 Effect of mechanical vibrations on human beings: Part 2:
Evaluation
Institution of German Engineers, Dusseldorf, 1987 (*in German*)
33. WYATT, T.A.
Design guide on the vibration of floors, (SCI P076)
The Steel Construction Institute, 1989
34. MURRAY, M.M., ALLEN, D.E. and UNGAR, E.E.
Floor vibrations due to human activity
AISC/CISC Steel Design Guide Series 11
American Institute of Steel Construction, 1997
35. ELLINGWOOD, B.
Structural serviceability: Floor vibrations
ASCE Journal of Structural Engineering, 1984
36. ELLIS, B.R.
Serviceability evaluation of floor vibration induced by walking loads
The Structural Engineer 79(21), November 2001, pp 30-36
37. GORDON, C.
The control of vibration in buildings
BBN Laboratories, Cambridge, MA, 1988
38. 2003 ASHRAE Handbook
HVAC applications: Chapter 47 sound and vibration control
ASHRAE, 2003
39. PRATT, K.
Floor Vibration: Requirements for laboratories and microelectronics
facilities. Seminar "Engineering for Structural Vibration – Current
developments in research and practice"
Institution of Mechanical Engineers, 4 October, 2001
40. Dynamic Performance requirements for permanent grandstands subject to
crowd action: Interim guidance on assessment and design
The Institution of Structural Engineers, 2001
41. HICKS, S.J.
New tests demonstrate superior performance of steel-framed floors
New Steel Construction, 13(10), 2005

42. HICKS, S.J.
The real vibration performance of modern steel-framed floors
New Steel Construction, 13(6), 2005
43. GORGOLEWSKI, M.T., GRUBB, P.J. and LAWSON, R.M.
Building design using cold formed steel section: Light steel framing in residential construction (P301)
The Steel Construction Institute, 2001
44. TALJA, A., TORATTI, T and JÄRVINEN, E.
Classification and acceptance limits of human-induced floor vibrations in residential buildings. VTT Technical Research Notes 2124
VTT (Technical Research Centre of Finland), 2002
45. Steel-framed car parks
Corus Construction and Industrial, Corus, 2004
46. HICKS, S.J.
The vibration performance of steel-frames floors
The Structural Engineer 83(21), November 2005, pp 22-23
47. WILLIAMS, M.S. and FALATI, S.
Floor vibration tests on first level of the SCI headquarters, Silwood Park
Report No. 2185/98, University of Oxford, Oxford, November 1998.
48. NASHIF, A.D., JONES, D.I.G. and HENDERSON, J.P.
Vibration damping
John Wiley & Sons, 1985
49. MAIA, N.M.M., SILVA, J.M.M., HE, J., LIEVEN, N.A.J., LIN, R. M., SKINGLE, G.W., TO, W.M. and URGUEIRA, A.P.V.
Theoretical and experimental modal analysis.
UK: Research Studies Press Ltd. and John Wiley and Sons, 1997
50. EWINS, D.J.
Modal testing: theory, practice and application, 2nd Edition
UK: Research Studies Press Ltd. and John Wiley and Sons, 2000
51. McCONNELL, K G.
Vibration testing theory and practice
John Wiley and Sons, New York, 1995
52. REYNOLDS, P. and PAVIC, A.
Impulse hammer versus shaker excitation for the modal testing of building floors
Experimental Techniques, Society for Experimental Mechanics, 24(3), 2000, pp39-44
53. REYNOLDS, P. and PAVIC, A.
Quality assurance procedures for the modal testing of building floor structures
Experimental Techniques, Society for Experimental Mechanics, 24(4), 2000, pp36-41
54. BLAKEBOROUGH, A. and WILLIAMS, M.S.
(2003) Measurement of floor vibrations using a heel drop test.
Structures and Buildings, Proceedings of the ICE, 156(4), pp367-371

55. BROWNJOHN, J.M.W., PAVIC, A. and OMENZETTER, P.
A spectral density approach for modelling continuous vertical forces on pedestrian structures due to walking
Canadian journal of civil engineering, 31(1), February 2004, pp65-77
56. BROWNJOHN, J.M.W. and PAVIC, A.
Vibration control of ultra-sensitive facilities.
Structures and Buildings (Special issue on vibration serviceability),
Proceedings of the ICE. Vol. 159. October 2006.
57. ERIKSSON, P.E.
Vibration of low-frequency floors - Dynamic forces and response Prediction. PhD Thesis (in English).
Chalmers University of Technology, Goteborg, Sweden, 1994
58. BISHOP, N.W.M., WILLFORD, M and PUMPHREY, R.
Human induced loading for flexible staircases
Safety Science 18, 1995, pp261-276.

APPENDIX A Comparison of analysis methods with measurements

Over the last eight years, the SCI has been involved in UK and European-sponsored research projects on floor vibrations^[14,24,46], which has resulted in *in situ* tests being undertaken on a wide range of real floors in the commercial, health and residential sector. The reasons for these tests have been to:

- provide a better understanding of the vibration behaviour of steel-framed floors
- demonstrate the conservatism that exists within existing design guides when compared to measurements from real floors
- develop the improved design rules that are presented within this publication.

A selection of floors that have been subjected to vibration tests is shown in Table A.1. This table presents the measured fundamental (first mode) frequency and the corresponding worst-case response factor from walking activities carried out on the test floors. Results specifically regarding testing of hospital floors are given in Section A.3.

A.1 Test procedures

To obtain as much experimental information as possible on the floors under investigation, wherever possible, the test procedure was divided into two parts by conducting impact or shaker tests to determine the free vibration characteristics of the floors, prior to response measurements through controlled walking tests (an explanation of the procedure for each of these test types is given in Appendix B). For the walking tests, the rms acceleration was determined using the worst 1-second portion of the acceleration time-history.

A.2 Results from testing office floors

Table A.1 presents the measured fundamental (first mode) frequency and the corresponding worst-case response factor from walking activities carried out on the test floors. The wide scatter of fundamental frequencies reflects the range of floor finishes and structural configurations tested.

A number of interesting observations may be made about these test results. For Floors O1, O2 and O3, which utilised long-span composite construction, the fundamental floor frequency was very close to the frequencies of some higher modes of vibration. For example, above the value of 4.13 Hz, Floor O1 had frequency modes at 4.3, 4.6, 5.7, 6.2 and 8.1 Hz. As a result of this, it was typical that in addition to the fundamental frequency mode, these higher modes of vibration were also excited by the walking tests. For example, in the case of Floor O1, the design (worst case) value for the acceleration response was found when the 4.13, 6.2 and 8.1 Hz frequency modes were excited by the second, third and fourth harmonic component of a 2.05 Hz walking frequency.

Table A.1 Measured dynamic properties of eight composite floors

Floor	Project	Floor type	Finishes	f_1 (Hz)	ζ (%)	R
O1	Paris Office Area 1	13.8 m span cellular secondary beams spaced at 2.7 m centres with 120 mm deep composite slab	A	4.13	1.28	5.84
O2	Paris Office Area 1	As above	C	4.19	1.55	2.62
O3	Paris Office Area 3	16.7 m span cellular secondary beams spaced at 2.7 m centres with 120 mm deep composite slab	C	4.44	1.40	8.34
O4	SCI Headquarters ^[47]	6 m span UB secondary beams spaced at 2.5 m centres with 130 mm deep composite slab	E	8.47	4.68	3.85
O5	Cambridge Laboratory	6 m span ASB's spaced at 6.6 m centres with 296 mm deep composite slab (<i>Slimdek</i> ® floor)	A	11.38	2.93	3.88

Notes:

A = Services

C = False floor and services

E = False floor, Services, Furniture, Partitions

Response factors are related to the base value for z-axis vibrations, as given in BS 6472, and are frequency-weighted for vision (W_g curve)

For floors which possess a fundamental frequency greater than 10 Hz, it is presently assumed that the floor will exhibit an impulsive response (see Section 2.4.3). For the walking test results presented here, only Floor O5 falls within this category. This assumption about floor response agreed reasonably well with that which was observed in the walking tests. In the measured results for Floor O5 the response was characterised by successive peaks in the acceleration-time history (corresponding to each footfall of the walker) that decayed rapidly.

As well as acceleration measurements on Floors O1, O2 and O3, crude subjective ratings for the floor response were also recorded while the walking tests were underway. In no case during normal walking did any of the subjective ratings suggest that the floor vibrations were annoying. The only adverse comment occurred when the forcing function comprised of an individual jumping on the spot at 2.0 Hz (comparable to a loading which would be expected on an aerobics or dance floor, see Section 8.1).

A.3 Results from testing hospital floors

To complement the tests on office floors, vibration tests on composite floors in steel-framed hospital buildings have been undertaken during this research. These tests have confirmed that the real performance of composite floors often surpasses the requirements given by HTM 08-01 as well as the current methods employed to calculate response, including the methods in this publication. This is due to the assumptions made about the mass that will be present in service, and the effect of partitions on the behaviour of the floor.

The tests were undertaken according to the procedure given in Appendix B. An image of one of the multi-input multi-output (MIMO) shakers used by the University of Sheffield in one of the operating theatre areas of Floor H4 is shown in Figure A.1.

As can be seen from Table A.2, all the floors easily satisfied the performance limit shown in Table 8.1 for an operating theatre environment, out-performing the HTM 08-01 requirements by a factor of between 2 and 4.

Table A.2 *Response factors for tested operating theatre floors due to excitation from a corridor (bracketed values are worst case values for the whole floor)*

Floor	Project	Floor type	Finishes	f_1 (Hz)	ζ (%)	R
H1	Hospital 1 Operating Theatre	Composite floor, 300 mm slab; 13.2 m span, 625 mm deep cellular secondary beams spaced at 3.6 m centres; 7.2 m span 571 mm deep cellular primary beams	A	9.01	2.75	0.25 (2.70)
H2	Hospital 1 Operating Theatre	As above	D	6.38	3.40	0.34 (0.70)
H3	Hospital 2 Operating Theatre	Composite floor, 175 mm slab; 15 m span fabricated plate girders with web openings spaced at 2.5 m centres; 7.5 m span 700 mm deep cellular primary beams	A	4.88	0.50	0.58 (4.76)
H4	St Richards Hospital, Chichester	<i>Slimdek</i> floor, 335 mm slab + 80 mm screed; 5.9 m span, 300ASB153 spaced at 5.5 m centres	E	9.50	1.30	0.29 (1.10)
H5	Sunderland Royal Hospital	<i>Slimdek</i> floor, 337 mm slab; 6.8 m span, 300ASB185 spaced at 5.7 m centres	B	9.60	4.80	0.54 (1.16)

Notes:

A = Services

B = Partitions and services

D = Partitions, services and false ceiling

E = False floor, services, furniture, partitions

Response factors are related to the base value for z-axis vibrations, as given in BS 6472, and are frequency-weighted for hand and vision (W_g curve)

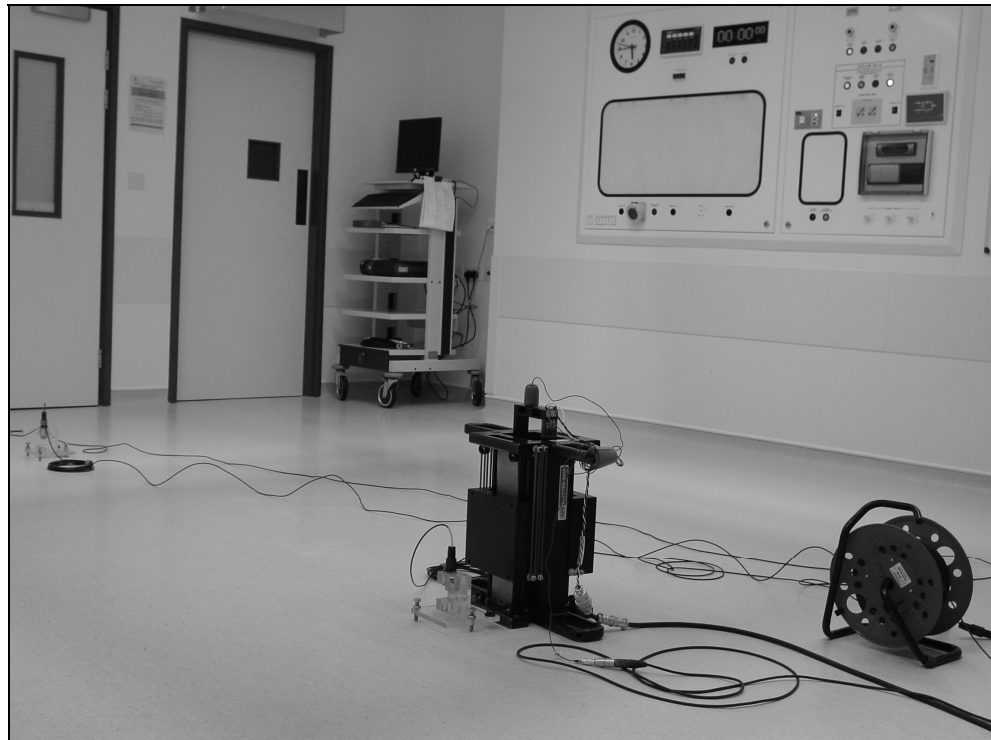

Figure A.1 *Electro-dynamic shaker within operating theatre to floor 4*

A.4 Comparison of predictions with measurements

The following figures present the results from the 10 composite floors presented in Table A.1 and Table A.2. The floors have been analysed using the methods described in both Section 6 and Section 7, using the measured critical damping ratios for the first mode of vibration of each floor. The results of these analyses are presented in Figure A.2 and Figure A.3:

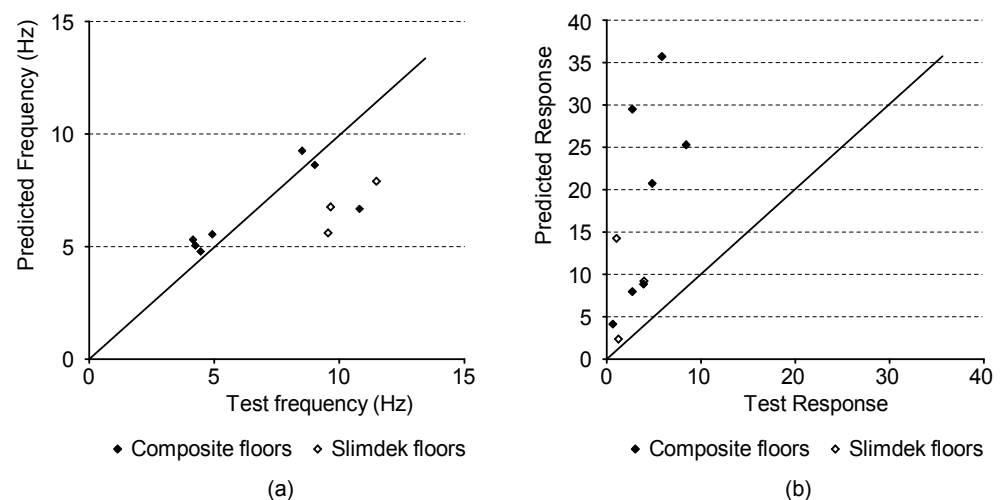

Figure A.2 *Comparison of simplified method results with test results for (a) first mode frequency and (b) response factor*

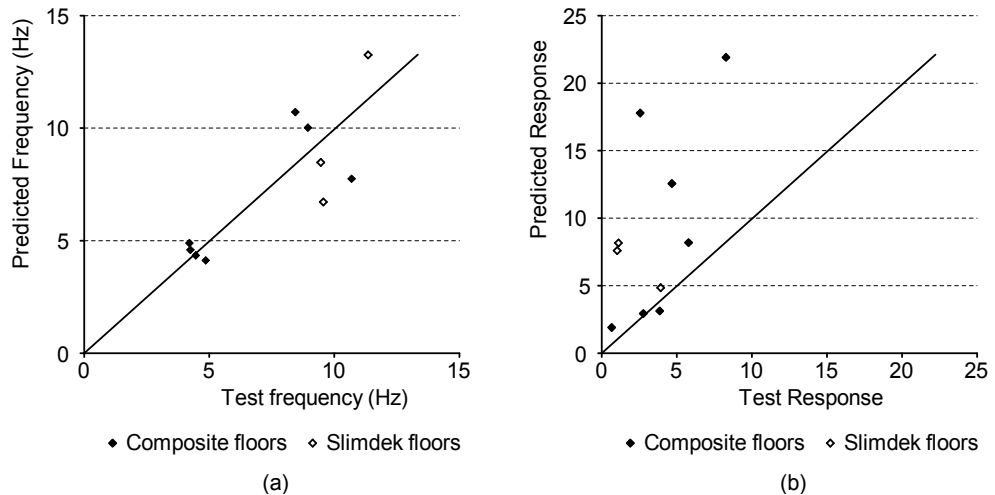

Figure A.3 Comparison of finite element analysis results with test results for (a) first mode frequency and (b) response factor

Figure A.2 and Figure A.3 show that in almost all cases the predicted results are conservative relative to the test results. The exception (Floor O4) is only slightly unconservative for the finite element analysis, and this is due to the walking frequency required to generate this response (approx 3 Hz) being much greater than would normally be expected. The large amount of conservatism for some floors is a result of partitions restricting certain modes from being active (this can be seen from the predicted frequencies being significantly lower than the test frequencies) and hence the modal damping being inappropriate, or differences in the excitation and response points used in the test and in the analysis.

To show the impact of the excitation point being remote from the response point, a further set of results are presented in Figure A.4 for the hospital floors; in these cases the responses in the operating theatres to walking in neighbouring corridors is compared with predictions based on the general method in Section 6.

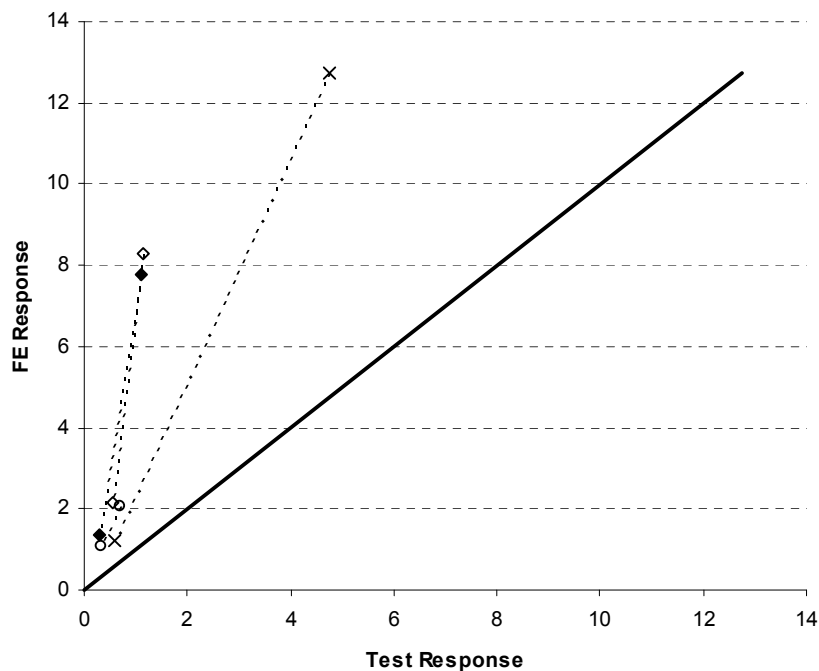

Figure A.4 Corridor to operating theatre response for finite element analysis

Figure A.4 shows the overall maximum response and the corridor to operating theatre response for each of the four hospitals (for Hospital 1 this was only performed with the floor in its finished state, i.e. floor H2). These results show that consideration of the likely position of walking paths and sensitive areas can play a significant role in reducing the response of a floor.

A.5 Lightweight floors

In addition to the tests on composite floors, tests were also performed on two floors suitable for use with the method given in Section 8.3. Both floors consisted of steel joists at 0.6 m centres; details of the floors and the test results are given in Table A.3.

Table A.3 Details of tested lightweight floors

Floor	Project	Floor type	Finishes	f_1^* (Hz)	ζ (%)	R
L1	Community centre	200 mm deep light steel joist supporting 13 mm chipboard. 4 consecutive 6.68 m spans, floor width of 7.2 m	B	14.4	2.8	35.5
L2	Semi-detached house	220 mm deep light steel joist supporting 22 mm chipboard. One 4.88 m span, floor width 3.15 m	E	14.0	6.6	16.5

Notes:

B = Partitions and services

E = Services, furniture, partitions

* Only local modes of vibration are considered, as these have the lowest modal masses and hence higher response factors

The results from both the simplified method and the finite element method are shown in Figure A.5.

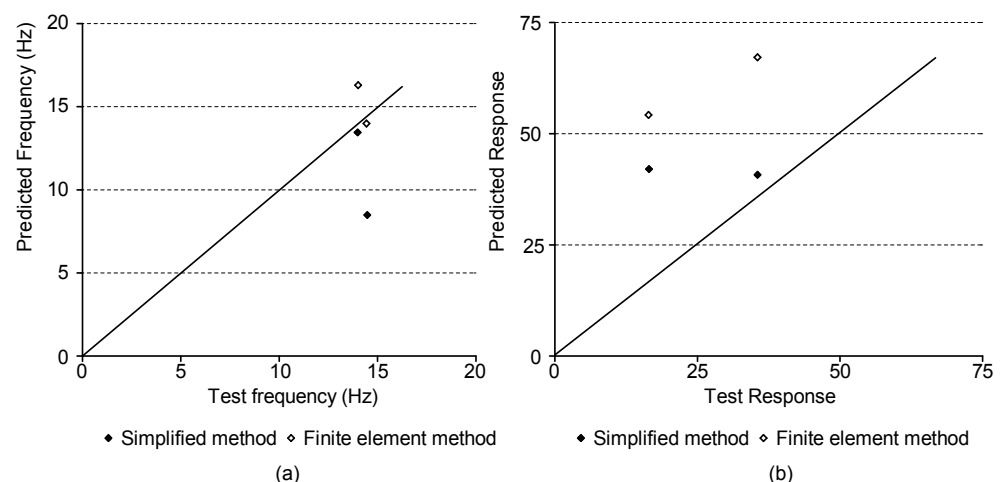

Figure A.5 Comparison of simplified method and finite element analysis results with test results for (a) first mode frequency and (b) response factor

Partitions, though present in the tested buildings, were not included in the FE models as the support that they provide is difficult to accurately model. Consequently, the response factors obtained by the finite element results do not

match those found in the tests. However, by adding in an “effective partition”, i.e. a steel plate along the partition lines, and varying its dimensions, the frequencies of the model could be made to match those found in the tests; the subsequent response analysis gave much more accurate answers (e.g. for L2, $R=16.2$). However, the required dimensions of this effective partition depends on the partition type and connection details, so inclusion of such a partition in a FE model should not be made unless test data is available to verify this effect.

For the simplified method, the spans are taken between partitions, and so the response factors obtained are closer to the test results. The calculated fundamental frequency for floor L1 is lower than the test results, and this implies that some of the frequencies were constrained in the tested building.

APPENDIX B Retrofit and remedial strategies

B.1 Evaluation of floor vibration problems

B.1.1 Determining when to evaluate

Often vibration problems are only evident after they occur. Structural engineers involved in the design or evaluation of a building should be aware, and should advise clients, that a change of use, such as reusing the building for rhythmic activities or removing partitions, may result in problems that may be difficult to resolve in the post construction phase.

B.1.2 Source of vibration

It is important to determine whether the vibration problem is caused by walking, rhythmic activities, equipment vibration, or sources external to the building that transmit vibration through the ground. Sometimes low-frequency noise is interpreted by occupants as vibration. Many remedial measures will be significantly dependant on the source of the vibration and its manner of occurrence. Not all remedial solutions will be appropriate for different types of vibration although many are universal. Establishing the source of the vibration will determine whether the solution should focus on the source itself or on its effects.

B.1.3 Evaluation tools

Possible evaluation approaches are:

- Subjective testing
- Calculations
- Vibration measurements

A subjective test is particularly useful prior to a change of use of an existing floor. For example, the effect of altering a room to allow for aerobic or rhythmic activity can easily be evaluated by performing a typical aerobic function while recording the resulting vibration. Walking tests carried out on the floor will deliver accurate values for the actual activity taking place and will therefore be the most relevant information that can be extracted. For such a test, a range of walking frequencies should be considered. Subjective testing should only be utilised when an engineer is certain that the ultimate strength of the floor will not be compromised either by the test or by the activity that might be subsequently allowed as a result of a satisfactory result of tests.

Calculations, as typically described in the text of this guide can be used to evaluate the dynamic properties of the structure and to estimate the likely vibration response caused by given dynamic loadings. While not as reliable as subjective testing or measurements, calculations have an advantage that they may be used as an evaluation technique at both the design stage and the post-construction stage.

Vibration measurements can determine the dynamic properties, as well as the true response of the structure to human activities. No other form of evaluation will deliver more accurate information regarding the structural performance than

physical testing. Measurement will also be able to give information on the range of possible modal frequencies of the structure including their value, dispersion, and contribution to the vibration. This information is important in the case of remedial measures that seek to improve damping. Recommendations for a standard testing procedure are given in Appendix C.

B.2 Retrofit and remedial measures for Steel-concrete construction

Remedial action is often expensive and sometimes practicably impossible within realistic physical constraints. In some situations, it may be feasible to use measures which will merely reduce the annoyance associated with the vibration instead of altering the nature or extend of the vibration itself. Such measures include removing or reducing associated annoyance factors such as noise caused by vibrating components, altering the timing of the problem-causing activity, or changing the architectural layout to move occupants away from problem areas.

B.2.1 Changing mass

Changing floor mass as a retrofit measure is usually not effective. Increasing floor mass will decrease the dynamic response but also decreases the natural frequency and, as a result, may increase the perceptual awareness of the vibration.

B.2.2 Altering flexibility

Vibrations due to walking or rhythmic activities can be reduced by increasing the floor stiffness and, consequentially, the natural frequency. The benefit of stiffening can be estimated by applying the design criteria recommendations in this guide. For vibrations due to walking, the components with the greatest flexibility will benefit most from stiffening. One effective method, where it is practical to do so, is to install extra columns in the structure to interrupt the span of flexible members. This will lower deflection and hence increase frequency in these areas. Alternatively, the support member's section profile may be stiffened directly by either replacement, or local treatment such as welding plates to the underside of the bottom flange.

B.2.3 Altering damping

For steel and concrete construction, floor vibrations can be reduced by increasing the damping of the floor system. Damping in an existing floor depends primarily on the presence of non-structural elements such as partitions. The addition of non-structural components that interact with the floor structure can be effective. This is especially true if there is only a relatively small number of such components in the existing structure. There are three principal methods of increasing damping:

- Changing the placement of non-structural components such as partitions
- Provision of tuned mass dampers
- Provision of specialist damping materials

Changing the position or increasing the number of non-structural components will aid the damping of a floor system. Unfortunately, as damping is an extremely variable characteristic, it is impossible to accurately quantify the exact improvement which will be provided by increasing such components.

Generally performance testing will be required to establish the effectiveness of these remedial measures.

Tuned mass dampers, which exhibit a passive control of floor movement, may be utilised to reduce the response of the floor to forcing actions such as footfall. A tuned mass damper (TMD) is a mass attached to the floor structure through a spring and damping device. A TMD is effective, however, only if the natural frequency of the TMD closely correlates with that of the troublesome mode of floor vibration. TMDs which are initially tuned to the floor vibration modes may become out-of-tune due to changes in the floor's natural frequencies resulting from alterations to the floor characteristics or movement of materials locally. It should be noted that TMDs have a limited frequency range where they are effective. As a consequence of this, a floor with several problematic frequencies may need several TMDs to reduce the floor response. Typically, the mass of a TMD will be between 2% and 5% of the modal mass for each mode that needs tuning^[16].

Specialist materials are generally used in constrained layer damping systems. Materials with high energy dissipation are sandwiched between the existing structure and an additional sheet of metal, and the strains that are subsequently induced in the layer (both direct tension/compression and shear) dissipate energy by hysteresis. Specialist advice should be sought to determine whether this method of damping is appropriate and beneficial (e.g. the effectiveness of the material may be dependant on temperature or the amplitude of the strains); further information can be found in Nashif, Jones and Henderson^[48].

B.3 Retrofit strategies for machine induced vibrations

Machines used for mechanical systems or for production processes apply dynamic forces to the floors that support them. The types of dynamic forces depend on the nature of the machinery. There are three general types of machinery: rotating components that generate a single-frequency harmonic force; those with the oscillating components that generate multi-frequency harmonic components; and those with impactive forces that generate transient impacts. All three types of forces can produce floor vibrations, which may cause discomfort to the building occupants, disrupt vibration sensitive processes and possibly cause damage to the building or to the machinery. If forces are impactive or are harmonic at frequencies greater than 20 Hz, noise can also be transmitted through the building components, causing discomfort to the occupants. The problem of noise should be treated separately from vibration, because the remedial measures for the two problems differ substantially.

B.3.1 General strategies

Remedial measures to reduce vibration problems due to machinery include isolation, increase in inertial mass, relocation, floor stiffening, and alterations to the machine itself, such as reducing eccentric forces. Isolation is the most common and effective remedial measure for small machines with rotating and oscillating components. Isolation combined with an increase in inertial mass is often effective for heavy machines. The isolation is achieved by separating the machine from the building structure, or mounting the machine on resilient supports. Increasing floor stiffness, relocation to a stiffer floor, or adding inertial mass, can be effective for reducing the effect of machine induced

vibration of the structure. The following section discusses the most common remedial measure, base-isolation.

B.3.2 Base-isolation of machinery

Vibrations produced by machinery with rotating or oscillating components can usually be isolated from the structure by mounting the machines on a concrete slab placed on resilient supports that rest on the floor^[34]. The slab provides resistance to the vibration and utilises a low centre of gravity to compensate for dynamic forces such as those generated by large fans (see Figure B.1).

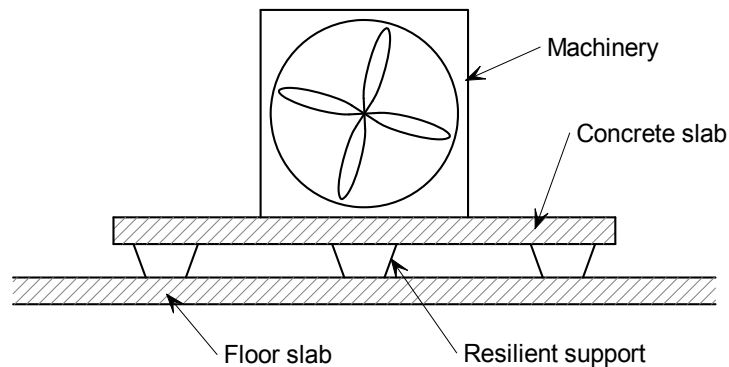

Figure B.1 *Base-isolation slab and supports*

For machinery generating small dynamic forces, a “housekeeping” slab is sometimes used below the resilient mounts to provide a rigid support for the mounts and to keep them above the floor. The mounts are easier to clean and inspect in this position. This slab may in turn be mounted on pads of precompressed glass fibre or neoprene which rest on the floor slab.

The natural frequency of the total mass on the resilient supports must be well below the lowest forcing frequency generated by the machine. The required weight of the concrete slab depends on the total weight of the machine and the magnitude of the dynamic forces.

Simplified theory shows that for 90-percent vibration isolation, the equipment supported on resilient mounts should have a natural frequency of about one-third the lowest forcing frequency of the equipment. Further guidance can be found in the AISC/CISC DG11^[34].

APPENDIX C Dynamic testing of building floors

This Appendix was written by Professor Aleksandar Pavic and Dr Paul Reynolds, both of Sheffield University

For engineers who are familiar with the basics of experimental dynamic testing but are unfamiliar with its application to building floors, published material on floor testing may be quite confusing. This Appendix is for those engineers who, already familiar with testing, are trying to plan, commission and perform floor dynamic testing. The information in this Appendix is highly specialised and should not be viewed as an introduction to testing.

Since the early 1990s, rapid advances in the instrumentation and digital data acquisition and processing have enabled a transfer of the advanced vibration measurement and testing technologies from mechanical and aerospace engineering disciplines to civil structural engineering applications. These technologies are nowadays available to test floors. In this context the purpose of dynamic testing is to: (1) measure modal properties of floors by means of modal testing; (2) measure the actual dynamic responses of floors to the dynamic loading specified in design; (3) post-process these responses in accordance with the specified national or international standard to obtain a relevant response parameter; and (4) rate this parameter against an acceptance criterion specified for the floor design.

C.1 Modal testing

Modal testing or experimental modal analysis (Maia *et al*^[49]) is a complex technology whose aim is to establish experimentally modal properties of test structures. It is based on measuring and post-processing dynamic responses of a test structure at one or more locations. Two types of floor modal testing exist: when the excitation force creating these responses is not measured and when it is measured.

C.1.1 Modal testing of floors without measuring the excitation force

In the case of floors, three types of tests without measuring force were common in the past: (1) ambient vibration survey (AVS), (2) heel-drop excitation and (3) rotating mass shaker excitation.

AVS

The AVS is based on the assumption that the floor dynamic excitation is provided by the environment in which it resides and is broadband, having energy more or less evenly distributed within the frequency range of interest. Vibration responses to this kind of excitation are acquired over a grid of test points covering in sufficient detail the floor area of interest. This grid needs to be dense enough to describe floor mode shapes of interest in sufficient detail, otherwise a problem of so called *spatial aliasing* could occur, leading to incorrect identification of mode shapes. Figure C.1 shows a typical test grid which was used for modal testing of a real-life floor.

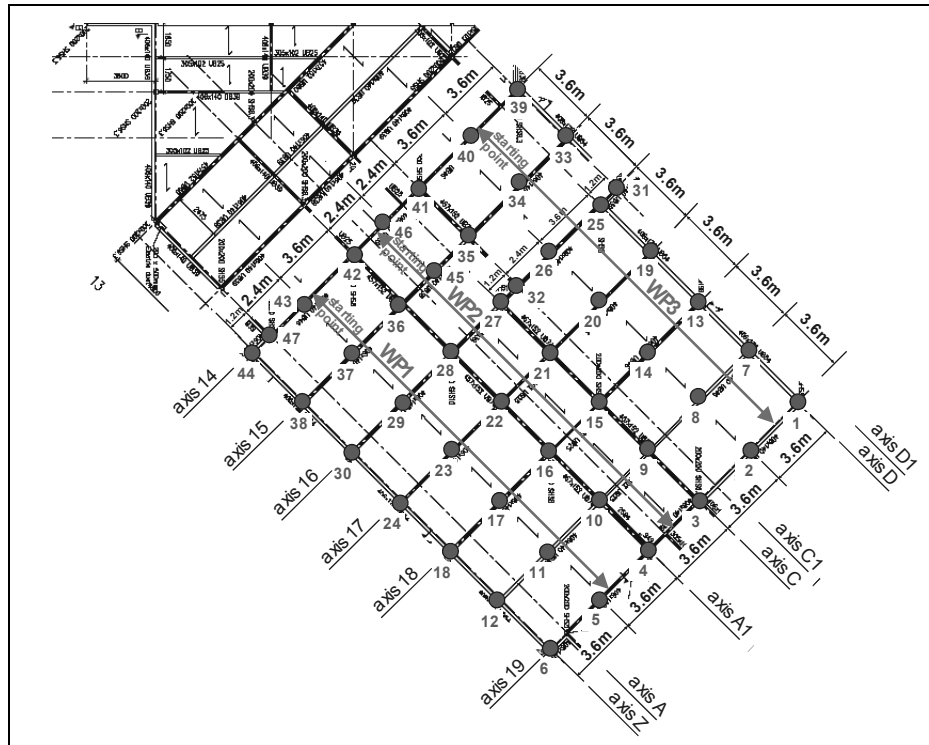

Figure C.1 Typical test grid comprising 47 test points (TPs) used for testing a 3-bay composite steel-concrete floor.

If there are more test points than transducers, which is often the case, then the whole test grid needs to be covered in several phases by different measurement setups. A number of reference grid locations are then selected and transducers at these points are kept at the same location in all setups. The rest of transducers are moved between setups, hence these transducers are termed ‘travellers’, so that by the end of the last setup, ambient vibration responses at all test grid points have been measured. In each setup, floor responses are acquired simultaneously at all reference and traveller transducers, meaning that at least a dual- or preferably multi-channel data acquisition is required.

For typical floor applications and their natural frequencies, data acquisition for each location/setup should not last less than 15 minutes. The dual- or multi-channel digital data acquisition is nowadays usually performed using a spectrum analyser. Each setup must have a measurement from all references (which do not change between setups) and the corresponding traveller transducers (which change between setups). All acquired time histories from all setups are then processed yielding natural frequencies, operational deflection shapes corresponding to natural frequencies (which are very close to mode shapes) and modal damping ratios.

The data processing is typically performed using specialist software. Theoretically speaking, modal mass cannot be estimated from AVS. It is important to note that to measure floor modes of vibration via the AVS, the following two conditions must be satisfied: modes of interest must be excited and the reference transducers must be away from nodal points/lines of the mode being measured. It should be noted here that more or less symmetrically distributed ambient dynamic loading may struggle to excite modes with more or less anti-symmetric mode shapes.

Heel-drop

Excitation in heel-drop tests is provided by a single person raising himself on the balls of the feet, and dropping onto the heels, thus providing an impact. The multi-modal decaying response to this impulsive broadband excitation can be measured at one or more locations simultaneously. The response data can be used to estimate modal properties in a manner similar to AVS, using one or more channels.

One of the biggest problems with the heel-drop test in the past was its usage to estimate damping from the multi-modal decaying response to which several closely spaced modes of vibration contributed. Such decaying responses were curve-fitted using single-degree-of-freedom models (SDOF) to estimate damping of the fundamental mode of vibration. Due to rapidly decaying multi-modal response, where contribution of modes having higher frequencies diminished quickly, this approach usually resulted in relatively high damping when a single exponentially decaying function (i.e. an SDOF model) was inappropriately used to curve-fit the whole of the multi-modal response.

Rotating mass shaker

In the rotating mass exciter, two masses rotate in a vertical plane at the same speed but in opposite directions, so that the horizontal components of their inertial forces cancel, leaving only a sinusoidally varying vertical force. Harmonic forces at particular frequencies generated by the rotating mass shaker excite floor harmonic responses at the same frequencies. These are then measured simultaneously at one or more grid points on the floor and their amplitudes recorded. The excitation frequency is then changed and the corresponding harmonic response amplitudes are again recorded. By repeating this process for a number of frequencies and plotting the recorded amplitudes against the frequencies for each test point, it is possible to estimate likely natural frequencies which correspond to the increase in amplitudes of harmonic responses. An SDOF half-power method is typically used to estimate damping. This process is slow and prone to errors due to low frequency resolution obtainable and SDOF curve-fitting in the case of closely spaced modes of vibration.

A common feature in all these modal testing methods where the excitation force is not measured, is that modal properties tend to be less complete and reliable. This is because the lack of measurement of forces requires a number of assumptions to be made to enable extraction of modal properties, and some of them may not be correct, leading to considerable errors. This is particularly so when floor modal properties in such tests are estimated using SDOF curve-fitting techniques. The reason is the presence and interaction of closely spaced modes of vibration, which are to be expected in floors due to their repetitive geometry and, often, orthotropy. These methods were used commonly in the past, but are rapidly becoming obsolete and replaced by modal testing methods where the excitation force is measured.

C.2 Modal testing of floors with measurements made of the excitation force

Two types of tests are commonly performed: (1) impact testing (using an instrumented hammer or a heel-drop on an instrumented force plate) and (2) shaker testing (using a single shaker or an array of shakers distributed over the floor area). A grid of test points similar to the one in Figure C.1 is developed over the floor area of interest and responses to known excitation are measured.

A common feature of both types of test is that they yield a set of frequency response functions (FRFs) via a process of dual-channel digital signal processing, which is described in great detail elsewhere^[49,50]. For pairs of excitation and response locations, the FRFs provide a ratio of the harmonic response and the corresponding excitation at each frequency of interest, including the phase shift between them.

By virtue of signal post processing based on digital Fourier transforms, it is possible to obtain the ratio of harmonic response despite the fact that the actual excitation applied was not harmonic. The FRF phase shift information is crucial for obtaining more reliable modal properties by curve-fitting of FRFs as mathematical models used for such curve fitting contain all four key modal properties: natural frequencies, modal damping ratios, mode shapes and modal masses. Through the computer-based curve fitting process, these properties are systematically adjusted until the difference between the experimental and mathematically generated FRFs is minimised over the frequency range of interest. The ability to estimate experimentally FRFs, and curve-fit them using all four modal properties, is the main advantage of the modal testing methods where the force is measured over those where it is not.

Instrumented impact testing

In the case of an instrumented hammer, the force is measured by a load cell installed at the tip of the hammer. The excitation usually moves from point to point while the responses are measured at a number of stationary reference points. At each point, the excitation is applied several times to average out the effects of extraneous noise^[51]. To minimise the seriously detrimental effects of unmeasured extraneous excitation of floors, the FRF-based modal testing of floors should be performed on an unoccupied floor structure, preferably in an unoccupied building. Therefore, for floors in operation or under construction, night and weekend work is often the only option to carry out the testing. Figure C.2 shows a typical setup for hammer testing. Both the excitation and the corresponding responses are then processed yielding a set of FRFs.

Advice on hammer testing of floors is given by Reynolds and Pavic^[52,53]. Blakeborough and Williams^[54] described a heel-drop test using an instrumented force plate to obtain FRFs of a floor structure.

A problem with impact testing of floors using measured impulses is the fact that the excitation energy is supplied over a very short period of time (relative to the natural periods of modes of vibration being excited) and the response decays quickly as well, within a second or two. However, to obtain sufficient frequency resolution of the measured FRFs, signal processing constraints often require data acquisition times of 10 s or more. This means that a large part of the response signal is made of the floor response due to unmeasured extraneous excitation. This, in turn, leads to poor signal-to-noise ratios which, in turn, results in FRFs which are ‘spiky’ leading to errors in the curve-fitting. Sometimes the FRFs from impact tests on floors are so noisy that curve-fitting algorithms simply cannot be made to work.



Figure C.2 *Typical instrumented hammer setup using a dual-channel signal analyser*

Shaker testing

The problem of poor signal-to-noise ratios in the instrumented impact testing can be resolved by employing an instrumented shaker excitation. Figure C.3 shows a typical setup of a single-shaker with three accelerometers simultaneously measuring floor responses due to its excitation at a number of different locations.



(a)



(b)

Figure C.3 *Typical single shaker setup for testing (a) a bedroom floor and (b) a hospital floor.*

The excitation is generated by a moving shaker armature of known mass. This mass is driven by a signal generated by a spectrum analyser that is also used to acquire all of the force and response data. A typical PC-based data acquisition setup is shown in Figure C.4.



Figure C.4 *Typical PC-based data acquisition setup.*

If shaker excitation at a single point is used, as shown in Figure C.3, a number of excitation signals (i.e. shaker forces) can be used. Examples of these are stepped-sine, chirp, burst random or continuous random excitation. In all these cases the excitation is prolonged occupying a substantial part of the data acquisition window which gives an improved signal to noise ratio, compared with the instrumented impact testing.

A considerable enhancement of the shaker excitation at a single point of the floor is achieved by multiple uncorrelated random shaker excitation applied simultaneously over a number of test points distributed over the floor area. This enables a better distribution of vibration excitation energy over the floor area, which is the key problem when testing large-scale civil engineering structures. It also speeds up the testing and aids quality assurance during testing. Figure C.5 shows a typical deployment of a state-of-the-art multi-shaker floor excitation system developed at the University of Sheffield (<http://vibration.shef.ac.uk/multishakers>) when testing a floor using a test grid shown in Figure C.1.

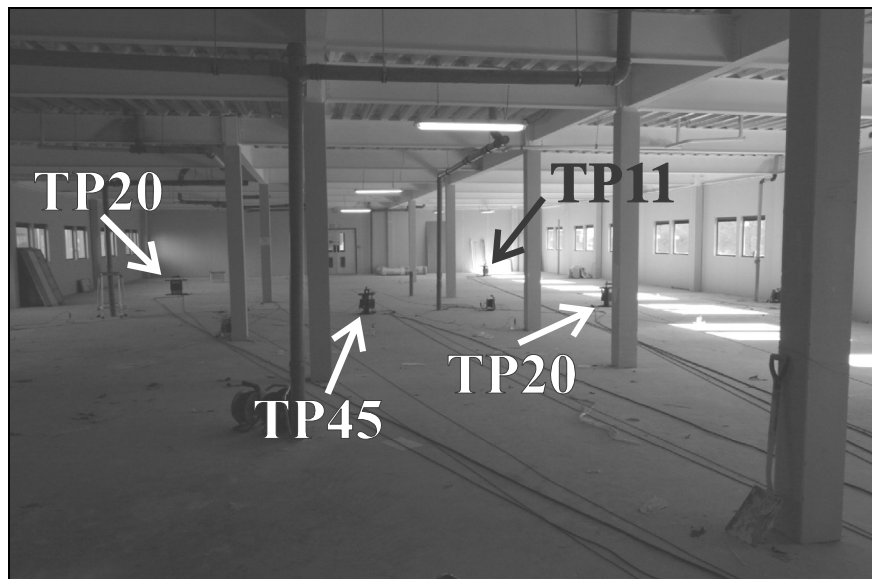
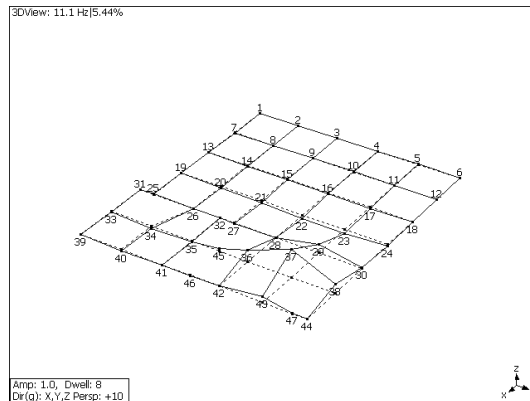

Figure C.5 *Multi-shaker modal testing setup.*

C.2.2 FRF data analysis

Almost invariably, field dynamic testing of floors which are under construction or in operation are carried out under severe time constraints. Noisy field conditions, poor signal-to-noise ratios and possible errors in connecting and running the instrumentation mean that it is quite possible to acquire FRF data of dubious quality. Often, after completion of testing, the data may be unusable. Therefore, it is of utmost importance to analyse the acquired FRF data *in situ* while testing and rectify possible problems on the spot. A competent and fast field operation of a portable PC-based curve-fitting software which animates experimental mode shapes (Figure C.6) is recommended. Typical problems in curve fitting FRFs are: wrongly set channel gains, wrongly connected channels and positioned accelerometers, as well as faulty connectors, cables and accelerometers. After completion of testing and return to base, dealing with this type of error in the FRF data is very difficult and often impossible. Apart from checking the consistency of the FRF data, animated experimental mode-shapes are very useful to appreciate structural behaviour and correlate the measurements with the FE modelling, which is often one of the aims of modal testing. Therefore, a selection of curve-fitting software which can produce animated mode shapes quickly is highly desirable.



Mode 1: $f_1 = 11.1\text{Hz}$; $\zeta_1 = 5.4\%$

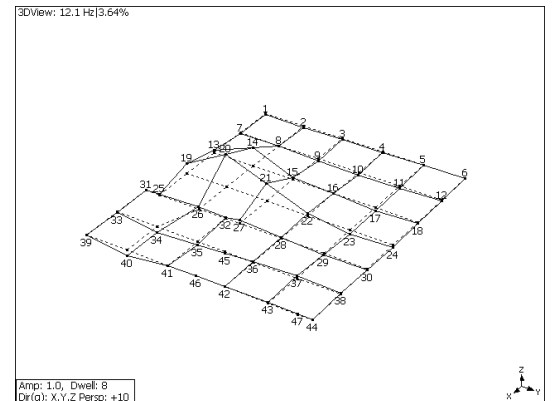

Mode 2: $f_2 = 12.1\text{Hz}$; $\zeta_2 = 3.6\%$

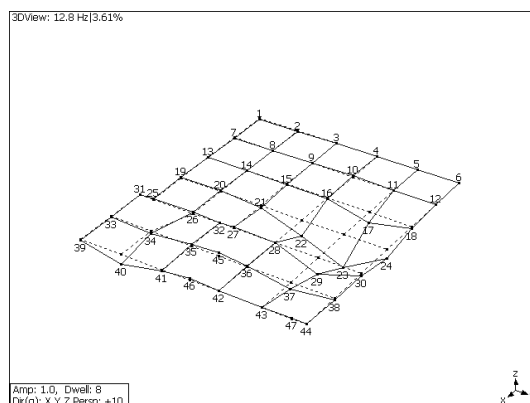

Mode 3: $f_3 = 12.8\text{Hz}$; $\zeta_3 = 3.6\%$

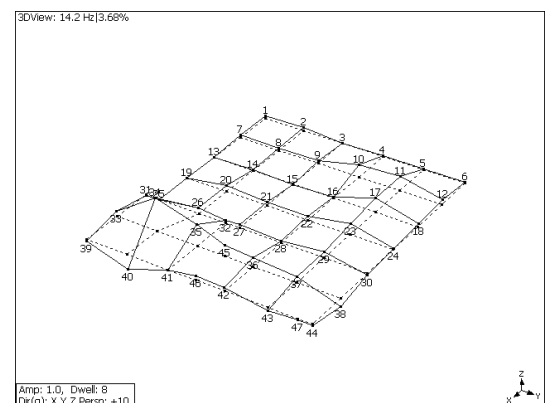

Mode 4: $f_4 = 14.2\text{Hz}$; $\zeta_4 = 3.7\%$

Figure C.6 Floor mode shapes obtained *in situ* from multi-shaker modal testing of a floor shown in Figure C.1.

Another FRF quality check which is useful to perform *in situ* makes use of the reciprocity principle^[50]. This check is performed by plotting two FRFs: one corresponding to the excitation at test point A and response at test point B, and the other corresponding to the excitation at test point B and response as test point A. In theory, for an ideal linear structure in noiseless environment, these two should be identical, due to Maxwell's reciprocity theorem.

Finally, the last aim of modal testing is to obtain modal properties of the floor structure so that adequate pacing rates can be selected in the vibration performance tests, as described in C.3.

C.3 Vibration performance assessment

Although a floor's modal properties are very important, its vibration performance depends most directly on the actual vibration response due to given dynamic excitation. Therefore, as previously mentioned, it is necessary to create relevant dynamic excitation; then after measuring and post-processing floor vibration responses due to it, rate the obtained response parameter.

Response measurement

Depending on the utilisation of the floor, various design scenarios may exist for which its vibration serviceability needs to be checked. A definition of this scenario should be a part of the design specification, so that it is clear what the floor structure should satisfy. This scenario should be recreated as realistically as possible when measuring and judging floor responses.

Typically, for office floors, it is considered that floor responses due to a single person walking should be measured. This is because this kind of excitation happens frequently in floors and is difficult to isolate. Therefore, focus is given to this type of excitation.

After the *in situ* determination of natural frequencies and mode shapes of the floor, as described in Section C.1, the floor can be classified as a low- or high-frequency. This classification leads to a decision as to the type of walking test which needs to be carried out.

In the case of the low-frequency floor and if it is necessary to generate a worst case scenario, then a walking test could be helped by a metronome. As low-frequency floors can be excited in near-resonance by frequencies of one or more harmonics of walking, the metronome is used to help maintain the pacing rate of the test subject and this will help generate such higher harmonics. For example, if a resonance at 6 Hz of a floor needs to be excited, the pacing could be set to two steps per second (2 Hz), so that its third harmonic excites the 6 Hz mode. Also, the fourth harmonic of walking at 1.5 Hz will also excite near resonance at 6 Hz. However, a test whereby walking would be set to 3 Hz so that the second harmonic excites the 6 Hz resonance is usually not carried out simply because walking at 3 Hz is too fast and is more jogging than walking. Floors which are optimised to perform well under walking should not be expected to perform as well under jogging, running or rhythmic activities by one or several synchronised people. Also, people making, say, more than two steps per second (2 Hz) may be considered as an unlikely scenario for an office floor, so a design decision may be that pacing rates above 2 Hz are not relevant. As outlined in Section C.4, to avoid disappointment and unfulfilled expectations, all these decisions should be made before the testing and should be

a part of floor design specification negotiated between and agreed by the relevant parties.

After determining pacing rates relevant for a low-frequency floor, a walking path is selected. This, again, depends on the utilisation of the floor and should be part of the design specification. For example, there may be cases when walking paths only along planned corridors are considered as relevant. Finally, in the case of single person walking, a test subject is selected and asked to walk several times along the walking path, during which responses are measured at a number of pre-selected points on the floor. These may be at a position of maximum amplitudes of mode shapes corresponding to the modes being excited in resonance, or at sensitive locations (e.g. in operating theatres in hospitals). As a consequence of this, the walking path may vary depending upon which mode of vibration the walking test is attempting to excite or, say, how many relevant corridors need checking.

It should be stressed here that human induced dynamic forces due to walking, running, jumping, etc. are in essence narrow-band random processes^[55]. However, these are often modelled mathematically as periodic forces. Notwithstanding this, it is advantageous for the same test subject to repeat nominally the same test at least twice and also to include more than one human test subject in the testing, if possible. This will produce a more realistic range of responses that can be judged.

In the case of high-frequency floors, the response measurement process is similar. The only difference is that the pacing rates do not need to be adjusted so that their higher harmonics excite floor resonances. This is because in the high frequency floors, resonant build up does not happen and the response is a series of rapidly decaying responses following each heel hit. Usually, in this case, a range of pacing frequencies is specified (say, five pacing rates from 1.4 Hz to 2.2 Hz at steps of 0.2 Hz). As before, each test subject should repeat nominally identical tests at least twice and more than one test subject should be used, if possible. Figure C.7 and Figure C.8 show measured responses due to walking on a low- and high-frequency floor, respectively.

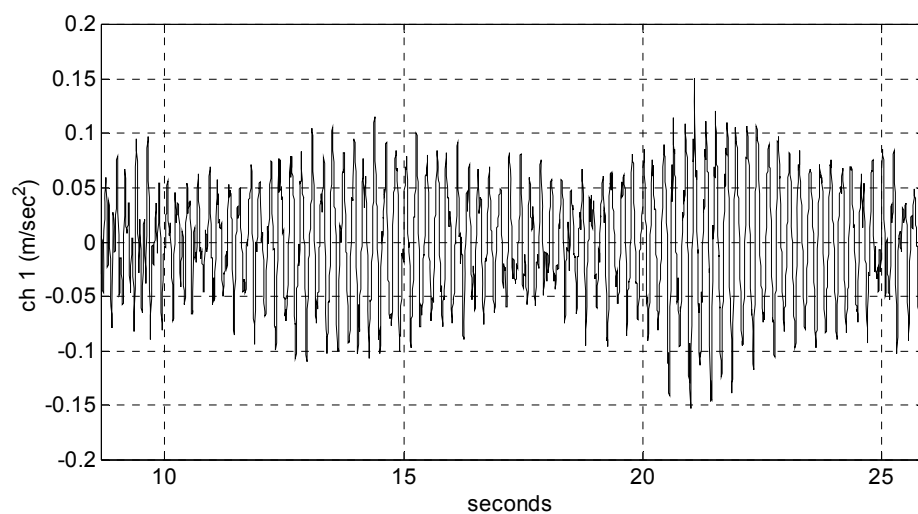

Figure C.7 *Response of a low-frequency floor having natural frequency of 4.6 Hz subject to walking at 2.3 Hz. A resonant build up is clearly observable.*

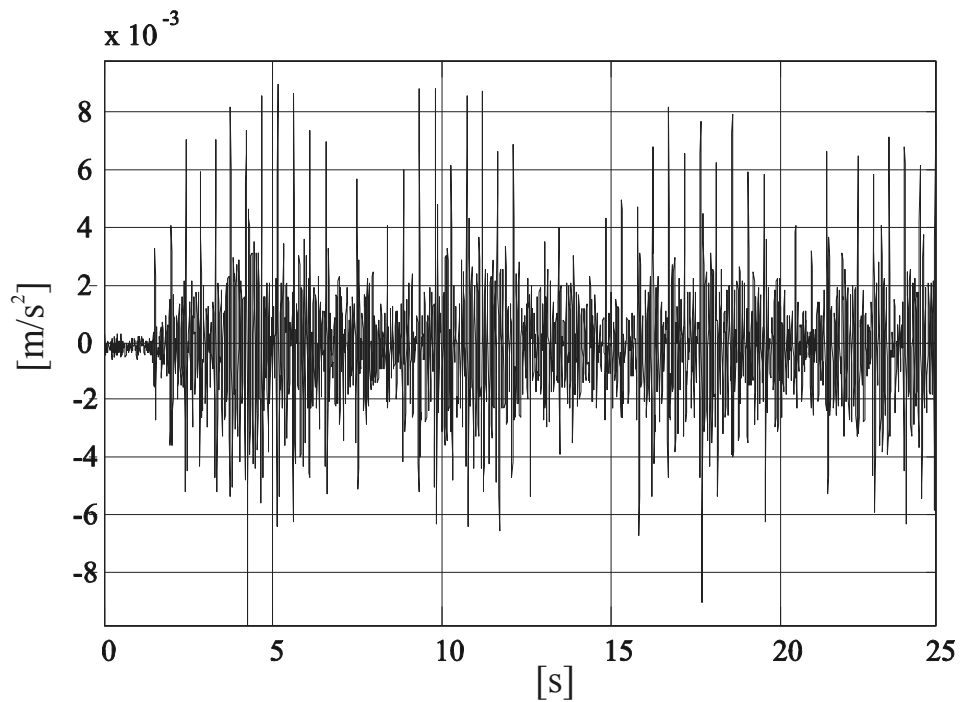

Figure C.8 *Response of a high-frequency floor, having natural frequency of 12.6 Hz, subject to walking at 2.1 Hz. A series of peaks followed by decaying responses is clearly observable. No resonant buildup is observable.*

In addition to these short tests, requiring an unoccupied building, technology now exists whereby a long-term monitoring of floor vibration can be performed. One or more vibration transducers can be installed on the floor in an unintrusive manner and left to acquire vibration response data due to everyday normal floor usage by its occupants over a prolonged period of time. This could be a whole day, several days, or longer. Figure C.9 shows an unintrusive installation of a transducer underneath a false floor. The data acquisition system used in this system to facilitate the measurements is controlled remotely via a wireless or internet connection.



Figure C.9 *Unintrusive installation of a vibration transducer underneath a false floor for long term monitoring.*

Response post-processing and rating

Vibration response post-processing and rating depends on the receiver selected. Typically, receivers are either humans or vibration sensitive processes. Handling of the latter is a specialist area which has been described in detail by Brownjohn and Pavic^[56] and will not be repeated here. However, post-processing and rating of measured vibration responses when humans are vibration receivers is more frequently required.

As human sensitivity to vibrations is frequency dependent, the method of frequency weighting^[28] is nowadays employed to account for this. This is usually performed digitally using specialist software and processing of digitised signals measured on the floor. The weighting leaves vibration levels unchanged where the contour is low (say, between 4 and 8 Hz) and attenuates the levels at frequencies to which humans are more ‘resistant’. In this way, vibration response is ‘normalised’ to the same sensation level no matter what the excitation frequency is.

Such weighted (typically acceleration) time-histories can then be used to determine a single value (or parameter) which characterises the vibration. There are two parameters which are typically used in modern codes of practice, such as BS 6472^[3] or ISO 10137^[2], for assessing the amount of vibration and its effects. These are the rms acceleration, and the recently established vibration dose value (VDV).

Vibrations in buildings are seldom simple sinusoids. Often, the vibration time signatures are modulated, transient or random, and they contain a range of frequencies. After being weighted, the most common method for mapping such vibrations into a single numerical (‘response’) value to be compared with the vibration limit is to calculate the rms of the weighted acceleration time-history $a_w(t)$ using the following formula:

$$\text{RMS acceleration} = \left[\frac{\int_{t_1}^{t_2} a_w^2(t) dt}{t_2 - t_1} \right]^{1/2} = \left[\frac{\int_{t_1}^{t_2} a_w^2(t) dt}{T} \right]^{1/2}$$

Where $T = t_2 - t_1$ is the rms averaging time. An rms acceleration is used as it is a measure of the total vibration causing distress to the human body. Greater rms accelerations correspond to higher vibration magnitudes causing more annoyance. However, an assessment of the human distress using the rms relationship is appropriate for, as Griffin^[28] defines them, “well behaved” vibrations which are steady-state long-lasting periodic or stationary random. If the vibrations are short lived transients, then the rms acceleration is no longer a reliable effective value.

A method that addresses this problem and is gaining acceptance internationally, is the previously mentioned vibration dose value (VDV) method. The VDV is a cumulative measure of the vibration transmitted to a human receiver during a certain period of interest $T = t_2 - t_1$, and is calculated as:

$$\text{VDV} = \left[\int_{t_1}^{t_2} a_w^2(t) dt \right]^{1/4}$$

Calculation of the rms acceleration from test results is strongly affected by the length of the selected time period. Values ranging from less than 1 s to 60 s could be found in the literature. In the UK, there is little information contained within the current codes of practice on a standard period that should be considered when calculating the rms acceleration. As a consequence of this, researchers have often considered the ‘significant’ portion of the acceleration-time history from walking tests, which has caused the results of such tests to vary widely. A study in Sweden^[57] suggested that a period of 10 s is appropriate. However, this may be impractical for small floor areas, where only a few paces may physically be undertaken. In this case 1s rms averaging time may be appropriate. Reporting both 1 s and 10 s rms of weighted floor accelerations is usual. This is suggested in order for the wider engineering community to obtain some sort of ‘common denominator’ describing floor vibration performance always in the same way. Such a commonly used parameter does not currently exist in the research literature on floor vibration, due to the lack of a general strategy when conducting measurements and reporting measurement data, making the interpretation of the past investigations difficult if not impossible.

C.4 Management issues

Modal testing and vibration performance assessment based on experimental data are powerful tools which can be used to ascertain the as-built vibration behaviour of building floors. This is particularly so considering the considerable complexities and uncertainties in the floor vibration behaviour which exist when designing them. Current state-of-the-art regarding vibration serviceability design of building floors of whatever type is such that it is prudent to test them after they are constructed to check the actual performance of the end product and verify how close they are to the design.

However, this experimental tool is still not widely used in the civil engineering community in the UK and worldwide for a number of reasons. These include: (1) various liability issues if/when something negative is found during testing, (2) lack of awareness of the available technology, (3) lack of planning and detailed design specifications requiring experimental checking and (4) cost of testing.

Clients and their representatives are increasingly commissioning floor testing services; in particular, when floor vibration performance is critical for day-to-day operation of a floor, such as in hospitals. Indeed, dynamic testing of grandstands is now commonly carried out in the UK to ascertain their dynamic performance against crowd dynamic loading. Floor dynamic testing provides clients with hard evidence as to the actual performance of the building product they paid for, which is often very expensive, in particular if remedial measures are required after construction. On the other hand, consultants/contractors obtain invaluable data on the real-life behaviour of their structure which enhances their confidence and can be used in future designs of similar structures. The increased liability and testing cost issue should be possible to mitigate through careful design specification and forward planning of financial expenditure, in particular in the tendering stage. Both of these are currently

often neglected when floor vibration serviceability is in question. For example, design specifications stating that the floor should have satisfactory vibration performance without specifying the exact conditions which have to be satisfied, are too broad and should not be accepted. As they are ill defined, such specifications are often perceived as unimportant and given low priority in design.

APPENDIX D WORKED EXAMPLES

	Page No
D.1 Vibration response of a composite floor	98
D.2 Vibration response of a lightweight floor	106
D.3 Design for rhythmic activity	112



Silwood Park, Ascot, Berks SL5 7QN
 Telephone: + 44 (0) 1344) 636525
 Fax: + 44 (0) 1344) 636570

CALCULATION SHEET

Job No.	BCB 144	Sheet	1 of 8	Rev
Job Title	P354 Design of Floors for Vibration: A New Approach			
Subject	Example No.1 – Vibration response of a composite floor			
Client	Made by	ALS	Date	March 2007
	Checked by	LPN	Date	April 2007

D.1 Vibration response of a composite floor

This example demonstrates the calculation of floor response for a composite floor in an office environment. The floor consists of a 130 mm deep normal weight slab supported by 6.0 m span secondary beams at 2.48 m cross-centres which, in turn, are supported by 7.45 m span castellated primary beams. The floor is fully fitted out with full height partitions in place, and is Floor O4 (SCI Headquarters) in Table A.1 of Appendix A

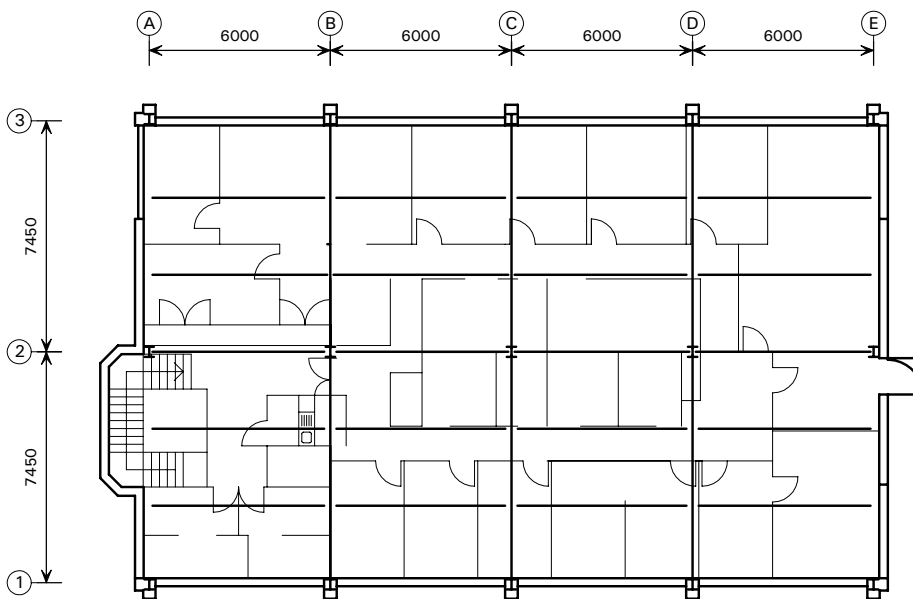

Floor and beam data

Floor structure

130 mm deep normal weight concrete slab cast on top of 1.2 mm thick re-entrant deck. Slabs supported by 6.0 m span secondary beams at 2.48 m cross-centres which, in turn, are supported by 7.45 m span castellated primary beams in the orthogonal direction on Grid-lines B to D.

Main beam sizes:

Primary beams: 686 × 152 Castellated UB 60

Secondary beams: 305 × 127 UB 42

Floor loading

130 mm deep concrete slab	= 2.79 kN/m ²
Decking	= 0.17 kN/m ²
Ceiling and services	= 0.50 kN/m ²
Raised floor	= 0.30 kN/m ²
Ducting	= 0.10 kN/m ²
10% Imposed	= 0.35 kN/m ²
	<u>4.21 kN/m²</u>



Silwood Park, Ascot, Berks SL5 7QN
 Telephone: + 44 (0) 1344) 636525
 Fax: + 44 (0) 1344) 636570

CALCULATION SHEET

Job No.	BCB 144	Sheet	2 of 8	Rev
Job Title	P354 Design of Floors for Vibration: A New Approach			
Subject	Example No.1 – Vibration response of a composite floor			
Client	Made by	ALS	Date	March 2007
	Checked by	LPN	Date	April 2007

Beams self-weight:

Primary beams $59.8 \times 9.81/6 \times 10^{-3} = 0.10 \text{ kN/m}^2$
 Secondary beams $41.9 \times 9.81/2.48 \times 10^{-3} = 0.17 \text{ kN/m}^2$
 Total $= 0.27 \text{ kN/m}^2$

Total distributed mass for floor, $m = (4.21 + 0.27) \times 10^3/9.81 = 456.68 \text{ kg/m}^2$

D.1.1 Composite slab properties

Data from decking manufacturer:

Decking neutral axis position	17.28 mm
Decking area/unit width	2124 mm ² /m
Decking second moment of area	863500 mm ⁴ /m
Height of re-entrant ribs	51 mm

Concrete area/unit width for 130 mm deep slab = 0.121 m²/m

∴ Effective slab thickness = 121 mm

Height of concrete above deck = 130 – 51 = 79 mm (7.9 cm)

For dynamic behaviour, take gross uncracked inertia. Also, for normal weight concrete, take $E_c = 38 \text{ kN/mm}^2$

∴ Modular ratio $\alpha = 205 / 38 = 5.39$

Position of elastic neutral axis:

Section	Steel area cm ² /m	y cm	Area × y cm ³ /m
Concrete	$1210/\alpha = 224.49$	6.05	1358.16
Decking	21.24	11.27	239.37
	<u>245.73</u>		<u>1597.53</u>

∴ Position of composite slab ENA = $1597.53 / 245.73$
 = 6.50 cm below top of slab

Second moment of area:

Section	Distance from ENA cm	Area × Distance ² cm ⁴	I Local cm ⁴
Concrete	0.45	45.46	2738.96
Decking	4.77	483.27	86.35
		<u>528.73</u>	<u>2825.31</u>

∴ Second moment of area of composite slab:
 = $528.73 + 2825.31 = 3354.04 \text{ cm}^4/\text{m}$ ($33.54 \times 10^{-6} \text{ m}^4/\text{m}$)



Silwood Park, Ascot, Berks SL5 7QN
 Telephone: + 44 (0) 1344) 636525
 Fax: + 44 (0) 1344) 636570

CALCULATION SHEET

Job No.	BCB 144	Sheet	3 of 8	Rev
Job Title	P354 Design of Floors for Vibration: A New Approach			
Subject	Example No.1 – Vibration response of a composite floor			
Client	Made by	ALS	Date	March 2007
	Checked by	LPN	Date	April 2007

D.1.2 Composite beam properties

Secondary beam

Serial size: 305 × 127 UB 42

Span: 6.00 m (typical)	Mass:	41.9 kg/m
Depth: 307.2 mm	Average spacing:	2.48 m
I_{beam} : 8196 cm ⁴	Area, A:	53.4 cm ²

Span / 4 = 6000 / 4 = 1500 mm (< spacing 2480 mm)

∴ Effective breadth = 1500 mm

Composite section properties:

	Width (cm)	Depth (cm)	y (cm)		A (cm ²)	Ay (cm ³)	Ay ² (cm ⁴)	I_{local} (cm ⁴)
Slab	150	7.90 [†]	3.95	1185/5.39=	219.85	868.41	3430	1143
Beam			28.36		53.40	1514.42	42949	8196
					<u>273.25</u>	<u>2382.83</u>	<u>46379</u>	<u>9339</u>

([†] For slab spanning perpendicular to beam, ignore the concrete in the troughs for slab stiffness)

Position of elastic neutral axis = 2382.83 / 273.25 = 8.72 cm below top of slab

Gross second moment of area = 46379 + 9339 – 8.72² × 273.25
 = 34941 cm⁴ (3.49 × 10⁻⁴ m⁴)

Primary beam

Serial size: 686 × 152 Castellated UB 60

Span: 7.45 m (typical)	Mass:	59.8 kg/m
Depth: 683.1 mm	Average spacing:	6.0 m
I_{beam} : 59230 cm ⁴	Area, A:	57.7 cm ²

Span / 4 = 7450 / 4 = 1862 mm (< spacing 6000 mm)

∴ Effective breadth = 1862 mm

Composite section properties:

	Width (cm)	Depth (cm)	y (cm)		A (cm ²)	Ay (cm ³)	Ay ² (cm ⁴)	I_{local} (cm ⁴)
Slab	186.20	12.10	6.05	2253/5.39=	418.00	2528.90	15300	5100
Beam			47.16		57.70	2721.13	128328	59230
					<u>475.70</u>	<u>5250.03</u>	<u>143628</u>	<u>64330</u>

Position of elastic neutral axis = 5250.03 / 475.70 = 11.04 cm below top of slab

Gross second moment of area = 143628 + 64330 – 11.04² × 475.70
 = 149979 cm⁴ (15.00 × 10⁻⁴ m⁴)



Silwood Park, Ascot, Berks SL5 7QN
 Telephone: + 44 (0) 1344) 636525
 Fax: + 44 (0) 1344) 636570

CALCULATION SHEET

Job No.	BCB 144	Sheet	4 of 8	Rev
Job Title	P354 Design of Floors for Vibration: A New Approach			
Subject	Example No.1 – Vibration response of a composite floor			
Client	Made by	ALS	Date	March 2007
	Checked by	LPN	Date	April 2007

D.1.3 Mode shapes and beam boundary conditions

The fundamental mode is that which gives the lowest natural frequency (i.e. the highest deflection)

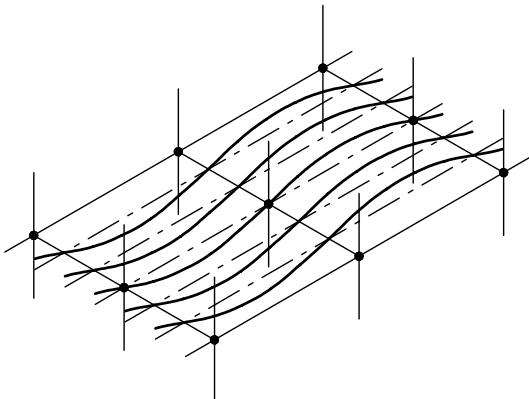

Mode A Secondary beam mode

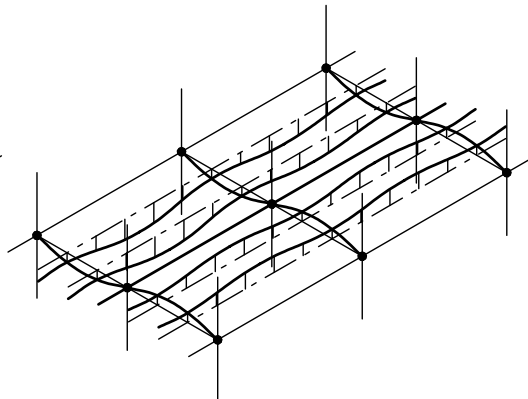

Mode B Primary beam mode

For mode A, the primary beams form nodal lines (i.e. they have zero deflection) about which the secondary beams vibrate as simply-supported members. In this case, the slab flexibility is affected by the approximately equal deflections of the supports (i.e. the secondary beams). As a result of this, the slab frequency is assessed on the basis that fixed-ended boundary conditions exist.

For mode B, the primary beams vibrate about the columns as simply-supported members. Using a similar reasoning as above, due to the equal deflections at their supports, the secondary beams (as well as the slab) are assessed on the basis that fixed-ended boundary conditions exist.

D.1.4 Fundamental natural frequency

Mode A

i) Slab (fixed-ended)

$$w = 4.21 \times 2.48 = 10.44 \text{ kN per m width}$$

$$\delta_s = \frac{wL^3}{384EI} = \frac{10.44 \times 2.48^3}{384 \times 205 \times 10^6 \times 33.54 \times 10^{-6}} \times 10^3 = 0.06 \text{ mm}$$

ii) Secondary beam (simply-supported)

$$w_s = 6 \times (10.44 + 41.9 \times 9.81/10^3) = 65.11 \text{ kN}$$

$$\delta_{sec} = \frac{5w_s L^3}{384EI} = \frac{5 \times 65.11 \times 6.0^3}{384 \times 205 \times 10^6 \times 3.49 \times 10^{-4}} \times 10^3 = 2.56 \text{ mm}$$

$$\text{Total deflection} = 0.06 + 2.56 = 2.62 \text{ mm}$$

$$\therefore \text{Natural frequency for Mode A, } f_A = \frac{18}{\sqrt{\delta}} = \frac{18}{\sqrt{2.62}} = 11.12 \text{ Hz}$$

Equation (4)



Silwood Park, Ascot, Berks SL5 7QN
 Telephone: + 44 (0) 1344) 636525
 Fax: + 44 (0) 1344) 636570

CALCULATION SHEET

Job No.	BCB 144	Sheet	5 of 8	Rev
Job Title	P354 Design of Floors for Vibration: A New Approach			
Subject	Example No.1 – Vibration response of a composite floor			
Client	Made by	ALS	Date	March 2007
	Checked by	LPN	Date	April 2007

Mode B

i) Slab

As above

ii) Secondary beam (fixed-ended)

$$\delta_{\text{sec}} = \frac{w_s L^3}{384EI} = \frac{2.56}{5} = 0.51 \text{ mm}$$

iii) Primary beams (simple-supports)

$$P = \frac{2 \times w_s}{2} = 65.11 \text{ kN}$$

$$w_p = 7.45 \times (59.8 \times 9.81/10^3) = 4.37 \text{ kN}$$

$$\delta_p = \frac{23PL^3}{648EI} + \frac{5w_p L^3}{384EI} = \frac{7.45^3}{205 \times 10^6 \times 15.00 \times 10^{-4}} \left(\frac{23 \times 65.11}{648} + \frac{5 \times 4.37}{384} \right) \times 10^3$$

$$= 3.18 \text{ mm}$$

Total deflection = 0.06 + 0.51 + 3.18 = 3.75 mm

$$\therefore \text{Natural frequency for Mode B, } f_B = \frac{18}{\sqrt{\delta}} = \frac{18}{\sqrt{3.75}} = 9.30 \text{ Hz}$$

\therefore Mode B governs and, hence, the fundamental frequency of the floor $f_0 = 9.30 \text{ Hz}$

Equation (4)

D.1.5 Modal mass

$$L_{\text{eff}} = 1.09(1.10)^{n_y-1} \left(\frac{EI_b}{mbf_0^2} \right)^{1/4} = 1.09(1.10)^{(4-1)} \left(\frac{205 \times 10^9 \times 3.49 \times 10^{-4}}{456.68 \times 2.48 \times 9.30^2} \right)^{1/4}$$

$$= 7.54 \text{ m} \leq n_y L_y = 24 \text{ m}$$

Equation (45)

$$S = \eta(1.15)^{n_x-1} \left(\frac{EI_s}{mf_0^2} \right)^{1/4} = 0.71 \times (1.15)^{(2-1)} \left(\frac{205 \times 10^9 \times 33.54 \times 10^{-6}}{456.68 \times 9.30^2} \right)^{1/4}$$

$$= 2.97 \text{ m} \leq n_x L_x = 14.9 \text{ m}$$

Equation (46)

Note $\eta = 0.71$ from Table 7.3

$$M = m L_{\text{eff}} S = 456.68 \times 7.54 \times 2.97 = 10226.80 \text{ kg}$$

Equation (44)



Silwood Park, Ascot, Berks SL5 7QN
 Telephone: + 44 (0) 1344) 636525
 Fax: + 44 (0) 1344) 636570

CALCULATION SHEET

Job No.	BCB 144	Sheet	6 of 8	Rev
Job Title	P354 Design of Floors for Vibration: A New Approach			
Subject	Example No.1 – Vibration response of a composite floor			
Client	Made by	ALS	Date	March 2007
	Checked by	LPN	Date	April 2007

D.1.6 Floor response

As $f_0 < 10.0$ Hz, the response is to be assessed according to the ‘low frequency floor’ recommendations

$$a_{w,rms} = \mu_e \mu_r \frac{0.1Q}{2\sqrt{2M}\zeta} W\rho$$

Equation (50)

$Q = 746$ N based on an average weight of 76 kg

From tests, the critical damping ratio, $\zeta = 4.68\%$

Table A.1

Since $f_0 > 8$ Hz, for z-axis vibrations the weighting factor,
 $W = 8 / f_0 = 8 / 9.30 = 0.86$

Equation (21)

Note – W_g weighting factor used here to enable comparison with test results

Conservatively assume that $\mu_e = \mu_r = 1$

Maximum corridor length of 15 m, assume walking at 2 Hz (average walking frequency)

$$v = 1.67f_p^2 - 4.83f_p + 4.50 = 1.67 \times 2.0^2 - 4.83 \times 2.0 + 4.50 = 1.52 \text{ m/s}$$

Equation (16)

$$\rho = 1 - e^{\left(\frac{-2\pi\zeta L_p f_p}{v}\right)} = 1 - e^{\left(\frac{-2\pi \times 0.0468 \times 15 \times 2}{1.52}\right)} = 1.0$$

Equation (37)

$$a_{w,rms} = 1 \times 1 \frac{0.1 \times 746}{2\sqrt{2} \times 10226.80 \times 4.68\%} \times 0.86 \times 1.0 = 47.39 \times 10^{-3} \text{ m/s}^2$$

Response factor

$$R = \frac{a_{w,rms}}{0.005} = \frac{47.39 \times 10^{-3}}{0.005} = 9.48$$

Equation (38)

Comparing with the limiting values in Table 5.2 and Table 5.3, the floor is unacceptable for continuous vibrations. The effect of intermittent vibrations should now be considered.



Silwood Park, Ascot, Berks SL5 7QN
 Telephone: + 44 (0) 1344) 636525
 Fax: + 44 (0) 1344) 636570

CALCULATION SHEET

Job No.	BCB 144	Sheet	7 of 8	Rev
Job Title	P354 Design of Floors for Vibration: A New Approach			
Subject	Example No.1 – Vibration response of a composite floor			
Client	Made by	ALS	Date	March 2007
	Checked by	LPN	Date	April 2007

Vibration dose value

$$T_a = \frac{L_p}{v} = \frac{15}{1.52} = 9.87 \text{ s}$$

$$n_a = \frac{1}{T_a} \left[\frac{VDV}{0.68 \times a_{w,rms}} \right]^4$$

Equation (41)

From Table 5.4, $VDV = 0.2$ to 0.4 for buildings during a 16 hr day for low probability of adverse comment. For $VDV = 0.4$,

$$n_a = \frac{1}{9.87} \left[\frac{0.4}{0.68 \times 47.39 \times 10^{-3}} \right]^4 = 2405$$

Therefore, the floor can be traversed up to 2,405 times in a 16 hr day (i.e. 150 times per hr) for ‘a low probability of adverse comment’. As this level of activity is unlikely to occur in a quiet office such as this, the floor can be classed as acceptable.

D.1.7 Finite element analysis

The first three mode shapes from the finite element analysis of the floor are shown here:

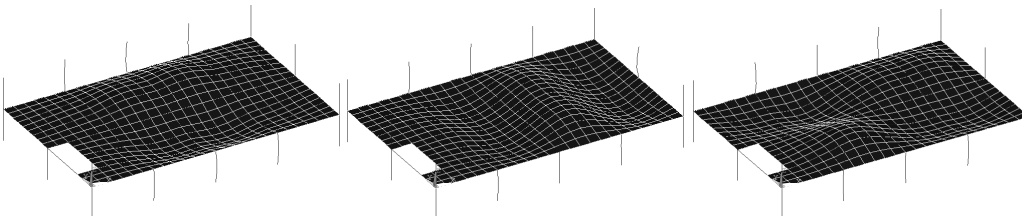

The analysis predicted a fundamental natural frequency of 10.80 Hz, which, as shown above, is a primary beam mode. The frequency of the second (secondary beam) mode is predicted as 11.73 Hz. The same predictions from the simplified method were 9.31 Hz and 11.14 Hz. It is likely that the difference between the sets of frequencies is due to the staircase located in the bottom left bay of the structure.

The response analysis using the FE output calculated a maximum response factor, $R = 3.18$ in the range 1.8 Hz to 2.2 Hz, which is clearly much lower than that predicted by the simplified method. However, it should be expected that the FE approach will be more accurate than the simplified approach due to the simplifying assumptions. A plot of response factor against pacing frequency is shown in the figure below:



Silwood Park, Ascot, Berks SL5 7QN
 Telephone: + 44 (0) 1344) 636525
 Fax: + 44 (0) 1344) 636570

CALCULATION SHEET

Job No.	BCB 144	Sheet	8 of 8	Rev
Job Title	P354 Design of Floors for Vibration: A New Approach			
Subject	Example No.1 – Vibration response of a composite floor			
Client	Made by	ALS	Date	March 2007
	Checked by	LPN	Date	April 2007

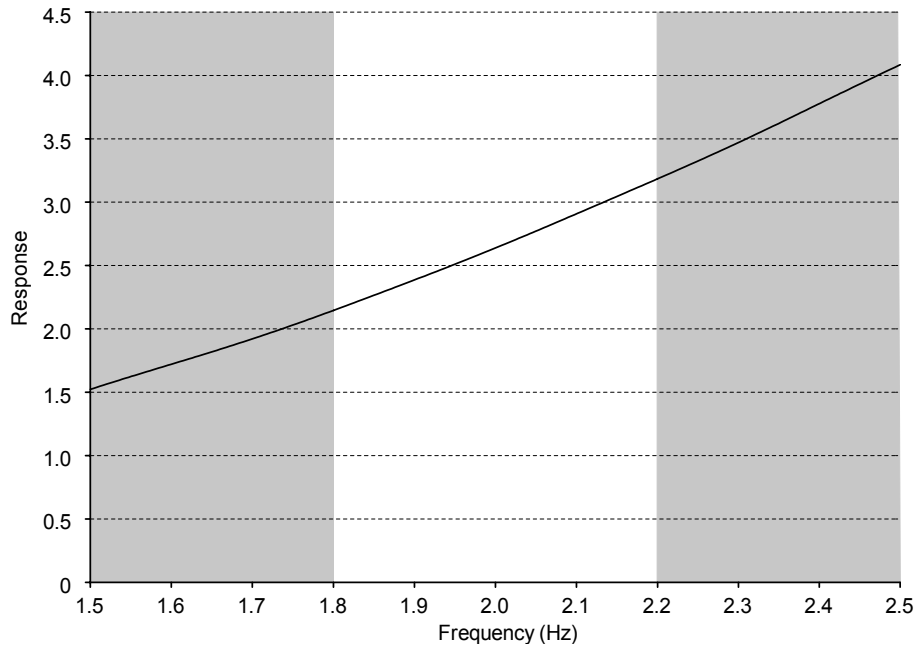

D.1.8 Test results

Instrumented hammer and shaker testing found that the lowest frequencies of the floor were 8.4 Hz and 9.6 Hz. These frequencies are lower than those predicted, and this difference could be due to a discrepancy in the mass present in service and the mass used in the calculation.

Walking tests gave a maximum response factor, $R = 3.85$, at a pace frequency of 3 Hz. This frequency is difficult to obtain and will very rarely occur. The response at a more realistic frequency of 2 Hz was found to be $R = 2.57$, which is lower than that predicted by both methods.



Silwood Park, Ascot, Berks SL5 7QN
 Telephone: + 44 (0) 1344) 636525
 Fax: + 44 (0) 1344) 636570

CALCULATION SHEET

Job No.	BCB 144	Sheet	1 of 6	Rev
Job Title	P354 Design of Floors for Vibration: A New Approach			
Subject	Example No.2 – Vibration response of a lightweight floor			
Client	Made by	ALS	Date	March 2007
	Checked by	LPN	Date	April 2007

D.2 Vibration response of a lightweight floor

This example demonstrates the calculation of floor response for a lightweight floor in a residential environment, consisting of 22 mm deep chipboard flooring supported by 220 mm deep steel channels, spanning 4.875 m at 590 mm spacing. The floor is fully fitted out with full height partitions in place, and is floor L2 in Table A.3 of Appendix A. The example first considers the stiffness method originally presented in P301^[43], which will be suitable in most circumstances, and then considers a response analysis which can be used if required.

D.2.1 Generic residential building with lightweight floors

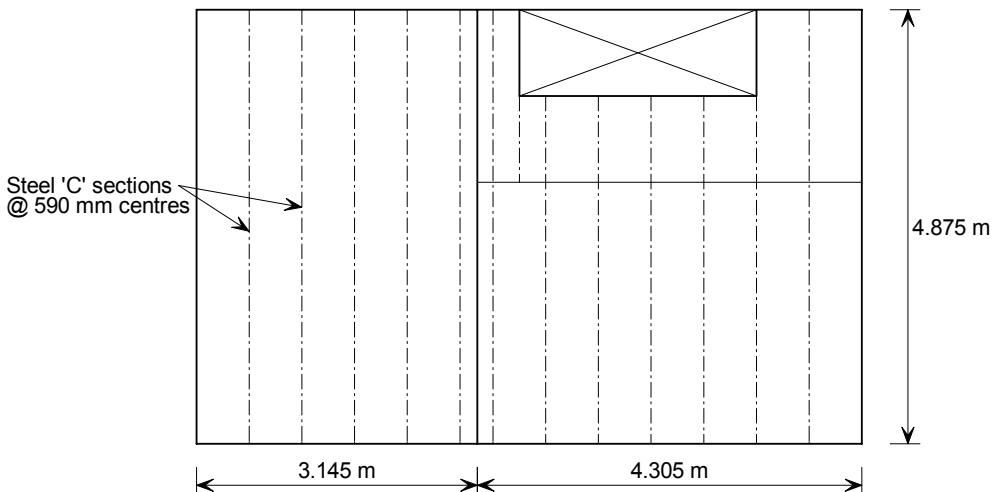

Floor and beam data:

Floor structure:

chipboard flooring on lightweight steel channel sections 4.875 m span @ 590 mm centres

Chipboard:

thickness 22 mm
 density 650 kg/m³
 modulus of elasticity 2.9 kN/mm²

Lightweight steel channel:

depth 220 mm
 flange width 125 mm
 thickness 1.6 mm
 area 7.47 cm²
 I_{xx} 613 cm⁴
 mass 5.86 kg/m



Silwood Park, Ascot, Berks SL5 7QN
 Telephone: + 44 (0) 1344) 636525
 Fax: + 44 (0) 1344) 636570

CALCULATION SHEET

Job No.	BCB 144	Sheet	2 of 6	Rev
Job Title	P354 Design of Floors for Vibration: A New Approach			
Subject	Example No.2 – Vibration response of a lightweight floor			
Client	Made by	ALS	Date	March 2007
	Checked by	LPN	Date	April 2007

Floor Loading

chipboard	=	$650 \times 0.022 \times 9.81 / 10^3$	=	0.14 kN/m ²
channels	=	$5.86 / 0.59 \times 9.81 / 10^3$	=	0.10 kN/m ²
ceiling and services	=		=	0.20 kN/m ²
10% of imposed load	=		=	0.25 kN/m ²
	=		=	<u>0.69 kN/m²</u>

Distributed mass, $m = 0.69 \times 10^3 / 9.81 = 70.34 \text{ kg/m}^2$

Assume steel channel and chipboard act compositely.

Composite Properties

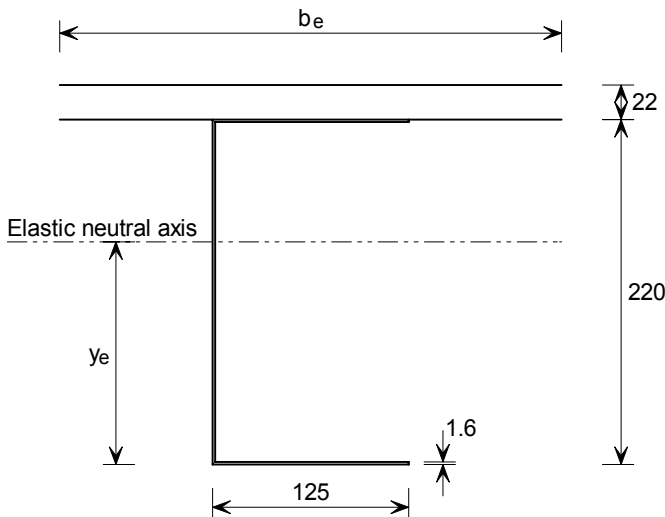

$b_e = \text{span}/4 = 4875/4 = 1219 \text{ mm}$
 but $b_e \leq \text{spacing} = 590 \text{ mm}$
 therefore $b_e = 590 \text{ mm}$

convert b_e to steel units

$\therefore b_e = 590 \times E_{\text{chipboard}}/E_{\text{steel}} = 590 \times 2.9/205 = 8.34 \text{ mm}$

	Width (cm)	Depth (cm)	y (cm)	A (cm ²)	Ay (cm ³)	Ay ² (cm ⁴)	I _{local} (cm ⁴)
Chipboard	0.83	2.20	23.10	1.83	42.27	976.44	0.74
Beam			11.00	7.47	82.17	903.87	613.00
				9.30	124.44	1880.31	613.74

Position of elastic neutral axis = $124.44 / 9.30 = 13.38 \text{ cm}$ from bottom flange

Gross second moment of area = $1880.31 + 613.74 - 13.38^2 \times 9.30$
 = 829.12 cm^4 ($8.29 \times 10^{-6} \text{ m}^4$)
 = $1405.29 \text{ cm}^4/\text{m}$ ($14.05 \times 10^{-6} \text{ m}^4/\text{m}$)



Silwood Park, Ascot, Berks SL5 7QN
 Telephone: + 44 (0) 1344) 636525
 Fax: + 44 (0) 1344) 636570

CALCULATION SHEET

Job No.	BCB 144	Sheet	3 of 6	Rev
Job Title	P354 Design of Floors for Vibration: A New Approach			
Subject	Example No.2 – Vibration response of a lightweight floor			
Client	Made by	ALS	Date	March 2007
	Checked by	LPN	Date	April 2007

D.2.2 Natural frequency

Consider floor panel on left-hand side, span of 4.875 m

$$W = 0.69 \times 4.875 = 3.36 \text{ kN}$$

assume simply supported end condition

$$\delta = \frac{5WL^3}{384EI} = \frac{5 \times 3.36 \times 4.875^3}{384 \times 205 \times 10^6 \times 14.05 \times 10^{-6}} \times 10^3 = 1.76 \text{ mm}$$

$$f_o = \frac{18}{\sqrt{\delta}} = \frac{18}{\sqrt{1.76}} = \underline{\underline{13.6 \text{ Hz}}}$$

Equation (4)

D.2.3 Stiffness approach

$$I_b \geq \frac{L_y^3 \times 10.16}{N_{\text{eff}} \times \delta_j}$$

Equation (56)

From Table 8.3, $N_{\text{eff}} = 2.36$ (by interpolation) for chipboard floor at 590 mm centres.

From Table 8.4, $\delta_j = 1.36$ mm (by interpolation) for a joist span of $L_y = 4.875$ m

$$I_b \geq \frac{4.875^3 \times 10.16}{2.36 \times 1.36} = 366.75 \text{ cm}^4$$

As this is less than the beam inertia obtained above, and the calculated frequency is greater than 8 Hz, the floor can be considered to be acceptable for general residential applications. However, if a response analysis is required, the following procedures can be used:

D.2.4 Modal mass

$$L_{\text{eff}} = n_y \left[0.2L_y^2 - 2.1L_y + 7.5 \right] \times \sqrt{\frac{I_b}{5.3 \times 10^{-6}}}$$

$$= 1 \times \left[0.2 \times 4.875^2 - 2.1 \times 4.875 + 7.5 \right] \times \sqrt{\frac{14.05 \times 10^{-6}}{5.3 \times 10^{-6}}}$$

$$= 3.28 \text{ m} \leq n_y L_y = 4.875 \text{ m}$$

Equation (58)

$$S = 0.75(L_x + 1) \times \sqrt{\frac{I_b}{5.3 \times 10^{-6}}} + 5.9(0.6 - s_j) \leq n_x L_x$$

$$= 0.75 \times (3.145 + 1) \times \sqrt{\frac{14.05 \times 10^{-6}}{5.3 \times 10^{-6}}} + 5.9 \times (0.6 - 0.59)$$

$$= 5.12 \text{ m} \leq n_x L_x = 2 \times 3.145 = 6.29 \text{ m}$$

Equation (59)

$$M = m L_{\text{eff}} S = 70.34 \times 3.28 \times 5.12 = 1181.26 \text{ kg}$$

Equation (44)



Silwood Park, Ascot, Berks SL5 7QN
 Telephone: + 44 (0) 1344) 636525
 Fax: + 44 (0) 1344) 636570

CALCULATION SHEET

Job No.	BCB 144	Sheet	4 of 6	Rev
Job Title	P354 Design of Floors for Vibration: A New Approach			
Subject	Example No.2 – Vibration response of a lightweight floor			
Client	Made by	ALS	Date	March 2007
	Checked by	LPN	Date	April 2007

D.2.5 Floor response

$$a_{w,rms} = 2\pi \mu_e \mu_r \frac{185}{Mf_0^{0.3}} \frac{Q}{700} \frac{1}{\sqrt{2}} W$$

Equation (60)

Q = 746 N based on an average weight of 76 kg

Since $f_0 > 8$ Hz, for z-axis vibrations the weighting factor,
 $W = 8 / f_0 = 8 / 13.6 = 0.59$

Equation (21)

Note – W_g weighting factor used here to enable comparison with test results

Conservatively assume that $\mu_e = \mu_r = 1$

$$a_{w,rms} = 2\pi \times 1 \times 1 \times \frac{185}{1181.26 \times 13.6^{0.3}} \times \frac{746}{700} \times \frac{1}{\sqrt{2}} \times 0.59 = 199.95 \times 10^{-3} \text{ m/s}^2$$

Response Factor

$$R = \frac{a_{w,rms}}{0.005} = \frac{199.95 \times 10^{-3}}{0.005} = 39.99$$

Equation (38)

Comparing with the values in Section 8.3.2, the floor is unacceptable for continuous vibrations. However, as continuous vibration is unlikely to occur in residential buildings, the effect of intermittent vibrations should now be considered.

Vibration Dose Value

Maximum possible walking length of 9 m (corner to corner), assume walking at 2 Hz (average walking frequency)

$$v = 1.67f_p^2 - 4.83f_p + 4.50 = 1.67 \times 2.0^2 - 4.83 \times 2.0 + 4.50 = 1.52 \text{ m/s}$$

Equation (16)

$$T_a = \frac{L_p}{v} = \frac{9}{1.52} = 5.92 \text{ s}$$

$$n_a = \frac{1}{T_a} \left[\frac{VDV}{0.68 \times a_{w,rms}} \right]^4$$

Equation (41)

From Table 8.5, the adjusted VDV = 1.6 for low probability of adverse comment for lightweight floors during a 16 hr day

$$n_a = \frac{1}{5.92} \left[\frac{1.6}{0.68 \times 199.95 \times 10^{-3}} \right]^4 = 3239$$

Therefore the floor can be traversed 3239 times in a 16 hr day (i.e. 202 times per hr) and correspond to ‘a low probability of adverse comment’. Intuitively, for a residential building, this level of activity (average of 3 times per minute) would be very unlikely.



Silwood Park, Ascot, Berks SL5 7QN
Telephone: + 44 (0) 1344) 636525
Fax: + 44 (0) 1344) 636570

CALCULATION SHEET

Job No.	BCB 144	Sheet	5 of 6	Rev	
Job Title	P354 Design of Floors for Vibration: A New Approach				
Subject	Example No.2 – Vibration response of a lightweight floor				
Client	Made by	ALS	Date	March 2007	
	Checked by	LPN	Date	April 2007	

As this level of activity is unlikely to occur in a residential building, the floor can be classed as acceptable.

D.2.6 Finite element analysis

The first floor was first modelled without any allowance for the full-height partitions to simplify the modelling and the first three mode shapes from the finite element analysis of the floor are shown here:

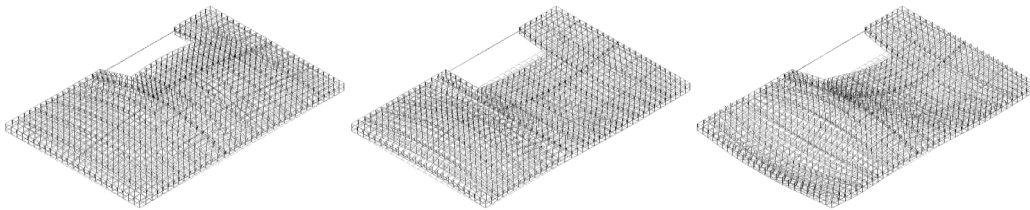

The analysis predicted a fundamental natural frequency of 16.31 Hz, which is slightly higher than the frequency predicted by the simplified method due to the constraining effect of the supporting beams.

The response analysis using the FE output calculated a response factor, $R = 53.9$, which is greater than that given by the simplified method because the supporting beams are assumed to be rigid in the simplified method, and that rigidity is not provided (by partitions) in the finite element model. A plot of response against pace frequency is shown below:

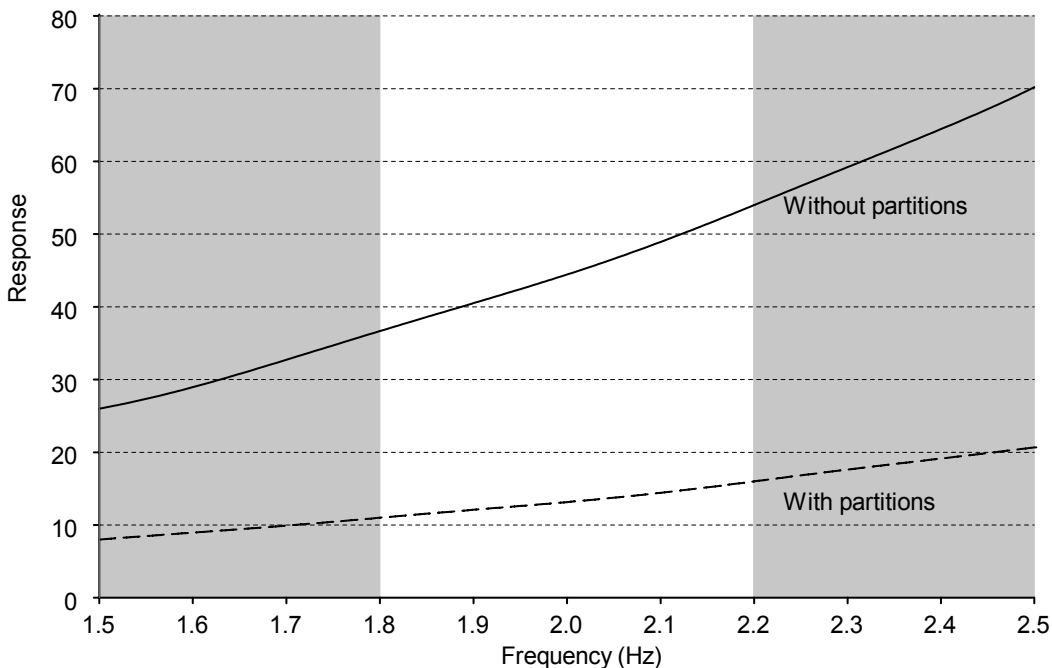



Silwood Park, Ascot, Berks SL5 7QN
 Telephone: + 44 (0) 1344) 636525
 Fax: + 44 (0) 1344) 636570

CALCULATION SHEET

Job No.	BCB 144	Sheet	6	of	6	Rev
Job Title	P354 Design of Floors for Vibration: A New Approach					
Subject	Example No.2 – Vibration response of a lightweight floor					
Client	Made by	ALS	Date	March 2007		
	Checked by	LPN	Date	April 2007		

By introducing an effective partition into the FE model, as described in Section A.5, the response factor reduces to $R=16.2$, which means the floor can be considered to be acceptable for continuous vibrations. However, the effect of partitions needs to be determined on a case-by-case basis, as different materials and connections will have greater or lesser effects, and the required research has not been performed to give definitive design rules for partitions.

D.2.7 Test results

Instrumented shaker testing found that the lowest frequency of the floor was 5.9 Hz, but this was a global mode involving not just the floor under consideration, but also the partitions and other floors. The lowest frequency that affected just the floor under consideration was found to be 14.0 Hz, which is similar to the frequency found in the simplified method.

Walking tests gave a maximum response factor, $R = 16.5$, at a pace frequency of 2 Hz. Clearly, this is very similar to the value obtained in the FE analysis.



Silwood Park, Ascot, Berks SL5 7QN
 Telephone: + 44 (0) 1344) 636525
 Fax: + 44 (0) 1344) 636570

CALCULATION SHEET

Job No.	BCB 144	Sheet	1 of 3	Rev
Job Title	P354 Design of Floors for Vibration: A New Approach			
Subject	Example No.3 – Strength design for rhythmic activity			
Client	Made by	SJH	Date	March 2007
	Checked by	ALS	Date	March 2007

D.3 Design for rhythmic activity

This example demonstrates the effect of multiple participant aerobic activity on a composite floor structure. The additional imposed load due to the activity is calculated. The floor is composed of a 160 mm lightweight concrete slab supported by 9 m span secondary beams which, in turn, are supported by 6 m and 9 m primary beams.

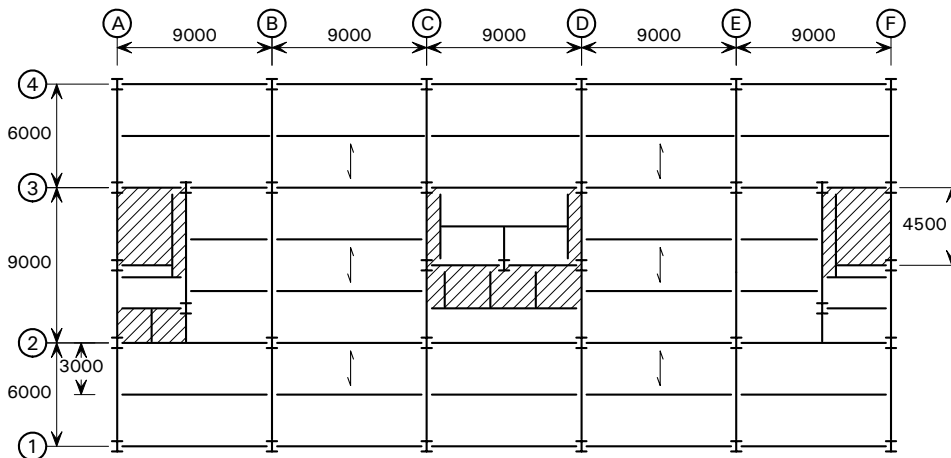

Floor and beam data

Floor structure:

160 mm deep lightweight concrete slab cast on top of 0.9 mm thick trapezoidal deck. Slabs supported by 9.0 m span secondary beams at 3.0 m cross-centres which, in turn, are supported by primary beams in the orthogonal direction on grid-lines B to E.

Main beam sizes:

9.0 m secondary beam:	305 × 165 UB 40	(Grade S275)
9.0 m primary beam:	610 × 229 UB 101	(Grade S275)
6.0 m primary beam:	356 × 171 UB 51	(Grade S355)
9.0 m perimeter beam:	356 × 171 UB 51	(Grade S275)

A finite element analysis has been carried out on the floor. From the results of this model, it is possible to evaluate the dynamic crowd loading taking:

Input data

- a damping ratio of $\zeta = 1.6\%$
- a static crowd load of $q = 0.8 \text{ kN/m}^2$ (1-person per m^2)
- an activity frequency range for large groups (1.5 to 2.8 Hz)
- normal jumping activities (contact ratio $a_c = 1/3$).



Silwood Park, Ascot, Berks SL5 7QN
 Telephone: + 44 (0) 1344) 636525
 Fax: + 44 (0) 1344) 636570

CALCULATION SHEET

Job No.	BCB 144	Sheet	2 of 3	Rev
Job Title	P354 Design of Floors for Vibration: A New Approach			
Subject	Example No.3 – Strength design for rhythmic activity			
Client	Made by	SJH	Date	March 2007
	Checked by	ALS	Date	March 2007

FE results

The results from modelling and the fundamental mode shape of the structure are shown below:

Fundamental frequency, $f_1 = 8.1$ Hz

Modal mass, $M = 12070$ kg

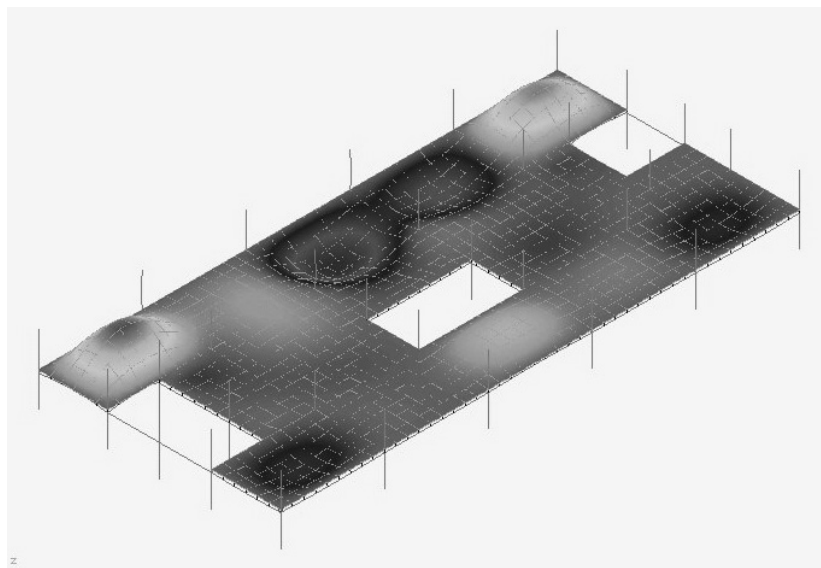

Mode shape for mode of vibration to be considered ($f_1 = 8.1$ Hz)

The frequency of the floor is 8.1 Hz, and the activity frequency needs to be taken as an integer divisor of this frequency to give the worst response. To give an activity frequency in the required range (see Section 8.1.2):

$$f_p = \frac{f_1}{h} = \frac{8.1}{3} = 2.7 \text{ Hz}$$

Equation (55)

The load at any time, t , is calculated from the following Equation

$$F(t) = q \left\{ 1.0 + \sum_{h=1}^H \alpha_h D_{\delta,h} \sin(2h\pi f_p t + \phi_h + \phi_{1,h}) \right\}$$

Equation (52)

The worst case is when the sine term is equal to unity. This happens when the harmonic is in phase with the loading cycle. Assuming this to be the case, the equation reduces to:

$$F = q \left(1.0 + \sum_{h=1}^H \alpha_h D_{\delta,h} \right)$$

Equation (54)

In this example, only the first three harmonic components of the activity are considered for ultimate limit state conditions. For normal jumping activities, the Fourier coefficients for the first three harmonic components are: 1.800, 1.286 and 0.667.

Table 3.3



Silwood Park, Ascot, Berks SL5 7QN
 Telephone: + 44 (0) 1344) 636525
 Fax: + 44 (0) 1344) 636570

CALCULATION SHEET

Job No.	BCB 144	Sheet	3 of 3	Rev
Job Title	P354 Design of Floors for Vibration: A New Approach			
Subject	Example No.3 – Strength design for rhythmic activity			
Client	Made by	SJH	Date	March 2007
	Checked by	ALS	Date	March 2007

The dynamic magnification factor, is given by:

$$D_{\delta,h} = \frac{1}{\sqrt{(1 - h^2 \beta^2)^2 + (2h\zeta\beta)^2}}$$

Equation (53)

where h is the number of the h th harmonic, β is the ratio of the applied load frequency to the natural frequency of the system and ζ is the damping ratio.

$$\beta = 2.7 \text{ Hz} / 8.1 \text{ Hz} = 1/3$$

For the first harmonic component:

$$D_{\delta,1} = \frac{1}{\sqrt{(1 - 1^2 \times 1/3^2)^2 + (2 \times 1 \times 0.016 \times 1/3)^2}} = 1.12$$

Second harmonic component:

$$D_{\delta,2} = \frac{1}{\sqrt{(1 - 2^2 \times 1/3^2)^2 + (2 \times 2 \times 0.016 \times 1/3)^2}} = 1.80$$

Third harmonic component:

At resonance the expression for $D_{\delta,h}$ simplifies to:

$$D_{\delta,3} = \frac{1}{2\zeta} = \frac{1}{2 \times 0.016} = 31.25$$

The total load is:

$$F = 0.80 (1.0 + 1.8 \times 1.12 + 1.286 \times 1.80 + 0.667 \times 31.25) = 20.94 \text{ kN/m}^2$$

Note that the static imposed load used for design of the floor was 3.5 kN/m^2 , which gives a ULS loading of $3.5 \times 1.6 = 5.6 \text{ kN/m}^2$

As can be seen, the imposed load due to the dynamic activity is significantly higher than the static ULS design load for the floor. The floor would need to be strengthened to withstand a ULS load of 20.94 kN/m^2 (with $\gamma_f = 1.0$) if the aerobic activity were to take place. If the harmonics are assumed not to be in phase, and Equation (52) was used, the total load for this more precise calculation is 19.9 kN/m^2 .

