

# The acoustics of orchestra pits

A case study: Het Muziektheater, Amsterdam



Project: M4, Graduation project

Name: A.H.M. van der Heide

Student ID: 0531216

Supervisors:

Prof. Ir. L.C.J. van Luxemburg

Ir. C.C.J.M. Hak

Ir. R.H.C. Wenmaekers

Department:

Physics of the Built Environment

Department of Architecture

Eindhoven University of Technology

Date: April 2011

## SUMMARY

Following the problems with loudness and ensemble playing in the orchestra pit of Het Muziektheater a research has been performed regarding the acoustic of orchestra pits. A study of pervious research has shown that Het Muziektheater is not unique dealing with this problem; based on a survey among 46 theatres worldwide excessive sound levels are an issue in two third of the orchestra pits and in nearly half of the pits hearing other orchestra members was considered to be difficult.

Earlier investigations have mainly focused on sound transmission from pit to audience and not on the acoustics of the orchestra pit itself. To collect reference material measurements were performed in four Dutch orchestra pits: Het Muziektheater (Amsterdam), Theater aan de Parade (Den Bosch), Theater De Vest (Alkmaar) and Stadsschouwburg (Eindhoven).

Thereafter the acoustics of the orchestra pit of Het Muziektheater were further studied using a 1:10 scale model. The influence of a lower floor position, addition of diffusers and addition of absorbers on the acoustics within the pit was assessed. Prior to this study 1:10 absorption properties of several materials were assessed in a 1:10 scale model of a reverberation room and the measurement method and system calibration methods were investigated. The measurements in het basic setup of the scale model have shown a good correlation to the measurements in het orchestra pit of Het Muziektheater (MZT). The assessment of different pit configurations has yielded a first insight into the trends that are to be expected when applying diffusers/absorbers or lowering the floor.

## CONTENTS

summary.....	2
1 Introduction.....	5
1.1 Acoustic issues in orchestra pits .....	5
1.2 The orchestra pit of Het Muziektheater .....	6
1.3 Previous research in orchestra pits .....	8
1.4 Method to assess possible pit improvements.....	9
2 Reference measurements in four Dutch orchestra pits.....	10
2.1 Working method .....	10
2.1.1 Selection of orchestra pits .....	10
2.1.2 Measurement procedure .....	12
2.1.3 Parameters .....	16
2.1.4 Reference: stage acoustics .....	21
2.1.5 Expectations .....	21
2.2 Main results and analysis .....	23
2.2.1 Comparison based on average values.....	23
2.2.2 Analysis by octave bands .....	26
2.2.3 Analysis by receiver position .....	27
2.2.4 Influence of source-receiver distance.....	29
2.2.5 Diffusers versus curtains .....	30
2.3 Evaluation and goals for measurements in scale model.....	32
3 Assessment of a 1:10 scale model of the orchestra pit in Het Muziektheater .....	34
3.1 Preliminary investigations.....	34
3.1.1 Building the model .....	34
3.1.2 Measurement method.....	35
3.1.3 Validation of the scale model.....	37
3.2 Assessment of different pit configurations.....	41
3.2.1 Measurement setup .....	41
3.2.2 Influence of pit configurations on acoustic properties .....	42
3.3 Evaluation of the results .....	47

4	CONCLUSIONS .....	48
4.1	the acoustics in orchestra pits .....	48
4.2	use of new parameters and system calibration for scale model measurements .....	49
5	recommendations for further research .....	50
	References .....	51
	Acknowledgements .....	53
	Appendix I: System calibration for measurements in orchestra pits .....	54
	Appendix II: Overview of measurement results orchestra pits .....	55
	Appendix III: Assessment of materials for scale model.....	57
	Introduction.....	57
	Method .....	57
	Results .....	60
	Conclusion.....	63
	Appendix IV: Development of the measurement method for the scale model investigations .....	64
	Appendix V: Overview of measurement results scale model.....	68

# 1 INTRODUCTION

## 1.1 ACOUSTIC ISSUES IN ORCHESTRA PITS

Orchestra pits were developed in Italy in the 16<sup>th</sup> century, where the first opera houses were built. Currently their main use is still for opera, but also for musical and ballet performances. Very often the orchestra pit is partly covered by the stage, which is typically done for two reasons: Sound from the orchestra is muffled, which enhances the balance between sound from singers on stage and the musicians in the pit respectively; furthermore by placing the orchestra partly underneath the stage, more seating rows can be placed in the auditorium and more tickets can be sold.

Whether placing the orchestra partly underneath the stage truly enhances the balance between singer and orchestra is questionable. Gade (1998) studied three different pit configurations at the Royal Theatre in Copenhagen and found that the measured differences in the auditorium hall were very small when the three situations were compared, while significant variations were found in the pit itself. Gade (1998) therefore concluded that lowering and covering the pit does not affect the balance between orchestra and singer in the auditorium hall.

Unfortunately most acoustic problems seem to be caused by this overhang. [Heide, van der, 2010] The following top 5 of orchestra pit problems was composed based on an international survey among 46 theatres by Gade, et al. (2001):

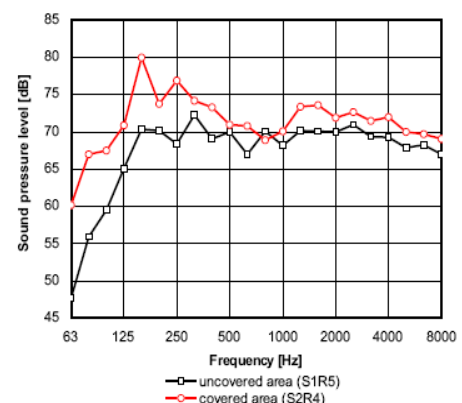
**Table 1: Top 5 problems in orchestra pits, based on a survey among 46 theatres worldwide. [Gade, 2001]**

Problem	'Yes'
Excessive sound levels	69%
Lack of space	68%
Difficulties arranging orchestra seating	48%
Difficulties hearing other orchestra members	46%
Lacking quality of sound	36%

Sound levels are often higher than 90 dB during performances, due to which musicians are at risk of developing hearing damage. Drotleff and Leistner (2007) studied sound levels in the open and covered part of an orchestra pit and found significant differences, especially at low frequencies, see Figure 1. Lee, et al. (2005) however concluded that the sound exposure during performances is not excessive when averaged over an 8 hour working day, based on measurements during 18 rehearsals/performances of the Canadian Opera Company.

During a research by Peutz (2003) a comparison was made between sound levels on stage and in an orchestra pit. They concluded that the differences were in the range of 2 to 3 dB, the latter meaning a doubling of the sound energy. Besides sound levels the size of the pit is often problematic ('lack of space') and the ensemble conditions are often poor ('difficulties hearing other orchestra members', 'lacking quality of sound'). For good ensemble conditions the following aspects are important: [Barron, 1993]

- The ability to hear yourself
- The ability to hear others
- Feedback from the hall: musicians like to feel connected to the space they perform in, and therefore prefer to hear some reverberant sound.
- Timing: when musicians are far apart, sound will not be transmitted fast enough for good timing. Generally early sound supports ensemble, while late sound can blur information. At the same time a certain amount of late sound is important for the sense of reverberance from the hall.



**Figure 1: Results of measurements in open and covered area of an orchestra pit [Drotleff & Leistner, 2007]**

To achieve satisfactory ensemble conditions within an orchestra pit is highly challenging. Even before Sabin developed his famous formula, Wagner took several measures to enhance acoustics in his design for the pit of the Bayreuth Festspielhaus. He placed brass instruments underneath a sound absorbing screen, while above the string players a resonating plane consisting of thin panels was constructed. (Habel, 1985) At that time possibly dangerous sound levels were not an issue; that became current as regulations for musicians' working conditions were introduced. In the late 20<sup>th</sup> and early 21<sup>st</sup> century many possible solutions to improve acoustic conditions in the orchestra pit were assessed:

- Changing the orchestra arrangement
- Sound screens between musicians
- Ear plugs
- Diffusers at walls and/or ceiling
- Absorbers at walls and/or ceiling

More information about the acoustic issues in orchestra pits and possible solutions can be found in [Heide, van der, 2010].

## 1.2 THE ORCHESTRA PIT OF HET MUZIEKTHEATER

The performance hall of Het Muziektheater is fan-shaped and relatively small with 1689 seats and a volume of app. 10.000 m<sup>3</sup>. With 180 m<sup>2</sup> the orchestra pit is however the largest in The Netherlands. Figure 2 shows a cross section of the auditorium hall. Photos of the orchestra pit are displayed in Figure 3.

The pit is partly covered by the stage and highly adaptable due to four independent pit lifts. Although many arrangements are possible, the most common situation is with the middle and side lifts leveled with the fixed floor. In that situation three seating rows can be placed at the arena lift, see Figure 4 and Figure 5 (next page).

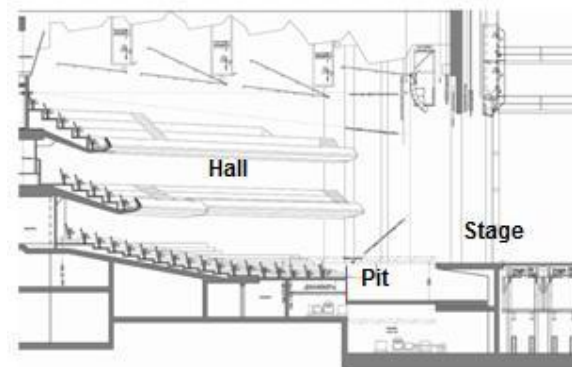


Figure 2: Vertical cross-section of the auditorium hall

Originally sound absorbers (6 cm mineral wool with perforated metal sheets) were installed at the rear wall of this orchestra pit, and plywood linings and curtains were applied to reduce low and high frequency sound respectively. All of these were however removed, because the sound perceived by the audience was not loud enough and the bare concrete would generate stronger reflections. [Lange, et al., 1996] Due to that and due to the introduction of an electronic amplification system the loudness in the hall is now satisfactory. However, the loudness has become a problem in the pit itself: musicians are at risk of developing hearing damage.

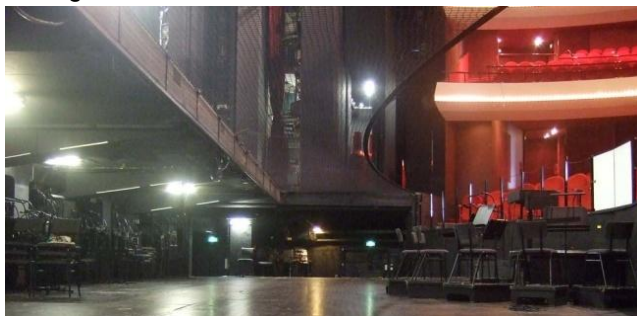


Figure 3: Photos of the orchestra pit of Het Muziektheater

Sound level measurements were performed by Level Acoustics on August 28 and 29, 2008, during a rehearsal and performance of “Die Frau ohne Schatten” (R. Strauss) by the Dutch Philharmonic Orchestra. The orchestra consisted of 105 musicians (i.e. 1,7 m<sup>2</sup>/person) at the time. All measurements were performed according to Dutch regulations. These regulations state that the average sound level on a working day (8 hours) should not exceed 85 dB, while the maximum allowed peak level is 140 dB. When these requirements are not met, hearing protection is strongly advised. [NEN 3418:2003]

At three out of four measurement positions the average sound level during the performance was measured to be above 85 dB, thus too high. Although the maximum sound level was not reached, peaks >100 dB occurred every 5 minutes. Level Acoustics advised to investigate measures to protect the musicians’ ears, and to experiment with the use of ear plugs. [Level Acoustics, 2008]

These results combined with persistent complaints from musicians about both sound levels and ensemble conditions have led to a brainstorm session on November 24<sup>th</sup>, 2009. During this meeting several solutions were considered: [Vries, de, 2009]

1. Removal of the front three seating rows.
2. Opening the so-called “timpani holes”
3. Adding absorption material under the stage floor at the covered part of the pit.
4. Placement of a tilted reflector behind the orchestra.
5. Installing a grated floor through which sound can reach the space underneath the pit.
6. Placement of screens near the loudest instruments.

Solutions 1 and 3 were preferred by the persons present. A seventh possible solution, which has been applied in several Dutch theatres, is the following:

7. Diffusers at the rear wall

Finally, there is an ongoing discussion in Het Muziektheater whether removal of the elevated wooden floor would improve the acoustics. This elevated floor was built on top of the concrete fixed floor, and by removing it the whole floor area (including pit lifts) could be lowered by 40 cm, see Figure 5.

Although measures such as adding absorbing materials and placement of diffusers have been applied before in other pits, there is very little data showing their influence on the acoustic properties of those pits, see next paragraph. It was therefore decided to assess the influence of such measures on the acoustic properties of orchestra pits, especially the orchestra pit of Het Muziektheater.

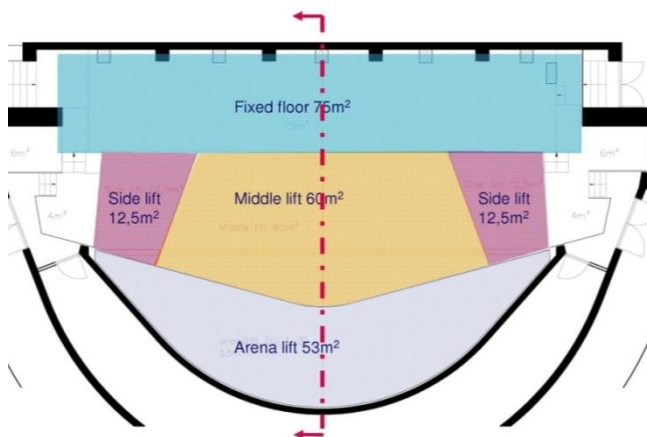


Figure 4: Floorplan of orchestra pit

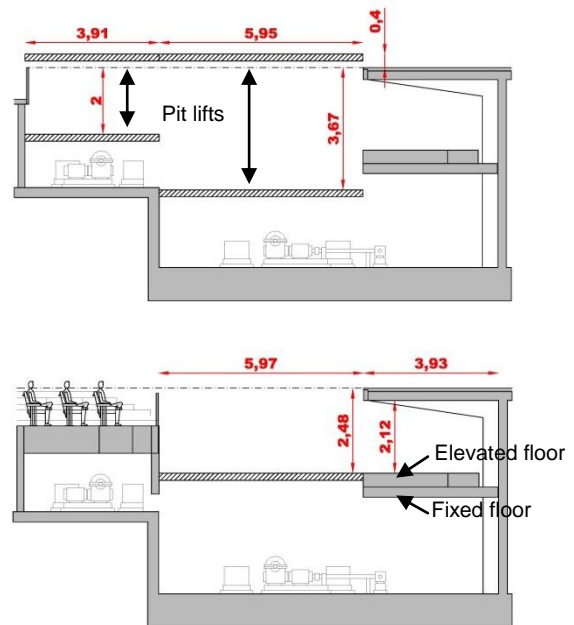


Figure 5: Section of orchestra pit, left: extreme positions of pit lifts, right: most common layout.

### 1.3 PREVIOUS RESEARCH IN ORCHESTRA PITS

As the main concerns in orchestra pits are usually the sound levels, appliance of absorption materials might seem the most sensible solution. Both Barron (1993) and Gade et al. (2001) however argue that appliance of absorptive surfaces decreases the ease of ensemble playing and will urge the conductor to ask for a louder playing volume.

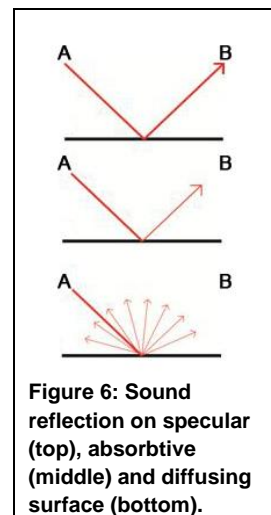
During a research at the Royal Theatre in Copenhagen the influence of an absorptive material at the front wall of the orchestra pit was assessed. Surprisingly no changes in G and EDT were found, while the  $ST_{early}$  decreased significantly (1-2 dB).<sup>1</sup> Hence instead of reducing the sound levels at musicians' ears as intended, the ease of ensemble playing was reduced instead. [Gade, 1998] Gade therefore advocates well considered seating arrangements, use of sound screens and perhaps a more considerate performance to solve the problem of loudness.

Zha et al. (2002) acknowledge the communication problems due to absorption of sound, but have found that in most orchestra pits the bass frequencies cause a strong rumbling sound due to resonance. However, most low frequency (LF) absorbers (bass-traps) are quite voluminous: an unfavorable characteristic in an orchestra pit. An innovative solution is the Compound Baffle Absorber (CBA) – recently developed by Fraunhofer-Institut für Bauphysik – which has a thickness of only 10 cm and reaches its maximum sound absorption between 50 and 100 Hz. This new absorber panel was tested in the orchestra pits of the Staatstheater Stuttgart and the Landestheater Flensburg, both with good results. Due to a reduced reverberation time, and because the rumbling sound did no longer occur, the clarity in the pit was improved. [Zha et al., 2002]

After experiments with different types of absorbers in different configurations at the rear wall of the orchestra pit in Stuttgart, Zha et al. (2002) claim to have reached a sound reduction in the order of 5-7dB within the pit. Furthermore the clarity was increased dramatically: up to 10dB at low frequencies (125Hz) and an average of 5dB at higher frequencies.

Other research on this topic has mainly focused on sound transmission from pit to audience, and/or the balance between singer and orchestra. Hidaka and Beranek (2000) for example performed measurements in 23 opera houses throughout Europe with sound sources on stage and in the orchestra pit. Halmrast (2002) studied the influence of different reflectors above the orchestra pit at the Norwegian National Opera on sound transmission to stage and audience, while Parati, et al. (2007) assessed the influence of different railing heights on sound transmission to the audience.

Previous research on the influence of diffusers in orchestra pits is not known to the author. Theoretically diffusing panels should create a more uniform sound field, which would enhance ensemble conditions. When considering sound transmission from A to B (Figure 6), both an absorptive and a diffusing surface will attenuate the sound at B. With many sound source present however (such as an orchestra), a diffusing surface will not cause an overall attenuation of sound.



Appliance of diffusers is quite common in auditorium halls, on stages and in orchestra pits, such as the pit of 'De Kunstlinie' ( Almere), 'Het Muziekcluster' (Enschede), and 'Stadsschouwburg' (Eindhoven).

<sup>1</sup> According to ISO/DIS 3382-1:2006 (E) the just noticeable difference (JND) of  $ST_{early}$  is unknown. However, for G and  $C_{80}$  a JND of 1dB is assumed. Based on this knowledge a difference of 1 to 2 dB can be considered significant.



## 1.4 METHOD TO ASSESS POSSIBLE PIT IMPROVEMENTS

In the orchestra pit of Het Muziektheater, Amsterdam, both high sound levels and poor ensemble conditions are an issue. This research aims to assess the influence of architectural measures on the acoustic conditions in this orchestra pit, and consists of two parts:

1. Assessment of the acoustics in four Dutch orchestra pits.
2. Assessment of possible pit improvements in the orchestra pit of Het Muziektheater using a scale model.

By performing measurements in different orchestra pits reference material was collected. The acoustic properties of the orchestra pits were compared to each other and to a stage situation. Furthermore the most relevant parameters were selected based on these measurements and goals for the second part of the research were determined.

The influence of the following measures was assessed:

- Diffusers at the rear wall, and at the front wall
- Absorbers at the rear wall, and at the ceiling
- Lowering the floor by 40 cm

It was decided to build a 1:10 scale model instead of a computer model, because current (available) software is not capable of accurately modeling the influence of sound diffusers.

In the following chapter the most significant results of measurements in four different orchestra pits are presented and analyzed. The third chapter contains information about the scale model, the measurement procedure and an analysis of the influence of different pit configurations. In the final chapter the results are discussed, the main conclusions are presented and suggestions for further research are given.

## 2 REFERENCE MEASUREMENTS IN FOUR DUTCH ORCHESTRA PITS

### 2.1 WORKING METHOD

In this paragraph the main characteristics of the orchestra pits that were selected for measurements are presented, followed by the measurement procedure and an overview of the parameters that were used for analyses. Finally the acoustic properties of several stages are presented – to serve as a reference for the acoustics in the pits – and some expectations regarding the measurement results are formulated.

#### 2.1.1 SELECTION OF ORCHESTRA PITS

A total of four orchestra pits was selected to assess the acoustic properties of orchestra pits, see Figure 7. Both the orchestra pit of the Theater aan de Parade and the Stadsschouwburg are considered to have rather good acoustic properties, while the acoustic situation in the pit in De Vest is known to be bad. Those three pits have served as a reference for the acoustics of the pit in Het Muziektheater.

**Het Muziektheater, Amsterdam (MZT)**



**Theater aan de Parade, Den Bosch (PAR)**



**De Vest, Alkmaar (VES)**



**Stadsschouwburg, Eindhoven (STS-D/STS-C)**



**Figure 7: Selection of orchestra pits**

In the subsequent part of this report, the orchestra pits will be referred to using abbreviations as in Figure 7. In the orchestra pit of the Stadsschouwburg Eindhoven two setups were measured:

- With diffusers at the rear wall -> STS-D
- With a heavy curtain covering the diffusers -> STS-C

The main characteristics of these orchestra pits (dimensions and material use) are listed in Table 2 and 3.

**Table 2: Dimensions of orchestra pits**

Description	MZT	PAR	VES	STS
Total floor area	180 m <sup>2</sup>	104 m <sup>2</sup>	47 m <sup>2</sup>	142 m <sup>2</sup>
% open pit	42 %	40 %	34 %	37 %
Width	20,0 m	13,8 m	10,9	22,8
Length	9,9 m	9,0 m	5,5	7,1
Depth rel. to stalls floor	1,4 m	2,5 m	-	1,5 m
Ceiling height covered part	2,1 m	2,4 m	-	2,2 m
Setup during measurements	Leveled floor	Fixed floor -43 cm relative to the moveable floor of the open part.	Leveled floor	Fixed floor -37 cm relative to the moveable floor of the open part.

**Table 3: Material use in orchestra pits**

Surface	MZT	PAR	VES	STS
Back wall	Painted concrete	Painted concrete with heavy curtain	Storage front seating rows	STS-D: Concrete with ca. 20 diffuser panels 60 x 60 x 22,5 cm <sup>3</sup> STS-C: Idem, covered by heavy curtain
Front wall	Wooden panels	Painted concrete	0-1 m: Storage area, covered by heavy curtain Above: Wooden panels	Painted bricks
Side walls open part	Painted concrete	Concrete with carpet glued onto surface	Idem front wall	Concrete, wooden doors
Side walls covered part	Painted concrete	Porous grey bricks	Idem back wall	Painted bricks
Fixed floor	Concrete with 40 cm wooden elevation.	Linoleum on concrete	Concrete	Linoleum on concrete
Moveable floor	Wooden panels	Wooden panels	Not present	Wood on steel
Ceiling covered part	Painted concrete	Painted wooden panels	Steel construction and concrete	Painted concrete

Figure 8 displays pictures of the rear walls of all orchestra pits. It is expected that the surface treatment of these walls has considerable influence on the acoustics of each pit. A short description of each rear wall and a prediction of their effect on the acoustics:

- MZT: Concrete rear wall with large metal ventilation ducts. The irregular surface of the rear wall (due to construction and ducts) might cause some diffusion of sound, but very little absorption.
- PAR: The heavy curtain at the rear wall will absorb sound energy most likely at mid and high frequencies.
- VES: This pit does not really have a rear wall as it borders a storage area both in the front and in the back. At the front the storage area is covered by a curtain, but in the back it is not. The stored chairs will most likely be highly sound absorptive (mid and high frequencies), which will result in a very short reverberation time.
- STS: Two arrangement were measured; first with diffusers at the rear wall, and second with curtains covering the diffusers. Those curtains will mainly absorb sound at mid and high frequencies. Because the curtains will not be 100 % absorptive, the diffusers will still influence the acoustic properties of the pit.

MZT



PAR



VES



STS-D STS-C



Figure 8: Rear walls of orchestra pits

## 2.1.2 MEASUREMENT PROCEDURE

### Measurement setup

Measurements were performed with an omnidirectional sound source and two microphones, see Figure 9. Dirac 4.0 was used to record the impulse response measurements. During all measurements the same microphones were used on the same channels to minimize system errors. An e-sweep of 5,46 s (1x pre-averaging) was used for each measurement, sufficiently loud to achieve an INR > 45 dB. The INR (Impulse response to Noise Ratio) is an important parameter to determine the reliability of measurement results. [Hak, Hak and Wenmaekers, 2008] According to ISO 3382-1 (2006) the INR should be at least 45 dB to determine the reverberation time ( $T_{30}$ ).

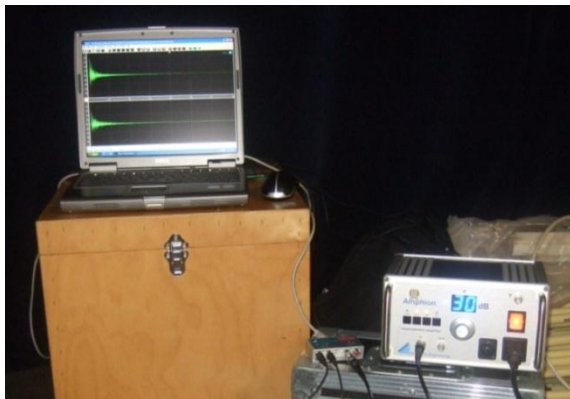


Figure 9: Equipment; laptop and amplifier (left), omnidirectional sound source and two microphones (right)

The following figure shows the measurement setup:

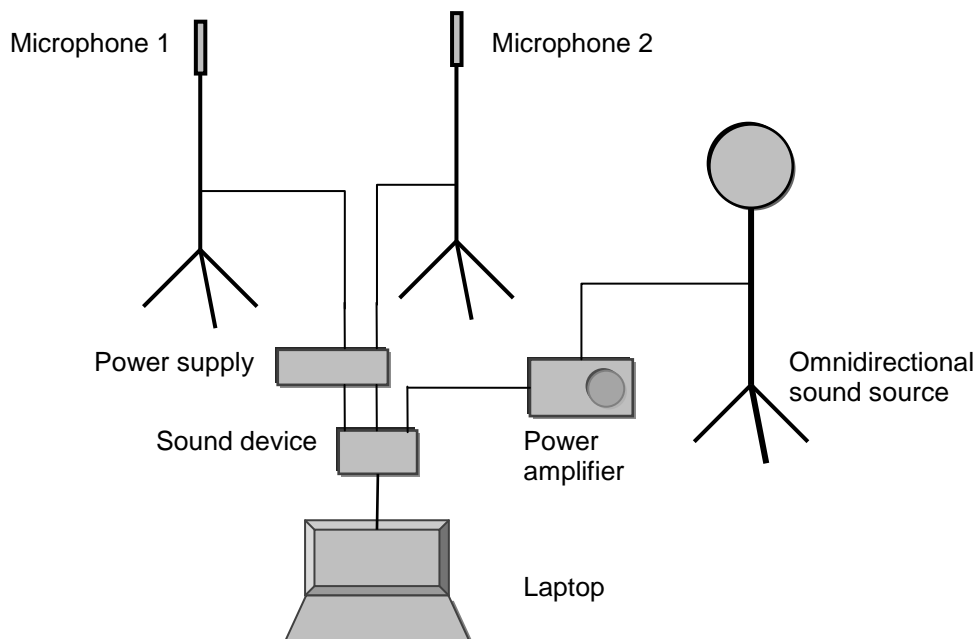


Figure 10: Measurement setup

### Measurement positions

The following transmission paths are to be assessed based on the measurements:

- Within the pit:
  - covered ↔ covered
  - open ↔ open
  - open ↔ covered (also referred to as 'across')
  - covered / open → conductor
- From the pit:
  - to the stage
  - to the audience

For all transmission paths both short and long distance transmission are of interest, see Figure 11.

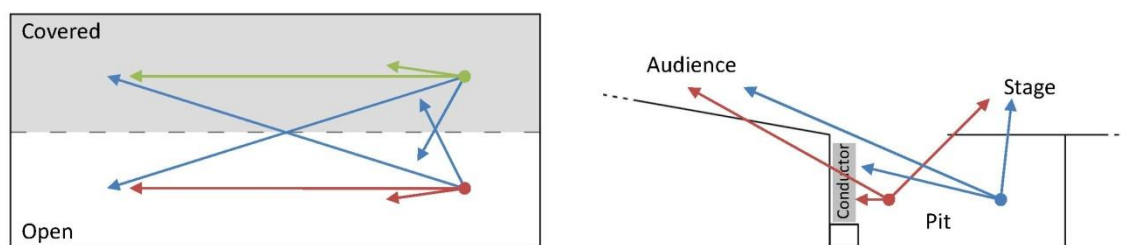


Figure 11: Schematic representation of sound transmission paths within an orchestra pit (left) and from pit to hall/stage (right)

Based on the schemes displayed above source (S) and receiver (R) positions were chosen as depicted in Figure 12:

- S1/R1: positioned 1m from the rear wall, at 1/6 of the pit width.
- S2/R2: positioned 1m from the stage edge at 1/3 of the pit width.
- S3/R3: positioned at the open part of the pit, at 1/6 of the pit width.

R4 is located close to the sources to measure short distance sound transmission with, while R5, R6 and R7 are located at the other side of the pit, symmetric to the source positions. Finally a receiver (R<sub>C</sub>) is located at the conductor's position, 75 cm from the front wall.

To assess the sound transmission between orchestra pit and stage / auditorium hall, a fourth source position (S<sub>S</sub>) and one receiver position (R<sub>S</sub>) were located on stage and two receivers (R8 and R9) were located in the hall.

The early and late support are to be calculated based on measurements at 1 m from the sound source according to ISO/DIS 3382-1 (2006). To obtain more robust results two receiver positions were chosen at 1 m from each source.

All receivers were set at 1,20 m height, which is in line with ISO/DIS 3382-1 (2006), while the source was set at 1,35 m height, because the tripod does not allow a lower position. Furthermore all measurements were performed four times, while stepwise rotating the source 90 degrees to compensate for it not being fully omnidirectional.

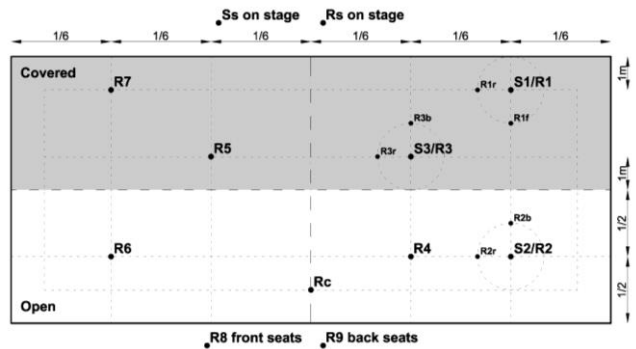


Figure 12: Schematic representation of source and receiver positions

Figure 13 shows the measurement positions in the four orchestra pits, while Figure 14 displays the positions of R8 and R9 in the different auditorium halls.

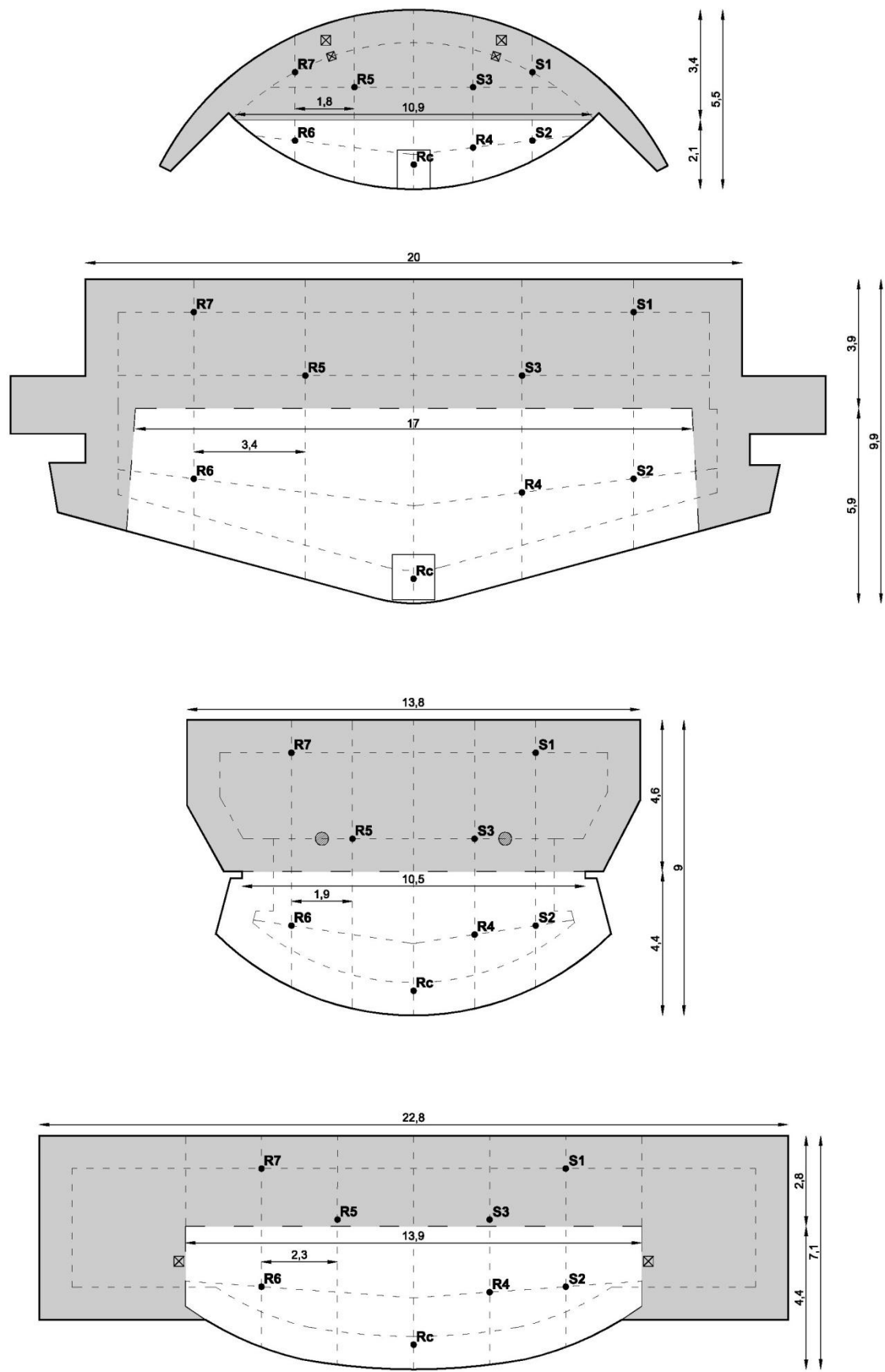
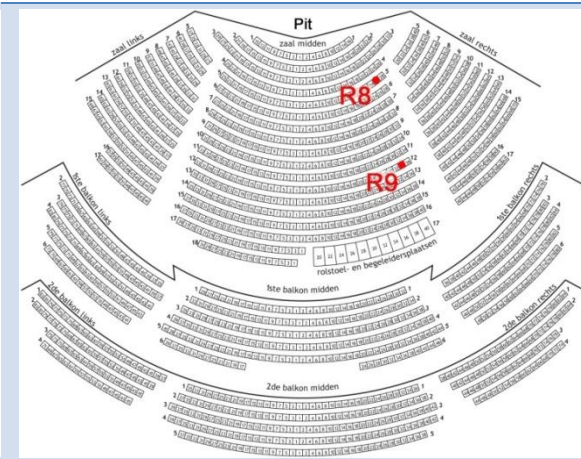


Figure 13: Measurement positions in the orchestra pits. Top to bottom: MZT, PAR, VES, STS. Dimensions in meters.

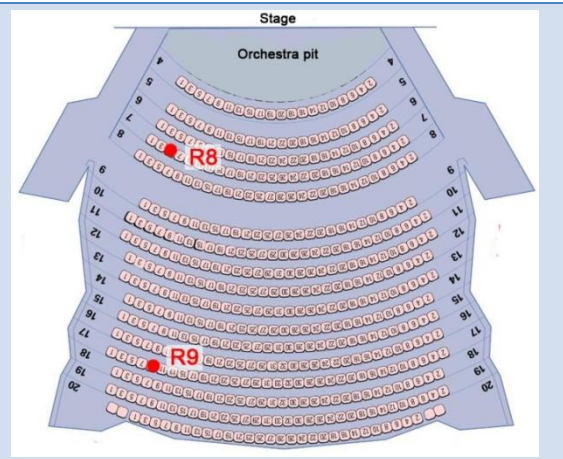
### MZT

R8: Row 5, seat 26; R9: Row 12, seat 34



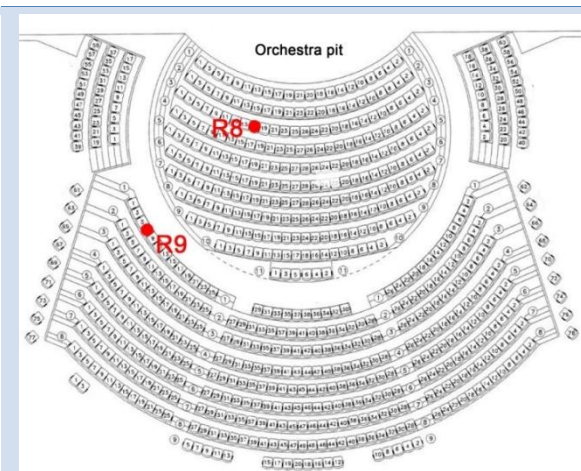
### PAR

R8: Row 7, seat 5; R9: Row 17, seat 9



### VES

R8: Row 3, seat 17; R9: Row 1 (fixed seats), seat 7



### STS

R8: Row 4, seat 19; R9: Row 12, seat 19

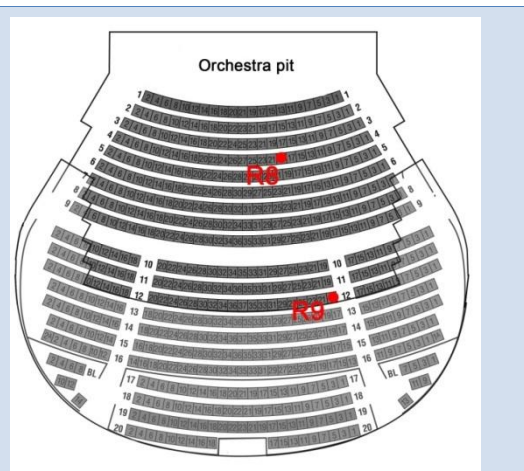


Figure 14: Positions of R8 and R9

## 2.1.3 PARAMETERS

### Current state of knowledge

Over the past decades a wide range of room acoustic parameters has been defined, all of which can be derived from impulse response measurements. The most widely recognized parameters have been included in international standards, such as ISO/DIS 3382-1 (2006). However, even those parameters still have their pros and cons and undeniable evidence of their relation to personal experience is hard to obtain. Bradley (2010) has written an interesting paper about the missing information regarding ISO parameters. His final sentence “*There is so much we need to understand better!*” says it all.

For example, the reverberation time ( $T$  or  $T_{30}$ ) is still an important reference for a first impression of acoustic conditions within a space, but can often not be directly related to subjective experience. For an indication of the subjective experience in the auditorium hall the Early Decay Time (EDT) has been defined. To assess the sense of reverberance on stages however the Late Support ( $ST_{late}$ ) is more commonly used, but recently Dammerud, et al. (2010) suggested the Late Strength ( $G_l$ ) to be more physically reliable than Late Support.

The acoustics for symphony orchestras on stages has been a subject of research since the 1980s. Gade (2010) recently published an article about the things we have learned from such research over



the past 30 years. Again finding relations between the subjective experience of musicians and objective data has proved to be difficult. There are several factors complicating the research:

- Subjective judgment by musicians/conductors: It is hard to obtain reliable data from musicians and conductors. After evaluation of a large number of questionnaires Gade (2010) concluded that musicians do not distinguish between different subjective aspects such as hearing yourself, hearing others, sense of reverberance etc. Consequently only an Overall Acoustic Impression (OAI) could be derived. Subjective judgments are also influenced by non-acoustic aspects such as thermal comfort, lighting, how well the hall is known etc. Dammerud (2009) for example found that the least preferred halls received most comments on poor thermal comfort.
- Measurement conditions: Ideally measurements would be performed with a full orchestra present on stage. To compare different halls the same orchestra with the same arrangement should travel with the acousticians for all measurements. As this is generally far too expensive, most measurements are performed on empty stages or experiments are carried out in lab setups. To draw sensible conclusions from such measurements is highly challenging, as the orchestra has a considerable and quite unpredictable influence on sound reflection patterns. Dammerud (2009) presents some interesting results regarding sound transmission within orchestras in his paper.
- Comparison of results: Research on stage acoustics has been performed in theatres around the globe, comparing questionnaire answers to measurement results. There is however no general method to perform this kind of research, and consequently all researchers have used different approaches. A comparison of the results is therefore difficult. [Gade, 2010]

### **Selection of parameters**

During those decades of research a number of new parameters have been developed for analysis of stage acoustics. Although further research is necessary to prove their relevance, some of those parameters might be interesting for research in orchestra pits as well. After a literature study regarding stage acoustic research, the following parameters were selected for an assessment of the acoustic conditions in orchestra pits:

- Reverberation time:  $T_{30}$  [s]
- Early Decay Time: EDT [s]
- Sound strength: G [dB]
- Early strength:  $G_{5-80}$  [dB]
- Level quotient:  $LQ_{7-40}$  [dB]
- Early support:  $ST_{early}$  [dB]
- Late support:  $ST_{late}$  [dB]
- Early-to-direct energy ratio: ED80 [dB]
- Late-to-direct energy ratio: LD80 [dB]

The underlined parameters are 'new' parameters; all others are defined in ISO 3382:1 (2006). The following paragraphs provide more information about these parameters.

### **Reverberation time: $T_{30}$ [s]**

The reverberation time ( $T$  or  $T_{60}$ ) is defined as the time in seconds it takes for a loud sound to decay 60 dB after the sound source has been switched off. Because it is difficult in practice to achieve a 60 dB decay, the time in which the sound decreases by 30 dB is often measured instead and multiplied by two. To obtain sufficiently reliable results a 45 dB difference is to be measured, as the decay range is calculated at -5 to -35 dB from the first peak of the decay curve. This way the influence of system and background noise is minimized. [Hak, et al., 2008]

### Early Decay Time: EDT [s]

The EDT is defined as the time in which the sound decreases by 10 dB *six times*, to match the reverberation time. It is said to be a measure for the subjective sense of reverberance, clarity and the overall acoustic impression of a space. Furthermore the EDT gives an indication of the diffuseness of a room, as it is theoretically equal to the reverberation time ( $T$  or  $T_{30}$ ) when a room is completely sound diffuse.

### Sound strength: G [dB]

The sound strength 'G' is an objective indicator for the sense of loudness and intimacy. It is defined as the ratio of the sound pressure at a measurement point and the sound pressure caused by the same source at 10 m distance in a free field. Sound strength is calculated based on impulse response measurements using the following formula: [ISO/DIS 3382-1:2006]

$$G \text{ dB} = 10 * \log \frac{\int_0^{\infty} p^2 t dt}{\int_0^{\infty} p_{10}^2 t dt} = L_{pE} - L_{pE,10}$$

With:

$p(t)$  instantaneous sound pressure of the impulse response measured at the measurement point;

$p_{10}(t)$  instantaneous sound pressure of the impulse response measured at a distance of 10 m in a free field;

$L_{pE}$  and  $L_{pE,10}$  are the sound pressure exposure levels of  $p(t)$  and  $p_{10}(t)$  respectively.

The instantaneous sound pressure of the impulse response measured at a distance of 10 m ( $p_{10}$ ) was determined by performing a system calibration at a reverberation room of the Acoustic Laboratory of the TU/e. The procedure is described in Appendix I.

### Level quotient: LQ<sub>7-40</sub> [dB]

According to research by Marshall et al. (1978) the very early reflections between 10 and 40ms improve ensemble conditions. Recently a new parameter, the LQ<sub>7-40</sub>, was developed to describe the relation between very early reflections (7-40ms) and late early and reverberant sound (40-∞). This parameter is to be used as a tool to fine-tune stage acoustics with. The direct sound (0-7ms) was omitted from the calculation because direct sound transmission is not influenced by the stage envelopment, hence it does not provide information about the influence of architecture on the stage acoustics. Recent studies have shown that the LQ<sub>7-40</sub> correlates well to the conductor's and musicians' experience of the acoustics on stage. [Braak, van den, & Luxemburg, van, 2008] [Braak, van den, et al., 2009]

$$LQ_{7-40} = 10 * \log \left( \frac{\int_{0,007}^{0,040} p^2 t dt}{\int_{0,040}^{\infty} p^2 t dt} \right)$$

### Early strength: G<sub>5-80</sub> [dB]

A similar parameter was proposed by Peutz [Lautenbach & Vercammen, 2010]:

$$G_{5-80} = 10 * \log \left( \frac{\int_{0,005}^{0,080} p^2 t dt}{\int_0^{\infty} p_{10}^2 t dt} \right)$$

The  $G_{5-80}$  is based on the early strength parameter ( $G_{0-80}$ ) but omits direct sound, just like LQ<sub>7-40</sub> does. A major difference between the two parameters is, that LQ<sub>7-40</sub> compares the energy of early reflected sound to that of late reflections, while  $G_{5-80}$  uses the energy measured at 10 m in a free field as reference. Secondly the time frame is different. At present there is no consensus which time frame best represents the early reflections caused by floor, walls and ceiling.

### Early support and late support: $ST_{\text{early}}$ [dB] and $ST_{\text{late}}$ [dB]

The support parameters were originally defined by Gade to judge the ease of hearing other orchestra members and the feedback from the hall respectively. Both parameters are now included in ISO/DIS 3382-1 (2006) Annex C. The parameters relate early / late sound to direct sound energy measured at 1 m from the source.

Early support is the ratio of early reflections to direct sound energy, and is calculated as follows:

$$ST_{\text{early}} = 10 * \log\left(\frac{\int_0^{0,100} p^2 t dt}{\int_0^{0,020} p^2 t dt}\right)$$

The late support is the ratio of late reflections to direct sound energy, and is calculated as follows:

$$ST_{\text{late}} = 10 * \log\left(\frac{\int_0^{1,000} p^2 t dt}{\int_0^{0,010} p^2 t dt}\right)$$

$ST_{\text{late}}$  indicates the impression of reverberance and is also a measure of clarity. When  $ST_{\text{late}}$  is high, the impression of reverberance, thus the perceived feedback from the hall is high, but clarity is low. A very low  $ST_{\text{late}}$  however might indicate too little response from the surroundings, which causes musicians to feel 'detached' from the hall; a well-known problem in orchestra pits.

For both parameters a value of ca. -12 dB is considered to be good. Ueno (2004) concluded that a higher level of early support (-10 to -7 dB) is disliked by musicians, because reverberant sound is masked and the room feels small.

The ratio between early and late support indicates the degree of masking of ensemble information by loud reverberation. [Gade, 1992] This ratio is actually comparable to the  $LQ_{7-40}$  as it omits direct sound, although the time limits and the measurement procedure are different.

$$ST_{\text{late}} - ST_{\text{early}} = 10 * \log\left(\frac{\int_0^{1,000} p^2 t dt}{\int_0^{0,020} p^2 t dt}\right)$$

The integration limits of the early and late support have some practical implications:

- Any obstacles (chairs/music stands) within 2 m from the sound source are to be removed to prevent early reflections within the first 10 ms.
- Measurements should preferably be performed at a minimum distance of 4 m from any wall or ceiling to prevent early reflections from arriving before 20 ms.

As a consequence these parameters do not seem suitable for small spaces such as orchestra pits. Changing the integration limits might be a solution; an alternative parameter was proposed by Chiang and Shu (2003) and is discussed below.

### Early-to-direct energy ratio and late-to-direct energy ratio: ED80 [dB] and LD80 [dB]

The ED80 and LD80 were proposed by Chiang and Shu (2003) as an alternative to the support parameters for evaluating small performance spaces. Using both a computer and a scale model they assessed the influence of stage volume and side wall orientation on the acoustic response measured at 1 m from the source. They found the ED/LD80 to be highly correlated to the Support measures, but were not able to find proof whether either of them was better.

Even though, it was decided to include these parameters in the evaluation. Due to the incorporation of very early reflections and a narrower time frame for direct energy, these parameters might be more sensitive to alterations in the pit envelope.

ED80 and LD80 are calculated as follows:

$$ED80 = 10 * \log\left(\frac{\int_0^{0,080} p^2 t dt}{\int_0^{0,005} p^2 t dt}\right)$$

$$LD80 = 10 * \log\left(\frac{\int_0^{1,000} p^2 t dt}{\int_0^{0,080} p^2 t dt}\right)$$

*Note:* Chiang and Shu (2003) calculated the late energy from 80 ms to infinity. For this research the upper limit was chosen at 1,0 s, which was chosen by Gade as 'time to infinity'. Differences between results of both calculations are negligible.

## Overview

An overview of all parameters described in this paragraph is given in Table 4.

**Table 4: Overview of parameters**

Acoustic quantity	Subjective listener aspect	Single number frequency averaging [Hz]	Just Noticeable Difference (JND)	Typical range	Preferred value	Reference
Reverberation time, $T_{30}$ [s]	Reverberance	500 to 1000	10%			ISO 3382-1
Early Decay time, EDT [s]	Reverberance, clarity, overall acoustic impression	500 to 1000	5%			ISO 3382-1
Sound strength, $G$ [dB]	Loudness	500 to 1000	1 dB	-2; 10		ISO 3382-1
Level quotient, $LQ_{7-40}$ [dB]	Influence of architecture on stage acoustics	500 to 2000	Unknown			[Braak, van den, & Luxemburg, van, 2008]
Early strength, $G_{5-80}$ [dB]	Influence of architecture on stage acoustics	500 to 2000	Unknown		3 – 6	[Lautenbach & Vercammen, 2010]
Early support, $ST_{early}$ [dB]	Ensemble conditions	250 to 2000	Unknown	-24; -8	-12 +/- 1	ISO 3382-1
Late support, $ST_{late}$ [dB]	Perceived reverberance	250 to 2000	Unknown	-24 ; -8	-12 +/- 1	ISO 3382-1
Early-to-direct energy ratio, ED80 [dB]	Ensemble conditions	250 to 2000	Unknown		-12 +/- 1	[Chiang & Shu, 2003]
Late-to-direct energy ratio, LD80 [dB]	Perceived reverberance	250 to 2000	Unknown		-12 +/- 1	[Chiang & Shu, 2003]

## 2.1.4 REFERENCE: STAGE ACOUSTICS

Stage acoustics is a rather new field of research, and consequently the 'ideal' values for objective parameters are not known. In 2009 acoustic measurements were performed on 7 concert hall stages throughout The Netherlands by Heijnen and Kivits (2009), see Table 5. De Doelen in Rotterdam has even been measured twice; before and after the renovation during which a canopy above the stage was added. In 2010 Level Acoustics assessed different canopy positions in Casa Da Musica in Porto (Portugal). A canopy height of 8,6 m turned out to be the optimum situation for the stage acoustics.

The results of these stage measurements will be used as reference for the acoustics of the orchestra pits. Table 6 shows the values of the parameters that will be investigated in this research, averaged over all stages.

**Table 5: List of theatres**

Theatre	Year
Concertgebouw amsterdam	2009
Dr. Anton Philips Zaal	2009
De Doelen Rotterdam	2009
De Doelen Rotterdam, after renovation	2010
De Vereeniging Nijmegen	2009
Muziekcentrum Eindhoven	2009
Muziekcentrum Enschede	2009
Theater aan het Vrijthof Maastricht	2009
Casa da Musica with Canopy at 9 m height	2010

**Table 6: Average values for stage acoustics; all measurements performed on empty stages. Average values per octave band are averaged over all stages. The minimum and maximum values are highest and lowest average found over a whole stage.**

Parameter	Avg. per octave band							Min.	Max.	Avg.
	63	125	250	500	1000	2000	4000	500 - 1000 Hz		
T30 [s]	2,3	2,4	2,2	2,2	2,2	2,0	1,5	1,7	2,9	<b>2,2</b>
EDT [s]	0,9	1,5	1,7	1,8	1,8	1,7	1,1	1,5	2,3	<b>1,8</b>
G [dB]	14,1	11,8	9,7	10,7	11,1	11,2	9,4	9,5	12,0	<b>10,9</b>
LQ <sub>7-40</sub> [dB]	1.0	-3.3	-3.6	-4.7	-3.7	-3.7	-2.5	-8,2	-0,4	<b>-4,2</b>
G <sub>7-80</sub> [dB] *								1,9	5,6	<b>3,6</b>
								250 - 2000 Hz		
ST <sub>early</sub> [dB]								-15,4	-11,3	<b>-13,5</b>
ST <sub>late</sub> [dB]								-15,8	-11,8	<b>-14,4</b>

\* The G<sub>7-80</sub> is presented in **Error! Reference source not found.** because values of G<sub>5-80</sub> are unknown for the stages. The difference between the two is however likely to be negligible.

## 2.1.5 EXPECTATIONS

Some expectations regarding the results of the measurements in orchestra pits were formulated based on the results of stage acoustic measurements and the volume/materials of the orchestra pits.

### Comparison to stages

When comparing orchestra pits to stages, it is important to take into account that concert halls and opera halls generally have different acoustic characteristics. In concert halls the reverberation time is usually higher than in opera halls, where 1,6 s is advised.

- The reverberation time in orchestra pits will therefore generally be shorter than on concert hall stages, simply because the reverberation time in the hall is shorter.

- Due to the relatively small volume of orchestra pits the amount of early reflections will be relatively large compared to late reflections. The early support is therefore expected to be high, while the late support is likely to be low (unless the pit is highly reverberant).
- Consequently the  $LQ_{7-40}$  and  $G_{5-80}$  are also expected to be higher when compared to the acoustics on stage.

### Relation orchestra pit to auditorium hall: 'coupling'

Another important aspect is a phenomenon called 'coupling'; the orchestra pit acts as a coupled space to the auditorium. The orchestra pit might for example have a shorter reverberation time than the auditorium hall, but because the spaces are coupled the pit will also receive an amount of late reflections from the hall. The result is a double slope decay curve (see Figure 15) with the first part relating to the pit acoustics, and the second to the auditorium hall.

When this occurs, the EDT - which is related to the first part of the decay curve - will be much shorter than the reverberation time. In the pit of De Vest (VES) for example much sound absorption and consequently a short EDT is to be expected.

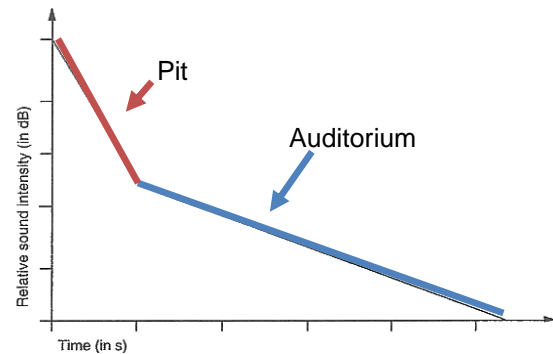


Figure 15: Simplified double slope decay curve [based on Feilding, 2010]

### Open vs. covered part of the orchestra pit

A difference is expected between the open and covered part of the pits.

- At the open part the influence of the auditorium hall will be more apparent, resulting in a longer reverberation time and possibly a longer EDT than in the covered part.
- The proximity of walls and ceiling in the orchestra pit will cause many strong reflections, resulting in a high strength ( $G$ ), especially at the covered part of the pit.

## 2.2 MAIN RESULTS AND ANALYSIS

The measurement results have been analyzed in the following order:

- Single number averages
- Octave bands averages
- By position and by distance source - receiver

Table 7 shows for each theatre the date of measurement and the average temperature and relative humidity during the measurements.

**Table 7: Dates and climatic conditions during measurements**

Pit	Date	Temperature	Relative humidity	Remarks
VES	12 Aug 2010	Not measured	Not measured	
PAR	31 Aug 2010	21,5 °C	46%	Fire screen down
MZT	10 Sep 2010	24,3 °C	53,2%	Fire screen down
STS	30 Sep 2010	22,9 °C	43,2%	

All results are averaged over the 500 and 1000 Hz octave bands, unless indicated otherwise.

### 2.2.1 COMPARISON BASED ON AVERAGE VALUES

A total of four average values were calculated for each pit, see Figure 16:

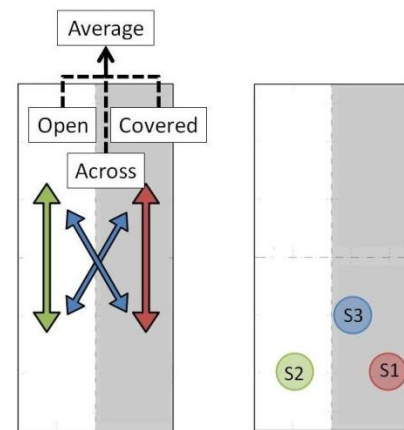
- Avg. open: S2 to R4, R6 and Rc
- Avg. covered: S1 and S3 to R1/3, R5 and R7
- Avg. across: S2 to R1/3/5/7 and S1/3 to R2/4/6/c
- Avg. pit: The average of open, covered and across.

The results of early and late support, ED80 and LD80 were derived from measurements at 1 m from the sound source at three positions in each pit, see also Figure 16.

The results are discussed and compared to the acoustic situation on stage and in the auditorium hall, and to the acoustic properties of concert hall stages.

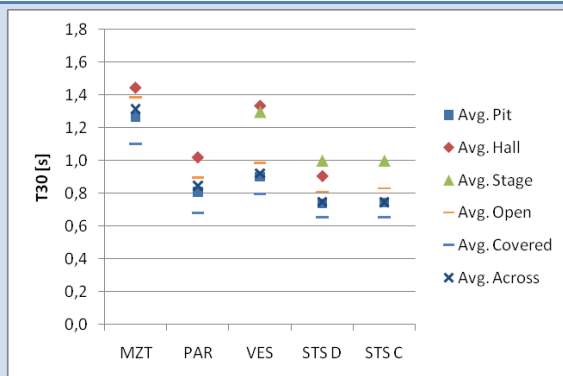
#### Reverberation time: $T_{30}$ and EDT

Figure 17 shows the reverberation time ( $T_{30}$ ) and Early Decay Time (EDT) of the measured pits versus the hall and stage. Unfortunately there are no data for the stage at MZT and PAR, due to the fire screen being closed during measurements. The data for hall and stage were derived from measurements with the source in the pit and receiver(s) at the seating area / stage.

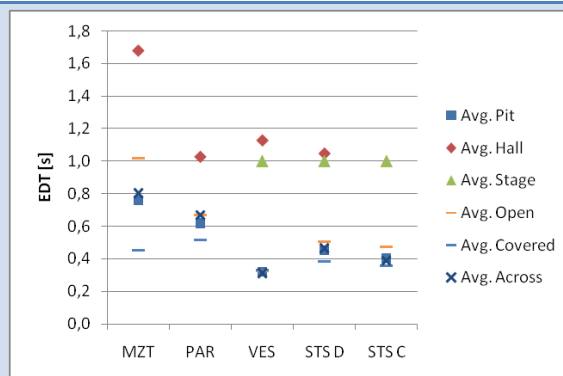


**Figure 16: Analysis of open, covered and across transmissions (left); analysis of support, ED80 and LD80 at three positions (right)**

$T_{30}$  [s]



EDT [s]



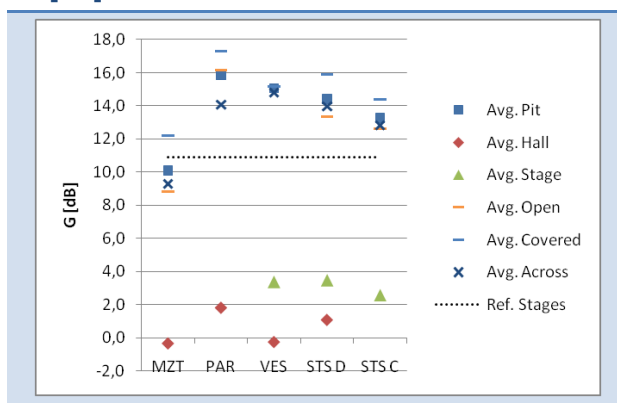
**Figure 17: Comparison pit to hall and stage, reverberation time**

The reverberation time in the pits is generally about 0,2 s shorter than in the auditorium hall and on stage. The orchestra pit of theatre De Vest (VES) forms an exception here; the  $T_{30}$  measured in the pit is 0,4 s shorter than in the hall. Furthermore, a spread of 0,2 – 0,3 s can be found between the open and covered part of the pits, which is much higher than the JND (5%).

A much larger difference exists between the early decay time (EDT) in the pit and hall/stage, ranging from 0,4 (PAR) to 1,0 s (MZT). Besides the fact that the EDT in the Muziektheater (MZT) is much shorter than the  $T_{30}$ , the difference between open and covered part is remarkably high: ca. 0,55 s. All other orchestra pits show a trend to the contrary with the difference between open and covered part being smaller for EDT than for  $T_{30}$ . The latter can be explained by the fact that the first part of the decay curve, both in open and covered part, is likely to resemble the decay curve of the pit volume – not the hall, which results in similar values for EDT.

## Sound strength: G

### G [dB]



**Figure 18: Comparison pit to hall and stage, strength**

Although loudness is one of the main complaints in the MZT pit, the average sound strength was measured to be the lowest of the four pits and comparable to a situation on stage. Also, the difference between sound strength in the hall and the pit is the smallest for MZT, and largest for VES. One has to be careful drawing conclusions from these numbers, because the positions in the auditorium hall were chosen quite randomly, i.e. not at same distances from the pit. The differences between the pits can partially be explained by their dimensions; the MZT is de

largest pit, therefore the measured strength is the lowest. However, PAR, VES and STS show about the same values for strength, while their dimensions range from 47 m<sup>2</sup> to 142 m<sup>2</sup>. An analysis of the strength at different positions versus their distance to the source is presented in § 2.2.4.

Finally it is remarkable that 'avg. open' and 'avg. covered' are 2 to 3 dB higher than 'avg. across' in the pit of the Parade (PAR). Apparently sound energy is lost when it is transmitted from covered to open part and vice versa, see § 2.2.3 for a further analysis.

## Support and ED/LD80

Figure 19 displays the early and late support and the ED80 and LD80 at three positions in all pits.

Nearly all values of early support are above -10 dB, which is considered to be unpleasant according to Ueno (2004). The early support is closest to the desired value in the open parts of the pits, especially in MZT and STS-C. In VES the difference between different positions is small, but in MZT and PAR a difference up to 6 dB is found. The fact that  $ST_{early}$  is higher in the pits than on stage is likely to be caused by a larger amount of early reflections.

The late support - or perceived reverberance - is very low in the pits, which might have been expected, because the EDT is also low / short. MZT and PAR have the longest early decay time and also the highest late support. The values found for PAR are remarkably close to the desired values, with  $ST_{late}$  ranging between -12 and -14 dB. Furthermore the spread between different source positions is much lower for  $ST_{late}$  than for  $ST_{early}$ .

As the ratio between early and late support is said to indicate the degree of masking ensemble information (§ 2.1.3), the large difference between the two would indicate high masking - especially in the covered part of the pits. The ED80 is on average 4,5 dB higher than  $ST_{early}$ , while LD80 is on average 2,7 dB higher and consequently the difference between the two is even larger than for  $ST_{early}$  and  $ST_{late}$ . This result indicates that indeed many early reflections are lost in the calculation of early support. The differences between the pits are smaller for ED80 than for  $ST_{early}$  at positions S1 and S3, but larger at S2. The results of LD80 are quite similar to those of  $ST_{late}$ .



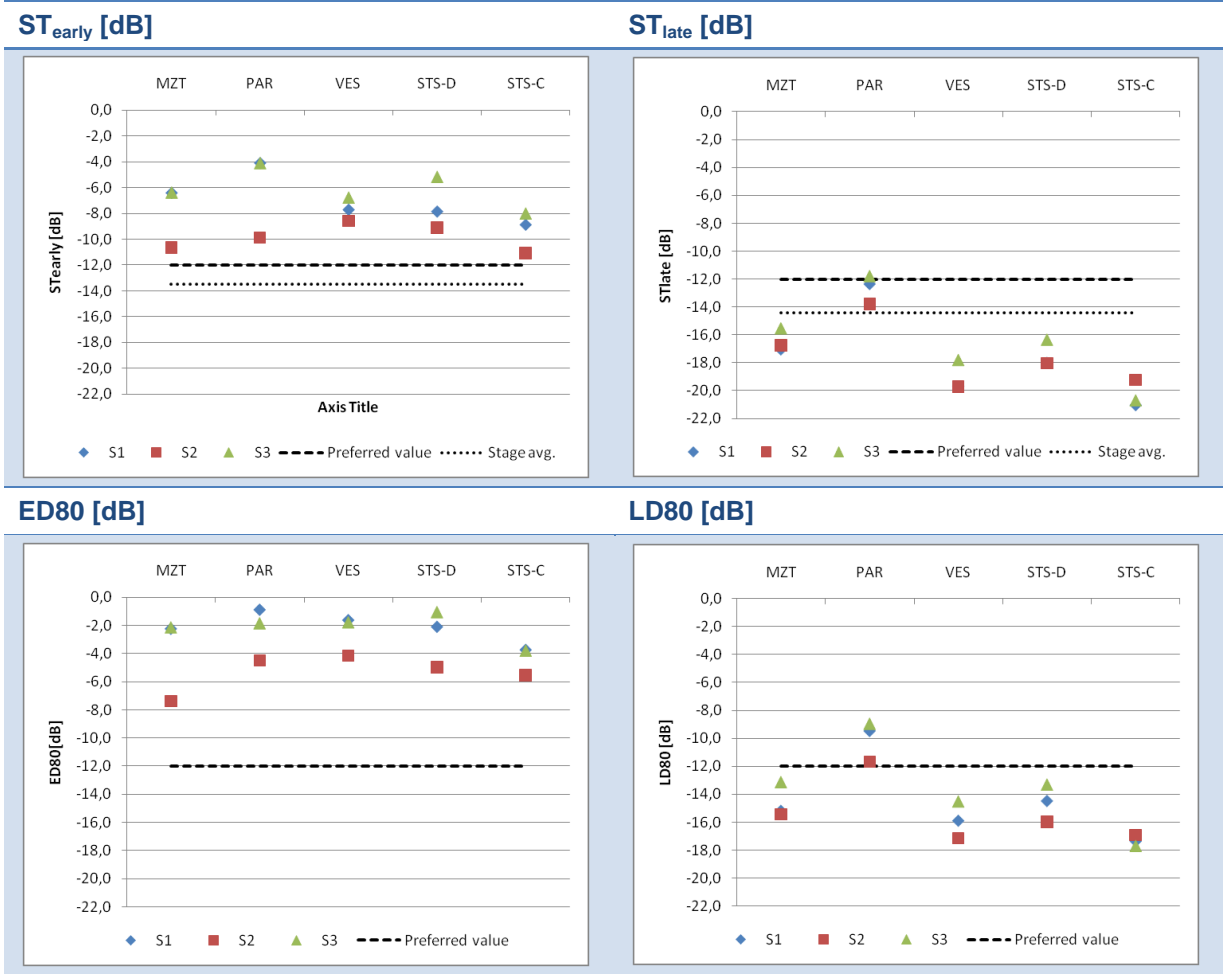


Figure 19: Support and ED/LD80, averaged 250-2000 Hz

**Level quotient and early sound strength:  $LQ_{7-40}$  and  $G_{5-80}$**

The chart in Figure 20 representing  $G_{5-80}$  is hardly different from the chart representing  $G$ , although the values are approximately 2 dB lower. This result suggests that the strength  $G$  measured in the pits is largely determined by early reflections.

The  $LQ_{7-40}$  does not seem to be related to the  $G_{5-80}$ . Furthermore the  $LQ_{7-40}$  is generally much higher in the pits than on stages, and the difference between open and covered part ranges from nearly zero (STS-D) to nearly 9 dB (VES), see also § 2.2.3. Furthermore the  $LQ_{7-40}$  is the lowest in the open part of the pits, except for PAR. The ‘across’ values are generally close to ‘avg. open’ for  $G_{5-80}$ , while closer to ‘avg. covered’ for  $LQ_{7-40}$ .

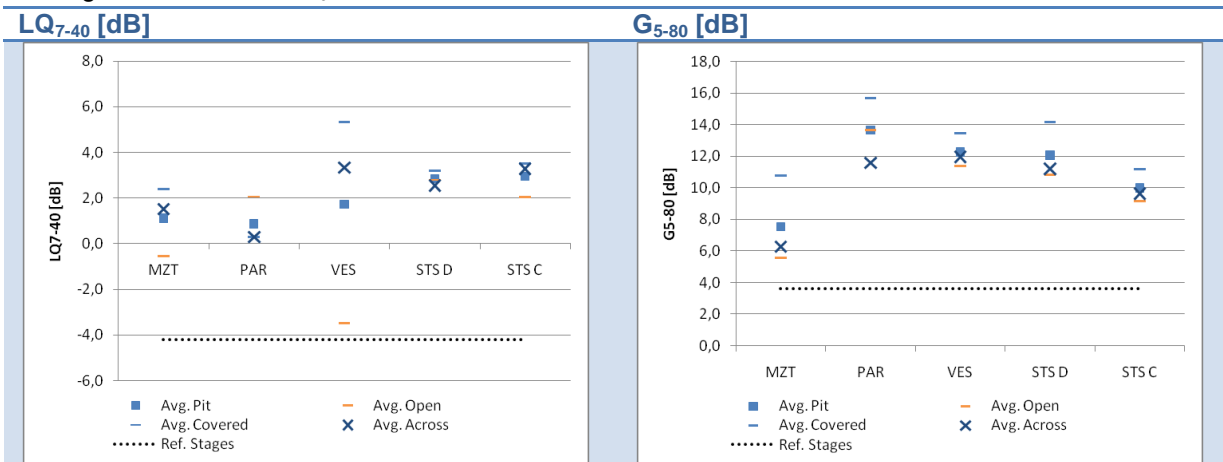


Figure 20:  $LQ_{7-40}$  and  $G_{5-80}$ , averaged 500-2000 Hz

## 2.2.2 ANALYSIS BY OCTAVE BANDS

### Reverberation time, hall versus pit

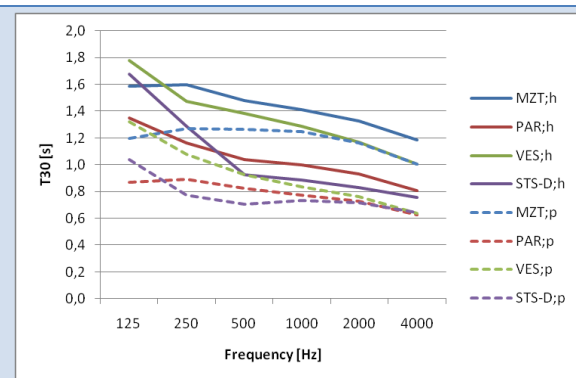
In Figure 21 the  $T_{30}$  and EDT measured in the hall and in the pit are compared. The 63 Hz octave band is not included in the charts because the INR measured in the halls is too low at this frequency. Furthermore STS-C is not included because no measurements in the hall were performed with the curtains closed.

The shape of the  $T_{30}$  curve of hall and pit do seem to relate, with the  $T_{30}$  in the pit being 0,2 – 0,4 s shorter. The EDT in the pit is however is up to 1,0 s shorter than in the hall.

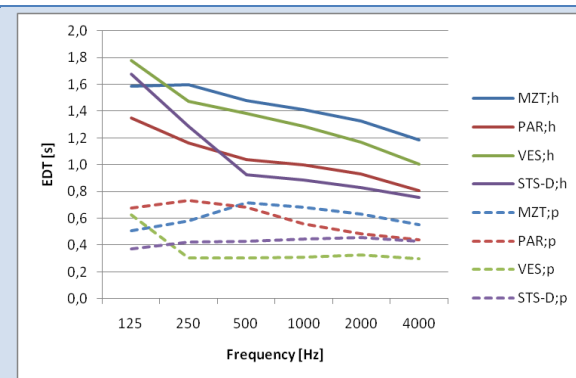
The two charts below show the relation between  $T_{30}$  and EDT in both hall and pit. When  $T_{30}$  and EDT are equal, a room is said to be completely sound diffuse. This seems to be the case in the hall of the Parade (PAR). All other theatres show a difference up to 0,2 s. However, in the orchestra pits the difference is much larger; up to 0,7 s. The difference is the smallest for PAR and largest for MZT and VES.

While most theatres show the highest reverberance at low frequencies, the MZT shows a peak at 500 Hz and shorter reverberance at low and high frequencies. Generally a slightly longer  $T_{30}$  at low frequencies is preferred (max. 20% longer), because the human ear is less sensitive to those frequencies. The situation at MZT is therefore not ideal. Perhaps the elevated floor of the MZT pit (wooden panels on air) acts as a large LF-absorber.

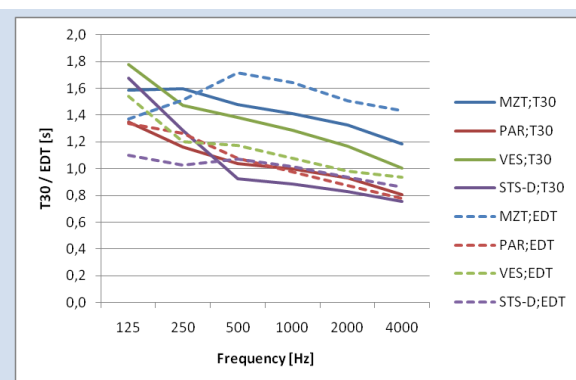
**$T_{30}$  – hall vs. pit**



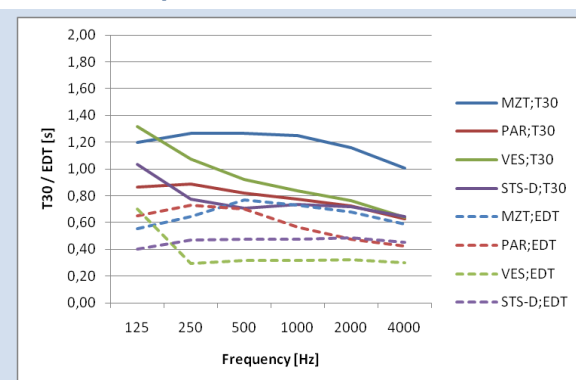
**EDT – hall vs. pit**



**$T_{30}$  vs. EDT hall**



**$T_{30}$  vs. EDT pit**



**Figure 21: Comparison pit and hall –  $T_{30}$  and EDT**

## EDT and G, open versus covered

Zooming in on the pits themselves, Figure 22 displays two graphs showing the difference between open and covered part of the pits for EDT and strength. Notably the EDT is quite long at low frequencies and very short at mid and high frequencies in the pit of De Vest (VES). For the latter frequencies there is no difference between open and covered part. Perhaps the storage areas in the back and front of this pit absorb mainly mid and high frequencies.

The difference in strength between open and covered part of the pits seems to increase with frequency, except in VES. At Het Muziektheater (MZT) the largest differences were found, up to 5 dB.

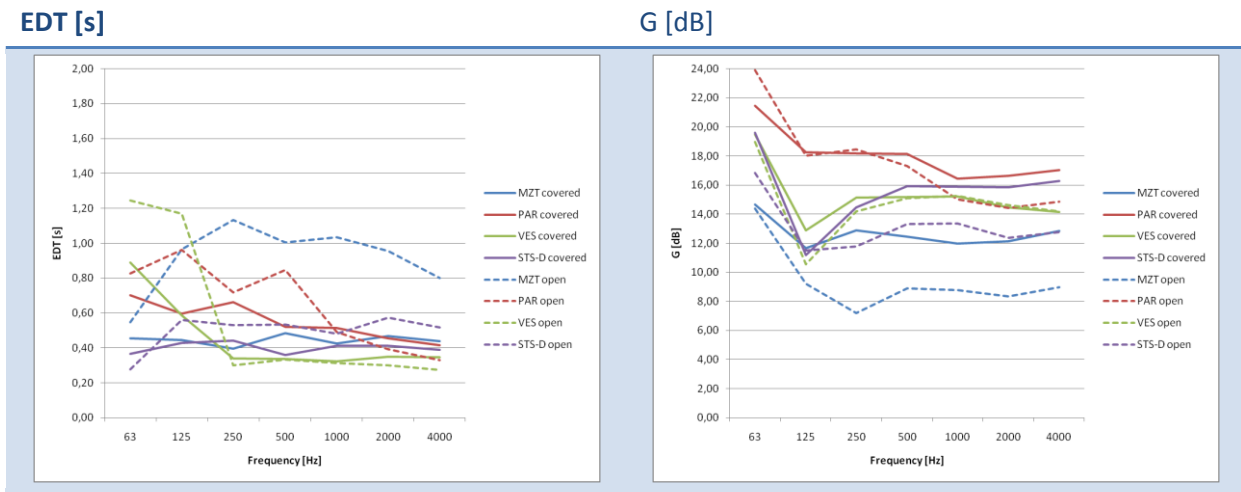


Figure 22: EDT and G at covered (solid line) and open parts (dotted line) of all pits

## 2.2.3 ANALYSIS BY RECEIVER POSITION

Up to now only averaged values for the whole pit or by source position have been presented. For a more thorough understanding of the pit acoustics however, it is interesting to look at the differences between receiver positions. For a clear understanding of what happens in the back (covered part) of the pit compared to the front, values are presented by receiver position according to Figure 23.

To calculate the average for each receiver position, all source positions were included in the calculations:

- Avg. open: S1-S3 to R6, Rc, R4 and R2
- Avg. covered: S1-S3 to R7, R5, R3 and R1

Finally the influence of different source positions on sound transmission to each receiver position was analyzed as well. The most interesting results will be discussed in this paragraph.

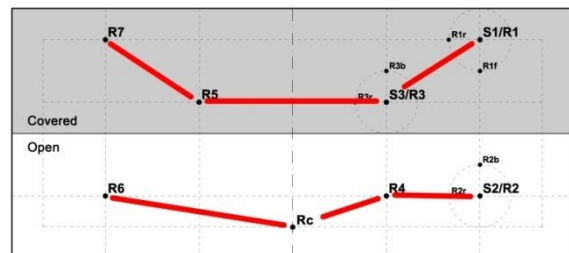


Figure 23: Receiver positions.

## Early Decay Time: EDT

The EDT was found to be quite long in the open part of the MZT pit. Figure 24 displays three charts showing the EDT by receiver position. In the chart on the left the open and covered part are compared (red and green line respectively), and on the right the influence of different source positions on the EDT are further clarified. Clearly, when sound produced in the open part (S2, orange line) is transmitted over a long distance the EDT is significantly higher. Evidently the direct sound energy has a stronger influence at short distances (causing a short EDT), while at larger distances the reverberation of the pit/hall is prevailing.

## MZT

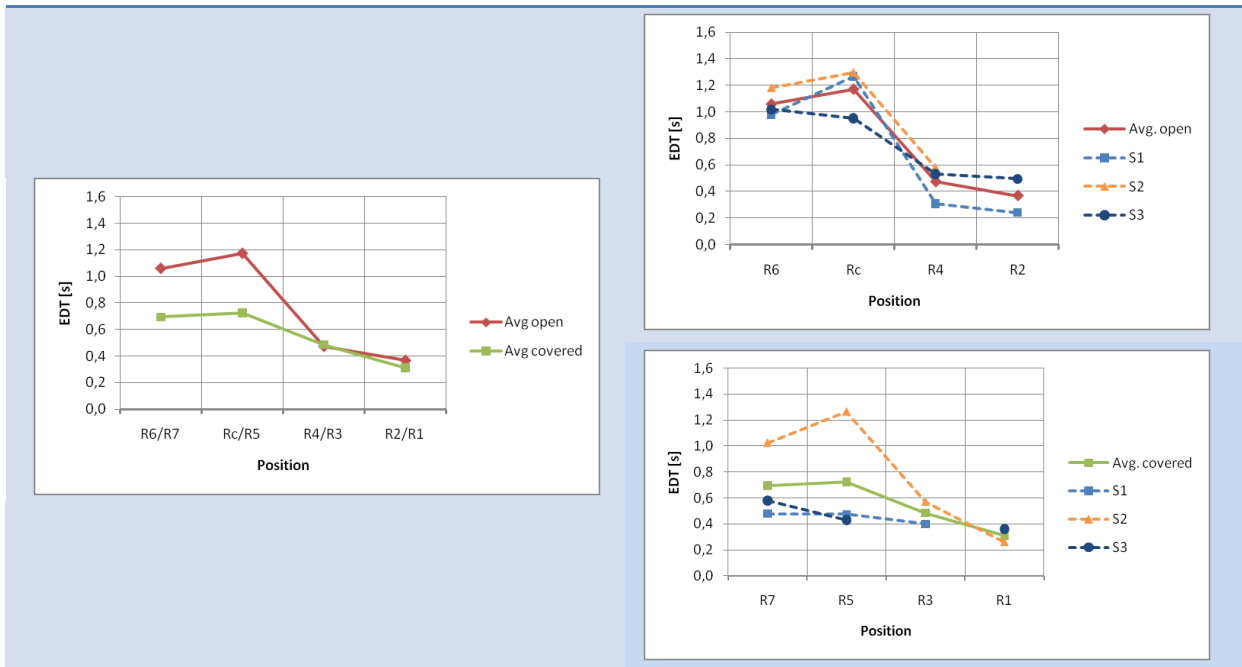


Figure 24: EDT at MZT, analysis by position

### Sound strength: G

The sound strength was found to be approximately 2 dB higher at the covered part of most orchestra pits. In the pit of De Vest (VES) the sound strength is quite uniform throughout the pit. In all other pits sound transmission from open to covered part causes a significantly lower strength than within the covered part. This result suggests that musicians positioned underneath the stage do not hear sound from the open part well, which hinders ensemble playing.

## PAR

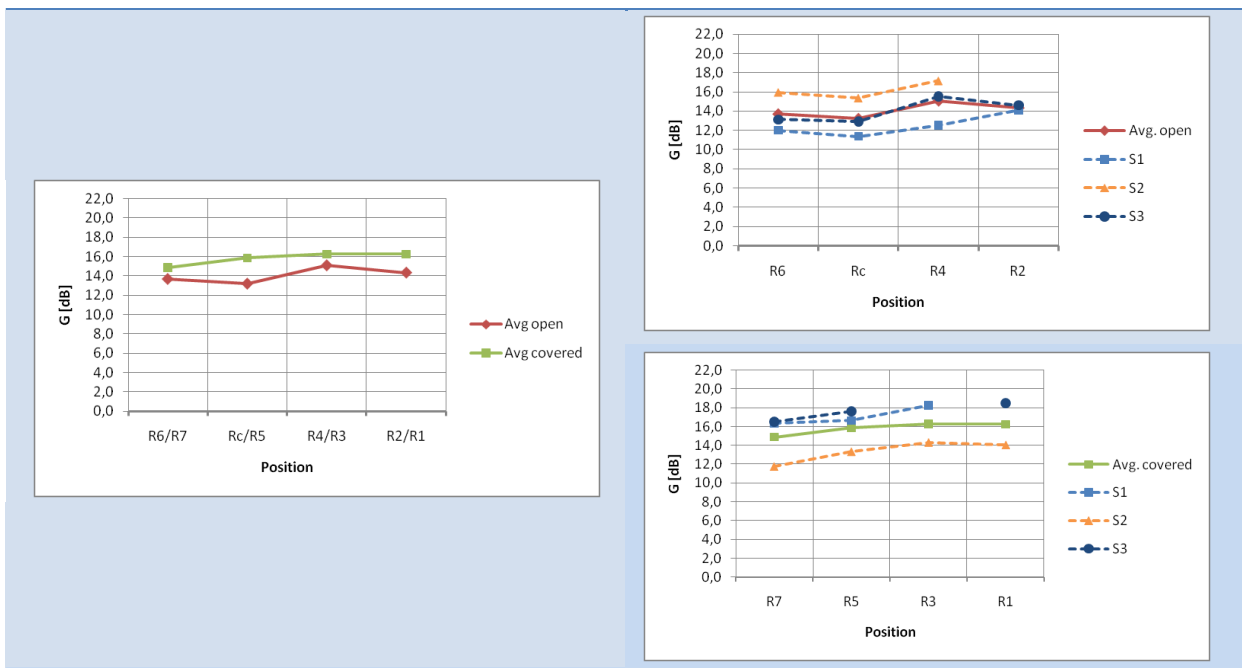


Figure 25: Strength at PAR, analysis by position.

At the orchestra pit of Theater aan de Parade (PAR) the 'across' transmission was found to produce significantly lower values of G than transmission in the open and covered part, (see §2.2.1). This

phenomenon is clarified with the help of the charts in Figure 25. Especially transmission from S1 to receivers at the open part and transmission from S2 to receivers in the covered part cause a low level of G.

**Level quotient:  $LQ_{7-40}$**

When analyzing the single number averages a very large difference was found between open and covered part of VES, while it was nearly zero at STS-D. Figure 26 shows how different source positions are responsible for these differences.

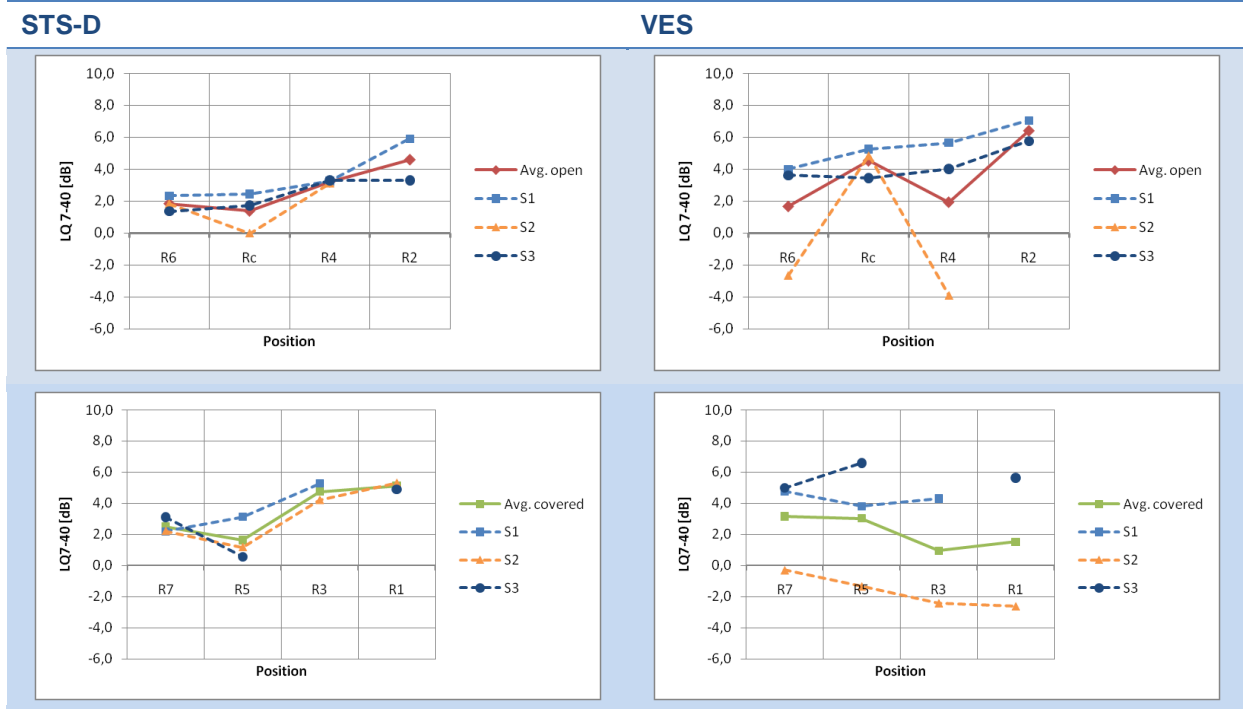


Figure 26:  $LQ_{7-40}$  at STS-D and VES, analysis by position, averaged 500-2000 Hz

**2.2.4 INFLUENCE OF SOURCE-RECEIVER DISTANCE**

For some parameters there is a clear relation between the distance to the sound source and its value. The reverberation time ( $T_{30}$ ) is quite uniform throughout the pits, but the EDT generally increases with distance due to a reduced influence of direct sound. The  $LQ_{7-40}$  seems to decrease with distance, but the spread is very large, making it difficult to find a reliable trend.

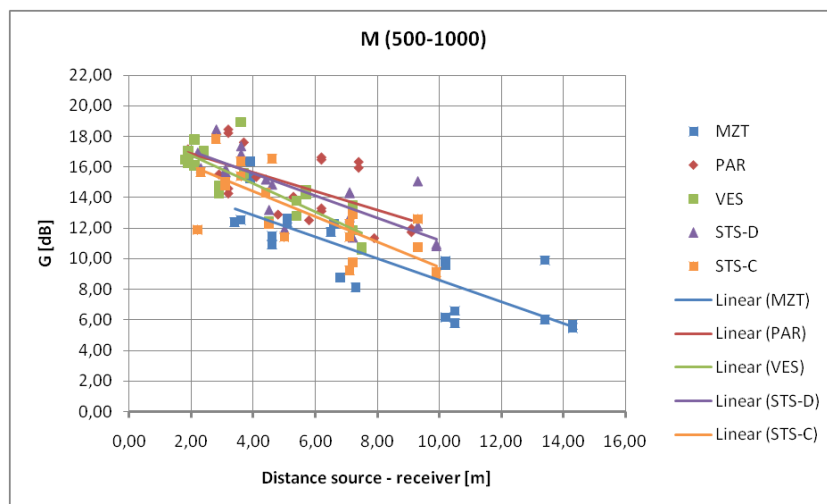


Figure 27: Relation between distance source-receiver and strength

Another clear relation is found for the sound strength (G), which decreases as the distance to the source increases, see Figure 27. The same goes for  $G_{5-80}$ . Looking at this figure it is more easily understood why the average strength in Het Muziektheater (MZT) is much lower than in the other pits; the distances are simply larger.

## 2.2.5 DIFFUSERS VERSUS CURTAINS

As was mentioned earlier, two setups were measured in the Stadsschouwburg (STS): with diffusers at the rear wall and with a thick curtain covering the rear wall (see § 2.1.1). To assess the influence of these different measures on the acoustic conditions in the pit, the results were thoroughly compared. In this paragraph the results of this comparison are summarized, and the most remarkable differences are presented.

The first measurements were performed with diffusers at the rear wall. These were covered by thick curtains for the second measurement series. When the curtains are closed: (see Figure 28 for graphs)

- the reverberation time ( $T_{30}$ ) does not change;
- the EDT decreases by ca. 0,1 s in the open part, except at the conductor's position (Rc) where the difference is negligible.
- the EDT decreases only slightly in the covered part of the pit, with the biggest reduction at R5 (0,1 s). Remarkably the EDT increases at R7;
- the  $LQ_{7-40}$  generally increases unexpectedly, suggesting a higher density of very early energy. Apparently the curtains cause a bigger reduction in 'late early' (40-80 ms) and late reflections, than in very early reflections. At R3 and R4 the differences are negligible, but at R5 the increase is significant: nearly 2 dB. An exception is found at R7, where the  $LQ_{7-40}$  is decreased by appliance of curtains;
- $G_{5-80}$  shows reductions ranging from 2 to 3 dB in the covered part. Closer to the source the reductions in the open part are significant as well; nearly 2 dB at R4 and R2;
- the strength G is reduced as well, but no more than 1 dB, except at positions R4 and R7 with a reduction of 2 and 3 dB respectively.

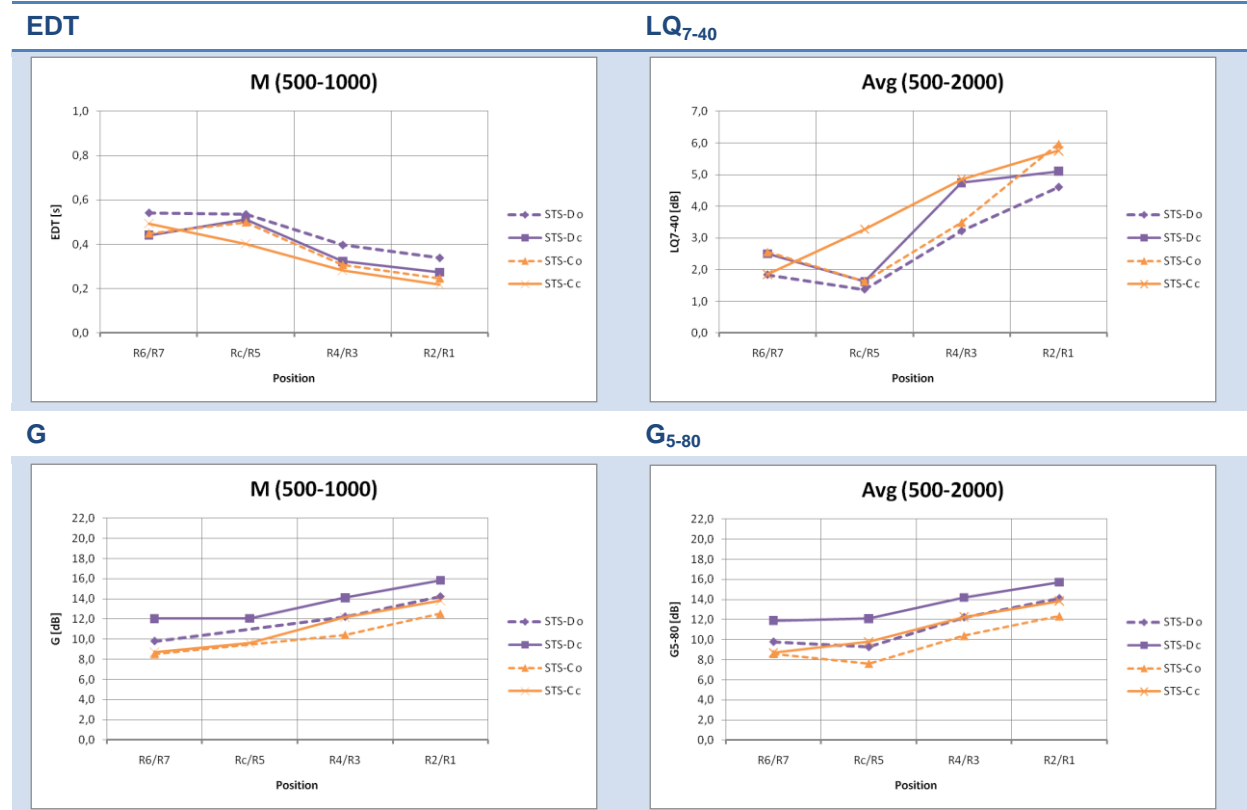


Figure 28: Comparison STS-D and STS-C, analysis by position. 'O' is open, 'c' is covered.

For all parameters the influence of different source positions on transmission to the receiver positions was assessed as well. The most remarkable result was found when looking at the  $LQ_{7-40}$ , see Figure 29. At the covered part not much seems to change whether diffusers or curtains are applied, except for transmission between S3 and R5. There is however a striking difference at the open part of the pit; with the curtain closed the spread increases dramatically. The diffusers cause transmission from different source to receiver positions to be more uniform / balanced. The fact that this large difference is only found in the open part is likely to be caused by the fact that Schroeder diffusers are designed for the far field rather than the near field. [Cox & D'Antonio, 2004, p. 267]

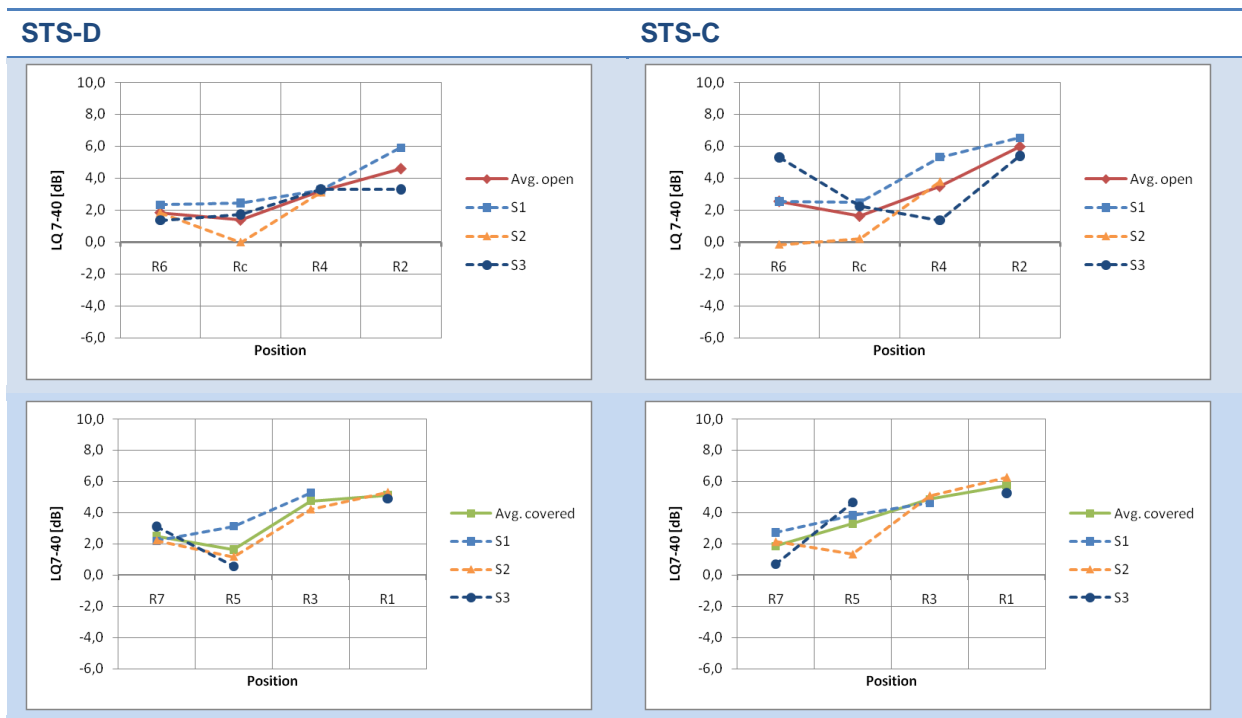


Figure 29: Comparison STS-D and STS-C, analysis by source and receiver position, averaged 500-2000 Hz

## 2.3 EVALUATION AND GOALS FOR MEASUREMENTS IN SCALE MODEL

The results of measurements in four Dutch orchestra pits were assessed and compared to each other and to acoustics on stage. The most important and most remarkable results are evaluated here, based on which goals for the scale model assessment of the orchestra pit of Het Muziektheater (MZT) are formulated. See Appendix II for a quick overview of the measurement results.

### Acoustic characteristics of orchestra pits – general findings

In the previous paragraph some expectations were formulated regarding the acoustic characteristics of orchestra pits. Most of those expectations were confirmed by the measurement results:

- Generally there is a high amount of early sound energy relative to late sound energy. This becomes apparent when comparing the acoustics in the pits to those on concert hall stages: both  $LQ_{7-40}$  (early to late energy ratio) and  $ST_{early}$  (early to direct energy ratio) are ca. 6 dB higher in the pits.
- Although the sound strength (G) in the pits is on average 'only' 3 dB higher than on the concert hall stages – which is in line with the results found by Peutz (2003) - the early sound strength ( $G_{5-80}$ ) is 7 dB higher than on the stages. This implies that most of the sound strength is concentrated in early sound.
- A short Early Decay Time (ca. 0,5 s) and a low late support (ca. -17 dB) indicate that the experienced reverberation time is very short in the pits.
- The acoustic discomfort musicians experience when playing in orchestra pits is likely to be caused by a relatively high amount of early reflections and simultaneously a low amount of late reflections.

### Acoustic characteristics of a 'bad' orchestra pit: De Vest, Alkmaar (VES)

The orchestra pit of De Vest (VES) is known to have bad acoustic properties. During the analysis of the results an attempt was made to determine which parameter(s) best represent the 'bad' properties of this pit:

- The most remarkable difference with all other pits was found when assessing the  $LQ_{7-40}$ ; the difference between the open and covered part was nearly 9 dB. This result implies a very irregular distribution of early reflections, which has a negative effect on the ensemble conditions. A possible explanation for this large spread is a generally low amount of early reflections caused by large areas of sound absorbing materials (chairs in the back and storage in the front), due to which value of  $LQ_{7-40}$  becomes highly dependent of the amount of late reflections.
- These sound absorbing areas also cause the EDT to be the lowest of all pits, except at low frequencies, which might be disturbing to the musicians.
- In contrast with the results found for  $LQ_{7-40}$  all other parameters show a rather uniform distribution throughout the pit.
- Finally the pit in De Vest is very small and looks more like a storage area than a performance space. Although these are esthetic aspects they undoubtedly influence the musicians' experience.

Based on these results a uniform distribution of the early to late energy ratio ( $LQ_{7-40}$ ) throughout the pit seems to be a favorable condition.

### Effect of acoustic measures at the rear wall of orchestra pits: diffusers vs. curtains

In the Stadsschouwburg, Eindhoven (STS) the influence of both diffusers and a heavy curtain at the rear wall were assessed. This was an interesting opportunity, because these same measures are to be experimented with in the scale model. The following differences between the two measures were found:

- The appliance of curtains causes the sound strength to decrease, especially the early strength  $G_{5-80}$  (-2 dB).



- Both the early and late support are decreased by appliance of curtains (-2 and -3 dB respectively).
- The EDT decreases as well when curtains are applied.
- Surprisingly the  $LQ_{7-40}$  is increased by appliance of curtains. A closer look at the results however revealed that the distribution of early reflections was much more uniform with diffusers present. This effect was best visible in the open part of the pit, which means that musicians sitting close to the rear wall do not fully experience their influence .

### **Acoustics of the pit in Het Muziektheater, Amsterdam (MZT)**

The main acoustic characteristics of this pit, and the acoustic properties which makes it stand out from other pits, are summed up here:

- The differences between open and covered part of this pit are relatively large for nearly all parameters considered.
- MZT was the only pit where a significantly different EDT was found in the open part of the pit at longer distances from the source. Supposedly the opening to the hall is so large in this pit, that it reverberates as part of the auditorium hall, rather than as a coupled space. Furthermore the reverberation time in the hall of MZT is the longest of all theatres considered, which also contributes to a longer EDT.
- Another aspect that makes MZT different from other pits is its low reverberation time at low frequencies. This is disadvantageous because the human ear is less sensitive to those frequencies, which is why typically a slightly longer reverberation time is required. Possibly the elevated wooden floor acts as a large LF-absorber.
- Although excessive sound levels were one of the main complaints in the MZT pit, the sound strength measured in this pit was by far the lowest, and nearly equal to the average found on concert hall stages. Sound strength is however a relative value; when a large symphony orchestra is placed in this pit the sound levels can still be excessive. Furthermore the type of instruments and their location within the pit highly influence the sound level.
- Similar to the other pits the early sound strength  $G_{5-80}$  is significantly higher than on concert hall stages, as is the  $LQ_{7-40}$  and  $ST_{early}$ .

### **Relevance of measurements in an empty orchestra pit**

Drawing conclusions from measurements in an empty orchestra pit is as difficult as drawing conclusions from measurements on an empty stage. The presence of an orchestra undoubtedly has considerable influence on the sound field within the orchestra pit. Dammerud (2009) studied sound transmission through an orchestra on stages based on theoretic analyses and scale model measurements. He found that direct sound is largely attenuated at distances  $> 6$  m from the source. Frequencies below 250 Hz are freely transmitted through the orchestra, but at higher frequencies the orchestra has a considerable influence. Furthermore due to interference effects certain frequencies can be either muffled or amplified at certain distances relating to their wavelengths. Especially the early acoustic response, which is important for ensemble conditions, is highly affected by the presence of an orchestra. Dammerud, et al. (2010) even state that: "*The results from the three year project covered in this paper suggest that existing acoustic measures based on omnidirectional acoustic responses on stage without the orchestra present have very limited physical validity and subjective relevance.*" At the same time this statement underlines the necessity for further research, experiments with alternative measurement methods and other parameters.

### **Goals for measurements in scale model**

Despite many uncertainties a study of trends when applying different measures in the orchestra pit of Het Muziektheater is expected to be valuable. The main goal of the measurements in the scale model is to study the influence of diffusers, absorbers and a different floor height on the acoustic properties of the pit. Based on the measurement results presented in this chapter the new parameter  $LQ_{7-40}$  seems to be relevant. Furthermore a better balance of early and late reflections throughout the pit seems to be favorable.

### 3 ASSESSMENT OF A 1:10 SCALE MODEL OF THE ORCHESTRA PIT IN HET MUZIEKTHEATER

#### 3.1 PRELIMINARY INVESTIGATIONS

##### 3.1.1 BUILDING THE MODEL

###### Material use

The scale model would ideally be built with materials with the same acoustic properties at scale 1:10 (so at 10x normal frequencies) as the materials in the full scale orchestra pit. However, to achieve such realistic scaling thorough research of possible materials would be necessary. Therefore acoustic scale models are typically built with MDF, because this material is uniform, smooth and easy to process.

However, MDF is also quite heavy ( $750 \text{ kg/m}^3$ ), and the scale model of the orchestra pit of the MZT will be rather big with dimensions of approximately  $2,6 \text{ m} \times 1,2 \text{ m} \times 0,4 \text{ m}$ . To limit the weight of this model it was investigated whether XPS (Styrodur) could function as a substitute for MDF. The absorption properties of both materials were measured and compared, see Appendix IV for an elaborate description of this material assessment.

The absorption coefficient ( $\alpha$ ) of XPS was found to be ca. 0,2, while the absorption coefficient of MDF is ca. 0,1. Based on these results it was decided to build the model entirely with MDF, and not with a combination of materials. That way the acoustic properties of the scale model might not exactly match those of the full scale pit, but at least they are uniform and known. Figure 30 shows the absorption properties of MDF compared to those of some common materials in the orchestra pit of Het Muziektheater.

Pictures of the scale model and of the real orchestra pit are displayed in Figure 31. The model was built within a wooden frame work for stability. The stage floor is removable for easy access into the model, and the floor can be placed in two positions: high and low. The high position matches the most commonly used layout in Het Muziektheater, and the low position matches the situation when the elevated wooden floor would be removed (-40 cm at scale 1:1).

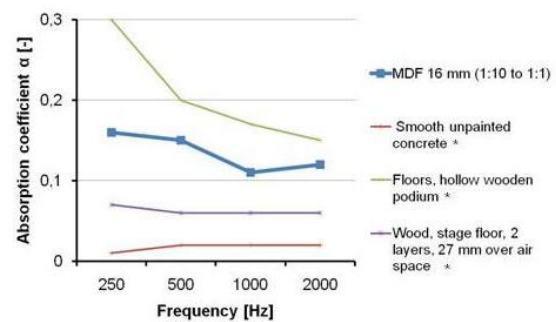


Figure 30: Comparison  $\alpha$  of MDF to some common materials in the orchestra pit. \*[Odeon 10.1, 2009]

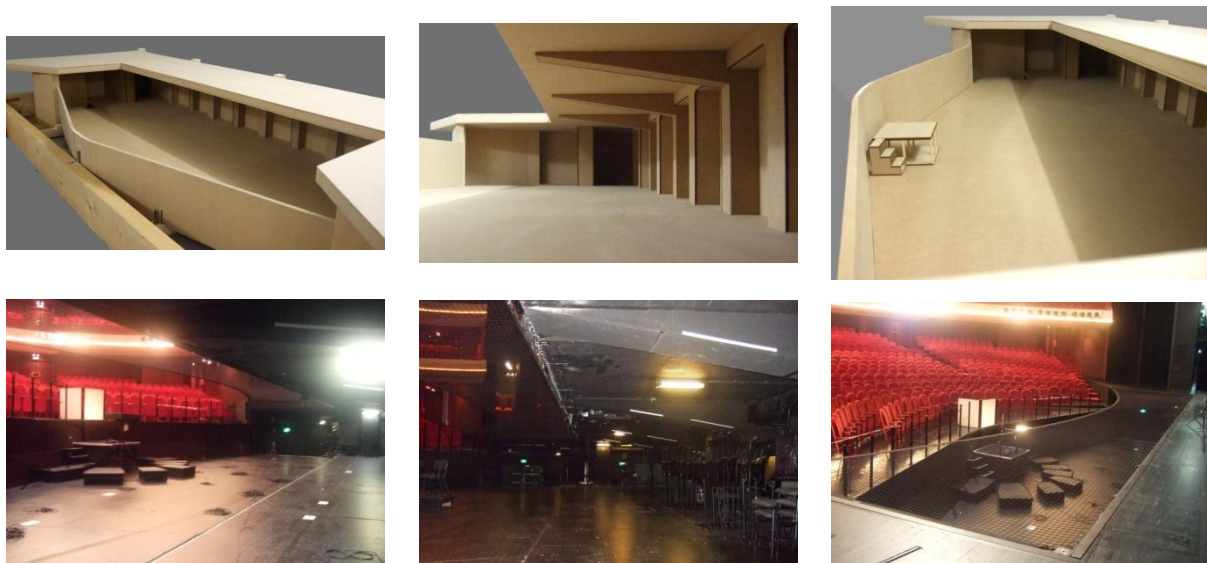


Figure 31: Pictures of the scale model (top) and of the real orchestra pit (bottom)

### 3.1.2 MEASUREMENT METHOD

#### Equipment

Measurements were performed using a so-called 'spark gap' which produces a 'spark train' (see boxed text for a definition), the sound was recorded by a small microphone which is sensitive to high frequencies and processed with software Dirac 4.1 and Dirac 5.0 Beta. With this software impulse responses can be scaled and corrected for air attenuation effects. See Table 8 for the details of all equipment.

Table 8: Overview of equipment

Source	Spark gap
Microphone	
Software	Dirac 4.1 and 5.0 Beta
Laptop	
Dsfe	
Feew	

#### Spark gap

"A spark gap consists of two electrodes ... at a fixed distance to which a high voltage is applied. When the electrical field strength becomes sufficiently large, a breakdown of the air results in an electrical discharge. ... this coincides with a bang and a flash of light."

#### Spark train

"A 'spark train' is defined as a rapid succession of discharges with more or less fixed intervals. This can for instance be achieved by switching electronically the primary winding of a step-up transformer."

[Hak & Bijsterbosch, 2009]

#### Development of the measurement method

The spark gap and the microphone were positioned at 13,5 and 12,0 cm above the floor to match the situation in the real pit, see Figure 32. The spark gap was developed by Hak and Bijsterbosch (2009), who also performed some first tests regarding the sound power produced by this spark gap and its stability. To validate their results some of those tests were repeated, and some additional tests were performed:

- The directivity of the source was investigated;
- and possibilities to determine the sound strength 'G' in the scale model were explored.

Based on the results of those investigations the measurement method for the scale model was determined, see Appendix V for a full account of those investigations.

The spark gap was found to be omnidirectional in the horizontal plane. For the sake of repeatability it was decided to point the spark gap towards the rear wall of the orchestra pit during all measurements.

The frequency range that can be assessed is limited by the INR at the low end and by unstable results at the high end, see Appendix V. It was therefore decided to assess only the frequencies within the range of 250 – 2000 Hz. To achieve an INR  $\geq 35$  dB at 250 – 2000 Hz a minimum of 8 measurements is necessary at each position. Furthermore to determine the strength of the spark with sufficient accuracy a minimum of 10 sparks is desirable. Due to occasional instability of the sparks it was decided to perform 15 measurements at each position, to allow a maximum of 5 files to be deleted afterwards.

To determine the sound strength 'G' in the scale model a system calibration is usually performed. After investigating different methods it was decided to calculate the sound strength based on a reference measurement at 1 m from the source in the scale model. For this purpose transmissions S2R2r and S2R2b were used. With 10 to 15 measurements the sound strength can be determined with an accuracy of 0,6 to 0,7 dB over a 95 % confidence interval.

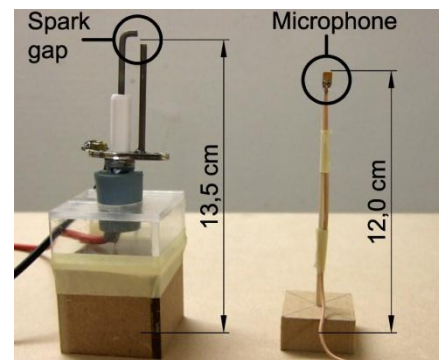


Figure 32: Spark gap and microphone

### Basic measurement setup

The scale model is located in Measurement room 3 of the Acoustic Laboratory at the TU/e. This room has a volume of 90 m<sup>3</sup>, or 90.000 m<sup>3</sup> scaled from 1:10 to 1:1. The volume of the auditorium hall at Het Muziektheater is however only 12.000 m<sup>3</sup>; more than 7 times smaller. Furthermore the ceiling height above the orchestra pit is ca. 15 m in the full scale situation, but over 20 m (2 m at 1:10) in the measurement room. In short, the measurement room is not very suitable to function as auditorium hall to the orchestra pit.

Nonetheless the first measurement series was performed in the scale model without any additional measures to influence the acoustics. As is shown in Figure 34 (chart on the left) this has resulted in extremely long reverberation times. A second measurement series was performed with slabs of convoluted foam (also known as 'egg crate foam') covering the open part of the pit (Figure 33), which has resulted in more realistic reverberation times between 0 and 2 s (chart on the right). All subsequent measurements have been performed with this foam covering.

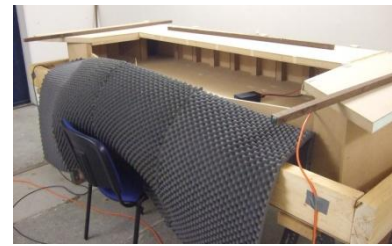
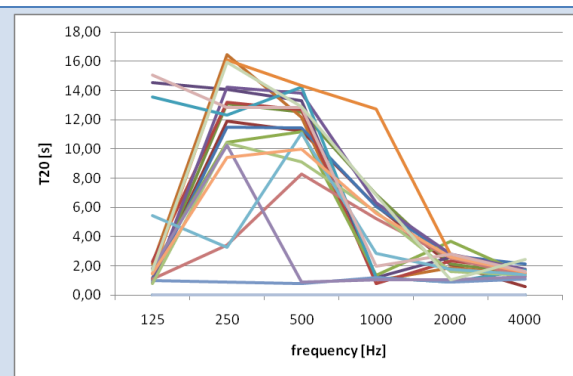


Figure 33: Basic measurement setup (top: opened, bottom: closed)

**T<sub>20</sub> [s] open scale model**



**T<sub>20</sub> [s] scale model covered by foam**

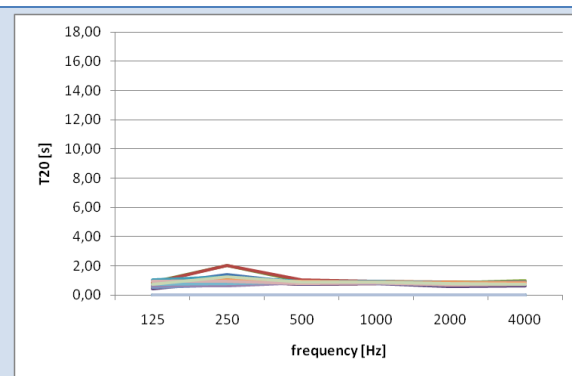


Figure 34: Reverberation time in scale model with and without foam, results are scaled 1:10 -> 1:1 and corrected for air absorption

Unfortunately the foam covering does not provide sufficient sound insulation for sound transmission at the open part of the orchestra pit. Mainly at transmission S2R6 a so-called 'double slope decay' curve was found for most pit configurations, with the first part relating to the scale model and the second to the reverberation room, see Figure 35.

Consequently the T<sub>20</sub> could not be calculated for those transmissions and it was decided to calculate the T<sub>10</sub> instead. This turned out to be necessary for the following transmissions:

Emp H	S1R6	S2R6			
Emp L	S2R6	S2Rc			
Dif L fr	S2R7				
Dif H	S1R6	S2R6			
Abs H	S2R6	S2Rc	S1R6	S3R6	S2R7
Abs H ce	S2R6				

**Decay curve Dif H S2R6 at 500 Hz**

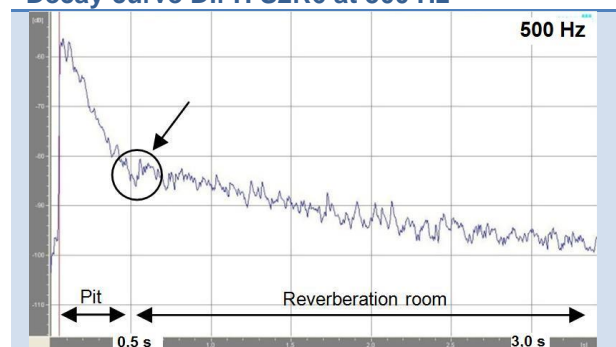


Figure 35: Double slope decay curve

The left chart in Figure 36 shows the differences between  $T_{20}$  and  $T_{10}$  for some of those transmissions. Furthermore it was assessed whether other parameters such as the  $LQ_{7-40}$  were still reliable. For this purpose the  $LQ_{7-40}$  was calculated twice: first based on an original file with a double slope decay curve, after which the file was cut off at the slope discontinuity (see circle in Figure 35) and a second calculation was performed. The results of that experiment are displayed in Figure 36 (chart on the right). The differences between the results are negligible, especially at octave bands 500 – 2000 Hz, which are important for the calculation of the single number averages of  $LQ_{7-40}$ .

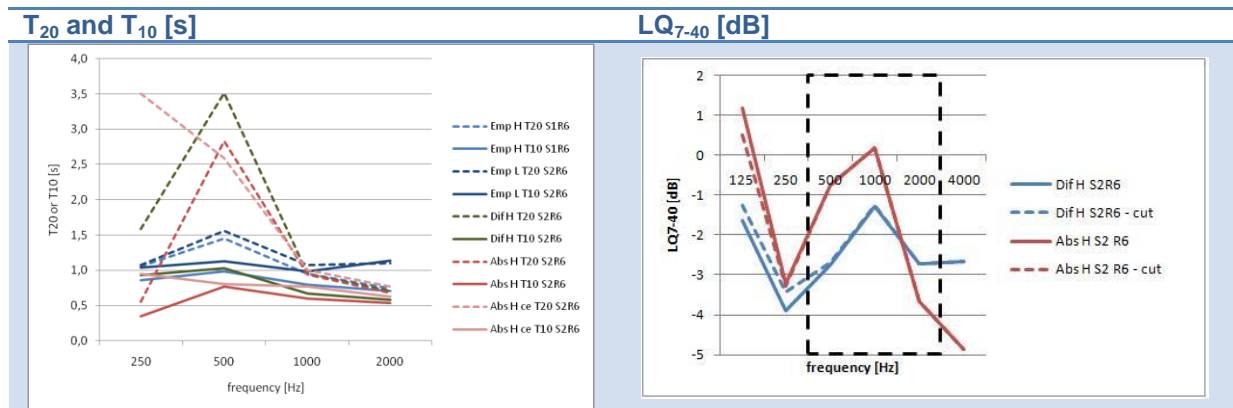


Figure 36: T<sub>20</sub> versus T<sub>10</sub> (left) and reliability of LQ<sub>7-40</sub> calculation (right)

To conclude, the reverberation time ( $T_{20}$ ) at the open part of the pit could not be accurately measured with the basic measurement setup due to reflections from the reverberation room, but calculation of other parameters seems to be sufficiently accurate. The reverberation time was therefore calculated with  $T_{10}$  instead of  $T_{20}$  in some cases.

### 3.1.3 VALIDATION OF THE SCALE MODEL

All measurement setups were named with abbreviations, which will be presented later. The situation used for the validation of the model was named 'Emp H', i.e. empy pit with a high floor position. To assess how well the acoustics in the scale model (Emp H) correlate to those in the real orchestra pit (MZT), the results were compared for each parameter.

#### Reverberation time

The reverberation time in the scale model is on average 0,3 s shorter than in the real pit, and the difference between open and covered is much smaller in the scale model, see Figure 37. The EDT is only 0,1 s shorter in the scale model than in MZT, but again the difference between open and covered found in the real pit is not found in the scale model. This is likely to be caused by the absence of late reflections from the hall; in the scale model all sound leaving the pit is absorbed by the foam covering. The fact that the average EDT relates so well to the real pit – even a slight peak was found at 500 Hz in both cases – is quite remarkable.

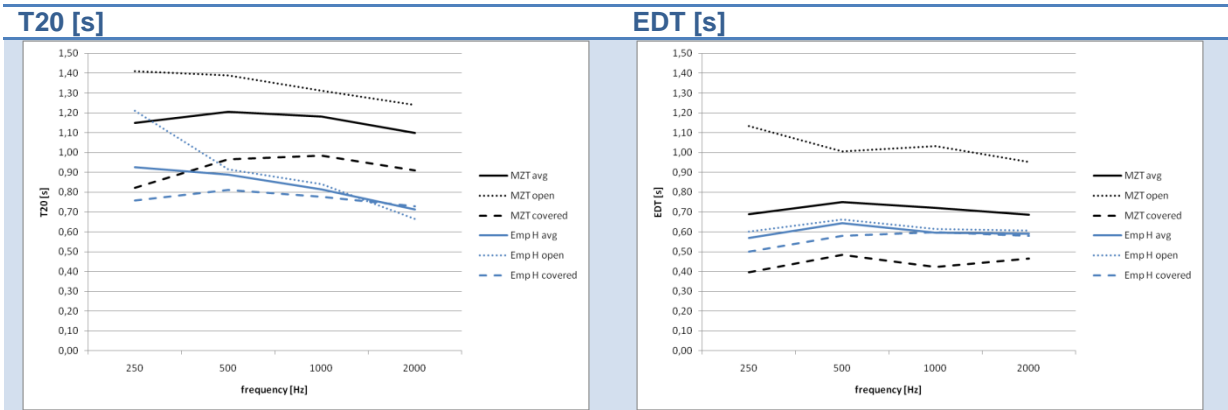


Figure 37: MZT vs. Emp H; Reverberation time and Early Decay time

### Sound strength

The sound strength 'G' is on average 1,1 dB higher in the scale model than in MZT and the early sound strength 'G<sub>5-80</sub>' 1,2 dB higher. In the open part of the pit the difference is the smallest, while largest differences are found for the across transmissions, mainly S2R5 and S2R7. In general the results of the scale model match remarkably well with the results obtained from the real pit, see Figure 38 and Figure 39. These figures also show clearly that the trends found with G<sub>5-80</sub> are very similar to those of G.

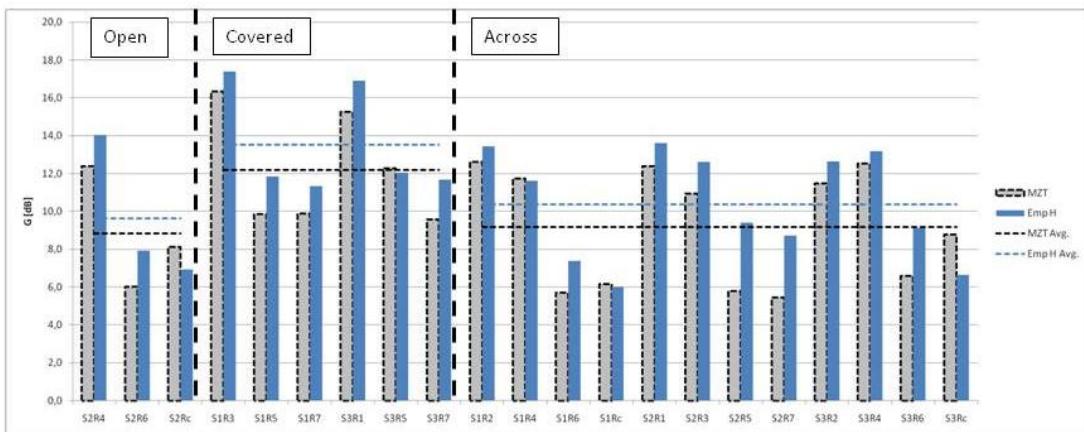


Figure 38: Comparison Emp H to MZT, sound strength G

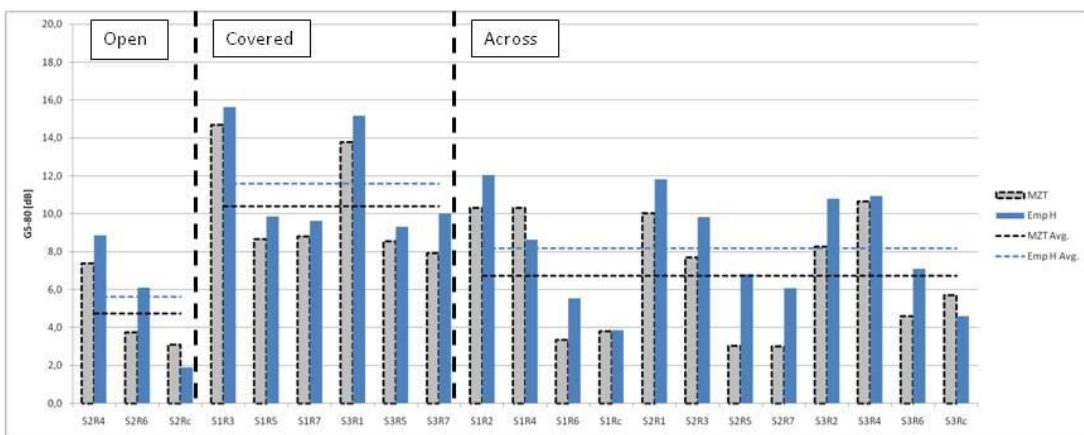


Figure 39: Comparison Emp H to MZT, early sound strength G<sub>5-80</sub>

### LQ<sub>7-40</sub>

The LQ<sub>7-40</sub> is on average 1,5 dB lower in the scale model than in MZT, which is a rather good match. Looking at the results at different positions the correlation seems less good, see Figure 40. The average values and the course over different frequencies however correlate rather well, see Figure 40 and Figure 41.

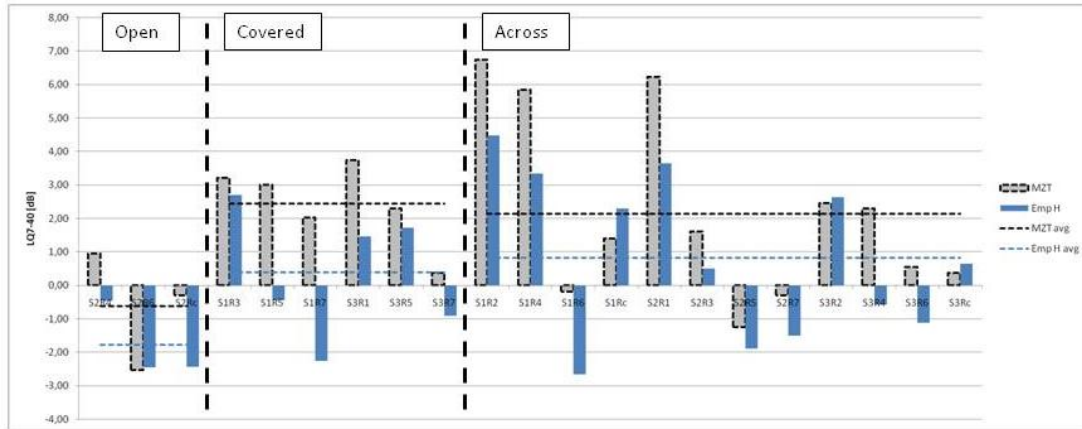


Figure 40: Comparison Emp H to MZT, LQ7-40 (avg. 500-2000 Hz)

### LQ<sub>7-40</sub> [dB] – by octave band

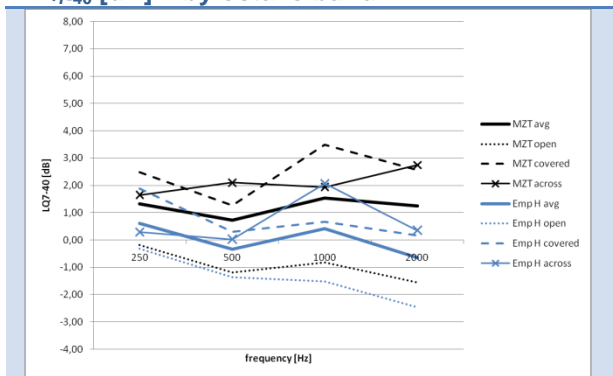


Figure 41: Comparison Emp H to MZT, LQ7-40, by frequency

### Early and late support; ED80 and LD80

Figure 43 displays the support and ED80 and LD80 of both Het Muziektheater and the scale model. The results for early support and ED80 are roughly 1,5 dB higher in the scale model than in MZT, while late support and LD80 are on average ca. 3 dB higher. The difference is especially large at positions underneath the stage (S1 and S3), see Figure 42. Due to these differences the results have shifted relative to each other, resulting in a larger spread for ST<sub>late</sub> and LD80 in the scale model than in MZT. The smallest deviation, i.e. the best match, was found for ED80.

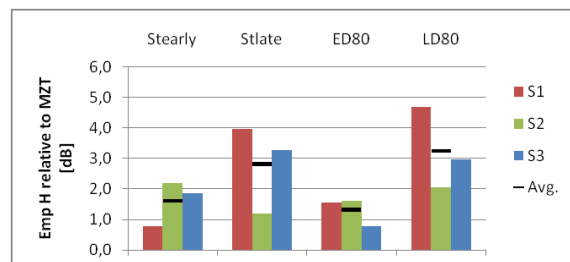


Figure 42: Difference between Emp H and MZT

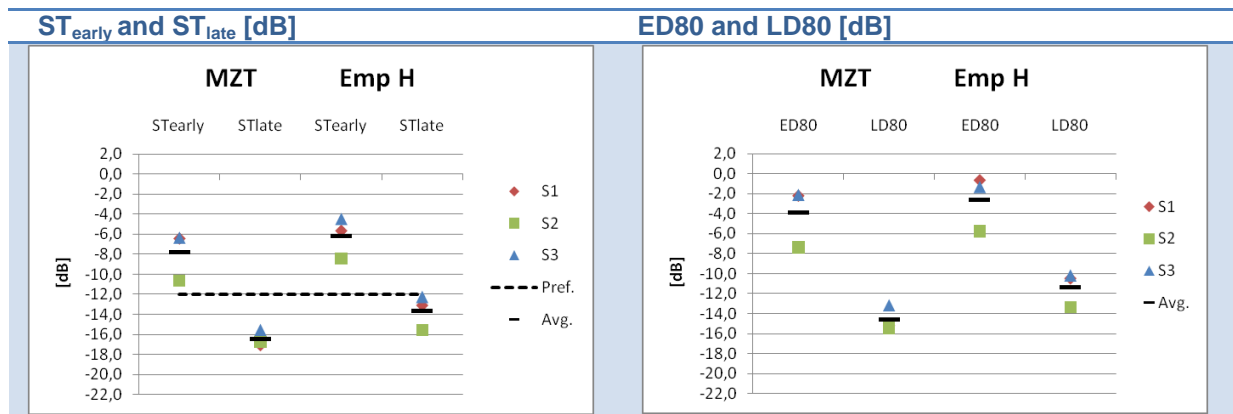


Figure 43: MZT vs. Emp H; Support and ED/LD80

## Conclusion

The acoustic conditions in the scale model match the acoustic properties of the orchestra pit of Het Muziektheater remarkably well. A big difference between the scale model and the real situation is found at the open part of the pit. In Het Muziektheater that part of the pit is connected to the auditorium hall, which sends late sound reflections back to the orchestra pit and influences for example the reverberation time in the pit. In the scale model however nearly all sound energy leaving the orchestra pit is absorbed by the foam covering and does not return as late reflections. Therefore parameters which incorporate late sound energy are less reliable when measured in the scale model.

A short overview of the findings:

- The reverberation time ( $T_{20}$ ) is much shorter in the scale model than in MZT and should only be assessed in the covered part of the scaled pit due to lacking reflections from the auditorium hall.
- The early decay time (EDT) in the model relates rather well to MZT, but again this parameter should only be assessed in the covered part of the pit.
- The sound strength (both  $G$  and  $G_{5-80}$ ) correlates well at nearly all positions.
- The  $LQ_{7-40}$  deviates quite strongly from the real pit (MZT) when comparing results for each transmission. The average values of the open, covered and across transmission are however proportionate to those of MZT and seem to be quite reliable.
- Early support and ED80 correlate well at all positions. The best match was found for ED80.
- Late support and LD80 seem to be less reliable for assessment in the scale model. Especially at S1 and S3 a big difference between the model and the real pit was found.

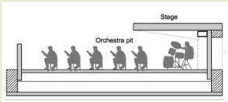
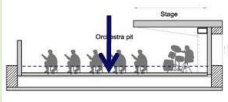
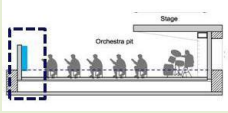
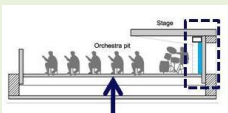
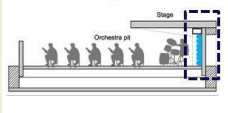
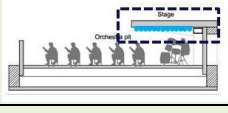


## 3.2 ASSESSMENT OF DIFFERENT PIT CONFIGURATIONS

### 3.2.1 MEASUREMENT SETUP

A total of 6 different pit configurations were assessed, see Table 9:

**Table 9: Overview of pit configurations**

	Code	Description	Section
Basic setup	<b>Emp H</b>	<u>Empty</u> pit, <u>high</u> floor position	
Variation 1	<b>Emp L</b>	<u>Empty</u> pit, <u>low</u> floor position	
Variation 2	<b>Dif L fr</b>	<u>Diffusers</u> at the <u>front</u> wall, <u>low</u> floor position	
Variation 3	<b>Dif H</b>	<u>Diffusers</u> at the <u>rear</u> wall, <u>high</u> floor position	
Variation 4	<b>Abs H</b>	<u>Absorbers</u> at the <u>rear</u> wall, <u>high</u> floor position	
Variation 5	<b>Abs H ce</b>	<u>Absorbers</u> at the <u>ceiling</u> (underneath the stage), <u>high</u> floor position	

The first variation to the basic setup is a lowered floor position, which would in reality imply removal of the elevated wooden floor and lowering of the pit lifts by 40 cm. For the second variation diffusers were located at the front wall of the pit. This variation was assessed with the floor in a lowered position, because of limited height of the front wall; with the floor in its normal (high) position the diffusers would be at the same height as the musicians. Results of measurements in the orchestra pit of the Stadsschouwburg (STS-D) have shown that diffusers need a certain distance to have full effect. It is therefore expected that diffusers at the front wall could positively affect the acoustics underneath the stage.



**Figure 44: Variation 2, Dif L fr, measurement setup**

The subsequent pit configurations were assessed with the floor in the high position. Convoluted foam or 'egg crate foam' was used for the tests with absorbers (Abs H and Abs H ce); the same foam that was used to cover the scale model with during the measurements. Figure 45 depicts the basic setup (Emp H) and variations 3 to 5.

### Basic setup: Emp H



### Variation 3: Dif H



### Variation 4: Abs H



### Variation 5: Abs H ce



Figure 45: Basic setup and variations at rear wall and ceiling

## 3.2.2 INFLUENCE OF PIT CONFIGURATIONS ON ACOUSTIC PROPERTIES

In this paragraph the main results of the assessment of different pit configurations are discussed. Table 10 displays the climatic conditions during the measurements.

Table 10: Climatic conditions during scale model measurements

Code	Date	Temperature	Relative humidity	Air pressure
Emp H	8 Feb 2011	21,5 °C	41,8 %	1025 hPa
Dif H	4 Feb 2011	20,9 °C	37,3 %	1020 hPa
Abs H	11 Feb 2011	21,5 °C	42,3 %	1014 hPa
Abs H ce	4 Mar 2011	21,3 °C	38,1 %	1035 hPa
Emp L	15 Feb 2011	21,3 °C	42,9 %	1002 hPa
Dif L fr	2 Mar 2011	21,0 °C	39,3 %	1035 hPa
Emp H or	4 Mar 2011	21,5 °C	36,7 %	1035 hPa

### Reverberation time: $T_{20}$ and EDT

Figure 46 shows the reverberation time and Early Decay Time of MZT, Emp H and all other pit configurations. For a clearer picture of the influence of each variation, the results were also plotted relative to Emp H, see Figure 47. The following was observed:

- Lowering the floor (Emp L) has the largest influence on both reverberation time and EDT with an increase of ca. 0,2 s. The reverberation time is most affected in the open part, while the EDT increases the most in the covered part of the pit.
- Addition of diffusers in the front causes the reverberation time to decrease slightly: ca. 0,1 s (Dif L fr relative to Emp L). The EDT is however hardly affected by the diffusers.
- Addition of absorption at the rear wall (Abs H) causes the reverberation time to decrease slightly throughout the pit, but does not affect the EDT underneath the stage.
- Addition of absorption at the ceiling (Abs H ce) does not significantly affect the reverberation time, but does cause the EDT to decrease uniformly throughout the pit by ca. 0,1 s. This time the EDT at the covered part is affected as well, which suggests that the EDT underneath the stage is mainly determined by floor and ceiling reflections, and less by reflections from the rear wall.

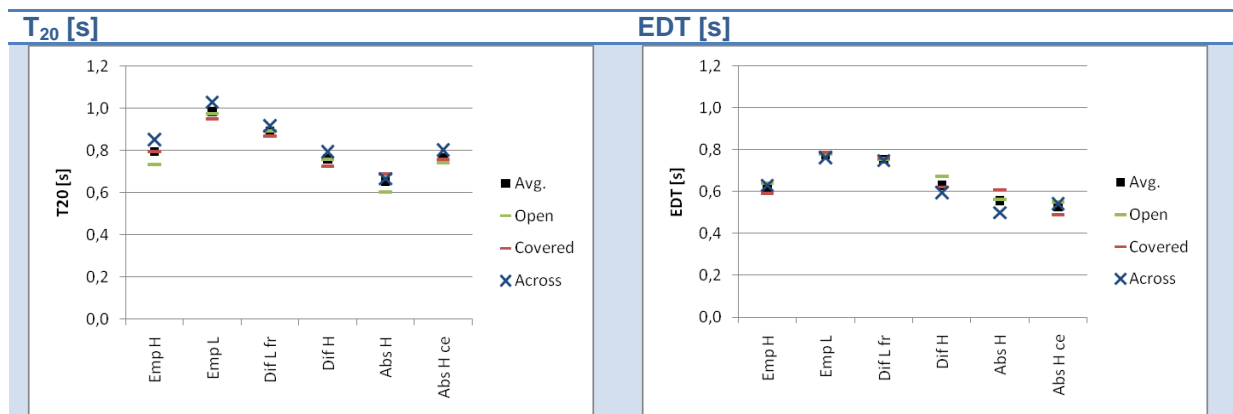


Figure 46: Single number averages,  $T_{20}$  and EDT of orchestra pit variations

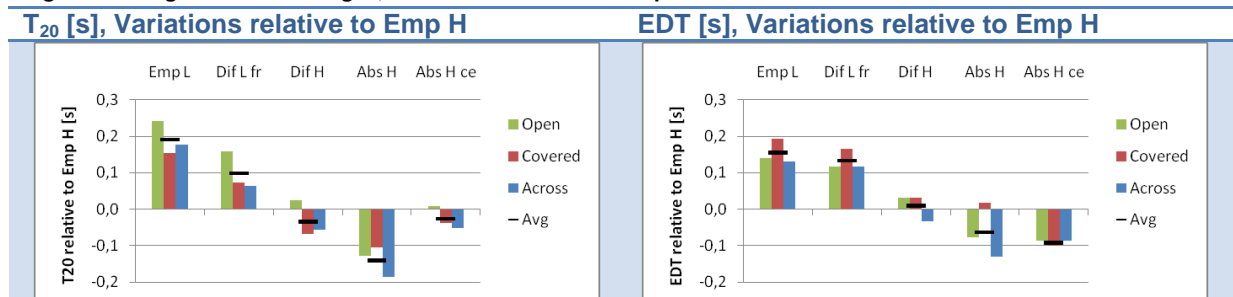


Figure 47: Influence of different pit configurations on  $T_{20}$  and EDT

An increase in both reverberation time and EDT is desirable in the orchestra pit of MZT, especially in the covered part of the pit. For this purpose lowering the floor with or without addition of diffusers seems to be a good option.

## Sound strength: G and G<sub>5-80</sub>

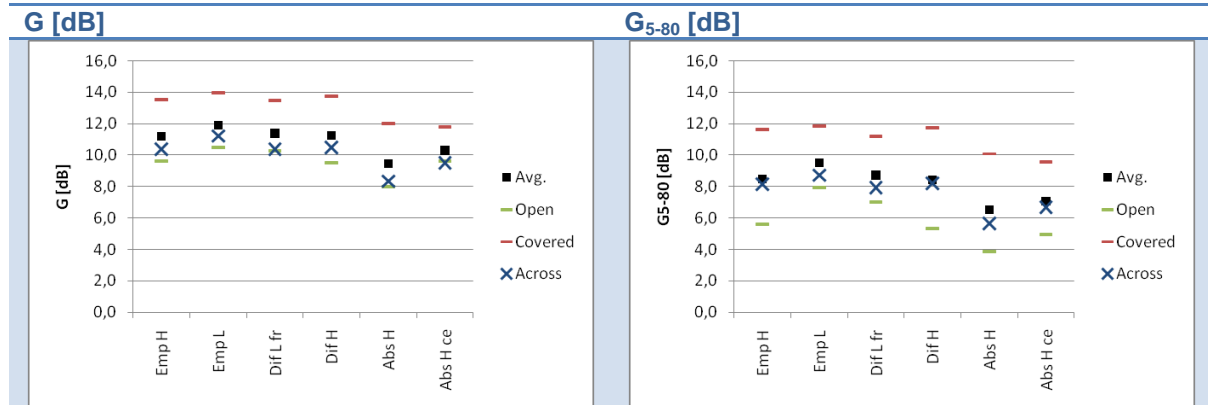


Figure 48: Single number averages, G (left) and G<sub>5-80</sub> (right) of different pit configurations

The single number averages of all variations in the scale model are displayed in Figure 48. Again the results of the variations are also presented relative to Emp H in Figure 49. The following was observed:

- Lowering the floor (Emp L) causes a slight, but not a significant increase in sound strength G. The early sound strength G<sub>5-80</sub> however does seem to be affected in the open part of the pit, with a 2 dB increase. This implies a higher density of early sound energy in the open part of the pit when the floor is lowered. The same effects are visible for Dif L fr.
- Due to the 2 dB increase of G<sub>5-80</sub> at the open part the difference between open and covered area is decreased by ca. 2 dB (both Emp L and Dif L fr) and consequently the uniformity throughout the pit is increased.
- The addition of diffusers at the rear wall (Dif H) does not affect the sound strength.
- Addition of absorbers causes the sound strength (both G and G<sub>5-80</sub>) to decrease. When the absorbers are located at the rear wall (Abs H), the decrease is quite uniform throughout the pit, while absorbers at the ceiling (Abs H ce) mainly affect the covered part of the pit.
- Furthermore absorbers at the ceiling cause a more uniform distribution of both G and G<sub>5-80</sub> by decreasing the difference between open and covered (-1,7 dB and -1,4 dB respectively).

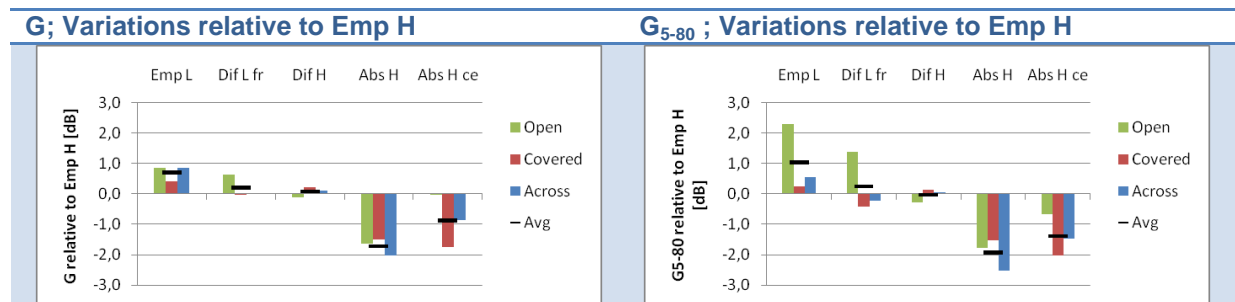


Figure 49: Influence of variations on strength G

## Level quotient: LQ<sub>7-40</sub>

Figure 50 shows the single number averages of all pit configurations and Figure 51 displays the results relative to Emp H. The following was observed:

- Lowering the floor causes a reduction of LQ<sub>7-40</sub> (-1 dB) throughout the pit.
- The addition of diffusers at the front wall (Dif L fr) causes a reduction mainly in the covered part of the pit (-1,8 dB), due to which the difference between open and covered area decreases by 1,2 dB. The across transmissions are however not affected by the diffusers.
- Addition of diffusers at the rear wall has no significant impact on the LQ<sub>7-40</sub>.

- The addition of absorption material seems to increase the  $LQ_{7-40}$  slightly. Absorbers at the ceiling mainly affect the covered part of the pit, while absorbers at the rear wall mainly affect the open part.
- Furthermore absorbers at the rear wall seem to cause a more uniform distribution of  $LQ_{7-40}$  throughout the pit by decreasing the difference between open and covered by 1,8 dB. The across transmissions however are less affected, resulting in a much higher  $LQ_{7-40}$  than transmissions in the open and covered area.

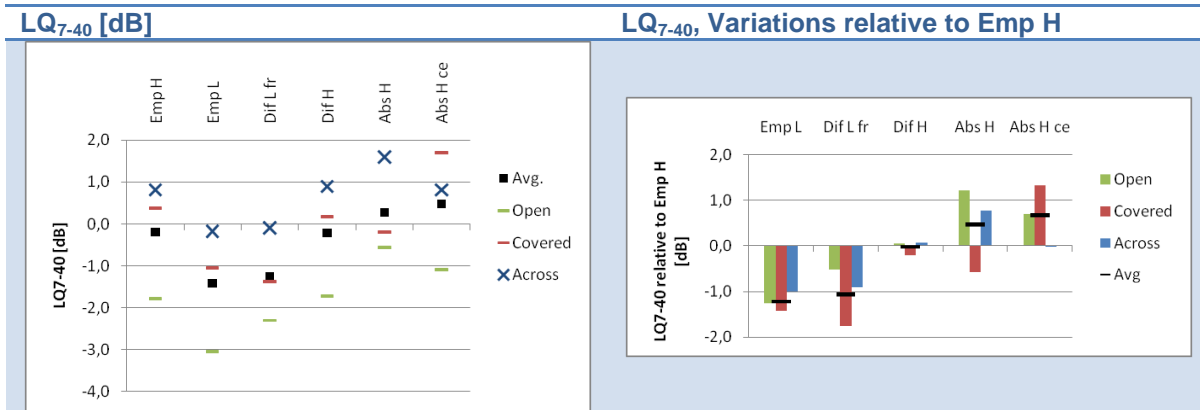


Figure 50: Single number averages,  $LQ_{7-40}$  of different pit configurations

Figure 51: Influence of variations on  $LQ_{7-40}$

### Early and late support; ED80 and LD80

The results of all variations are shown in Figure 53, while Figure 54 displays the results relative to Emp H.

The following was observed regarding early support and ED80:

- Lowering the floor causes a slight increase of nearly 2 dB at S1 and S2, but hardly affects S3. With diffusers at the front wall the effects are similar.
- Diffusers at the rear wall do not have a significant impact.
- Absorption at the rear wall (Abs H) causes a reduction of 2 to 3 dB at all three positions, while absorption at the ceiling (Abs H ce) mainly influences the  $ST_{early}$  and ED80 underneath the stage at positions S1 and S3.

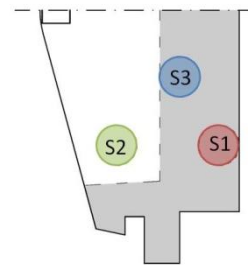


Figure 52: Location of S1, S2 and S3

These aspects were noticed when assessing late support and LD80:

- Lowering the floor (Emp L and Dif L fr) causes a rather uniform increase of ca. 2 dB.
- Diffusers at the rear wall do not influence the late support and LD80 significantly.
- The  $ST_{late}$  and LD80 decrease quite uniformly when absorption is added at the rear wall, but absorption at the ceiling mostly influences the covered area (S1 and S3).

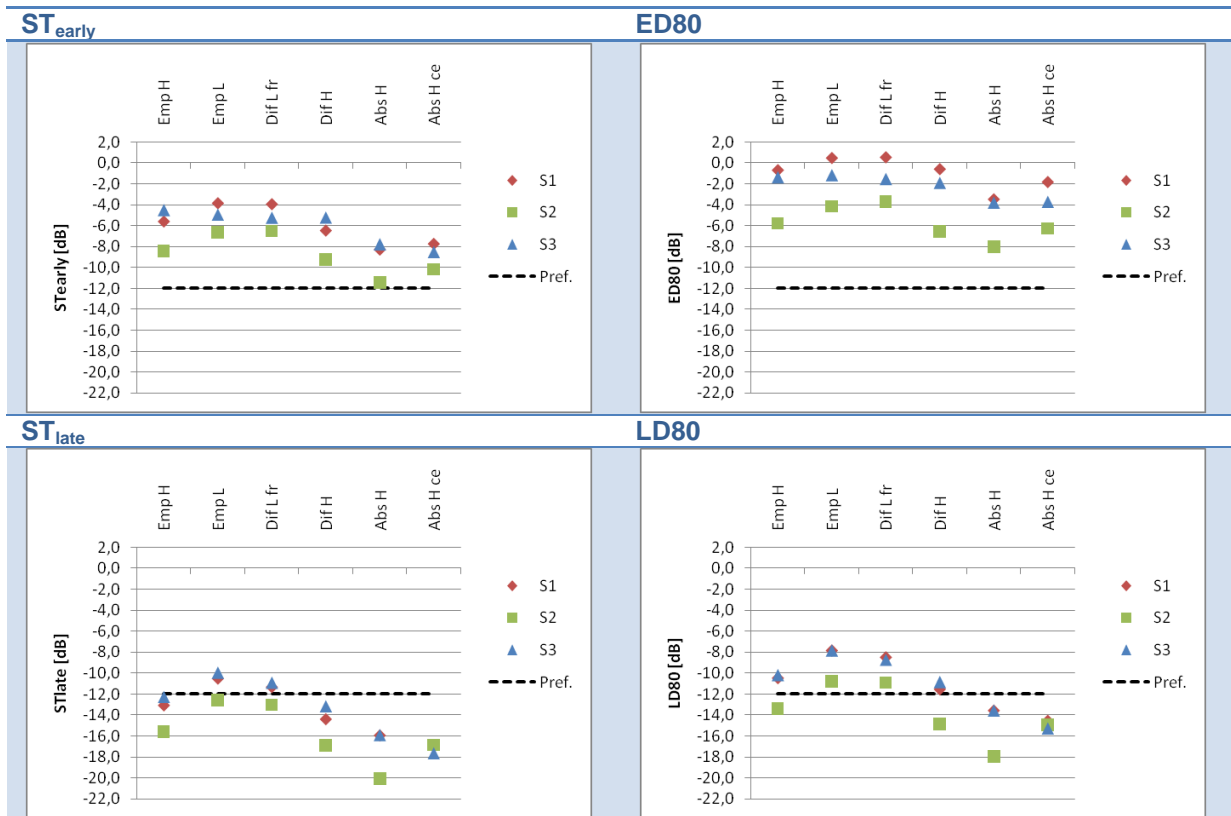


Figure 53: Influence of variations on Support and ED/LD80

During the validation procedure the correlation between late support in the orchestra pit (MZT) and the late support in the model was found to be small. Therefore one should be careful drawing conclusions from these results.

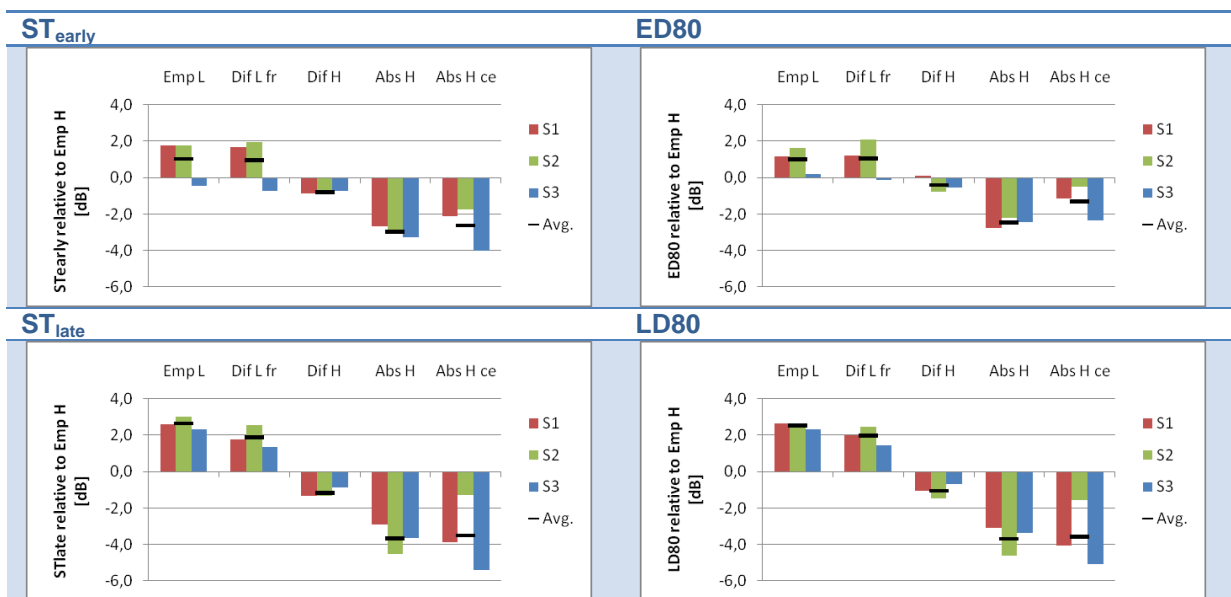


Figure 54: Support and ED/LD 80 of all variations in the scale model

### 3.3 EVALUATION OF THE RESULTS

#### Model validation

The measurements in the basic setup of the scale model have shown a good correlation to the measurements in the orchestra pit of Het Muziektheater (MZT). The sound strength 'G' and early sound strength  $G_{5-80}$  were found to be very similar even at individual positions in the pit. The early to late energy ratio  $LQ_{7-40}$  was found to be reliable when assessing pit averages of the open, covered and across transmissions. Furthermore the results of  $ST_{early}$  and ED80 show a rather good match with MTZ as well.

A disadvantage of the scale model is that reflections from the auditorium hall are absent, due to which parameters which include late reflections are less reliable. Both reverberation time ' $T_{20}$ ' and early decay time 'EDT' should not be assessed at the open part of the pit; measurements at the covered part are however quite reliable. The late support  $ST_{late}$  and LD80 were the least consistent with results of MZT. Therefore no conclusions were drawn based on these parameters.

#### Lowering the floor vs. adding absorption

Generally lowering the floor and addition of absorption seems to have an opposite effect on the acoustics of the orchestra pit. This is likely to be caused by a shift in the ratio between early and late reflections. When the floor is lowered this ratio shifts in the favor of late reflections, resulting in a lower  $LQ_{7-40}$ . When absorption is added – either at the rear wall or the ceiling – the ratio shifts in favor of early reflections due to a decreased amount of late reflections, resulting in a higher  $LQ_{7-40}$  (which was also found in STS-C). Furthermore lowering the floor causes a longer reverberation time and EDT, while addition of absorption decreases both, which is in line with the results found in STS-C.

Lowering the floor causes a more uniform distribution of G 5-80 throughout the pit. When diffusers are added the distribution of  $LQ_{7-40}$  becomes more uniform as well.

Addition of absorption causes the sound strength to decrease by 1-2 dB and both early and late support are lowered (-3 and -4 dB respectively). This implies that not only the ratio between early and late shifts, but the number of reflections decreases as well. Another important finding is that absorption at the ceiling mainly influences the covered part of the pit, causing a more uniform distribution of sound strength (both G and  $G_{5-80}$ ) throughout the pit. With absorption at the rear wall however, the distribution of the early to late energy ratio  $LQ_{7-40}$  is more uniform.

#### The influence of diffusers

Based on an assessment of the  $LQ_{7-40}$  diffusers at the rear wall seem to cause a more uniform distribution of sound at the open part of the Stadsschouwburg (STS-D). This same effect was not found when assessing results of the scale model. Diffusers at the front wall however do decrease the difference of  $LQ_{7-40}$  between open and covered area of the pit by ca. 1 dB. Diffusers at the rear wall however did not seem to influence the acoustics of the pit. Possibly the location and orientation of the diffusers was not chosen right. Furthermore there is no consensus which parameter best represents the influence of diffusers. The  $LQ_{7-40}$  seems to give an indication, but perhaps another calculation would derive more significant results.

## 4 CONCLUSIONS

Following the problems with loudness and ensemble playing in the orchestra pit of Het Muziektheater a research has been performed regarding the acoustics of orchestra pits. A study of previous research has shown that Het Muziektheater is not unique dealing with this problem; based on a survey among 46 theatres worldwide excessive sound levels are an issue in two third of the orchestra pits and in nearly half of the pits hearing other orchestra members was considered to be difficult.

Earlier investigations have mainly focused on sound transmission from pit to audience and not on the acoustics of the orchestra pit itself. To collect reference material measurements were performed in four Dutch orchestr pits: het Muziektheater (Amsterdam), Theater aan de Parade (Den Bosch), Theater De Vest (Alkmaar) and Stadsschouwburg (Eindhoven).

Thereafter the acoustics of the orchestra pit of Het Muziektheater were further studied using a 1:10 scale model. The influence of a lower floor position, addition of diffusers and addition of absorbers on the acoustics within the pit was assessed. Prior to this study 1:10 absorption properties of several materials for the scale model were assessed in a 1:10 scale model of a reverberation room and the scale model measurements method and system calibration methods were investigated. The measurements in the basic setup of the scale model have shown a good correlation to the measurements in the orchestra pit of Het Muziektheater (MZT).

### 4.1 THE ACOUSTICS IN ORCHESTRA PITS

#### **Conclusions based on measurements in four orchestra pits**

An important characteristic of acoustics in orchestra pits was found to be a high amount of early sound energy relative to late sound energy. As a consequence the sense of reverberance is generally low in orchestra pits. Actually all parameters that indicate the amount of early reflections were found to be much higher in the pits than on concert hall stages (bases on  $G_{5-80}$ ,  $ST_{early}$  and  $LQ_{7-40}$ ). Although a large amount of early reflections is generally considered to be favorable for ensemble conditions, it can also be too much. Ueno (2004) concluded that a higher level of early support (-10 to -7 dB) is disliked by musicians, because reverberant sound is masked and the room feels small. Furthermore there is a clear difference between the open and the covered part of the pit, with at the covered part an even stronger influence of early reflections.

Based on an analysis of the orchestra pit in De Vest versus the other pits, a uniform distribution of the early-to-late energy ratio ( $LQ_{7-40}$ ) throughout the pit was suggested to be a favorable condition.

In the orchestra pit of Het Muziektheater the sound strength was found to be relatively low and the early decay time at the open part to be relatively long. As both these parameters are partly dependant on the distance to the sound source, these results can be explained by the large size of the pit in Het Muziektheater. A long early decay time at longer distances at the open part indicates that perceived sound from a musician sitting further away is more reverberant that perceived sound from a musician nearby. A low sound strength does not necessarily mean that sound levels during rehearsals / performances will be low as well; sound levels are also dependant on the number of musicians and the type of instruments present.

#### **Conclusions based on assessment of different pit configurations in the scale model**

Lowering the floor and adding absorption to the orchestra pit seems to have an opposite effect on its acoustics. Both cause a shift in the ratio between early and late sound energy: lowering the floor increases the amount of late reflections, and adding absorption the amount of early reflections. The total sound pressure is however lowered by addition of absorption. Furthermore absorption at the ceiling influences mainly the covered part of the pit, while absorption at the rear wall influences the whole pit. Addition of diffusers at the front wall seems to cause a more uniform distribution of the early-



to-late energy ratio ( $LQ_{7-40}$ ) throughout the pit. The influence of diffusers at the rear wall was however difficult to assess.

Based on these results it is not possible to state which solution is the best. All pit configurations have their pros and cons. Lowering the floor seems to be a sensible option as it increases the amount of late reflections and decreases the amount of early reflections. However only addition of absorption has been successful in decreasing the sound strength. This research has mainly been a study of trends and further research is necessary to find applications for the orchestra pit of Het Muziektheater.

## 4.2 USE OF NEW PARAMETERS AND SYSTEM CALIBRATION FOR SCALE MODEL MEASUREMENTS

### Relevance of new parameters

During this research several rather new parameters were used:

- ED80 and LD80 as a possible substitute for early and late support in small spaces.
- $LQ_{7-40}$  to assess the influence of surrounding surfaces – such as walls and ceiling – on the ensemble conditions.
- $G_{5-80}$  as an alternative to  $LQ_{7-40}$

In line with the results of Chiang and Shu (2003) the ED80 and LD80 were highly correlated to the early and late support. ED80 was found to be higher and the LD80 to be lower than the early and late support respectively. This implies that indeed an amount of early reflections is concentrated in the interval 5-10 ms. That was to be expected based on the proximity of walls and ceiling to the measurement positions. For a study of trends both parameters seem to be suitable and it is unclear which is better. Possibly the ED80 and LD80 relate better to subjective experience; that would be a subject for further investigations.

The  $G_{5-80}$  was found to be highly correlated to the sound strength  $G$  in the orchestra pits. Recent research has shown that this is not the case on concert hall stages. (Wenmaekers et al., 2010). Although the trends found with  $G_{5-80}$  are similar to the trends found with  $G$ , it does indicate the amount of sound energy concentrated in the early energy.

The study of  $LQ_{7-40}$  has yielded some interesting results. It is the only parameter assessed during this research that seems to respond to the presence of diffusers. Furthermore it is the only parameter that indicated a big difference between the orchestra pit in De Vest and the other orchestra pits.

### System calibration for scale model measurements

Three different methods were assessed to determine reference sound pressure 'p10' for the calculation of the sound strength 'G':

- System calibration according to ISO 3741
- Measurements in an anechoic room
- Measurements at 1 m for the source

With all three methods reliable values of  $G$  were found. An important condition is however that both the calibration and the measurements to be calibrated are performed under the same climatic conditions.

## 5 RECOMMENDATIONS FOR FURTHER RESEARCH

### Recommendations for further research orchestra pits

- Assessment of other pit configurations
  - During this research rather extreme situations have been investigated. To find an optimum solution different combinations of lowering the floor, adding absorptions and adding diffusers are to be assessed.
  - Absorption material for example could be located near the percussion instruments. Furthermore the influence of different locations and orientating of diffusers will be an interesting subject of research.
- The influence of the orchestra on the acoustics of orchestra pits is an interesting and important topic. This could be assessed in the scale model as well with a 1:10 symphony orchestra.
- The directionality and sound power of different instruments also influences the musician's experience. This was not modeled with the current measurement method, but could be especially important for the acoustics at the covered part of the pit, where traditionally loud instruments are located.
- Finally the communication between the musicians in the orchestra pit, singers on stage and audience in the hall should not be forgotten. While optimizing the acoustic situation within the orchestra pit, the sound transmission to auditorium hall and to the stage should still be well balanced and sufficiently loud.

### Recommendations for further research scale model measurements

- During the measurements the scale model was covered with a blanket of convoluted foam to block reflections coming back from the reverberation room. Generally this was a satisfying solution, but when sound transmission at the open part of the pit was measured (directly underneath the foam covering) reflections from the reverberation room still influenced the impulse response. It would therefore be better to find a covering with a higher sound insulation.
- With the current measurement method frequencies ranging from 250 Hz to 2000 Hz (scaled 1:10 tot 1:1) could be assessed with sufficient reliability. With an improved method and/or improved equipment it might be possible to expand this frequency range. That way the tonal balance in the pit could be investigated as well. Furthermore research has shown that low frequencies are best transmitted through orchestras and are therefore an interesting indicator of acoustics when assessing an empty stage / orchestra pit.
- Further research is necessary to find a (better) way to assess the influence of diffusers on the sound field. With the current available parameters this has proved to be difficult.

## REFERENCES

- ❖ Barron, M., 1993. *Auditorium acoustics and architectural design*, 1st ed. London: E&FN Spon.
- ❖ Bijsterbosch, K.B.A., 2002. *Absorptie van publiekvlak in schaalmodel nagalmkamer - ontwikkelen van een meetmethode*, Technical University Eindhoven, Dep. of architecture, building and planning, Acoustic Laboratory, January 2002.
- ❖ Braak, E.W.M. van den, Hak, C.C.J.M., Luxemburg, L.C.J. van, 2009. New (stage) parameter for conductor's acoustics? - part 2: further investigation on LQ<sub>7-40</sub>, *Inter-noise 2009: innovations in practical noise control*, August 23-26 (2009), Ottawa, Canada.
- ❖ Braak, E.W.M. van den, Luxemburg, L.C.J. van, 2008. New (stage) parameter for conductor's acoustics?, *Acoustics '08 Paris*, June 29 - July 4 (2008).
- ❖ Bradley, J.S., 2010. Review of objective room acoustics measures and future needs. *Proceedings of the International Symposium on Room Acoustics, ISRA 2010*. Melbourne, Australia, 29-31 August 2010.
- ❖ Brebeck, D., 1967. *Die Schall - und Ultraschallabsorption von Materialien in Theorie und Praxis, insbesondere im Hinblick auf den Bau akustisch ähnlicher Modelle im Massstab 1:10*. Promotion thesis, technical academy of München, Germany.
- ❖ Chiang, W., Shu, Y., 2003. Acoustical design of stages with large plane surfaces in rectangular recital halls, *Applied Acoustics*, 64 (2003), pp. 863-884.
- ❖ Dammerud, J.J., 2009. Stage acoustics for symphony orchestras in concert halls, University of Bath, U.K., September 2009.
- ❖ Dammerud, J.J., Barron, M., Kahle, E., 2010. *Objective assessment of acoustic conditions on concert hall stages - limitations and new strategies*. Proceedings of the International Symposium on Room Acoustics, ISRA 2010. Melbourne, Australia, 29-31 August 2010.
- ❖ Drotleff, H., Leistner, M., 2007. *Room acoustic design of orchestra pits* [pdf], Fraunhofer Institut Bauphysik. Available at: <http://www.baua.de/cae/servlet/contentblob/676344/publicationFile/48415/Vortrag-Safe-Sound-2007-17.pdf>
- ❖ Feilding, C., 2010. College of Santa Fe auditory theory - *Lecture 021 Environment II [online]*, Santa Fe University of Arts and Design, New Mexico, U.S. Available at: [http://www.santafevisions.com/csf/html/lectures/021\\_environment\\_II.htm](http://www.santafevisions.com/csf/html/lectures/021_environment_II.htm) [accessed 25/01/2011]
- ❖ Gade, A.C., 1992. Practical aspects of room acoustic measurements on orchestra platforms, ICA14 Beijing 1992, F3-5.
- ❖ Gade, A.C., 2010. Acoustics for symphony orchestras; status after three decades of experimental research. *Proceedings of the International Symposium on Room Acoustics, ISRA 2010*. Melbourne, Australia, 29-31 August 2010.
- ❖ Gade, A.C., Kapenekas, J., Andersson, B.T., Gustafsson, J.I., 2001. *Acoustical problems in orchestra pits; Causes and possible solutions*, *Atti del Convegno Internazionale di Acustica ICA2001*, Roma, 2 -7 Settembre 2001.
- ❖ Gade, A.C., Mortensen, B., 1998. Compromises in orchestra pit design: A ten-year trench war in The Royal Theatre - Copenhagen, *J. Acoust. Soc. Am.*, 103(5), May 1998, pp. 2786-2786.
- ❖ Habel, H., 1985. *Festspielhaus und Wahnfried*, Prestel Verlag, München, Germany.
- ❖ Hak, C.C.J.M., Bijsterbosch, K.B.A., 2009. *Room acoustic scale model measurements using a "spark train"*, Proceedings of the NAG-DAGA 2009, Rotterdam.
- ❖ Hak, C.C.J.M., Hak, J., Wenmaekers, R.H.C., 2008. INR as an estimator for the decay range of room acoustic impulse responses. *Audio Engineering Society (AES) Convention Paper*, Amsterdam, The Netherlands, 124th convention 17-20 May 2008.
- ❖ Halmrast, T., Buen, A., Ihlen, G., 2002. *The influence of a large reflector over the orchestra pit in an opera house*, Oslo: Brekke and Strand Acoustics.
- ❖ Heide, A.H.M. van der, 2010. *The acoustics of orchestra pits - literature review and case study*, Master project 3, Physics of the Built Environment, Department of Architecture, Eindhoven, University of Technology.
- ❖ Heijnen, P., Kivits, M., 2009. *Akoestiek en comfort op podia*, Master project 3, Department of Building Physics and Systems, Faculty of Architecture, building and planning, Technical University Eindhoven, The Netherlands.
- ❖ Hidaka, T., Beranek, L.L., 2000. Objective and subjective evaluations of twenty-three opera houses in Europe, Japan, and the Americas, *Journal Acoustical Society of America*, 107(1), pp. 368-383.
- ❖ ISO 354:2003, *Acoustics - Measurement of sound absorption in a reverberation room*.
- ❖ ISO 3741:1999, *Acoustics - Determination of sound power levels of noise sources using sound pressure - Precision methods for reverberation rooms*.
- ❖ ISO/DIS 3382-1:2006 (E), *Acoustics - Measurement of room acoustic parameters - Part 1: Performance rooms*, International Organization for Standardization.
- ❖ Jin Yong Jeon, Jong Kwan Ryu, Yong Hee Kim, Shin-ichi Sato, 2009. Influence of absorption properties of materials on the accuracy of simulated acoustical measures in 1:10 scale model test, *Applied acoustics*, 70, pp. 615-625.
- ❖ Lange, P.A. de, Luxemburg, L.C.J. van, Muchall, R.C., 1996. The Acoustics of the Amsterdam Opera House "Het Muziektheater", Symposium Turin, Italy: The Cultural Heritage of Acoustics, October 14-16 (1996) pp. 1-7.

- ❖ Lautenbach, M.R., Vercammen, M.L.S., 2010. *Stage acoustics: Renovation of the concert hall de Doelen, Rotterdam and other stages*, Peutz bv Zoetermeer, Peutz bv Mook, Proceedings of the International Symposium on Room Acoustics, ISRA 2010, August 29-31 (2010), Melbourne, Australia.
- ❖ Lee, J., Behar, A., Kunov, H., Wong, W., 2005. Musicians' noise exposure in orchestra pit. *Applied Acoustics*, 66 (2005), pp. 919-931.
- ❖ Level Acoustics, 2008. *Rapport - Geluidmetingen orkestbak muziektheater Amsterdam*, report number LA.80607.R01, September 9th, 2008.
- ❖ Marshall, A.H., Gottlob, D., Alrutz, H., 1978. Acoustical conditions preferred for ensemble, *J. Acoust. Soc. Am.*, 64, pp. 1437-1442.
- ❖ NEN 3418:2003 (Du), *Ergonomie - het beoordelen van geluid op de arbeidsplaats*.
- ❖ Parati, L., Prodi, N., Pompoli, R., 2007. Computer model investigations on the balance between stage and pit sources in opera houses, *Applied acoustics*, 68(2007), pp. 1156-1176.
- ❖ Peutz Adviesbureau, 2003. *Onderzoek schadelijk geluid in orkesten*, Rapportnr. R816-3, June 24<sup>th</sup> 2003, Peutz & associates: Zoetermeer.
- ❖ The Amsterdam Music Theatre, 2010. *Geschiedenis* [online]. Available at: <http://www.het-muziektheater.nl/nl/over-ons/geschiedenis/> [Accessed 10/06/2010].
- ❖ Ueno, K., Tachibana, H., Kanamori, T., 2004. Experimental Study on Stage Acoustics for Ensemble Performance in Orchestra. *Proceedings of 18th ICA*, Kyoto, Japan.
- ❖ Vries, D. de, 2009. Report of meeting 'werkgroep orkestbak' on November 24, 2009. Persons present: Haan, H.W. de, Vermeulen, A., Stribos, S., Holtrop, M., and Vries, D. de, DDV Acoustics: Berkel en Rodenrijs.
- ❖ Zha, X., Fuchs, H.V., Drotleff, H., 2002. Improving the acoustic working conditions for musicians in small spaces, *Applied acoustics* 63 (2002), pp. 203-221.

## ACKNOWLEDGEMENTS

I would like to thank my supervisors Renz van Luxemburg, Constant Hak and Remy Wenmaekers for their guidance, for sharing their knowledge, for challenging me and for creating an informal and pleasant working environment. I also thank Nicole van Hout and Martijn Kivits for their assistance during the measurements and Marc Stotijn for sharing his experience from a musicians' point of view.

Furthermore this project would not have been possible without the aid of many employees of theatres investigated. First of all I would like to thank the people at Het Muziektheater: Frans Huneker for his quick responses and involvement, Hans-Willem de Haan for attending my final presentation, Fons Altena for his tour through the theatre, Caroline Peek for providing me with the floor plans and sections and Dirk Bakker Marcel van Houten and Antje Bartholly who I met during the tour. I also thank Stijn Stribos who introduced me to Het Muziektheater.

Not to forget Fred van der Kroon and Steven Giezen of Theater aan de Parade, Kees van Wijck of Stadsschouwburg Eindhoven and the people who welcomed me at Theater de Vest.

Finally I would like to express my gratitude to my family and friends, who supported me throughout the project.

Angela van der Heide

## APPENDIX I: SYSTEM CALIBRATION FOR MEASUREMENTS IN ORCHESTRA PITS

A system calibration of the measurement setup is necessary to be able to calculate the sound strength based on the measurements in orchestra pits. Strength (G) is defined as the ratio of the sound pressure at a measurement point and the sound pressure caused by the same source at 10 m distance in a free field. Strength is calculated using the following formula: [ISO/DIS 3382-1:2006]

$$G \text{ dB} = 10 * \log \frac{\int_0^{\infty} p^2 t dt}{\int_0^{\infty} p_{10}^2 t dt} = L_{pE} - L_{pE,10}$$

With:

$p(t)$  instantaneous sound pressure of the impulse response measured at the measurement point;

$p_{10}(t)$  instantaneous sound pressure of the impulse response measured at a distance of 10 m in a free field;

$L_{pE}$  and  $L_{pE,10}$  are the sound pressure exposure levels of  $p(t)$  and  $p_{10}(t)$  respectively.

According to this definition, the sound strength at 10 m from the source in a free field equals 0. At a distance of 1 m from the source in a free field, the sound pressure would be 10 times higher. This implies a theoretical sound strength of  $G = 10 * \log(10^2) - 10 * \log(1^2) = 20 \text{ dB}$  at 1 m from the source, assuming reflections are negligible at this distance.

Based on this knowledge the sound strength at several positions in a room can be calculated based on a measurement at 1 m from the source. For this research however it was decided to calibrate the system beforehand at the Acoustic Laboratory of the TU/e.

According to the following formula, it is possible to calculate the strength based on measurements in a diffuse sound field:

$$G \text{ [dB]} = L_{pE} - L_{pE,10} = (L_w + 10 * \log \frac{4}{A}) - ((L_w + 10 * \log(\frac{1}{4\pi r^2}))$$

As  $A = 0,16 * V/T$  (Sabin's formula) and  $r = 10 \text{ m}$ , the strength can be derived based on the volume (V) and reverberation time (T) of a reverberation room, independently of the source - receiver distance and the source power. An important condition is that microphones are placed outside the direct sound field of the sound source.

Measurements were performed according to ISO 3741 (1999) using two source and three receiver positions. All measurements in orchestra pits were later calibrated based on these measurements using software Dirac 4.1. To verify whether the calibration had been successful, the sound strength of the support measurements (at 1 m from the source) was checked to be around 20 dB.

## APPENDIX II: OVERVIEW OF MEASUREMENT RESULTS ORCHESTRA PITS

### Theatres:

<b>MZT</b>	Het Muziektheater, Amsterdam
<b>PAR</b>	Theater aan de Parade, Den Bosch
<b>VES</b>	Theater De Vest, Alkmaar
<b>STS-D</b>	Stadsschouwburg, Eindhoven – Diffusers at the rear wall
<b>STS-C</b>	Stadsschouwburg, Eindhoven – Curtain covering the diffusers

### Concert hall stages:

- Concertgebouw amsterdam
- Dr. Anton Philips Zaal
- De Doelen Rotterdam
- De Doelen Rotterdam, after renovation
- De Vereeniging Nijmegen
- Muziekcentrum Eindhoven
- Muziekcentrum Enschede
- Theater aan het Vrijthof Maastricht
- Casa da Musica with Canopy at 9 m height

Measurements were performed on these stages by Heijnen and Kivits, 2009. Measurements in Casa da Musica were performed by Level Acoustics in 2010. The results of those measurements have served as a reference for the acoustics in orchestra pits.

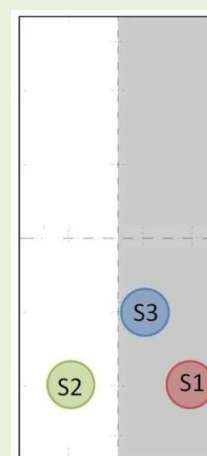
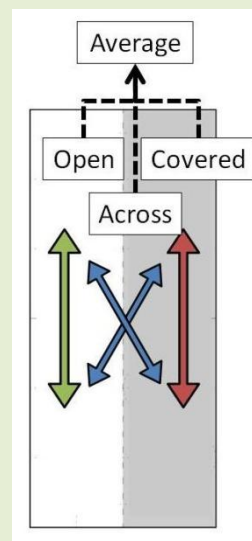
### Comparison orchestra pits to concert hall stages

The table below displays the average values of several parameters. 'Avg. stages' is the average of all concert hall stages; 'Avg. pits' is the average of all orchestra pits that were measured. The two columns on the right display the average values found in MZT and the difference of those to 'Avg. stages'.

Parameter	Freq. [Hz]	Avg. Stages	Avg. Pits	Difference (pits – stages)	Avg. MZT	Differences (MZT – stages)
<b>G [dB]</b>	500-1000	11	14	↑ 3	10	↓ -1
<b>G<sub>5-80</sub> [dB]</b>	500-1000	4	11	↑ 7	8	↑ 4
<b>LQ<sub>7-40</sub> [dB]</b>	500-2000	-4	2	↑ 6	1	↑ 5
<b>ST<sub>early</sub> [dB]</b>	250-2000	-14	-8	↑ 6	-8	↑ 6
<b>ST<sub>late</sub> [dB]</b>	250-2000	-14	-17	↓ -3	-16	↓ -2

## Overview of results orchestra pits

		MZT	PAR	VES	STS-D	STS-C
<b>T<sub>30</sub> [s]</b> (500 -1000 Hz)	<b>Avg</b>	<b>1,3</b>	<b>0,8</b>	<b>0,9</b>	<b>0,7</b>	<b>0,7</b>
	Open	1,4	0,9	1,0	0,8	0,8
	Covered	1,1	0,7	0,8	0,7	0,7
	Across	1,3	0,8	0,9	0,7	0,7
	Hall	1,4	1,0	1,3	0,9	-
<b>EDT [s]</b> (500 -1000 Hz)	<b>Avg</b>	<b>0,8</b>	<b>0,6</b>	<b>0,3</b>	<b>0,5</b>	<b>0,4</b>
	Open	1,0	0,7	0,3	0,5	0,5
	Covered	0,5	0,5	0,3	0,4	0,4
	Across	0,8	0,7	0,3	0,5	0,4
	Hall	1,7	1,0	1,1	1,0	-
<b>G [dB]</b> (500 -1000 Hz)	<b>Avg</b>	<b>10,1</b>	<b>15,8</b>	<b>15,1</b>	<b>14,4</b>	<b>13,3</b>
	Open	8,8	16,2	15,2	13,3	12,6
	Covered	12,2	17,3	15,2	15,9	14,4
	Across	9,3	14,1	14,8	14,0	12,8
	Hall	-0,3	1,8	-0,2	1,1	-
<b>G<sub>5-80</sub> [dB]</b> (500 -1000 Hz)	<b>Avg</b>	<b>7,5</b>	<b>13,6</b>	<b>12,3</b>	<b>12,1</b>	<b>10,0</b>
	Open	5,6	13,7	11,4	10,8	9,2
	Covered	10,8	15,7	13,5	14,1	11,2
	Across	6,3	11,6	12,0	11,2	9,6
<b>LQ<sub>7-40</sub> [dB]</b> (500 -2000 Hz)	<b>Avg</b>	<b>1,1</b>	<b>0,9</b>	<b>1,7</b>	<b>2,9</b>	<b>2,9</b>
	Open	-0,5	2,1	-3,5	2,8	2,1
	Covered	2,4	0,3	5,3	3,2	3,5
	Across	1,5	0,3	3,3	2,6	3,3
<b>ST<sub>early</sub> [dB]</b> (250 -2000 Hz)	<b>Avg</b>	<b>-7,8</b>	<b>-6,0</b>	<b>-7,7</b>	<b>-7,4</b>	<b>-9,3</b>
	S1	-6,4	-4,1	-7,7	-7,9	-8,9
	S2	-10,6	-9,9	-8,6	-9,1	-11,1
	S3	-6,4	-4,1	-6,8	-5,2	-8,0
<b>ST<sub>late</sub> [dB]</b> (250 -2000 Hz)	<b>Avg</b>	<b>-16,4</b>	<b>-12,6</b>	<b>-19,1</b>	<b>-17,5</b>	<b>-20,3</b>
	S1	-17,0	-12,4	-19,7	-18,0	-21,0
	S2	-16,8	-13,8	-19,7	-18,0	-19,2
	S3	-15,5	-11,8	-17,8	-16,4	-20,7
<b>ED80 [dB]</b> (250 -2000 Hz)	<b>Avg</b>	<b>-3,9</b>	<b>-2,4</b>	<b>-2,5</b>	<b>-2,7</b>	<b>-4,4</b>
	S1	-2,2	-0,9	-1,6	-2,1	-3,7
	S2	-7,4	-4,5	-4,2	-5,0	-5,5
	S3	-2,1	-1,9	-1,8	-1,1	-3,8
<b>LD80 [dB]</b> (250 -2000 Hz)	<b>Avg</b>	<b>-14,6</b>	<b>-10,0</b>	<b>-15,8</b>	<b>-14,6</b>	<b>-17,3</b>
	S1	-15,2	-9,5	-15,9	-14,5	-17,3
	S2	-15,4	-11,7	-17,2	-16,0	-16,9
	S3	-13,1	-9,0	-14,5	-13,3	-17,7





### INTRODUCTION

The scale model would ideally be built with materials with the same acoustic properties at scale 1:10 (so at 10x normal frequencies) as the materials in the full scale orchestra pit. However, to achieve such realistic scaling thorough research of possible materials is necessary. Therefore acoustic scale models are typically built with MDF, because this material is uniform, smooth and easy to process.

However, MDF is also quite heavy ( $750 \text{ kg/m}^3$ ), and the scale model of the orchestra pit of the MZT will be rather big with dimensions of approximately  $2,6 \times 1,2 \times 0,4 \text{ m}^3$ . To limit the weight of this model the absorption properties of XPS (Styrodur) and MDF were measured and compared. Dependent on the results parts of the model could consist of XPS, which is much lighter than MDF.

To assess the reliability of these measurements the influence of the sample volume on the outcome was evaluated. For this purpose the absorption coefficient of a Plexiglas block was determined, as well as that of several MDF samples with varying thickness. As the sound absorption of Plexiglas should theoretically be zero, the influence of merely the volume of a sample could be revealed. The MDF samples should all have the same absorption coefficient, but their different volumes might influence the outcome of the measurements.

Based on this material assessment it was decided to build the model entirely with MDF, and not with a combination of materials. In this Appendix the method to assess absorption properties of a material at scale 1:10 is described, followed by the results that have led to the conclusion to use MDF.

### METHOD

The acoustic absorption properties of a material are calculated based on the difference in reverberation time in a room with and without a test specimen. This reverberation room should be completely diffuse and have highly reflective surfaces. Guidelines to perform the necessary measurements are set in ISO 354 (2003). To perform absorption measurements at scale 1:10 all dimensions mentioned in ISO 354 (2003) were scaled accordingly.

#### Measurement setup

A Plexiglas reverberation room with a volume of  $0,357 \text{ m}^3$  and shaped like a truncated pyramid is available for measurements at scale 1:10 at the Acoustic Laboratory of the TU/e. Its dimensions are in line with ISO 354 (2003). [Bijsterbosch, 2002] Furthermore ISO 354 sets the following requirements for absorption measurements:

- At least three source and two receiver positions should be used to perform at least 12 measurements per test specimen.
- The receiver positions should be at least 15 cm apart, 20 cm from any sound source and 10 cm from any room surface and the test specimen.
- The sound source should be omnidirectional and source positions should be located at least 3 m apart.
- The specimen should be placed at least 7,5 cm from the room edges. Furthermore it should preferably not be parallel to the nearest edge of the room.
- During the measurements relative humidity should be between 30 % and 90 %, and the temperature should be at least  $15 \text{ }^\circ\text{C}$ . Ideally the climatic conditions should be uniform and constant throughout the duration of the measurements.

The integrated impulse response method was used for the measurements using a spark train. The spark discharger functions as an omnidirectional sound source and generates sound at frequencies up to 50 000 Hz. This means that the absorption coefficient can be calculated for frequencies up to 5 000 Hz when scaling back to 1:1. Computer software Dirac is used to record and evaluate the results. For more information about the spark train, see [Hak and Bijsterbosch, 2009].

Figure 55 shows the measurement setup with source positions located at three corners of the scale model, 11 cm from each wall and the spark at 10 cm height (S1 – S3). The receivers are suspended at 12 cm below the ceiling and 12 cm from wall at indicated positions (R1 – R4). Air pressure, temperature and relative humidity (P, T and RH) were registered during each measurement. The test specimen were placed in the middle of the model with the sides non-parallel to the walls, see Figure 55.

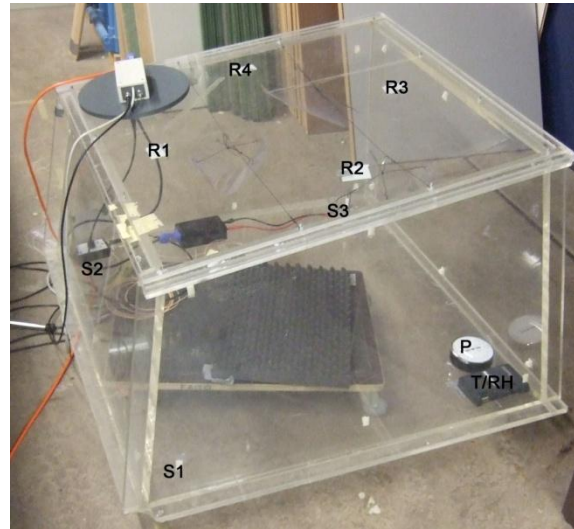


Figure 55: Measurement positions

### Calculation of the absorption coefficient

The reverberation time ( $T_{20}$ ) with and without test specimen is measured in the reverberation room. From these reverberation times the equivalent sound absorption area ( $A_T$ ) and sound absorption coefficient ( $\alpha_s$ ) of the test specimen can be calculated. For each specimen 12 measurements are performed using 3 source and 4 receiver positions. Subsequently the equivalent sound absorption area of the room with and without specimen ( $A_1$  and  $A_2$ ) is calculated using the following formula:

$$A_n = \frac{55,3 V}{c T_n} - 4V m_n$$

With:

V: volume of the reverberation room [ $m^3$ ]

c : speed of sound [m/s]

$T_n$ : reverberation time of the room without ( $T_1$ ) and with ( $T_2$ ) the test specimen, averaged over 12 measurement results for each terts band [s]

m: power attenuation coefficient [-]

The power attenuation coefficient 'm' incorporates the influence of humidity and temperature on the sound attenuation properties of air. This factor is highly important for scale model measurements, since the sound attenuation of air increases exponentially at higher frequencies. At very high frequencies (20 000 Hz and up) it becomes difficult to even correct for this in a reliable way. Therefore results will be presented for terts bands 250 – 2000 Hz (scaled 1:10 to 1:1).

When the air temperature (t) is between 15 °C and 30 °C, the speed of sound 'c' can be calculated with the following formula:

$$c = 331 + 0,6 * t$$

With:

c: speed of sound [m/s]

t: temperature [ $^{\circ}C$ ]

Finally the equivalent sound absorption area of the test specimen ( $A_T$ ) is calculated by subtracting  $A_1$  from  $A_2$ . The following formula is used to calculate the absorption coefficient of the test specimen:

$$\alpha_s = \frac{A_T}{S}$$

With:

$\alpha_s$ : sound absorption coefficient [-]

S: surface area of the test specimen [ $m^2$ ]

This calculation is carried out for each measured terts band.

### Validation of reverberation room

ISO 354 (2003) states that the reverberation room in which absorption measurements are performed should be completely sound diffuse. To achieve optimum diffuseness the absorption coefficient of a highly absorptive material was measured with an increasing amount of diffusers present. According to ISO 354 (2003) the reverberation room is sufficiently diffuse when the highest absorption coefficient is measured.

The diffusers were made of thin transparent sheets with an area of  $20 \times 20 \text{ cm}^2$  and suspended by thin metal wires, see Figure 56. To assess whether the addition of such diffusers would influence the results at all, it was decided not to add diffusers one by one, but in steps of 3. Convuluted foam was used as highly absorptive material, see Figure 57.



Figure 56: Diffuser made of thin transparent sheet.



Figure 57: Sample of convoluted foam

### Assessment of materials

After validation of the reverberation room, the following materials were assessed, see also Figure 58:

- MDF 16 mm
- MDF 16 mm, lacquered
- XPS foam 20 mm, smooth (top) side
- XPS foam 20 mm, sawn side
- XPS foam 20 mm, sawn side, lacquered
- Hardboard 4 mm

All test specimen have a surface area (S) of  $31 \times 44 \text{ cm}^2 = 0,136 \text{ m}^2$ , except for the hardboard specimen which is  $33,5 \times 33,5 \text{ cm}^2 = 0,113 \text{ m}^2$ . These dimensions were chosen based on the width and length of available foam ( $31 \times 60 \text{ cm}^2$ ) and the required ratio between width and length according to ISO 354 (2003) (between 0,7 and 1). Furthermore the sides of all test specimen (except the hardboard) were provided with a cardboard frame, to exclude sound absorption at the sides of the specimen.

### Assessment of sample volume

A second measurement series was performed to assess the reliability of the first. Sound absorption of the following materials was determined, see also Figure 58:

- Perspex, 16 mm
- MDF, 16 mm
- MDF, 9 mm
- MDF, 4 mm

The Perspex sample was constructed as a sandwich, with two outer layers of Perspex, a chipboard core and a sealant covering the sides. With the help of these specimen the influence of the sample's volume on the results is evaluated. The specimen are again  $31 \times 44 \text{ cm}^2$ , but are not provided with a cardboard framing.

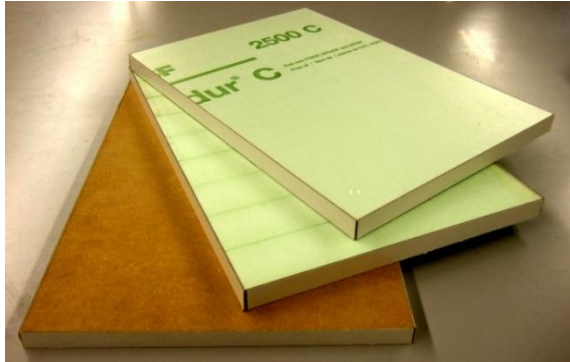


Figure 58: Test specimen, left: MDF 16 mm, XPS sawn side, XPS smooth side (bottom to top), right: Perspex, MDF 16, 9 and 4 mm

## RESULTS

All results presented here are corrected for air absorption of sound and scaled from 1:10 to 1:1.

### Validation of reverberation room

Measurements were performed with 0, 3 and 6 diffusers present respectively. **Error! Reference source not found.** shows the climatic conditions during these measurements.

Table 11: Climatic conditions during validation measurements

Measurement	Date	Empty			With specimen		
		$T_1$ [°C]	RH <sub>1</sub> [%]	$p_1$ [mbar]	$T_2$ [°C]	RH <sub>2</sub> [%]	$p_2$ [mbar]
0 diffusers	22/07/2010	24,9	53,4	1008	25,2	53,3	1008
3 diffusers	22/07/2010	25,3	54,1	1008	25,4	56,2	1008
6 diffusers	23/07/2010	22,8	55,5	1016	22,7	55,8	1016

The reverberation time ( $T_{20}$ ) of the empty room decreases significantly between 125 and 500Hz octave bands when the amount of diffusers is increased, see Figure 59. This effect is less obvious when the highly absorptive test specimen (convoluted foam) is introduced.

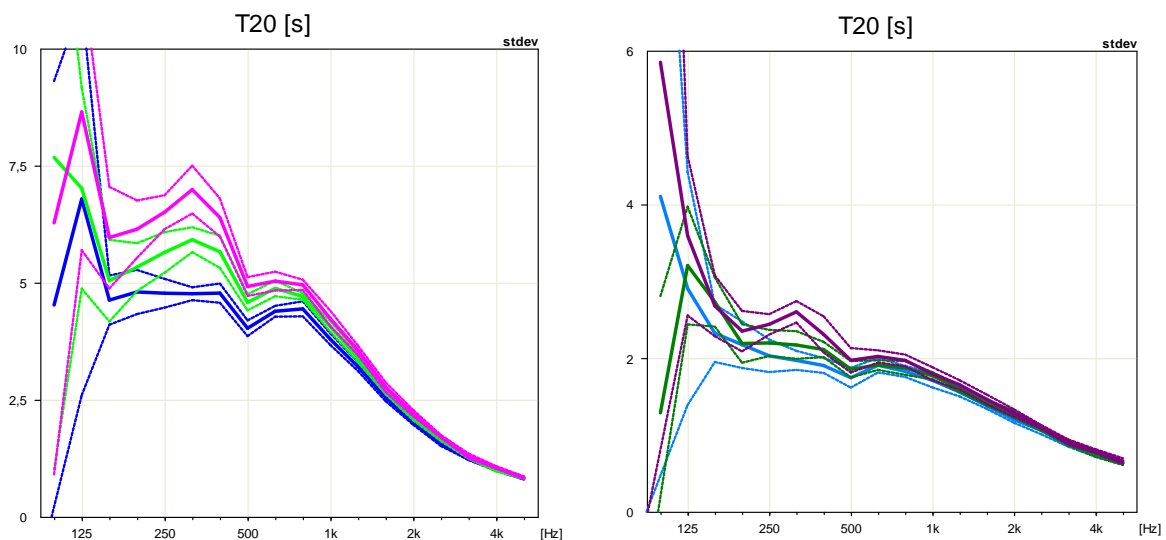


Figure 59: Reverberation time in empty room (left) and with specimen (right) with 0, 3 and 6 diffusers (purple, green and blue line respectively). Dotted lines indicate the standard deviation of the measurements.

Although the diffusers do seem to have an effect on the  $T_{20}$ , the calculated absorption coefficient does not change much, see Figure 60. Even still, at frequencies up to 1000 Hz the absorption coefficient is slightly higher with diffusers present. The difference between 3 and 6 diffusers is very small. The

absorption coefficient at frequencies below 250 Hz are not included in the graph, because the INR at low frequencies was not sufficiently high, which also shows in the graphs above.

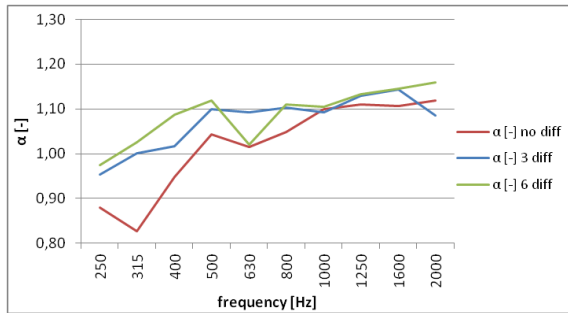


Figure 60: Absorption of foam with 0, 3 and 6 diffusers present

Table 12: Averaged absorption coefficients

n diffusers	$\alpha$ [-] 5-31,5kHz
0	1,09
3	1,11
6	1,11

### Conclusion:

Based on these results it was decided to use 3 diffusers for all subsequent measurements.

### Assessment of materials

Table 13 shows the climatic conditions during the measurements, **Error! Reference source not found.** contains the averaged sound absorption coefficients of each material and Figure 61 displays the sound absorption by tert's band.

Table 13: Climatic conditions during measurements of test specimen, assessment of materials

Measurement	Empty				With specimen		
	Date	$T_1$ [°C]	RH <sub>1</sub> [%]	$p_1$ [mbar]	$T_2$ [°C]	RH <sub>2</sub> [%]	$p_2$ [mbar]
MDF	29/07/2010	22,8	60,6	1013	22,7	60,4	1013
MDF-L	29/07/2010	22,8	60,6	1013	22,8	61,0	1013
Foam top	29/07/2010	22,8	60,6	1013	22,9	58,2	1013
Foam side	29/07/2010	22,8	60,6	1013	22,8	59,9	1013
Foam side-L	29/07/2010	22,8	60,6	1013	22,8	60,2	1013
Hardboard	02/08/2010	22,8	54,5	1016	22,9	55,4	1016

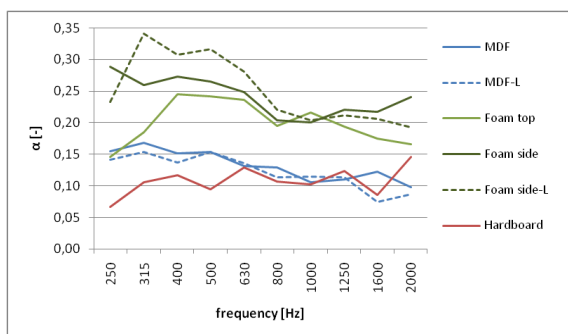


Figure 61: Absorption coefficient of MDF, foam and hardboard

Table 14: Average sound absorption coefficient of MDF, foam and hardboard

Material	$\alpha$ [-] 5-31,5kHz
MDF	0,13
MDF-L	0,11
Foam top	0,21
Foam side	0,23
Foam side-L	0,23
Hardboard	0,11

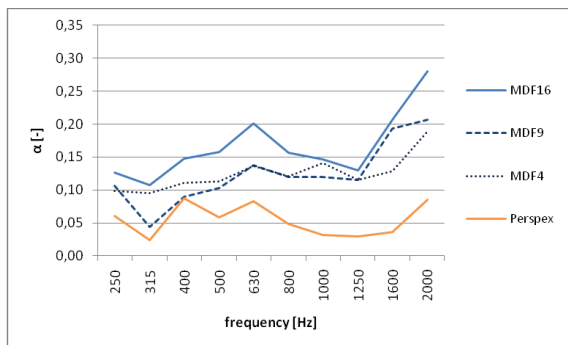
The sound absorption of XPS foam is clearly higher than that of MDF and hardboard. The lacquer does not seem to have much influence on the sound absorption properties. The foam side has a slightly higher absorption coefficient at most frequencies, but this difference could also be subscribed to measurement uncertainties. The difference between hardboard and MDF is very small, and consequently these materials are exchangeable when building the model.

### Assessment of sample volume

Table 15 shows the climatic conditions during the measurements table 16 contains the averaged sound absorption coefficients of each material and Figure 62 displays the sound absorption by tert's band.

**Table 15: Climatic conditions during measurements of test specimen, assessment of sample volume**

Measurement	Date	Empty			With specimen		
		T <sub>1</sub> [°C]	RH <sub>1</sub> [%]	p <sub>1</sub> [mbar]	T <sub>2</sub> [°C]	RH <sub>2</sub> [%]	p <sub>2</sub> [mbar]
Perspex	30/11/2010	21,1	37,2	1014	21,2	37,6	1014
MDF16	30/11/2010	21,1	37,2	1014	21,1	37,2	1014
MDF9	30/11/2010	21,1	37,2	1014	21,3	38,4	1014
MDF4	30/11/2010	21,1	37,2	1014	21,2	37,4	1014



**Figure 62: Sound absorption coefficient of MDF and Perspex**

**Table 16: Averaged sound absorption coefficients, MDF and Perspex**

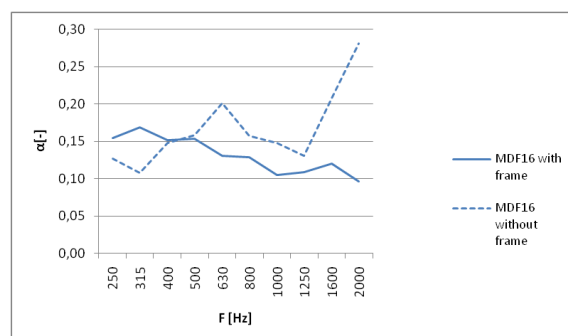
Material	$\alpha$ [-]
MDF16	0,17
MDF9	0,16
MDF4	0,16
Perspex	0,06

The sound absorption of 4 and 9 mm MDF seems to be slightly lower than that of the thickest sample (16 mm). The difference is however very small. The sound absorption of Perspex was found to be 0,06 on average, which is very low but not zero, as it theoretically should be. Whether this can be fully ascribed to the volume of the sample is however not clear, since the three MDF samples produced similar results.

### Comparison of results

The absorption coefficient of MDF calculated based on the latter measurements deviates slightly from the first measurements (assessment of materials), especially at high frequencies. Figure 63 depicts the results of both measurements in one chart. Various aspects could have caused this deviation:

- Different climatic conditions: The RH was approx. 60 % during the first and 37 % during the latter measurements. Perhaps the power attenuation coefficient 'm' did not sufficiently correct the results.
- The measurement uncertainty higher at high frequencies.
- The first sample was provided with a cardboard framing and the latter was not; this might have caused a different outcome.



**Figure 63: Absorption coefficient of 16 mm MDF, with and without cardboard frame, measured on 29/07/2010 and 30/11/2010 respectively.**

Finally the measurement results are compared to values in literature. The absorption properties of MDF were assessed and published by Jin Yong Jeon et al. (2009) see **Error! Reference source not found.** The absorption properties found based on the first measurements (MDF16 with frame) match best these literature values.

**Table 17: Absorption properties of MDF, measured values and values found in literature [Jin Yong Jeon et al., 2009]**

	<b>250</b>	<b>500</b>	<b>1000</b>	<b>2000</b>
<b>MDF16 with frame</b>	0,16	0,15	0,11	0,12
<b>MDF16 without frame</b>	0,11	0,17	0,15	0,24
<b>MDF literature</b>	0,07	0,12	0,13	0,14

---

## CONCLUSION

Based on the results presented in this Appendix it was decided to build the scale model entirely with MDF to create uniform and known acoustic conditions. The absorption coefficient of XPS foam is simply too high to function as a substitute. The results of the first measurements with 16 mm MDF ( $\alpha = 0,13$ ) are assumed to be the most realistic, because they match the results by Jin Yong Jeon et al. (2009) best and because the measurements were performed entirely according to ISO 354 (2003), i.e. with a frame around the specimen.

## APPENDIX IV: DEVELOPMENT OF THE MEASUREMENT METHOD FOR THE SCALE MODEL INVESTIGATIONS

### Consistency of the sound power produced by the spark gap

The sound power produced by the spark gap varies, see Figure 64. According to Hak and Bijsterbosch' (2009) research 40 sparks should be averaged to determine the strength with an uncertainty of 0,5 dB over a 95% confidence interval. Similar measurements were performed in a scaled anechoic room, based on which the standard deviation of the spark's relative strength ( $G_{rel}$ ) was found to be 1,5 dB, which is in line with the results found by Hak and Bijsterbosch (2009). Furthermore, three possible errors could occur during the measurements:

- Unexpected background noise;
- Bad timing: spark too quickly after another, resulting in two impulses in one file;
- Flashover of the spark at the wrong place.

Therefore measurements should always be monitored attentively to obtain reliable data.

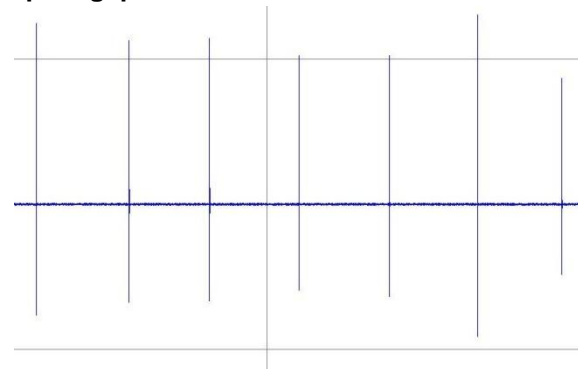


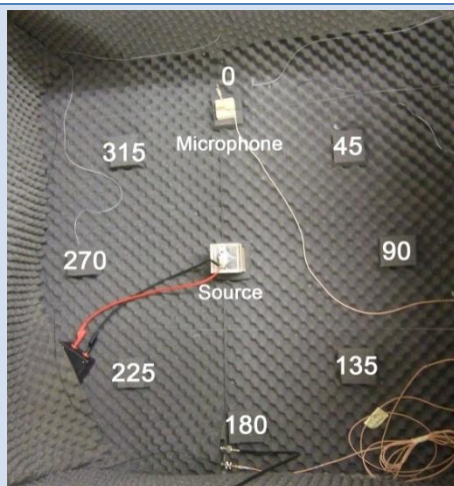
Figure 64: Sound pressure of 7 sparks over time interval.

### Directivity of the spark gap

The sound produced by the spark gap would ideally be equal in all directions, i.e. omnidirectional. To investigate the directivity of the spark gap measurements were performed in eight directions relative to the source in an anechoic room, see Figure 65.

All microphone positions were located at 30 cm from the source and for each direction 40 sparks were averaged. The first results obtained are represented by the blue line in Figure 65. Because of the peak at  $315^{\circ}$ , the measurement in this direction was repeated, resulting in the red line. Since all the results are within the range of  $\pm 0,5$  dB, differences can be ascribed to measurement uncertainty, and the source can be regarded as being fully omnidirectional in the horizontal plane.

### Measurement setup



### $G_{rel}$ [dB], avg. 500-1000 Hz

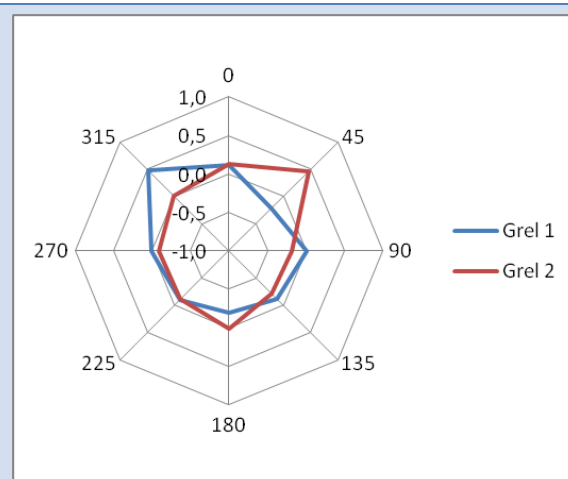


Figure 65: Measurement setup in anechoic room (left) and results (right). The displayed results are scaled 1:10  $\rightarrow$  1:1 and corrected for air absorption.



Figure 66 shows the measured relative strength ( $G_{rel}$ ) in eight directions relative to the frequency. Both at low and at high frequencies the results are rather unstable (top figure). When corrected for air absorption however, the results seem more stable at low frequencies (bottom figure). Based on these results it was decided to look only at results up to 2000 Hz (20 000 Hz during measurements).

#### Determination of required number of sparks

The number of sparks required to obtain reliable results are dependent on two things:

- the Impulse Response to Noise ratio (INR), and
- the consistency of the spark's sound power.

The INR is an important parameter to determine the reliability of measurement results. [Hak, Hak and Wenmaekers, 2008] According to ISO 3382-1 the INR should be at least 35 dB to determine the  $T_{20}$  and at least 45 dB to determine the  $T_{30}$ . Previous experience has shown that a 45 dB INR is difficult to achieve for scale model measurements. Therefore the goal was set to achieve an  $INR \geq 35$  dB at relevant frequencies (up to 2000 Hz). The number of measurements necessary to achieve this goal was determined based on measurements in an empty pit, with the longest source-receiver distance: S2R7. Due to the spectrum of the spark gap, see Figure 67, the INR was found to decrease with frequency. The 250 Hz octave band was chosen as the minimum frequency band to obtain reliable results from. The INR at this octave band was found to be 26 dB. In theory the INR should increase by 3 dB every time the number of measurements is doubled, see **Error! Reference source not found..** Based on this theory 8 measurements would be sufficient to reach the required INR.

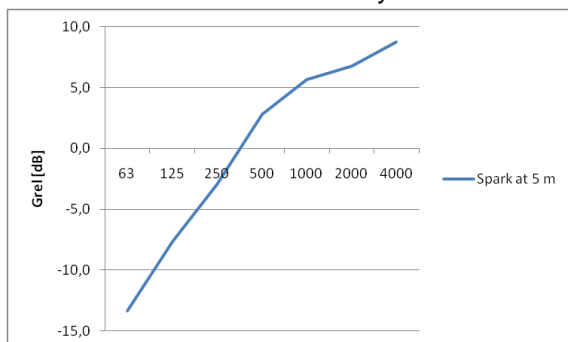


Figure 67: Spectrum of the spark gap,  $G_{rel}$  relative to frequency

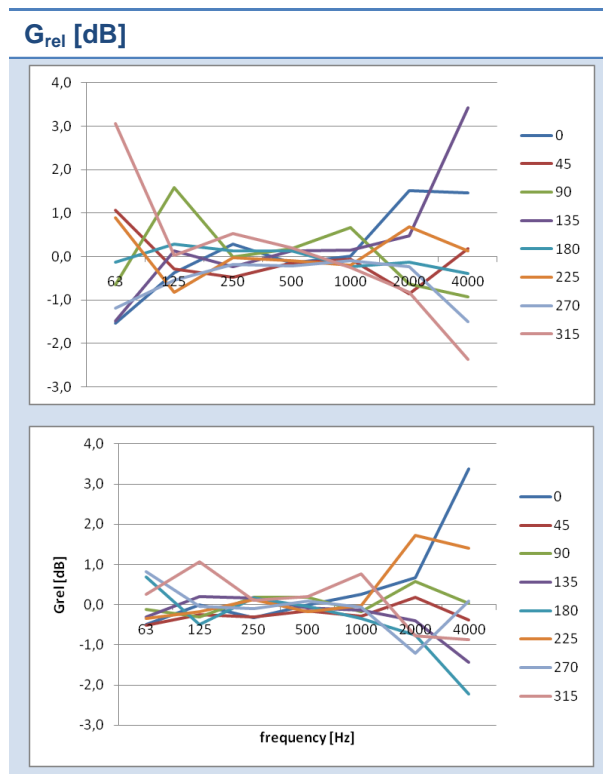


Figure 66: Relative strength of sparks, scaled 1:10 -> 1:1. Top: Not corrected for air absorption. Bottom: Corrected.

Table 18: Relation INR - number of measurements

INR S2R7 at 250 Hz	n measurements
26	1
29	2
32	4
35	8

Based on the standard deviation determined by previous measurements, the uncertainty level can be influenced by varying the number of measurements, see Table 19. In the scale model a total of 27 measurements are to be performed for each variation (i.e. variations at rear wall and varying floor height). Performing 40 measurements per measurement position would result in a massive amount of files - as each 'spark' is stored in one file - and consequently in a massive amount of time required to process these files. It was therefore decided to accept a slightly higher level of uncertainty.

Based on the INR it was decided to average at least 10 files for each measurement position. Because the measurements are not always stable, a total of 15 measurements is to be performed at each

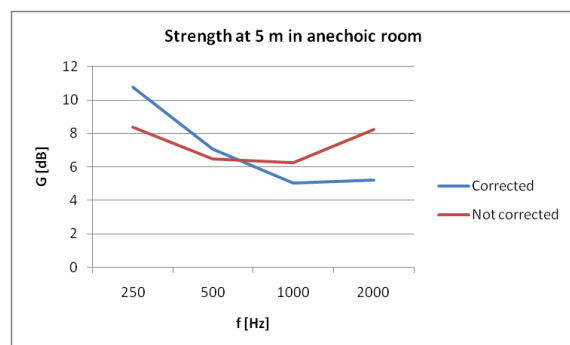
position, to allow a maximum of 5 files to be deleted afterwards. With 10 to 15 measurements the sound strength can be determined with an uncertainty in sound power of 0,6 – 0,7 dB and 95% confidence interval at the 500 and 1000 Hz octave bands, which is below the JND (1 dB) according to ISO 3382-1.

**Table 19: Standard deviation of sound strength based on 40 measurements, with correction for air absorption**

f [Hz]	s	$2*s/\sqrt{(40)}$	$2*s/\sqrt{(15)}$	$2*s/\sqrt{(10)}$
125	1,3	0,4	0,6	0,8
250	1,2	0,4	0,6	0,7
500	<b>1,1</b>	<b>0,4</b>	<b>0,6</b>	<b>0,7</b>
1000	<b>1,2</b>	<b>0,4</b>	<b>0,6</b>	<b>0,7</b>
2000	1,6	0,5	0,8	1,0
4000	1,8	0,6	0,9	1,1

### System calibration

An attempt was made to perform the system calibration according to ISO 3741 (1999) in a 1:10 reverberation room (also used for absorption measurements, see Appendix IV). To verify whether the calibration had been successful, measurements were performed in an anechoic room at 0,5 m distance to the source. When scaled to 1:1 the strength at this distance should be 6 dB. Ten sparks were measured, scaled and calibrated with and without a correction for air absorption, see Figure 68. The results at 500 and 1000 Hz are rather promising; both very close to 6 dB.

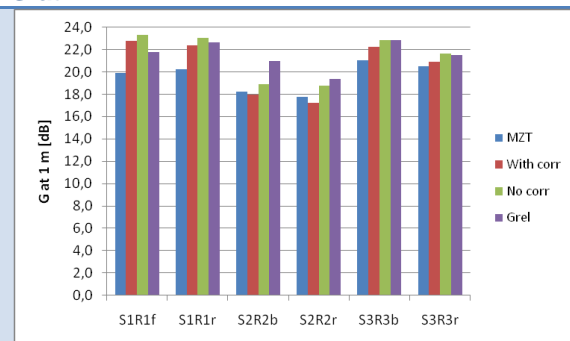


**Figure 68: Test of calibration method.**

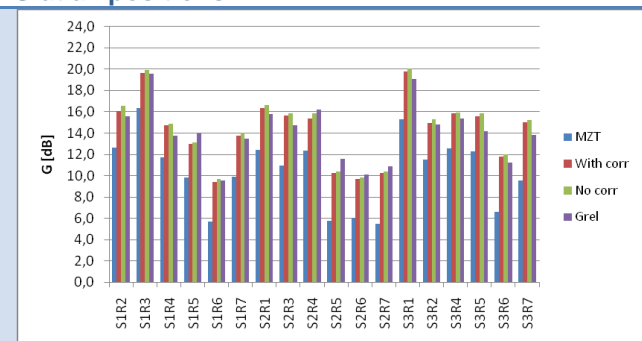
Finally a more elementary method to determine the strength was assessed as well. For that purpose the relative strength of 38 measurements at 0,5 m distance in the anechoic room was determined. After scaling the files to 1:1 and correcting for air absorption, 6 dB was subtracted from the results at each octave band. The obtained values now served as the reference value of the sound level at 10 m distance in a free field ( $L_{pE,10}$ ).

Figure 69 shows the strength measured in the scale model (Emp H) determined with the system calibration - with and without correction for air absorption - and with the relative strength at 10 m ( $G_{rel}$ ) as a reference. The blue columns represent the strength measured in the orchestra pit of Het Muziektheater (MZT). The different methods to determine G have resulted in rather similar results, and all correlate well with the results found in MZT.

### G at 1 m



### G at all positions

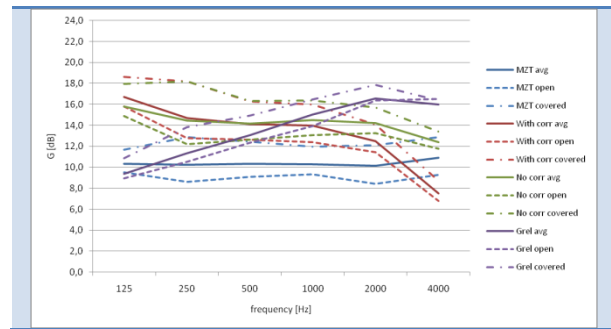


**Figure 69: Strength G in the scale model, determined with three different methods and compared to MZT**

### G relative to frequencies

**Figure 70: Strength G in the scale model relative to frequencies**

However, when plotting the strength over different octave bands significant differences are found between the different methods, see Figure 70. The G determined based on  $G_{rel}$  increases slightly as the frequency increases, while both other methods result in a decrease. When corrected for air absorption, G drops at higher frequencies (2000 – 4000 Hz).



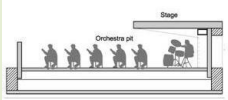
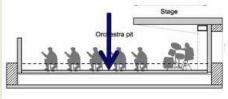
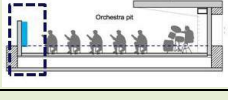
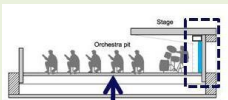
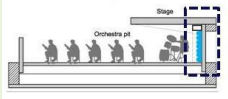
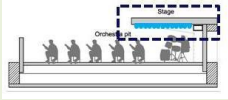
Based on these results it was decided to assess only the results at mid frequencies (500-1000 Hz), because they seem to be rather robust. All values of G presented later in this report were calculated based on  $G_{rel}$  at 10 m.

**Table 20: Climatic conditions during calibration measurements**

Code	Date	Temperature	Relative humidity	Air pressure
Kal Emp H	8 Feb 2011	21,3 °C	42,9 %	1025 hPa
Kal Dif H	4 Feb 2011	20,7 °C	38,0 %	1020 hPa
Kal Abs H	11 Feb 2011	21,5 °C	42,3 %	1014 hPa
$G_{rel}$ 0,5 m (1)	4 Mar 2011	22,6 °C	38,8 %	1020 hPa
$G_{rel}$ 0,5 m (2)	15 Feb 2011	21,0 °C	34,7 %	1027 hPa

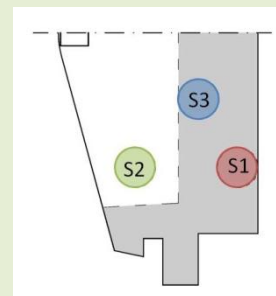
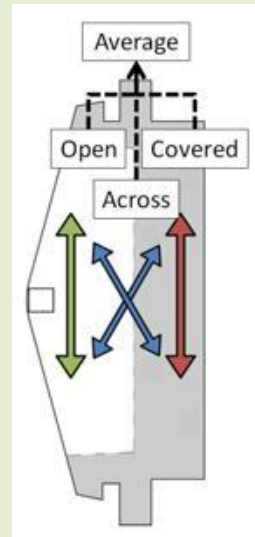
## APPENDIX V: OVERVIEW OF MEASUREMENT RESULTS SCALE MODEL

### Overview of pit configurations

	Code	Description	Section
<b>Basic setup</b>	<b>Emp H</b>	<u>E</u> mpy pit, <u>h</u> igh floor position	
<b>Variation 1</b>	<b>Emp L</b>	<u>E</u> mpy pit, <u>l</u> ow floor position	
<b>Variation 2</b>	<b>Dif L fr</b>	<u>D</u> iffusers at the <u>f</u> ront wall, <u>l</u> ow floor position	
<b>Variation 3</b>	<b>Dif H</b>	<u>D</u> iffusers at the rear wall, <u>h</u> igh floor position	
<b>Variation 4</b>	<b>Abs H</b>	<u>A</u> bsorbers at the rear wall, <u>h</u> igh floor position	
<b>Variation 5</b>	<b>Abs H ce</b>	<u>A</u> bsorbers at the <u>c</u> eiling (underneath the stage), <u>h</u> igh floor position	

### Validation of the scale model

		MZT	Emp H	Difference	
<b>T20 [s]</b> (500 -1000 Hz)	<b>Avg</b>	<b>1,2</b>	<b>0,8</b>	↓	<b>-0,4</b>
	Open	1,4	0,7	↓	-0,6
	Covered	1,0	0,8	↓	-0,2
	Across	1,3	0,9	↓	-0,4
<b>EDT [s]</b> (500 -1000 Hz)	<b>Avg</b>	<b>0,7</b>	<b>0,6</b>	↓	<b>-0,1</b>
	Open	1,0	0,6	↓	-0,4
	Covered	0,5	0,6	↑	0,1
	Across	0,7	0,6	↓	-0,1
<b>G [dB]</b> (500 -1000 Hz)	<b>Avg</b>	<b>10,1</b>	<b>11,2</b>	↑	<b>1,1</b>
	Open	8,8	9,6	→	0,8
	Covered	12,2	13,5	↑	1,3
	Across	9,2	10,4	↑	1,2
<b>G<sub>5-80</sub> [dB]</b> (500 -1000 Hz)	<b>Avg</b>	<b>7,3</b>	<b>8,5</b>	↑	<b>1,2</b>
	Open	4,7	5,6	→	<b>0,9</b>
	Covered	10,4	11,6	↑	<b>1,2</b>
	Across	6,7	8,2	↑	<b>1,4</b>
<b>LQ<sub>7-40</sub> [dB]</b> (500 -2000 Hz)	<b>Avg</b>	<b>1,3</b>	<b>-0,2</b>	↓	<b>-1,5</b>
	Open	-0,6	-1,8	↓	-1,2
	Covered	2,4	0,4	↓	-2,1
	Across	2,1	0,8	↓	-1,3
<b>ST<sub>early</sub> [dB]</b> (250 -2000 Hz)	<b>Avg</b>	<b>-7,8</b>	<b>-6,2</b>	↑	<b>1,6</b>
	S1	-6,4	-5,6	↑	0,8
	S3	-6,4	-4,5	↑	1,9
	S2	-10,6	-8,4	↑	2,2
<b>ST<sub>late</sub> [dB]</b> (250 -2000 Hz)	<b>Avg</b>	<b>-16,4</b>	<b>-13,6</b>	↑	<b>2,8</b>
	S1	-17,0	-13,1	↑	4,0
	S3	-15,5	-12,3	↑	3,3
	S2	-16,8	-15,6	↑	1,2
<b>ED80 [dB]</b> (250 -2000 Hz)	<b>Avg</b>	<b>-3,9</b>	<b>-2,6</b>	↑	<b>1,3</b>
	S1	-2,2	-0,7	↑	1,5
	S3	-2,1	-1,4	↑	0,8
	S2	-7,4	-5,8	↑	1,6
<b>LD80 [dB]</b> (250 -2000 Hz)	<b>Avg</b>	<b>-14,6</b>	<b>-11,3</b>	↑	<b>3,2</b>
	S1	-15,2	-10,5	↑	4,7
	S3	-13,1	-10,2	↑	3,0
	S2	-15,4	-13,4	↑	2,1
<b>Legend</b>				↑ ↓ Increase > 3 dB, or decrease > 3 dB ↑ Increase > 1 dB, or > 10 % (T <sub>20</sub> and EDT) → No significant difference ↓ Decrease > 1 dB, or > -10 % (T <sub>20</sub> and EDT)	



### Assessment of different pit configurations - results

		Emp H	Emp L	Dif L fr	Dif H	Abs H	Abs H ce
<b>T<sub>20</sub> [s]</b> (500 -1000 Hz)	<b>Avg</b>	<b>0,8</b>	<b>1,0</b>	<b>0,9</b>	<b>0,8</b>	<b>0,7</b>	<b>0,8</b>
	Open	0,7	1,0	0,9	0,8	0,6	0,7
	Covered	0,8	0,9	0,9	0,7	0,7	0,8
	Across	0,9	1,0	0,9	0,8	0,7	0,8
<b>EDT [s]</b> (500 -1000 Hz)	<b>Avg</b>	<b>0,6</b>	<b>0,8</b>	<b>0,8</b>	<b>0,6</b>	<b>0,6</b>	<b>0,5</b>
	Open	0,6	0,8	0,8	0,7	0,6	0,6
	Covered	0,6	0,8	0,8	0,6	0,6	0,5
	Across	0,6	0,8	0,7	0,6	0,5	0,5
<b>G [dB]</b> (500 -1000 Hz)	<b>Avg</b>	<b>11,2</b>	<b>11,9</b>	<b>11,4</b>	<b>11,2</b>	<b>9,4</b>	<b>10,3</b>
	Open	9,6	10,5	10,3	9,5	8,0	9,6
	Covered	13,5	13,9	13,5	13,8	12,0	11,8
	Across	10,4	11,2	10,4	10,5	8,3	9,5
<b>G<sub>5-80</sub> [dB]</b> (500 -1000 Hz)	<b>Avg</b>	<b>8,5</b>	<b>9,5</b>	<b>8,7</b>	<b>8,4</b>	<b>6,5</b>	<b>7,1</b>
	Open	5,6	7,9	7,0	5,3	3,8	5,0
	Covered	11,6	11,9	11,2	11,7	10,1	9,6
	Across	8,2	8,7	7,9	8,2	5,6	6,7
<b>LQ<sub>7-40</sub> [dB]</b> (500 -2000 Hz)	<b>Avg</b>	<b>-0,2</b>	<b>-1,4</b>	<b>-1,3</b>	<b>-0,2</b>	<b>0,3</b>	<b>0,5</b>
	Open	-1,8	-3,0	-2,3	-1,7	-0,6	-1,1
	Covered	0,4	-1,0	-1,4	0,2	-0,2	1,7
	Across	0,8	-0,2	-0,1	0,9	1,6	0,8
<b>ST<sub>early</sub> [dB]</b> (250 -2000 Hz)	<b>Avg</b>	<b>-6,2</b>	<b>-5,2</b>	<b>-5,2</b>	<b>-7,0</b>	<b>-9,2</b>	<b>-8,8</b>
	S1	-5,6	-3,9	-4,0	-6,5	-8,3	-7,8
	S2	-8,4	-6,7	-6,5	-9,2	-11,4	-10,2
	S3	-4,5	-4,9	-5,2	-5,2	-7,8	-8,5
<b>ST<sub>late</sub> [dB]</b> (250 -2000 Hz)	<b>Avg</b>	<b>-13,6</b>	<b>-11,0</b>	<b>-11,7</b>	<b>-14,8</b>	<b>-17,3</b>	<b>-17,2</b>
	S1	-13,1	-10,5	-11,3	-14,4	-16,0	-16,9
	S2	-15,6	-12,6	-13,0	-16,9	-20,1	-16,9
	S3	-12,3	-9,9	-10,9	-13,2	-15,9	-17,7
<b>ED80 [dB]</b> (250 -2000 Hz)	<b>Avg</b>	<b>-2,6</b>	<b>-1,6</b>	<b>-1,6</b>	<b>-3,0</b>	<b>-5,1</b>	<b>-3,9</b>
	S1	-0,7	0,5	0,5	-0,6	-3,5	-1,8
	S2	-5,8	-4,2	-3,7	-6,5	-8,0	-6,3
	S3	-1,4	-1,2	-1,5	-1,9	-3,8	-3,7
<b>LD80 [dB]</b> (250 -2000 Hz)	<b>Avg</b>	<b>-11,3</b>	<b>-8,8</b>	<b>-9,4</b>	<b>-12,4</b>	<b>-15,0</b>	<b>-14,9</b>
	S1	-10,5	-7,8	-8,5	-11,5	-13,5	-14,5
	S2	-13,4	-10,8	-10,9	-14,8	-18,0	-14,9
	S3	-10,2	-7,8	-8,7	-10,8	-13,5	-15,3

**Assessment of different pit configurations – comparison to basic setup (Emp H)**

		Difference with Emp H					
		Emp H	Emp L	Dif L fr	Dif H	Abs H	Abs H ce
<b>T<sub>20</sub> [s]</b> (500 -1000 Hz)	<b>Avg</b>	<b>0,8</b>	↑ 0,2	↑ 0,1	<b>0,0</b>	↓ -0,1	<b>0,0</b>
	Open	0,7	↑ 0,2	↑ 0,2	0,0	↓ -0,1	0,0
	Covered	0,8	↑ 0,2	0,1	-0,1	↓ -0,1	0,0
	Across	0,8	↑ 0,2	0,1	-0,1	↓ -0,2	-0,1
<b>EDT [s]</b> (500 -1000 Hz)	<b>Avg</b>	<b>0,6</b>	↑ 0,2	↑ 0,1	<b>0,0</b>	↓ -0,1	↓ -0,1
	Open	0,6	↑ 0,1	↑ 0,1	0,0	↓ -0,1	↓ -0,1
	Covered	0,6	↑ 0,2	↑ 0,2	0,0	0,0	↓ -0,1
	Across	0,6	↑ 0,1	↑ 0,1	0,0	↓ -0,1	↓ -0,1
<b>G [dB]</b> (500 -1000 Hz)	<b>Avg</b>	<b>11,2</b>	<b>0,7</b>	<b>0,2</b>	<b>0,1</b>	↓ -1,7	-0,9
	Open	9,6	0,9	0,6	-0,1	↓ -1,6	0,0
	Covered	13,5	0,4	0,0	0,2	↓ -1,5	↓ -1,7
	Across	10,4	0,9	0,0	0,1	↓ -2,0	-0,9
<b>G<sub>5-80</sub> [dB]</b> (500 -1000 Hz)	<b>Avg</b>	<b>8,5</b>	↑ 1,0	<b>0,2</b>	<b>0,0</b>	↓ -1,9	↓ -1,4
	Open	5,6	↑ 2,3	↑ 1,4	-0,3	↓ -1,8	-0,7
	Covered	11,6	0,3	-0,4	0,1	↓ -1,5	↓ -2,0
	Across	8,2	0,5	-0,2	0,0	↓ -2,5	↓ -1,5
<b>LQ<sub>7-40</sub> [dB]</b> (500 -2000 Hz)	<b>Avg</b>	<b>-0,2</b>	↓ -1,2	↓ -1,1	<b>0,0</b>	<b>0,5</b>	<b>0,7</b>
	Open	-1,8	↓ -1,3	-0,5	0,1	1,2	0,7
	Covered	0,4	↓ -1,4	↓ -1,8	-0,2	-0,6	↑ 1,3
	Across	0,8	-1,0	-0,9	0,1	0,8	0,0
<b>ST<sub>early</sub> [dB]</b> (250 -2000 Hz)	<b>Avg</b>	<b>-6,2</b>	↑ 1,0	<b>1,0</b>	<b>-0,8</b>	↓ -3,0	↓ -2,6
	S1	-5,6	↑ 1,7	↑ 1,7	-0,9	↓ -2,7	↓ -2,1
	S3	-4,5	-0,4	-0,7	-0,7	↓ -3,3	↓ -4,0
	S2	-8,4	1,8	↑ 1,9	-0,8	↓ -3,0	↓ -1,7
<b>ST<sub>late</sub> [dB]</b> (250 -2000 Hz)	<b>Avg</b>	<b>-13,6</b>	↑ 2,6	↑ 1,9	↓ -1,2	↓ -3,7	↓ -3,5
	S1	-13,1	↑ 2,6	↑ 1,8	↓ -1,3	↓ -2,9	↓ -3,9
	S3	-12,3	↑ 2,3	↑ 1,4	-0,9	↓ -3,7	↓ -5,4
	S2	-15,6	↑ 3,0	↑ 2,5	↓ -1,3	↓ -4,5	↓ -1,3
<b>ED80 [dB]</b> (250 -2000 Hz)	<b>Avg</b>	<b>-2,6</b>	<b>1,0</b>	↑ 1,0	<b>-0,4</b>	↓ -2,5	↓ -1,3
	S1	-0,7	↑ 1,2	↑ 1,2	0,1	↓ -2,8	↓ -1,1
	S3	-1,4	0,2	-0,2	-0,5	↓ -2,4	↓ -2,3
	S2	-5,8	↑ 1,6	↑ 2,1	-0,8	↓ -2,2	-0,5
<b>LD80 [dB]</b> (250 -2000 Hz)	<b>Avg</b>	<b>-11,3</b>	↑ 2,5	↑ 2,0	↓ -1,1	↓ -3,7	↓ -3,6
	S1	-10,5	↑ 2,6	↑ 2,0	↓ -1,1	↓ -3,1	↓ -4,1
	S3	-10,2	↑ 2,3	↑ 1,5	-0,7	↓ -3,4	↓ -5,1
	S2	-13,4	↑ 2,6	↑ 2,5	↓ -1,5	↓ -4,6	↓ -1,6
<b>Legend</b>			↑ ↓	Increase > 3 dB, or decrease > 3 dB			
			↑	Increase > 1 dB, or > 10 % (T <sub>20</sub> and EDT)			
			↓	Decrease > 1 dB, or > -10 % (T <sub>20</sub> and EDT)			

**Distribution of sound throughout the pit: open vs. covered**

		MZT	Emp H	Emp L	Dif L fr	Dif H	Abs H	Abs H ce
<b>T<sub>20</sub> [s]</b> (500 -1000 Hz)	Open	1,4	0,7	1,0	0,9	0,8	0,6	0,7
	Covered	1,0	0,8	0,9	0,9	0,7	0,7	0,8
	Difference	-0,4	<b>0,1</b>	0,0	0,0	0,0	0,1	0,0
	<b>Rel. to Emp H</b>			<b>-0,1</b>	<b>-0,1</b>	<b>-0,1</b>	<b>0,0</b>	<b>0,0</b>
<b>EDT [s]</b> (500 -1000 Hz)	Open	1,0	0,6	0,8	0,8	0,7	0,6	0,6
	Covered	0,5	0,6	0,8	0,8	0,6	0,6	0,5
	Difference	-0,6	<b>0,0</b>	0,0	0,0	-0,1	0,0	-0,1
	<b>Rel. to Emp H</b>			<b>0,1</b>	<b>0,1</b>	<b>0,0</b>	<b>0,1</b>	<b>0,0</b>
<b>G [dB]</b> (500 -1000 Hz)	Open	8,8	9,6	10,5	10,3	9,5	8,0	9,6
	Covered	12,2	13,5	13,9	13,5	13,8	12,0	11,8
	Difference	3,4	<b>3,9</b>	3,5	3,2	4,2	4,0	2,2
	<b>Rel. to Emp H</b>			<b>-0,4</b>	<b>-0,7</b>	<b>0,3</b>	<b>0,1</b>	<b>↓ -1,7</b>
<b>G<sub>5-80</sub> [dB]</b> (500 -1000 Hz)	Open	4,7	5,6	7,9	7,0	5,3	3,8	5,0
	Covered	10,4	11,6	11,9	11,2	11,7	10,1	9,6
	Difference	5,7	<b>6,0</b>	3,9	4,2	6,4	6,2	4,6
	<b>Rel. to Emp H</b>			<b>↓ -2,1</b>	<b>↓ -1,8</b>	<b>0,4</b>	<b>0,2</b>	<b>↓ -1,4</b>
<b>LQ<sub>7-40</sub> [dB]</b> (500 -2000 Hz)	Open	-0,6	-1,8	-3,0	-2,3	-1,7	-0,6	-1,1
	Covered	2,4	0,4	-1,0	-1,4	0,2	-0,2	1,7
	Difference	3,1	<b>2,2</b>	2,0	0,9	1,9	0,4	2,8
	<b>Rel. to Emp H</b>			<b>-0,2</b>	<b>↓ -1,2</b>	<b>-0,3</b>	<b>↓ -1,8</b>	<b>0,6</b>